

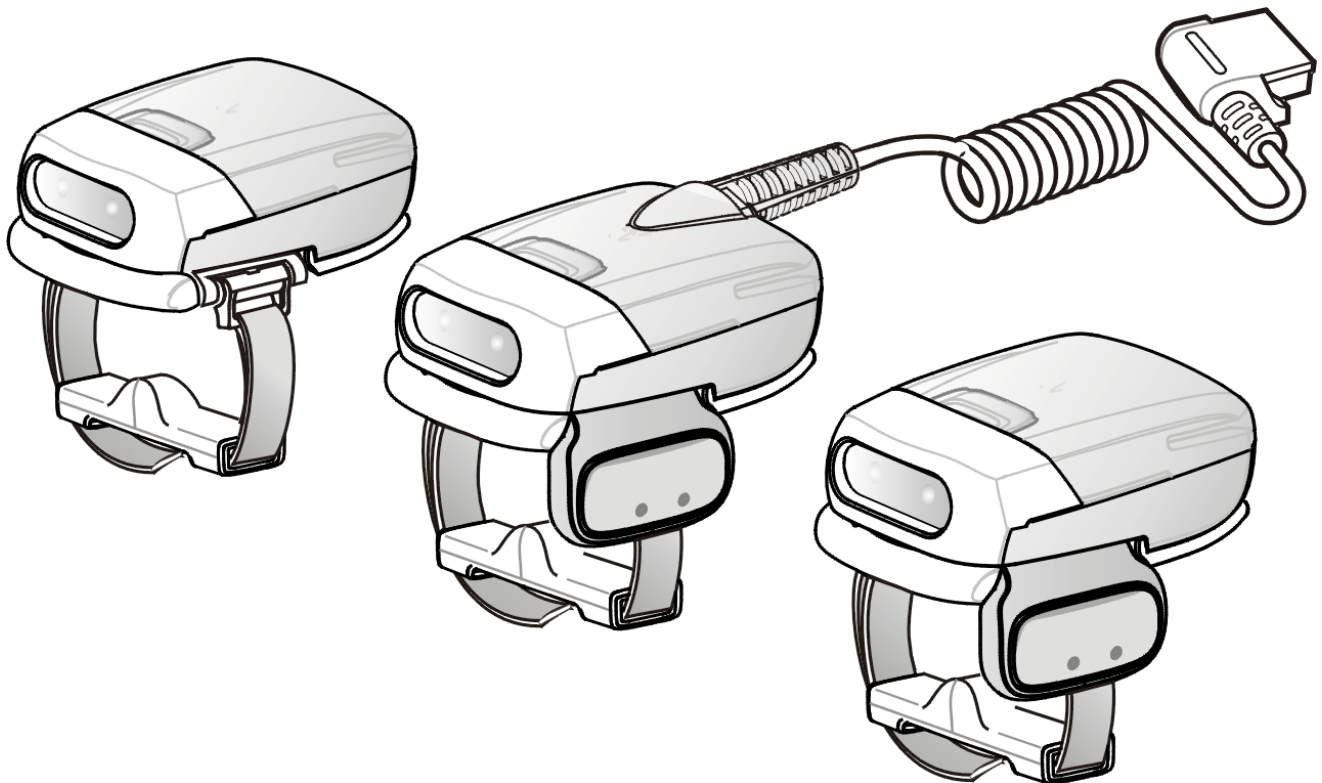

RS507 Hands-Free Imager

Product Reference Guide



***RS507 Hands-Free Imager
Product Reference Guide***

72E-120802-01

Rev. B

September 2011

© 2011 by Motorola, Inc. All rights reserved.

No part of this publication may be reproduced or used in any form, or by any electrical or mechanical means, without permission in writing from Motorola. This includes electronic or mechanical means, such as photocopying, recording, or information storage and retrieval systems. The material in this manual is subject to change without notice.

The software is provided strictly on an “as is” basis. All software, including firmware, furnished to the user is on a licensed basis. Motorola grants to the user a non-transferable and non-exclusive license to use each software or firmware program delivered hereunder (licensed program). Except as noted below, such license may not be assigned, sublicensed, or otherwise transferred by the user without prior written consent of Motorola. No right to copy a licensed program in whole or in part is granted, except as permitted under copyright law. The user shall not modify, merge, or incorporate any form or portion of a licensed program with other program material, create a derivative work from a licensed program, or use a licensed program in a network without written permission from Motorola. The user agrees to maintain Motorola’s copyright notice on the licensed programs delivered hereunder, and to include the same on any authorized copies it makes, in whole or in part. The user agrees not to decompile, disassemble, decode, or reverse engineer any licensed program delivered to the user or any portion thereof.

Motorola reserves the right to make changes to any software or product to improve reliability, function, or design.

Motorola does not assume any product liability arising out of, or in connection with, the application or use of any product, circuit, or application described herein.

No license is granted, either expressly or by implication, estoppel, or otherwise under any Motorola, Inc., intellectual property rights. An implied license only exists for equipment, circuits, and subsystems contained in Motorola products.

Warranty

For the complete Motorola hardware product warranty statement, go to:

www.motorola.com/enterprisemobility/warranty.

Revision History

Changes to the original manual are listed below:

Change	Date	Description
Rev A	10/2009	Release
Rev B	10/2011	Add Chapter 7

Table of Contents

Warranty	ii
Revision History	ii

About This Guide

Introduction	xiii
Documentation Set	xiii
Model Configurations	xiii
Chapter Descriptions	xiv
Notational Conventions	xiv
Related Documents	xv
Service Information	xv

Chapter 1: Getting Started

Introduction	1-1
Unpacking	1-1
Introduction	1-2
Cordless Configuration Features	1-3
Corded Configuration Features	1-4
Trigger Swivel Assembly - Change Trigger Position	1-5
Getting Started - Cordless Configuration	1-6
Charge the Battery	1-6
Install the Battery	1-6
Remove the Battery	1-6
Wearing the Imager	1-6
Getting Started - Corded Configuration	1-7
Connect the Corded Adapter	1-7
Remove the Corded Adapter	1-7
Connect to a WT4090 Wearable Terminal	1-8
Wearing the Imager	1-8
Status Indications	1-10
Imager Standby Mode	1-10
Bluetooth Connection	1-11

Establish Bluetooth Connection	1-11
Restore Lost Bluetooth Connection	1-12
Remove Bluetooth Connection	1-12
Pairing Bar Code Format	1-13
Scan	1-14
Scan Triggering Modes	1-14
Aiming the Imager	1-15
Customize the Imager	1-16
Changing from Triggered to Triggerless Configuration	1-16
Changing Triggerless to Triggered Configuration	1-17
Resetting the Imager	1-17
Warm Boot	1-17
Cold Boot	1-17
Clean Boot	1-17

Chapter 2: SAC5070 8-Bay Battery Charger

Introduction	2-1
Unpacking the Charger	2-1
Parts of the Charger	2-2
Installation	2-3
Tabletop / Shelf Set Up	2-3
Wall Mount	2-4
Inserting the Imager Battery in the Charger	2-5
Charge the Battery	2-5
Battery Age Test	2-6
Charge Status LED	2-6

Chapter 3: Troubleshooting & Maintenance

Introduction	3-1
Troubleshooting	3-1
Imager	3-1
Charger	3-2
Maintenance	3-3
Maintaining the Imager	3-3
Comfort Pad Replacement	3-3
Trigger Swivel Assembly Replacement	3-4
Triggerless Strap Holder Replacement	3-6
Finger Strap Replacement (Trigger Swivel Assembly)	3-7
Finger Strap Replacement (Triggerless Strap Holder)	3-8
Strap Buckle Replacement	3-8
Field Replaceable Parts	3-9
Cleaning the Imager	3-10
Maintaining the Charger	3-10
Operating conditions for the Charger	3-10
Handling the Charger	3-10
Cleaning the Charger	3-10

Chapter 4: RS507 Update and Configuration

Introduction	4-1
Configuring the Imager	4-1
Introduction	4-1
Control Panel Application	4-2
RSMSSample Application	4-3
Imager Attributes	4-7
Imager Motion and Proximity Configuration	4-11
.....	4-14
Real Time Logger	4-15
ScannerLog Application	4-15
Imager Firmware Update	4-18
Required Equipment	4-18
Updating the RS507 Firmware	4-18
Rapid Deployment Client	4-21

Chapter 5: Miscellaneous Imager Options

Introduction	5-1
Scanning Sequence Examples	5-2
Errors While Scanning	5-2
User Preferences/Miscellaneous Options Parameter Defaults	5-2
User Preferences	5-4
Set Default Parameter	5-4
Parameter Bar Code Scanning	5-5
Beep After Good Decode	5-5
Beeper Tone	5-6
Beeper Volume	5-7
Beeper Duration	5-8
Imager Activity Modes	5-9
Picklist Mode	5-10
Fuzzy 1D Processing	5-11
Decoding Illumination	5-12
Low Battery Indication Cycle	5-12
Bluetooth Disconnection Alert Control	5-13
Miscellaneous Scanner Parameters	5-16
Transmit Code ID Character	5-16
Prefix/Suffix Values	5-17
Scan Data Transmission Format	5-18
FN1 Substitution Values	5-19
Scan Data Transmission Format (continued)	5-19
Transmit "No Read" Message	5-20

Chapter 6: Symbologies

Introduction	6-1
Scanning Sequence Examples	6-1
Errors While Scanning	6-2
Symbology Parameter Defaults	6-2
UPC/EAN	6-7

Enable/Disable UPC-A	6-7
Enable/Disable UPC-E	6-7
Enable/Disable UPC-E1	6-8
Enable/Disable EAN-8/JAN-8	6-8
Enable/Disable EAN-13/JAN-13	6-9
Enable/Disable Bookland EAN	6-9
Decode UPC/EAN/JAN Supplementals	6-10
User-Programmable Supplementals	6-13
UPC/EAN/JAN Supplemental Redundancy	6-13
UPC/EAN/JAN Supplemental AIM ID Format	6-14
Transmit UPC-A Check Digit	6-14
Transmit UPC-E Check Digit	6-15
Transmit UPC-E1 Check Digit	6-15
UPC-A Preamble	6-16
UPC-E Preamble	6-17
UPC-E1 Preamble	6-18
Convert UPC-E to UPC-A	6-19
Convert UPC-E1 to UPC-A	6-19
EAN-8/JAN-8 Extend	6-20
Bookland ISBN Format	6-21
UCC Coupon Extended Code	6-22
ISSN EAN	6-22
Code 128	6-23
Enable/Disable Code 128	6-23
Set Lengths for Code 128	6-23
Enable/Disable GS1-128 (formerly UCC/EAN-128)	6-24
Enable/Disable ISBT 128	6-25
ISBT Concatenation	6-26
Check ISBT Table	6-27
ISBT Concatenation Redundancy	6-27
Code 39	6-28
Enable/Disable Code 39	6-28
Enable/Disable Trioptic Code 39	6-28
Convert Code 39 to Code 32	6-29
Code 32 Prefix	6-29
Set Lengths for Code 39	6-30
Code 39 Check Digit Verification	6-31
Transmit Code 39 Check Digit	6-31
Code 39 Full ASCII Conversion	6-32
Code 39 Buffering - Scan & Store	6-32
Code 93	6-35
Enable/Disable Code 93	6-35
Set Lengths for Code 93	6-35
Code 11	6-37
Code 11	6-37
Set Lengths for Code 11	6-37
Code 11 Check Digit Verification	6-39
Transmit Code 11 Check Digits	6-40
Interleaved 2 of 5 (ITF)	6-40
Enable/Disable Interleaved 2 of 5	6-40

Set Lengths for Interleaved 2 of 5	6-41
I 2 of 5 Check Digit Verification	6-43
Transmit I 2 of 5 Check Digit	6-43
Convert I 2 of 5 to EAN-13	6-44
Discrete 2 of 5 (DTF)	6-44
Enable/Disable Discrete 2 of 5	6-44
Set Lengths for Discrete 2 of 5	6-45
Codabar (NW - 7)	6-47
Enable/Disable Codabar	6-47
Set Lengths for Codabar	6-47
CLSI Editing	6-49
NOTIS Editing	6-49
MSI	6-50
Enable/Disable MSI	6-50
Set Lengths for MSI	6-50
MSI Check Digits	6-52
Transmit MSI Check Digit(s)	6-52
MSI Check Digit Algorithm	6-53
Chinese 2 of 5	6-53
Enable/Disable Chinese 2 of 5	6-53
Matrix 2 of 5	6-54
Enable/Disable Matrix 2 of 5	6-54
Set Lengths for Matrix 2 of 5	6-55
Matrix 2 of 5 Redundancy	6-56
Matrix 2 of 5 Check Digit	6-56
Transmit Matrix 2 of 5 Check Digit	6-57
Inverse 1D	6-57
Postal Codes	6-58
US Postnet	6-58
US Planet	6-58
Transmit US Postal Check Digit	6-59
UK Postal	6-59
Transmit UK Postal Check Digit	6-60
Japan Postal	6-60
Australian Postal	6-61
Netherlands KIX Code	6-61
USPS 4CB/One Code/Intelligent Mail	6-62
UPU FICS Postal	6-62
GS1 DataBar	6-63
GS1 DataBar-14	6-63
GS1 DataBar Limited	6-63
GS1 DataBar Expanded	6-64
Convert GS1 DataBar to UPC/EAN	6-64
Composite	6-65
Composite CC-C	6-65
Composite CC-A/B	6-65
Composite TLC-39	6-66
UPC Composite Mode	6-66
Composite Beep Mode	6-67
GS1-128 Emulation Mode for UCC/EAN Composite Codes	6-67

2D Symbologies	6-68
Enable/Disable PDF417	6-68
Enable/Disable MicroPDF417	6-68
Code 128 Emulation	6-69
Data Matrix	6-70
Data Matrix Inverse	6-70
Maxicode	6-71
QR Code	6-71
QR Inverse	6-72
MicroQR	6-72
Aztec	6-73
Aztec Inverse	6-73
Redundancy Level	6-74
Redundancy Level 1	6-74
Redundancy Level 2	6-74
Redundancy Level 3	6-74
Redundancy Level 4	6-75
Security Level	6-76
Intercharacter Gap Size	6-77
Report Version	6-77
Macro PDF Features	6-78
Flush Macro Buffer	6-78
Abort Macro PDF Entry	6-78

Chapter 7: RS507 Bluetooth Connection Using HID and SPP Profiles

Introduction	7-1
RS507 to Computer Bluetooth Connection Modes	7-1
RS507 Important hardware features	7-2
Refreshing Boot Choices	7-3
HID (Human Interface Device) Mode	7-3
How to change to HID mode	7-3
How to format the scanned data	7-4
How to pair and connect with a computer running Windows 7 SP1	7-4
How to pair and connect with a computer running Windows XP SP3 and Bluetooth 2.1	7-6
How to pair and connect with other devices	7-10
Reconnecting	7-10
How to demonstrate HID connection with a computer	7-10
Country keyboard type change	7-11
Connecting multiple RS507 into single device	7-13
Using random PIN code	7-13
How to return to SSI (SCAN) mode	7-16
Serial Port Profile (SPP) Mode	7-18
How to change to SPP mode	7-18
How to format the scanned data the data	7-18
How to pair and connect with a computer running Windows 7 SP1	7-19
How to pair and connect with a computer running Windows XP SP3	7-26
SPP connection with RS507 as a Slave	7-30
How to pair and connect with other devices	7-33
Reconnecting	7-34

How to demonstrate SPP connection with a computer	7-34
Connecting multiple RS507 into single device	7-35
How to return to SSI (SCAN) mode	7-35
Switching between SSI (SCAN), HID and SPP	7-36
Firmware upgrade	7-38
Upgrading using a computer and the PC Tool application	7-38
Retrieving the RS507 log file	7-43
Bluetooth Bar Codes	7-47
Bluetooth Authentication Control	7-47
Bluetooth Automatic Reconnection Control	7-47
Bell Indication Control	7-49
Bluetooth Profile Control	7-54
Bluetooth Pairing Control	7-55
Chapter 8: Specifications	
Technical Specifications	8-1
Imager	8-1
Charger	8-4
Appendix A: Standard Default Parameters	
Standard Default Parameters Table	A-1
Appendix B: Programming Reference	
Symbol Code Identifiers	B-1
AIM Code Identifiers	B-3
Appendix C: Sample Bar Codes	
Code 39	C-1
UPC/EAN	C-1
UPC-A, 100%	C-1
EAN-13, 100%	C-2
Code 128	C-2
Interleaved 2 of 5	C-2
GS1 DataBar-14	C-3
PDF417	C-3
Data Matrix	C-3
Maxicode	C-4
QR Code	C-4
US Postnet	C-4
UK Postal	C-5
Appendix D: Numeric Bar Codes	
Numeric Bar Codes	D-1
Cancel	D-2

Glossary

Index

About This Guide

Introduction

This Product Reference Guide provides additional information that is not covered by the Quick Reference Guide and is helpful for application developers and customers alike.

The Product Reference Guide provides information on operating the Imager for the first time, using the Imager, resetting and capturing data.

The guide also covers issues such as charging and testing the Imager battery, troubleshooting, maintenance, firmware update and configuration of the Imager. Sample bar codes are provided for configuring and testing the Imager.

Documentation Set

The documentation set for the RS507 is divided into guides that provide information for specific user needs.

- **RS507 Hands-Free Imager Quick Start Guide** - describes how to use the Imager.
- **SAC5070 8-Bay Battery Charger Quick Reference Guide** - describes how to use the Imager charger.
- **EMDK Help File** - provides API information for writing applications.
- **Advanced Data Formatting Programmer Guide** - describes how to customiz data before transmission to the host device.

Model Configurations

This guide covers the following model configurations:

- RS507-IM2xxxxSTWR -Triggered RS507 with standard battery
- RS507-IM2xxxxSNWR - Triggerless RS507 with standard battery
- RS507-IM2xxxxENWR -Triggerless RS507 with extended battery
- RS507-IM2xxxxCTWR - Corded and Triggered RS507

For shipping configuration of each model option, refer to [Unpacking on page 1-1](#).

Chapter Descriptions

Topics covered in this guide are as follows:

- [Chapter 1, Getting Started](#) provides information on getting the Imager up and running for the first time, basic instructions for using the Imager and instructions for resetting the Imager and capturing data.
- [Chapter 2, SAC5070 8-Bay Battery Charger](#) provides information on charging and testing the Imager battery.
- [Chapter 3, Troubleshooting & Maintenance](#) provides troubleshooting, cleaning, part replacement and technical specifications for the Imager.
- [Chapter 4, RS507 Update and Configuration](#) provides instructions for firmware update and configuration of the Imager operation.
- [Chapter 5, Miscellaneous Imager Options](#) provides information on programming the Imager to perform various functions, or activating different features.
- [Chapter 6, Symbologies](#) details symbology features and provides programming bar codes for selecting these features.
- [Chapter 7, RS507 Bluetooth Connection Using HID and SPP Profiles](#) describes the Bluetooth connection modes of the RS507 to a personal computer and non-Motorola terminals.
- [Chapter 8, Specifications](#) provides Imager and charger technical specifications.
- [Appendix A, Standard Default Parameters](#) provides a sample of bar codes used for configuring the Imager.
- [Appendix B, Programming Reference](#) provides symbol code characters.
- [Appendix C, Sample Bar Codes](#) provides sample bar codes for Imager testing.
- [Appendix D, Numeric Bar Codes](#) provides a sample of numeric bar codes.

Notational Conventions

The following conventions are used in this document:

- “RS507” refers to the Motorola RS507 Hands-Free Imager.
- “Imager” refers to the Motorola RS507 Hands-Free Imager.
- “Terminal” refers to the Wearable Terminal WT4090 or any mobile computer connected to the Imager.
- “Charger” refers to the SAC5070 8-Bay Battery Charger of the RS507.
- *Italics* are used to highlight the following:
 - Chapters and sections in this and related documents
 - Dialog box, window and screen names
 - Drop-down list and list box names
 - Check box and radio button names
 - Icons on a screen
- **Bold** text is used to highlight the following:
 - Key names on a keypad
 - Button names on a screen or window.

- Bullets (•) indicate:
 - Action items
 - Lists of alternatives
 - Lists of required steps that are not necessarily sequential
- Sequential lists (e.g., those that describe step-by-step procedures) appear as numbered lists.

✓ **NOTE** This symbol indicates something of special interest or importance to the reader. Failure to read the note will not result in physical harm to the reader, equipment or data.



CAUTION This symbol indicates that if this information is ignored, there is a possibility that data or material damage may occur.



WARNING! This symbol indicates that if this information is ignored there is a possibility that serious personal injury may occur.

Related Documents

- *RS507 Hands-Free Imager Quick Start Guide*, p/n 72-115987-01-xx
- *SAC5070 8-Bay Battery Charger Quick Reference Guide*, p/n 72-115989-01-xx
- *WT4090 Quick Start Guide* p/n 72-86717-02 -xx as well as other supported terminals'
- *Enterprise Mobility Developer Kit (EMDK for C and EMDK for .NET)*, available at: <http://support.symbol.com/support/supportcentral/supportcentral.do?id=m1>

For the latest version of this guide and all guides, go to: www.motorola.com/enterprisemobility/manuals.

Service Information

If you have a problem with your equipment, contact Motorola Enterprise Mobility Support for your region. Contact information is available at:

<http://www.motorola.com/enterprisemobility/contactsupport>.

When contacting Enterprise Mobility Support, please have the following information available:

- Serial number of the unit
- Model number or product name
- Software type and version number

The following information should be available when reporting a problem:

- Customer name
- Application used
- Configuration (corded/cordless, trigger/triggerless, standard or extended battery)

- RS507 or Cradle version number
- RS507 CAB file version and OEM version
- Use the [ScannerLog Application on page 4-15](#) to retrieve and E-mail the RS507 log to the support representative
- Occurrence (always, once out of 10 attempts, etc...)
- Suggested steps to reproduce the problem

Motorola responds to calls by E-mail, telephone or fax within the time limits set forth in support agreements.

If your problem cannot be solved by Motorola Enterprise Mobility Support, you may need to return your equipment for servicing and will be given specific directions. Motorola is not responsible for any damages incurred during shipment if the approved shipping container is not used. Shipping the units improperly can possibly void the warranty.

If you purchased your Enterprise Mobility business product from a Motorola business partner, contact that business partner for support.

Chapter 1 Getting Started

Introduction

This chapter describes the features of the RS507 Hands-Free Imager and explains how to install and charge the battery, capture data and reset the Imager.

Unpacking

Carefully remove all protective material from around the equipment and save the shipping container for later storage and shipping.

After opening the shipping box, inspect the contents. You should have received the following:

Table 1-1 RS507 Shipping Configuration Model Options

Model	Description	Standard Battery	Extended Battery	Corded Adapter	Trigger	Quick Reference Guide
RS507-IM2xxxxSTWR	Triggered RS507 with standard battery	x			x	x
RS507-IM2xxxxSNWR	Triggerless RS507 with standard battery	x				x
RS507-IM2xxxxENWR	Triggerless RS507 with extended battery		x			x
RS507-IM2xxxxCTWR	Corded and Triggered RS507			x	x	x

Inspect the equipment for damage. If you are missing any equipment or if you find any damaged equipment, contact the Motorola Enterprise Mobility Support immediately. See [Service Information on page xv](#) for contact information.

Introduction

The RS507 Hands-Free Imager (also referred to as the Imager) is a wearable bar code scan solution for both 1D and 2D bar code symbologies. The Imager is also compatible with a wide range of mobile computers communicating over Bluetooth.

The Imager is designed for a wide range of applications from management of products in a warehouse, to processing deliveries at a courier facility to processing prescription drugs at the pharmaceutical distribution center.

The Imager uses camera-based scanning technology, designed to offer flexible hands-free operation with ergonomic comfort for right or left hand users.

The Imager can be operated in both manual and auto-triggering modes.

Auto-triggering is a patent-pending Interactive Sensing Technology combining motion and proximity sensing for triggering the Imager.

The Imager is built to last and rated for indoor and outdoor daily use in scan-intensive environments. Built on a magnesium chassis, the Imager offers the durability associated with the most rugged mobile computers.

Cordless Configuration Features

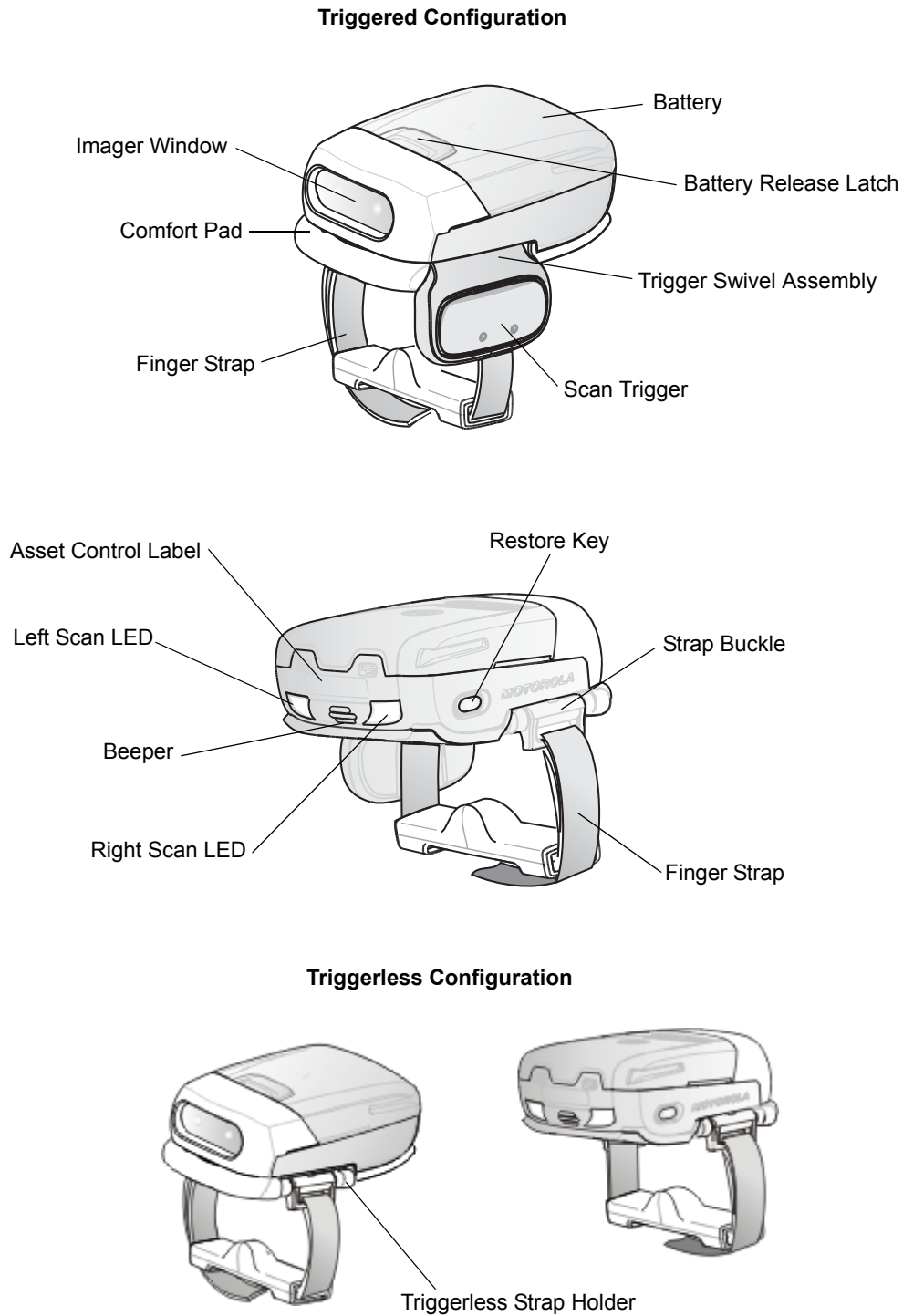

Figure 1-1 RS507 Cordless Configuration Features

Corded Configuration Features

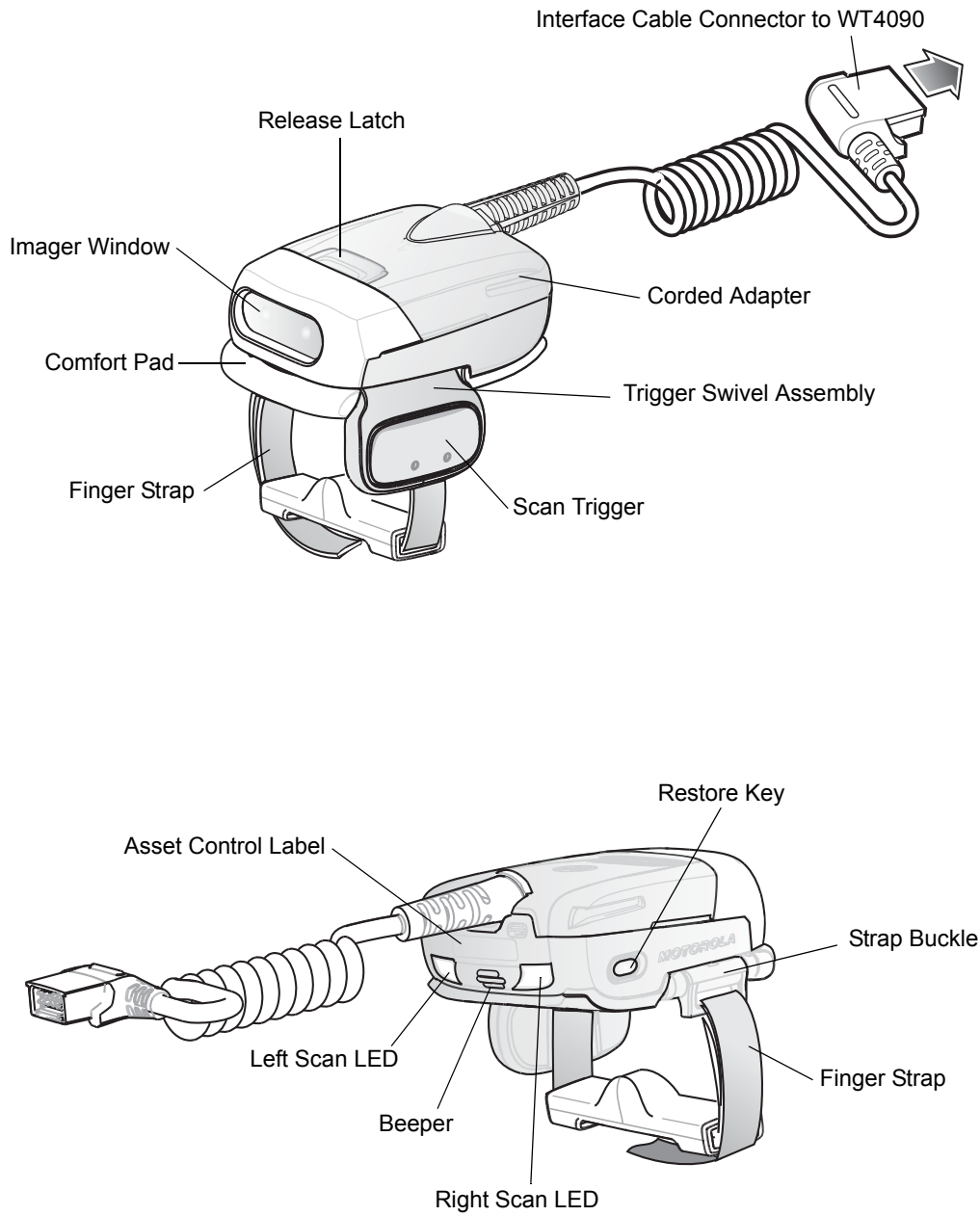

Figure 1-2 RS507 Corded Configuration Features

Trigger Swivel Assembly - Change Trigger Position

The Imager is worn on the index and middle fingers, and triggered with the thumb. The Trigger Swivel Assembly of the Imager rotates to provide left-hand or right-hand use.

To change the position of the Trigger:

1. From the bottom of Imager, hold and pull the Comfort Pad off the Imager.

✓ **NOTE** When removing the Comfort Pad off the Imager, It is not necessary to remove the Finger Strap from the Trigger Swivel Assembly.

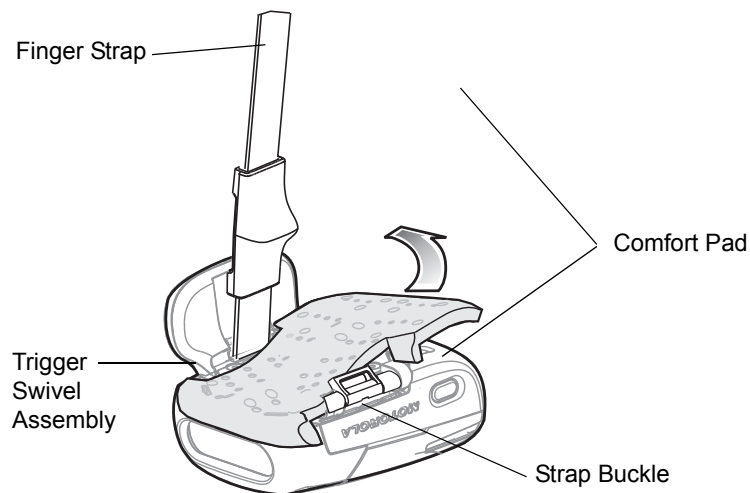

Figure 1-3 Change Trigger Position - Removal of Finger Strap and Comfort Pad

2. Determine whether the Imager is used on the right or left hand and rotate the Trigger Swivel Assembly.

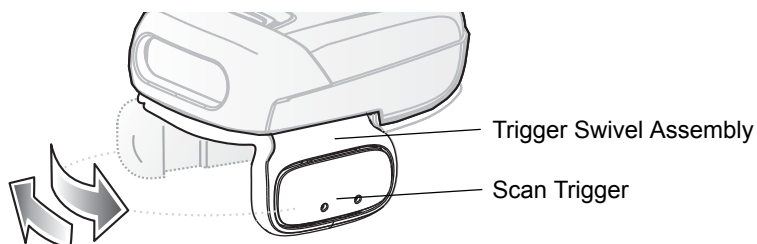

Figure 1-4 Change Trigger Swivel Assembly Position



CAUTION The Trigger Swivel Assembly only rotates 180° around the front of the scan assembly. Do not rotate the Trigger Swivel Assembly past the designed stops.

3. Rotate the Trigger Swivel Assembly so that the Scan Trigger is positioned next to the thumb when the Imager is placed on the index and middle fingers.
4. Position the Comfort Pad onto the Imager.
5. Press the Comfort Pad onto the Imager. When properly installed, the Comfort Pad locks into place.
6. Insert the Finger Strap into the Strap Buckle.

Getting Started - Cordless Configuration

Charge the Battery

Before using the Imager, charge the battery. The SAC5070 8-Bay Battery Charger supports both standard and extended capacity batteries.

To charge the Imager battery, refer to the SAC5070 8-Bay Battery Charger Quick Reference Guide, p/n 72-115989-01 available at: www.motorola.com/enterprisemobility/manuals and search for 'SAC5070'.

Install the Battery

1. Align the battery on top of the Imager.
2. Push the battery all the way into the Locking Slots of the Imager.
3. Firmly press the battery into the Imager until a “click” is heard ensuring the Battery Release Latch is fully engaged with the Imager.

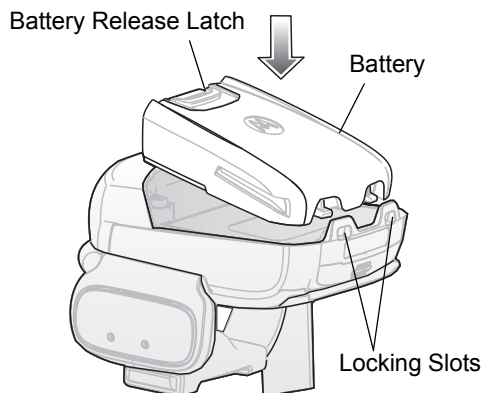

Figure 1-5 Install the Battery

Remove the Battery

1. Hold the Imager in one hand.
2. Press the Battery Release Latch.
3. Pull up the battery to release it from the Locking Slots of the Imager.

Wearing the Imager

1. Slide the Imager onto the index and middle fingers with the Scan Trigger next to the thumb.
2. Tighten the Finger Strap.



NOTE When using the Imager for the first time, press and release the Scan Trigger to enable the manual triggering mode (this operation disables the default auto triggering mode).

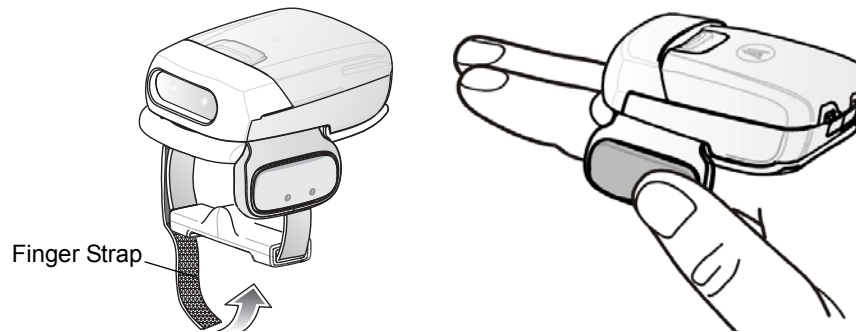

Figure 1-6 *Wearing the Imager - Cordless Adapter*

Getting Started - Coded Configuration

In order to start using the Imager you must install the Coded Adapter.

Connect the Coded Adapter

To connect the Coded Adapter:

1. Align the Coded Adapter on top of the Imager.
2. Support the bottom side of the Imager and push the Coded Adapter all the way into the Locking Slots of the Imager.
3. Firmly press the Coded Adapter into the Imager until a click is heard ensuring the Adapter Release Latch is fully engaged with the Imager.

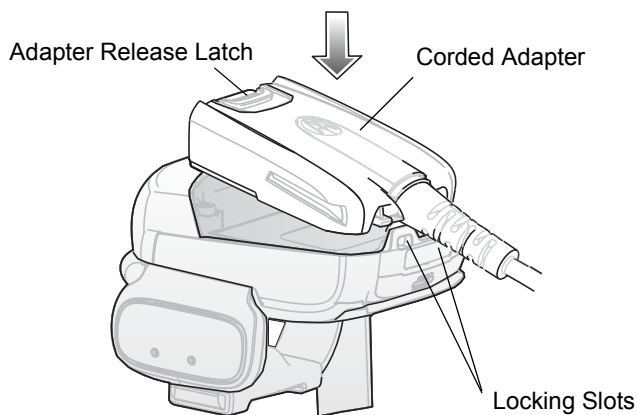

Figure 1-7 *Connect Coded Adapter*

Remove the Coded Adapter

To remove the Coded Adapter:

1. Hold the Imager in one hand.
2. Press the Adapter Release Latch.
3. Pull up the Coded Adapter to release it from the Locking Slots of the Imager.

Connect to a WT4090 Wearable Terminal

The Imager connects to the Wearable Terminal and mounts on the fingers.

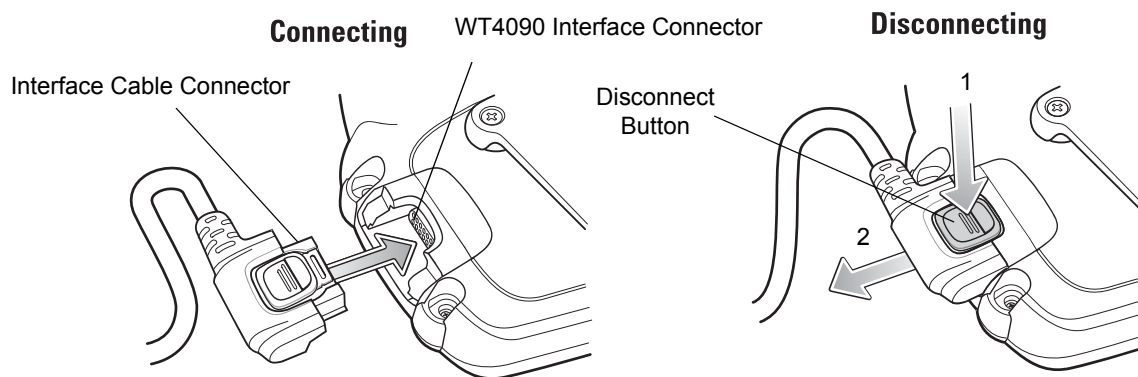

Figure 1-8 Connecting and Disconnecting to a Wearable Terminal

To connect the Imager to the terminal:

1. On the terminal, remove the cover from the WT4090 Interface Connector.
2. Connect the Interface Cable Connector of the Imager to the WT4090 Interface Connector.

To disconnect the Imager from the terminal:

1. Press the Disconnect Button on the Interface Cable Connector.
2. Pull the Interface Cable Connector out of the WT4090 Interface Connector.

Wearing the Imager

To wear the Imager:

1. Slide the Imager onto the index and middle fingers with the Scan Trigger next to the thumb (see [Figure 1-9](#)).

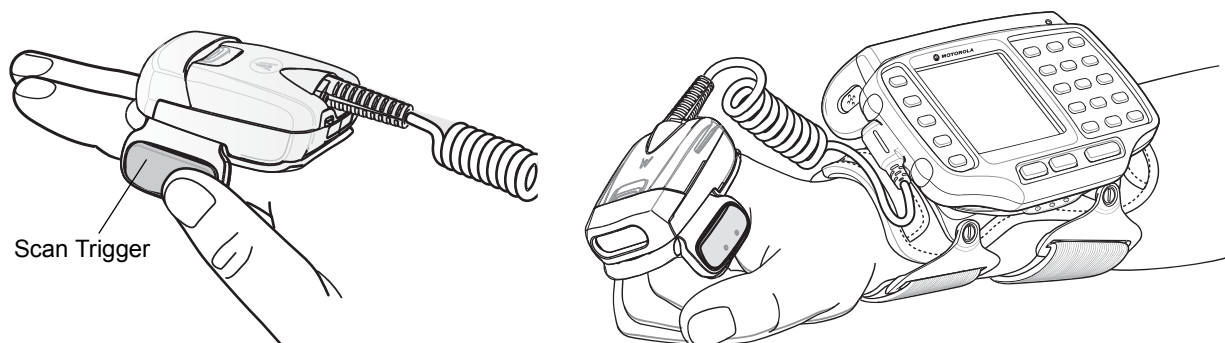

Figure 1-9 Wear the Imager - Corded Adapter

2. Tighten the Finger Strap.

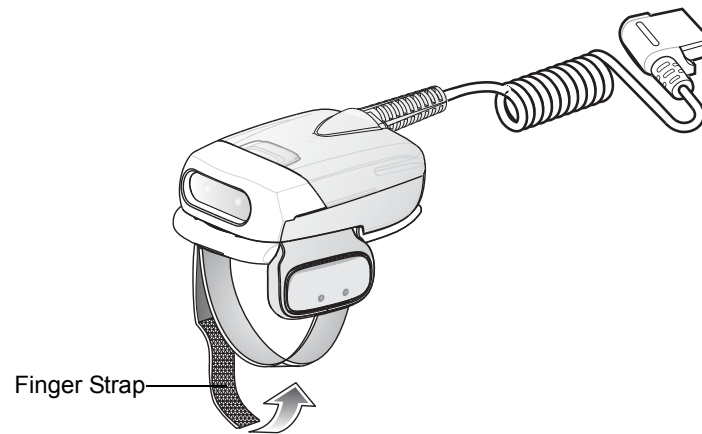

Figure 1-10 *Wear the Corded Adapter Imager - Finger Strap*

- ✓ **NOTE** When using the Imager for the first time, press and release the Scan Trigger to enable the manual triggering mode (this operation disables the default auto triggering mode).

Status Indications

The Imager has two Scan LEDs that provide identical indications. The Imager is also equipped with a beeper that issues different beep sequences and patterns to indicate status.

Table 1-2 defines the LED and beep sequences indications that occur during normal operation and bar code scanning.

Table 1-2 *Status Indications*

No.	LED	Beep Indication	Description
1.	None	High/low	Bluetooth communication is disconnected.
2.	Short green flashes	None	Attempting to connect over Bluetooth.
3.	None	Low/high	Imager is connected over Bluetooth.
4.	None	High/low	Bluetooth communication is disconnected - Imager is out of range.
5.	None	High/low/high/low	Properly decoded scan of Bluetooth pairing bar code.
6.	None	Long low/ long high/	Bluetooth connection attempt failed.
7.	None	Long low/ long high/ Long low/ long high/	Bluetooth connection attempt is rejected.
8.	One green flash	High	Proper scanning indication.
9.	None	4 long beeps	No Bluetooth communication after re-connection failure.
10	Red flash	2 short beeps every 15 seconds	Low battery.
11	Long red flash followed by a green flash	High/low High/low	Clean Boot was performed successfully.



NOTE When the Imager is connected by corded configuration, only "Proper scanning indication" and "Clean Boot was performed successfully" status events are indicated.

Imager Standby Mode

To save battery power, the Imager goes into Standby when not active.

The Imager resumes functionality when:

- Bluetooth data is received from the mobile computer (in cordless configuration)
- Scan trigger is pressed
- Restore key is pressed
- Motion is detected (in cordless configuration)
- Incoming data from mobile computer is sensed (in corded configuration).

Bluetooth Connection

Establish Bluetooth Connection

To establish Bluetooth connection with a mobile computer:

1. Ensure that the Imager is within a range of 10 meters (30 feet) from the mobile computer.
2. Install the battery in the Imager.
3. Launch the Bluetooth Device (BD) address application (see [Figure 1-11](#)) from the mobile computer. Most BD Address applications display a pairing bar code image on the screen of the mobile computer.

✓ **NOTE** To find the BD address application tap the **Start** button and select *Programs > Display_BD_Address* or *Start > Programs > BT Information* and then tap the **Generate Local BD Address Barcode** button to display the BD address bar code.

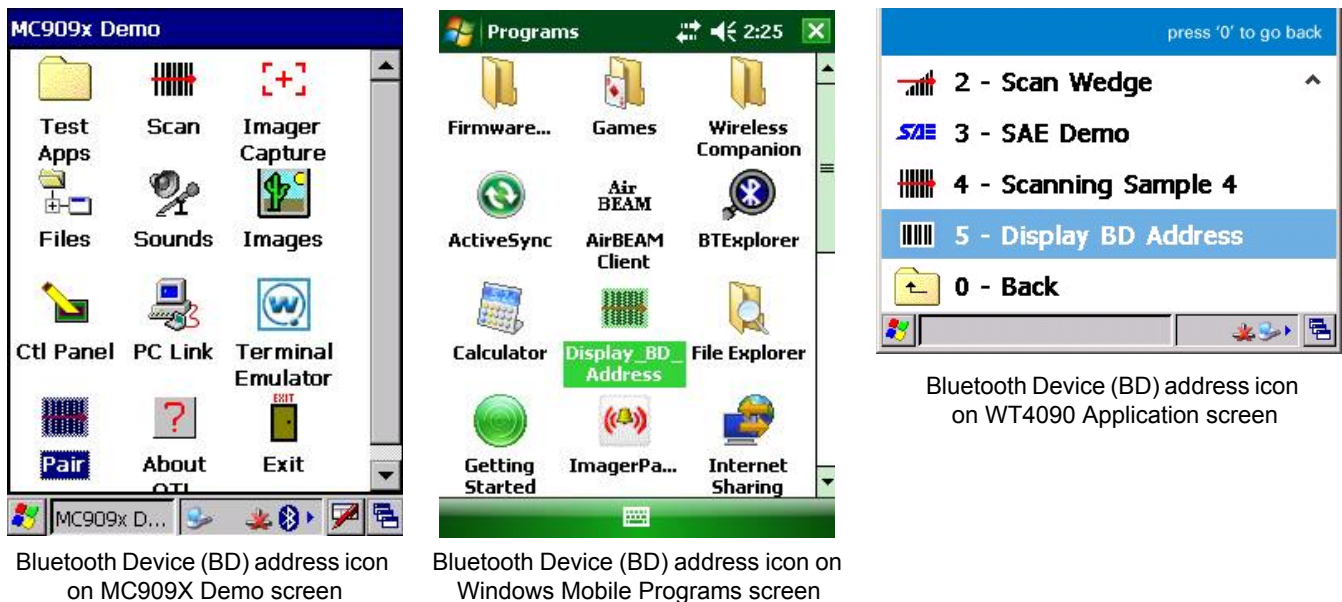

Figure 1-11 Icon of Bluetooth Device (BD) Address Application

4. Scan the pairing bar code on the mobile computer screen (see [Figure 1-12](#)) or a provided pairing label. When scanning, the Imager emits one string of high/low/high/low beeps.

✓ **NOTE** To create printed pairing bar code label, refer to [Pairing Bar Code Format on page 1-13](#).



Figure 1-12 Pairing Bar Code Example as Shown on the Mobile Computer Screen

5. The Scan LED starts flashing green indicating that the Imager is attempting to establish connection with a mobile computer.
 - ✓ **NOTE** If the Imager default PIN code is required for establishing connection, enter the following code: "12345". You may also need to set the authentication and encryption to Enabled.
6. When connection is established, the Scan LED turns off and the Imager emits one string of low/high beeps. The Imager is connected and ready for scanning.
 - ✓ **NOTE** When replacing the Imager battery, the Imager memory retains the pairing information of the last paired mobile computer.

Restore Lost Bluetooth Connection

The Imager maintains Bluetooth communication with a mobile computer within a range of 10 meters (30 feet). When the Imager fails to establish connection or connection is lost during operation, the Imager emits one string of high/low beeps.

To reestablish the Bluetooth connection with a mobile computer:

1. Ensure that the Imager is within a range of 10 meters (30 feet) from the mobile computer.
2. Ensure that the mobile computer is on and "awake" (not in Suspend mode).
3. The Imager automatically attempts reconnecting to the mobile computer for 30 seconds (Scan LED flashes green). If automatic re-connection fails, verify that the Imager is within Bluetooth range and briefly press the Restore Key on the Imager to reconnect.
 - ✓ **NOTE** You can also reconnect by scanning a pairing bar code from the mobile computer screen or provided label. When scanning, the Imager emits one string of high/low/high/low beeps.
4. The Scan LED starts flashing green indicating that the Imager is attempting to establish connection with a mobile computer. The Scan LED turns off and the Imager emits one string of low/high beeps indicating that the Imager is connected and ready for scanning.

Remove Bluetooth Connection

Remove Bluetooth connection to allow the Imager to connect to another mobile computer or to enable the a mobile computer to accept the connection from another Imager.

- ✓ **NOTE** Removing Bluetooth connection is only required if the Imager is configured to auto-connect upon power-up (permanent pairing is enabled) and has to be paired with a different mobile computer.

To remove Bluetooth connection:

1. Scan an un-pairing bar code for disconnecting the Imager from the mobile computer.



Figure 1-13 *Un-pairing Bar Code*

2. The Imager emits one string of high/low beeps indicating that Bluetooth communication with the mobile computer is disconnected.

Pairing Bar Code Format

In order to pair the Imager with a mobile computer over Bluetooth, a pairing bar code must be created. You can use the Display_BD_Address application on the mobile computer, or create and print a pairing bar code label. To create a pairing bar code label, the Bluetooth address of the mobile computer should be available (refer to the mobile computer user guide).

Pairing bar codes are Code 128 or Data Matrix symbologies formatted as follows:

<Fun3>Bxxxxxxxxxxxx

Where xxxxxxxxxxxx represents the 12-character Bluetooth address.

Pairing Bar Code Example

If the mobile computer to which the Imager connects has a Bluetooth address of 11:22:33:44:55:66, then the pairing bar code is:



Pairing Bar Code Content: <Fnc 3> 'B' + Bluetooth Address

Figure 1-14 *Creating a Pairing Bluetooth Bar Code*

Scan

The Imager uses digital camera technology to take an image of a bar code and software decoding algorithms are executed to extract the bar code data from the image.

Scan Triggering Modes

Manual Triggering (Triggered models only)

1. Launch a scanning software application on the mobile computer.
2. Position the Imager approximately 22.8 cm (9 inches) from a bar code and press the Scan Trigger. Position the cross hair laser beam to cover the bar code. The Imager takes a digital picture (image) of the bar code and stores it in memory for decoding.

✓ **NOTE** After battery is inserted or a corded adaptor is connected (on both sides), the first trigger press disables the auto triggering mode.

3. One green flash of the LEDs is given and a high beep sounds to indicate that the bar code was properly decoded.

✓ **NOTE** In some configurations proper decoding of a bar code is indicated by the software application running on the mobile computer.

Auto-triggering (Triggerless models only)

The Imager is provided with auto-triggering capability. In auto-triggering mode, both motion and proximity sensors are used to trigger the Imager when the user intends to scan a bar code.

With auto-triggering activated, the Imager automatically scans when motion stops and a bar code is placed within the depth of field of the Imager. The Imager scans the bar code and turns off to conserve power.

To scan a bar code in auto-triggering mode:

1. Position the Imager approximately 22.8 cm (9 inches) from a bar code.
2. Aim at the bar code.
3. The Imager takes a picture (image) of the bar code and stores it in memory for decoding.
4. One green flash of the Scan LEDs and a high beep indicates that a bar code was properly decoded.

✓ **NOTE** In some applications, proper detection of a bar code is indicated by a software application running on the mobile computer.

Aiming the Imager

The aiming pattern of the Imager is a cross hair laser beam with bright center dot (see [Figure 1-15](#)). The virtual rectangle made by the cross hair reflects the field of view of the Imager. The aiming pattern is used to position the bar code within the field of view.

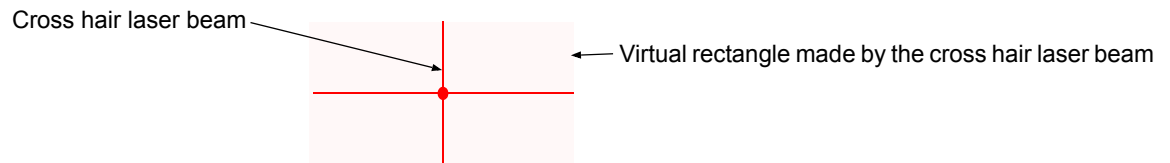

Figure 1-15 *Cross Hair Laser Beam*

Enter the symbol in any orientation within the virtual rectangle made by the cross hair laser beam, making use of its omnidirectional reading capability within the entire field of view.

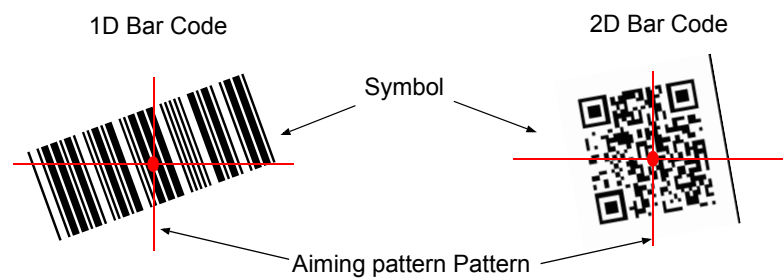

Figure 1-16 *Symbol Scan Orientation*

The Imager can also read a bar code presented within the aiming pattern but not centered (see the top bar codes on [Figure 1-17](#)). The bar codes marked with X in [Figure 1-17](#), however, show bar code aiming that may result in no decode.

When using the application on your mobile computer in “Pick List” mode, the Bright Center Dot can be positioned anywhere on the symbol (see [Figure 1-15](#)). The top examples in [Figure 1-17](#) show acceptable aiming options, while the bottom examples can not be decoded.

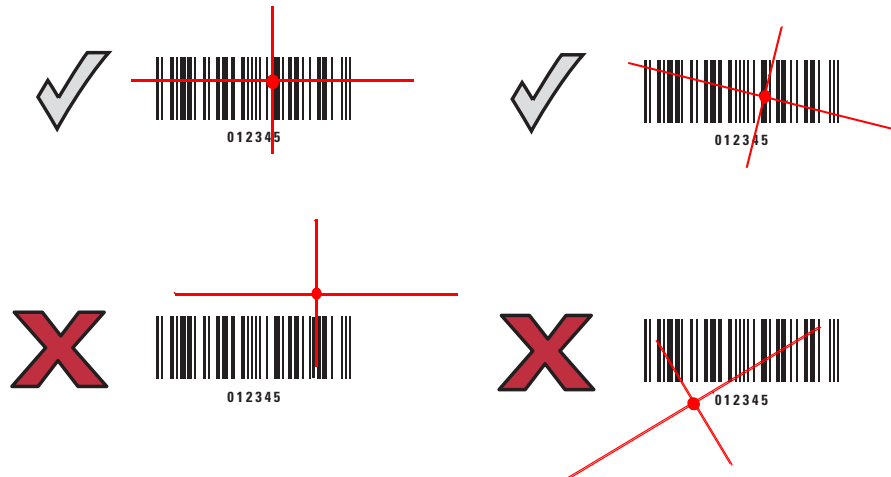

Figure 1-17 Acceptable Aiming Options

The aiming pattern is smaller when the Imager is closer to the symbol and larger when it is farther from the symbol. Scan symbols with smaller bars or elements (mil size) closer to the Imager and those with larger bars or elements (mil size) farther from the Imager.

1. Hold the Imager between two and eleven inches from the bar code (depending on the bar code density).

✓ **NOTE** When a symbol is under transparent plastic or on a mobile computer screen, it is recommended to use a tilt (pitch) or skew scan angle to minimize reflection.

2. Press the Scan trigger. The aiming pattern illuminates red indicating that the laser is on. One green flash of the Scan LED and a high beep indicates that a bar code was properly decoded.

Customize the Imager

Changing from Triggered to Triggerless Configuration

To change from Triggered to Triggerless configuration:

1. Remove the Comfort Pad (see [Comfort Pad Replacement on page 3-3](#)).
2. Remove the Trigger Swivel Assembly (see [Trigger Swivel Assembly Replacement on page 3-4](#)).
3. Install the Triggerless Strap Holder (see [Triggerless Strap Holder Replacement on page 3-6](#)).
4. Install the Comfort Pad (see [Comfort Pad Replacement on page 3-3](#)).
5. Perform a cold boot (see [Cold Boot on page 1-17](#)).

Changing Triggerless to Triggered Configuration

To change from Triggerless to Triggered configuration:

1. Remove the Comfort Pad (see [Comfort Pad Replacement on page 3-3](#)).
2. Remove the Triggerless Strap Holder (see [Triggerless Strap Holder Replacement on page 3-6](#)).
3. Install the Trigger Swivel Assembly (see [Trigger Swivel Assembly Replacement on page 3-4](#)).
4. Install the Comfort Pad (see [Comfort Pad Replacement on page 3-3](#)).
5. Perform a cold boot (see [Cold Boot on page 1-17](#)).
6. Press and release the Scan Trigger to enable the manual triggering mode (this operation disables the default Triggerless mode).

Resetting the Imager

If the Imager stops responding to input, reset it. There are three reset functions, warm boot, cold boot and clean boot. Perform a warm boot first. If the Imager still does not respond, perform a cold boot. Perform clean boot to restore the Imager to its factory default configuration.

Warm Boot

To perform warm boot, press and hold the Restore Key for more than six seconds.

Cold Boot

Cold boot restores the Imager's operation by resetting its software. To perform cold boot, remove and re-insert the battery into the Imager. When using a corded Imager model with WT4090, remove and reconnect the interface cable that connects between the Imager and the WT4090.

Clean Boot

Clean Boot restores the Imager to its factory default configuration.

To perform clean boot:

1. Remove battery or disconnect the Corded Adapter.
2. Press and hold the Restore Key.
3. Insert the battery or Corded Adapter into the Imager.
4. Continue to press and hold the Restore Key for about five seconds until a chirp is heard and the Scan LEDs flash green. The Imager is now in its factory default configuration.

✓ **NOTE** The factory default configuration is set in the factory or the service center. These parameters are unique for each Imager and cannot be changed. The Factory default configuration includes: Imager serial number, Bluetooth Device (BD) address, model number, production date and proximity calibration.

Chapter 2 SAC5070 8-Bay Battery Charger

Introduction

The SAC5070 8-Bay Battery Charger is an accessory for the RS507 Hands-free Imager and provides a quick way to recharge the Lithium-ion battery that provide power for the RS507 Hands-Free Imager. One charger can hold up to eight batteries at a time.

The 8-Bay Battery Charger supports both standard and extended capacity batteries. The Charger may only be used indoors.

Unpacking the Charger

After opening the shipping box, inspect the contents. You should have received the following:

Model	Description	8-Bay Battery Charger	Power supply	AC Line Cord	Quick Start Guide
SAC5070-800CR	USA model	X	X	X	X
SAC5070-801CR	International model	X	X	*	X

* For AC line cord, contact the Motorola representative in your country.

Inspect the equipment for damage. If you are missing any equipment or if you find any damaged equipment, contact Motorola Enterprise Mobility Support immediately.

Parts of the Charger

Charger Front

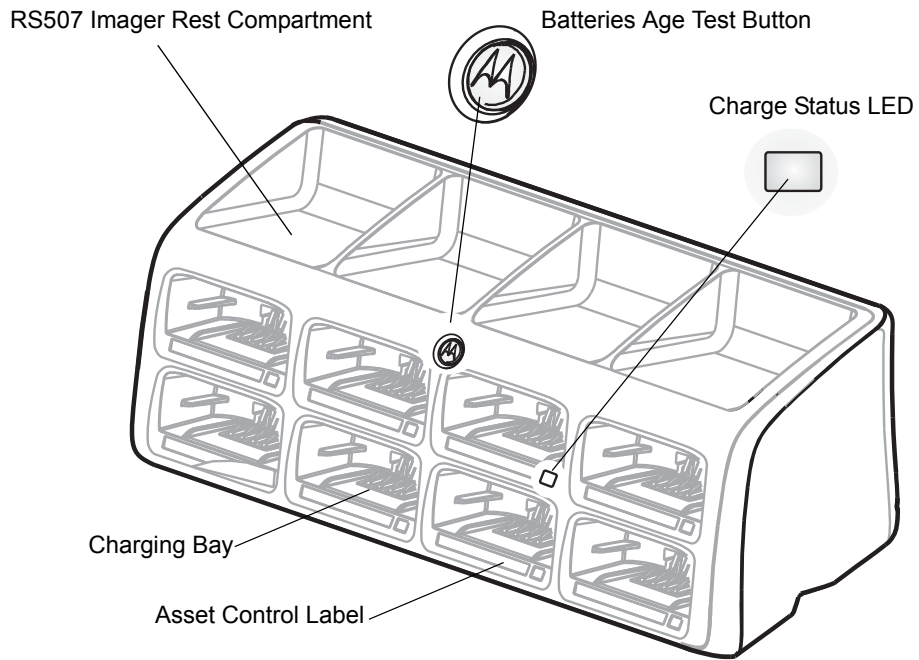

Charger Back

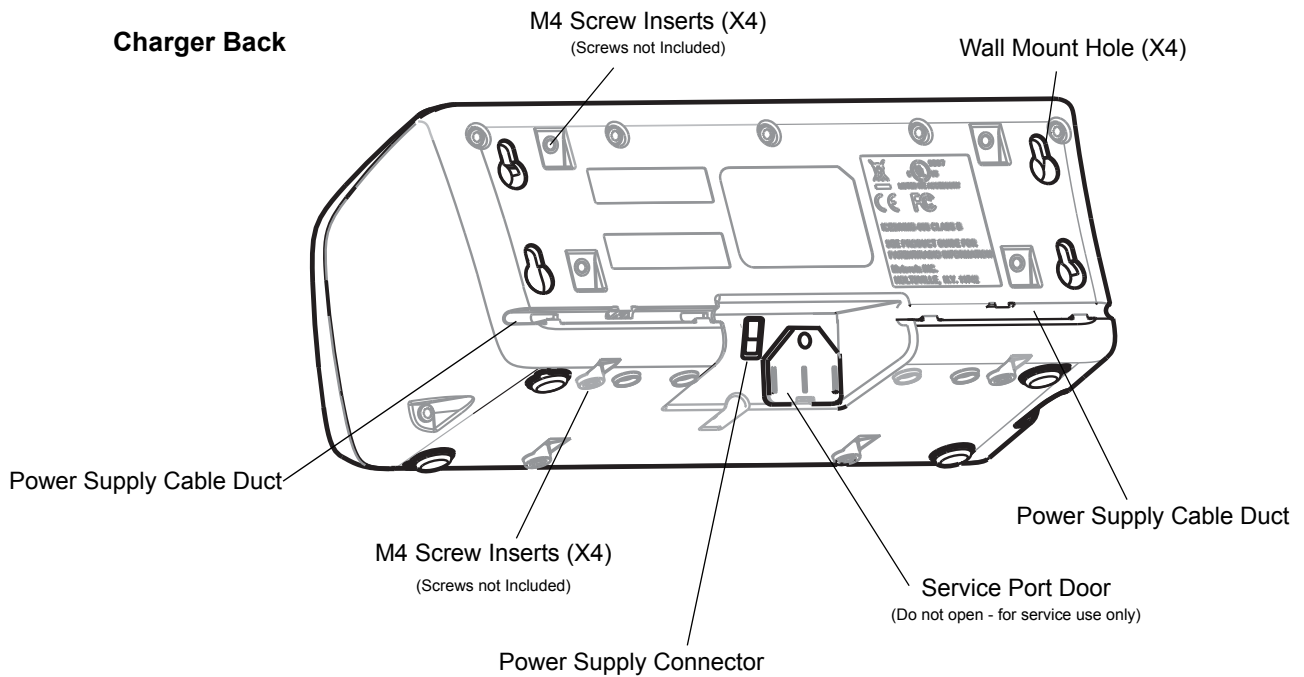

Figure 2-1 Parts of the Charger

Installation

Tabletop / Shelf Set Up

To set the Charger on a tabletop or shelf:

1. Place the Charger and the Power Supply Unit on a tabletop or shelf.

✓ **NOTE** When required, use the screw inserts at the back and base to secure the Charger to the tabletop or shelf surface.

2. Connect the Power Supply Cable to the power connector on the back of the Charger.
3. Use the Power Supply Cable Duct, on the back of the Charger, to route the Power Supply Cable to the left or right side of the Charger.
4. Connect the AC plug of the AC Power Cord to a standard electrical outlet.

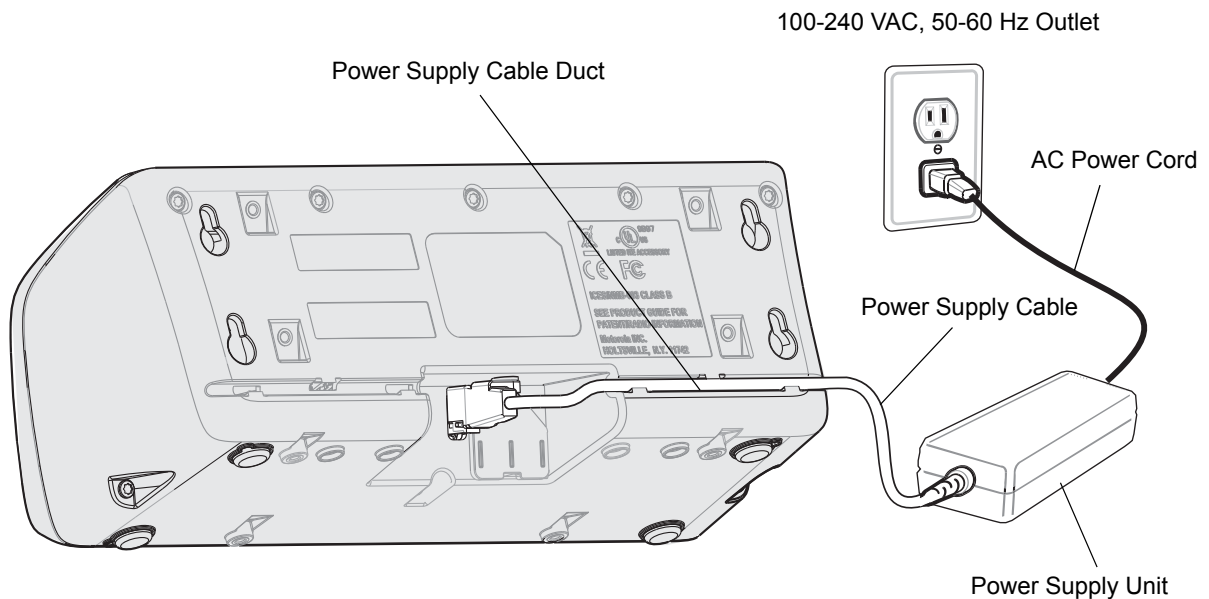

Figure 2-2 Charger Installation

Wall Mount



WARNING! For safe mounting, it is essential to use wall anchors appropriate to the wall type (i.e. plaster, drywall, concrete, etc.). Mount to wood studs whenever possible.

To mount the Charger on a wall:

1. Mark the screw location on the wall.
2. Use four screws to mount the Charger to a wall. Be sure to use additional wall mounting hardware, as needed, for safe mounting according to the wall type.
3. Connect the power supply cable to the power connector on the back of the Charger (see [Figure 2-3](#)).
4. Use the Power Supply Cable Duct, on the back of the Charger, to route the Power Supply Cable to the left or right side of the Charger.
5. Place the Power Supply Unit on a shelf or tabletop.
6. Connect the AC plug of the AC Power Cord to a standard electrical outlet.

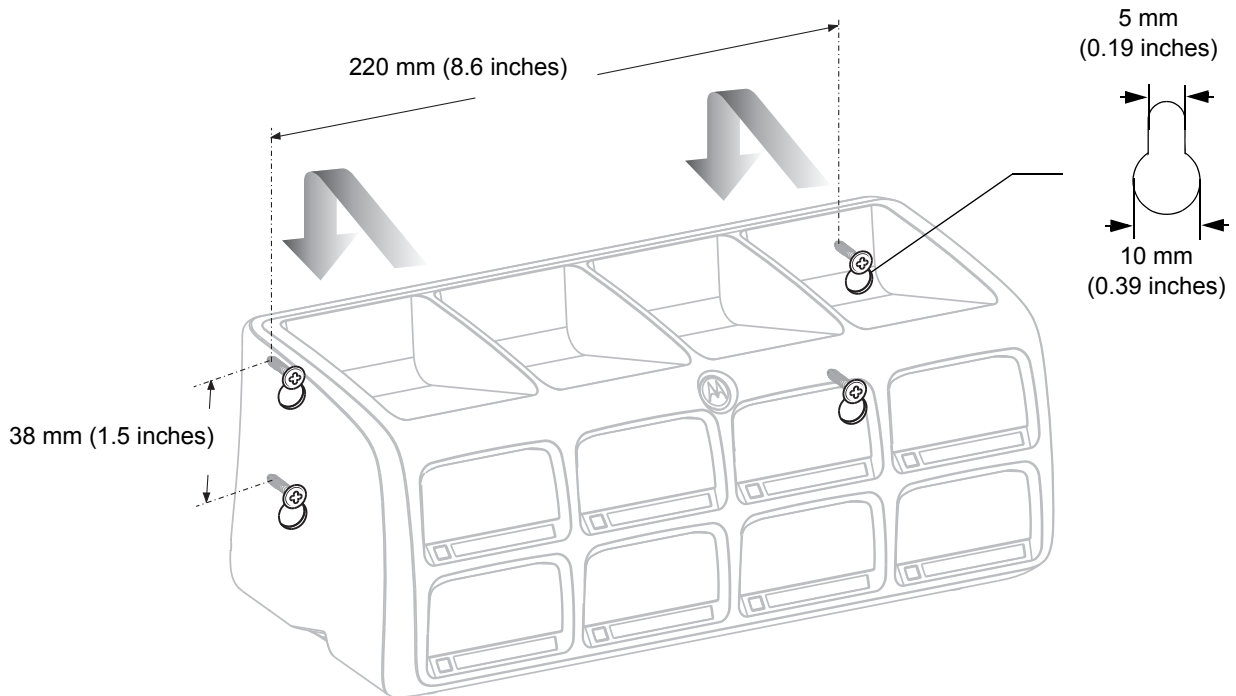

Figure 2-3 Wall Mounting of Charger

Inserting the Imager Battery in the Charger

The Charger supports both standard and extended capacity batteries.

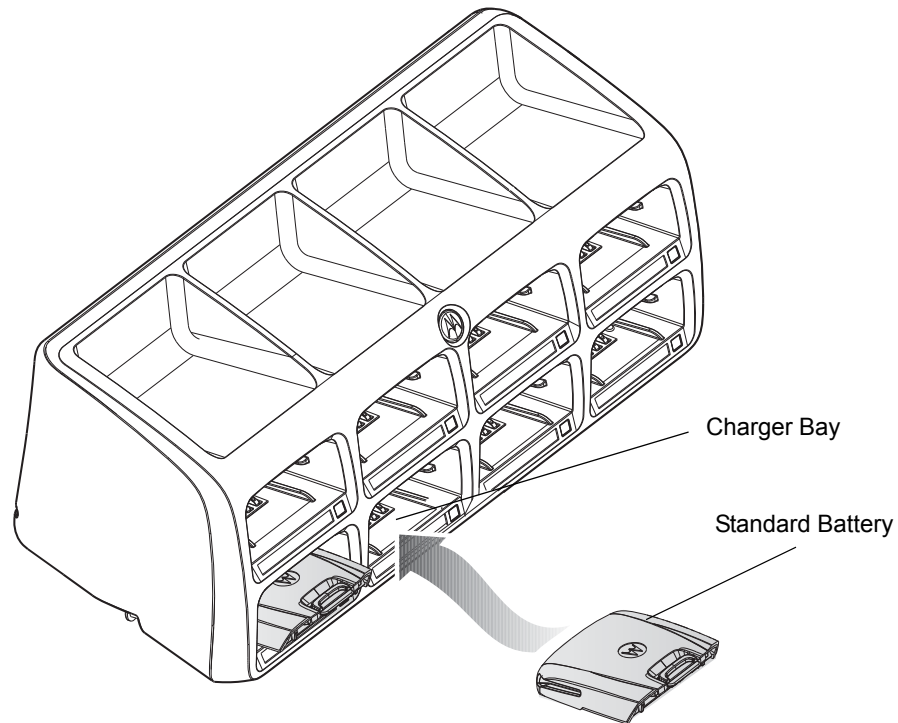

Figure 2-4 Inserting the Imager Battery into the Charger

Charge the Battery



CAUTION Only Lithium-ion batteries that have been designed for use with the RS507 Hands-free Imager can be recharged by the Charger. Do not attempt to recharge other types of rechargeable batteries or any type of batteries. Doing so could destroy those batteries and damage the Charger.



NOTE Batteries should be charged within the 0°C (+32°F) and +40°C (+104°F) ambient temperature range.

To charge the battery(s):

1. Insert the battery(s) into the 8-Bay Battery Charger so that the contacts of the battery are first to enter, facing down, gently. Do not use excessive force.
2. The 8-Bay Battery Charger starts to charge automatically. On each bay, the flashing amber Charge Status LED (see [Figure 2-1](#)) indicates the charge status.

A full charge of a depleted battery takes up to four hours. The Charge Status LED lights solid amber when the battery is fully charged.

Battery Age Test

The battery age test checks the battery capacity when fully charged. A worn-out battery is considered to have less than 80% of its nominal capacity. The battery test is simultaneously performed for all batteries inserted into the charger. It is recommended to perform battery age testing once a month. The age test may take up to 16 hours.

✓ **NOTE** A battery removed during test and re-inserted is excluded from the test but continues normal charging.

To test the battery(s):

1. Insert one or more batteries into Charging Bay(s).
2. Press and hold the Test Button for approximately 3 seconds until the Charge Status LED of each active bay flashes green.
3. Refer to the table below when the indication of the Charge Status LED changes.

Charge Status LED

The Charge Status LEDs show the charge status of each Charging Bay:

Table 2-1 Charge LED - Status Indications

LED Indication	Status
Flashing amber	Charging in progress.
Solid amber	Charging is completed.
Flashing green	Battery age testing in progress.
Flashing red/green	Defective battery or error in charging; re-insert the battery into the bay.
Solid green	Battery age test and charge are completed. Battery is good.
Solid red	Battery age test and charge are completed. Battery capacity is marginal.
Flashing red	Battery age test and charge are completed. Battery is worn out.

Chapter 3 Troubleshooting & Maintenance

Introduction

This chapter provides suggested Imager and Charger troubleshooting and maintenance.

Troubleshooting

Imager

Table 3-1 *Imager Troubleshooting*

Problem	Cause	Solution	
Laser aiming pattern does not display when pressing the Scan Trigger.	Corded: Interface cable is not secure.	Verify that the interface cable is properly connected.	
	Cordless: Battery is not charged.	Replace or charge battery.	
	Power is not applied to Imager.	Corded: Verify that the mobile computer has a fully charged battery installed.	
		Cordless: Replace or charge Imager battery.	
	Scan application on the mobile computer is not functioning.		Restart the scanning application on the mobile computer.
Imager does not respond.		Reset the Imager (See Resetting the Imager on page 1-17).	

Table 3-1 Imager Troubleshooting

Problem	Cause	Solution
Imager does not decode a bar code.	Bar code is unreadable.	Verify that the bar code is not defective, i.e., smudged or damaged.
	Exit window is dirty.	Clean exit window with a lens tissue. Tissues for eyeglasses work well. Do not use tissues coated with lotion (see Cleaning the Imager on page 3-10).
	Bar code symbology is not supported or enabled.	See your system administrator.
	Cordless: Bluetooth link is disconnected.	Reestablish Bluetooth connection (See Establish Bluetooth Connection on page 1-11).

✓ **NOTE** If after performing these checks the Imager still experiences problems, contact the distributor or call Motorola Enterprise Mobility Support. See [Service Information on page xv](#).

Charger

Table 3-2 Charger Troubleshooting

Problem	Solution
The Power LED does not light	Make sure the Power plug of the Power Supply Unit is plugged into a wall outlet and the connector on the end of the Power Supply Cable is plugged into the Charger's power connector.
	Plug the Power plug of the Power Supply Unit into another outlet.
	Replace the Power Supply Unit.
	Contact a service representative (see Service Information on page xv).
The battery takes too long to recharge	Ensure that room/battery temperatures are within charging range 0 °C to +40 °C (+32 °F to +104 °F).
	Clean the contacts on the battery (see Cleaning the Charger on page 3-10).
	Try another battery to make sure the Charger functions properly. (If the charge time is more than four hours the Charge Status LED flashes red/green.)
	Contact a service representative (see Service Information on page xv).
LED indication continuously changes from red to green	Remove and re-insert the battery into the charging bay.
	Check for dirt on battery charging contacts and/or charging bay contacts (see Cleaning the Charger on page 3-10).
	Replace battery with a new one.
	Contact a service representative (see Service Information on page xv).

✓ **NOTE** If after performing these checks the Charger still experiences problems, contact the distributor or call Motorola Enterprise Mobility Support. See page xv for contact information.

Maintenance

Cleaning the scan window is the basic maintenance required. A dirty window can affect scanning accuracy.

- Do not allow abrasive material to touch the window.
- Remove any dirt particles with a damp cloth.
- Wipe the window using a tissue moistened with ammonia/water.
- Do not spray water or other cleaning liquids directly into the window.

Maintaining the Imager

Comfort Pad Replacement

Removal

To remove the Comfort Pad: from the bottom of the Imager, hold and pull the Comfort Pad out of the Imager.

- ✓ **NOTE** It is not necessary to remove the Finger Strap from the Trigger Swivel Assembly.

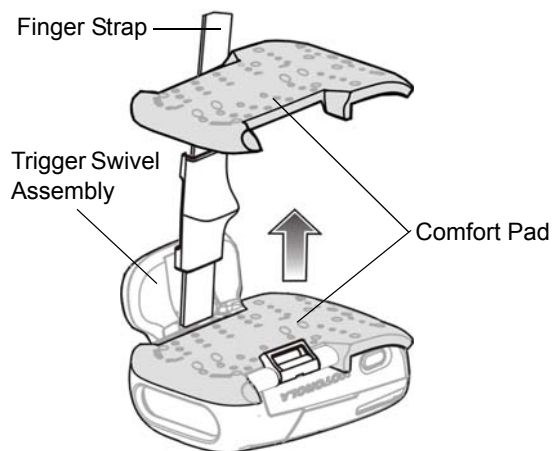

Figure 3-1 Removal of Comfort Pad

Installation

To install the Comfort Pad:

1. Position the Comfort Pad onto the Imager as shown.

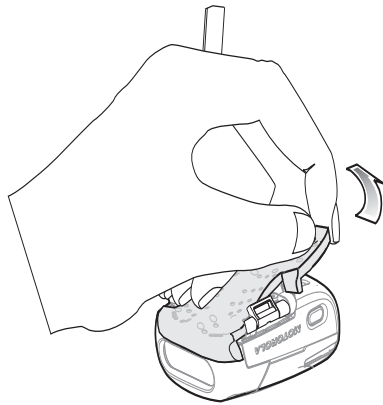

Figure 3-2 *Installation of Comfort Pad*

2. Press the Comfort Pad onto the Imager. When properly installed, the Comfort Pad locks into place.

Trigger Swivel Assembly Replacement

Removal

To remove the Trigger Swivel Assembly:

1. Turn the Imager upside-down.
2. Remove the Comfort Pad.
3. Use a paper clip or similar object to press the Release Latch.

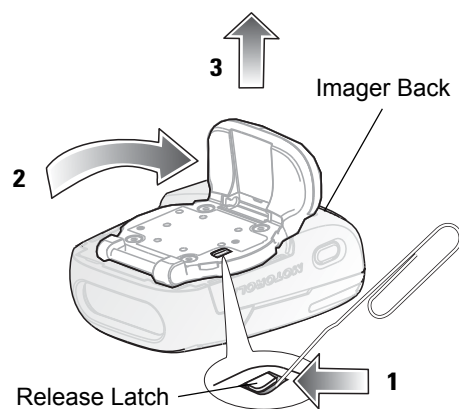

Figure 3-3 *Removal of Trigger Swivel Assembly*

4. Rotate the Trigger Swivel Assembly to align with the back of the Imager.
5. Lift the Trigger Swivel Assembly off the scan assembly.

Installation

To install the Trigger Swivel Assembly:

1. Turn the Imager upside-down.
2. Position the Trigger Swivel Assembly to align with the back of the Imager.
3. Lower the Trigger Swivel Assembly onto the scan assembly.

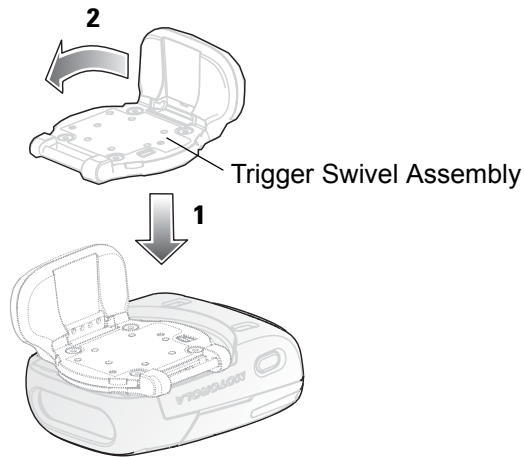

Figure 3-4 *Installation of Trigger Swivel Assembly*

1. Rotate the Trigger Swivel Assembly 1/4 turn counterclockwise.
2. Press the Comfort Pad onto the Imager. When properly installed, the Comfort Pad locks into place.

Triggerless Strap Holder Replacement

- ✓ **NOTE** The Triggerless Strap Holder should be installed when the Imager is intended to be used in Motion and Proximity Initiated bar code read mode.

Removal

To remove the Triggerless Strap Holder:

1. Turn the Imager upside-down.
2. Remove the Comfort Pad.
3. Use a paper clip or similar object to press the Release Latch.

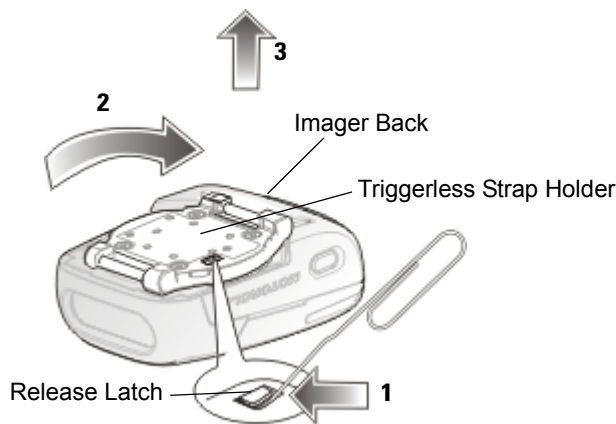

Figure 3-5 Removal of Triggerless Strap Holder

4. Rotate the Triggerless Strap Holder to align with the back of the Imager.
5. Lift the Triggerless Strap Holder off the Imager.

Installation

To install the Triggerless Strap Holder:

1. Position the Triggerless Strap Holder to align with the back of the Imager.

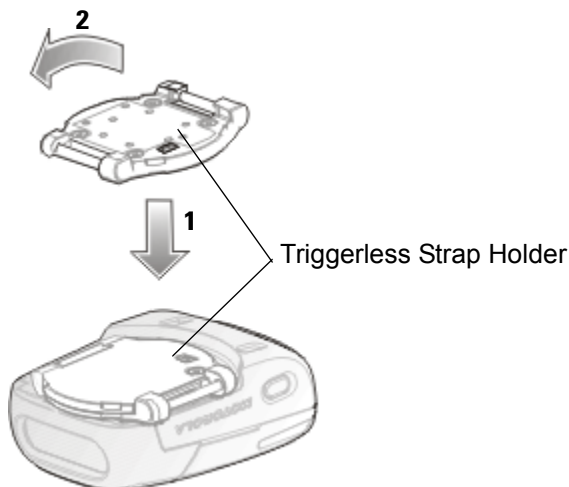

Figure 3-6 Turn the Imager upside-down. Installation of Triggerless Strap Holder

1. Lower the Triggerless Strap Holder onto the Imager.
2. Rotate Triggerless Strap Holder 1/4 turn counterclockwise.

Finger Strap Replacement (Trigger Swivel Assembly)

Removal

1. Remove the Finger Strap from the Strap Buckle.
2. Pull the Finger Strap out of the Trigger Swivel Assembly.

Installation

1. Align a new Finger Strap with the Slots in the Trigger Swivel Assembly.

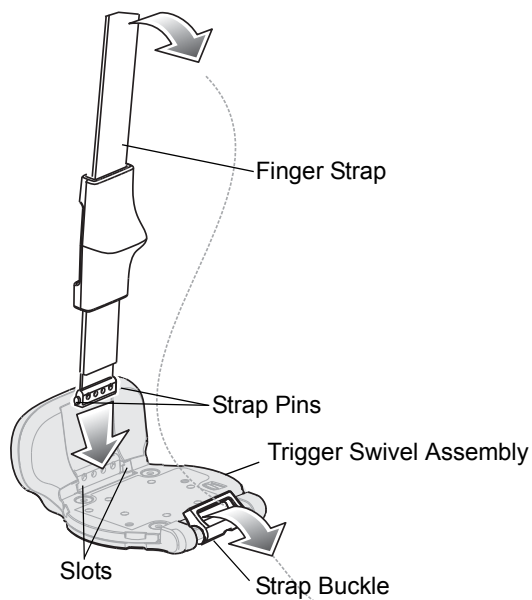

Figure 3-7 *Finger Strap Replacement (Trigger Swivel Assembly)*

2. Gently press the Strap Pins to engage with the Slots of the Trigger Swivel Assembly. The Strap Pins snap into the slots.
3. Slip the Finger Strap through the Strap Buckle.

Finger Strap Replacement (Triggerless Strap Holder)

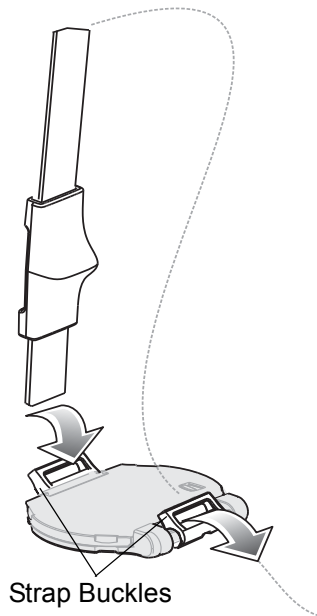

Figure 3-8 Replacement of Finger Strap (Triggerless Strap Holder)

Removal

Remove the Finger Strap from the Strap Buckles.

Installation

Slip the Finger Strap through the Strap Buckles.

Strap Buckle Replacement

Figure 3-9 Strap Buckle Replacement

Removal

1. Remove the Trigger Swivel Assembly (see [Trigger Swivel Assembly Replacement on page 3-4](#)).
2. Press the Strap Buckle off the Trigger Swivel Assembly Pin.

Installation

1. Align the pin slot of Strap Buckle with the pin of the Trigger Swivel Assembly.

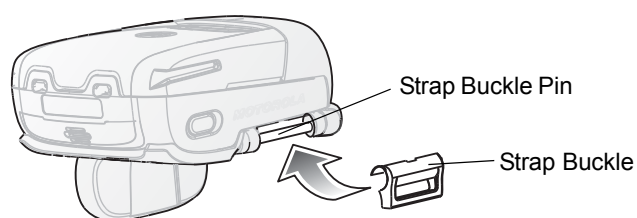

Figure 3-10 Strap Buckle Replacement

2. Gently press the pin slot of Strap Buckle to engage with the pin of the Trigger Swivel Assembly. The pin slot snaps onto the pin.
3. Install the Trigger Swivel Assembly (see [Trigger Swivel Assembly Replacement on page 3-4](#)).

Field Replaceable Parts

Table 3-3 Imager Field Replaceable Parts

No	Part	Description
1	KT-CLMPT-RS507-01R	Trigger Swivel Assembly
2	KT-BKL-RS507-10R	Set of 10 Strap Buckles
3	KT-CLMPN-RS507-01R	Triggerless Strap Holder
4	KT-PAD-RS507-10R	Set of 10 Comfort Pads
5	KT-STRPN-RS507-10R	Set of 10 Triggerless Finger Strap with Finger Support
6	KT-STRPT-RS507-10R	Set of 10 Trigger Finger Strap with Finger Support
7	KTBTRYRS50EAB00-01	Standard Battery
8	KTBTRYRS50EAB02-01	Extended Battery
9	ADPTRWT-RS507-R	Corded Adapter

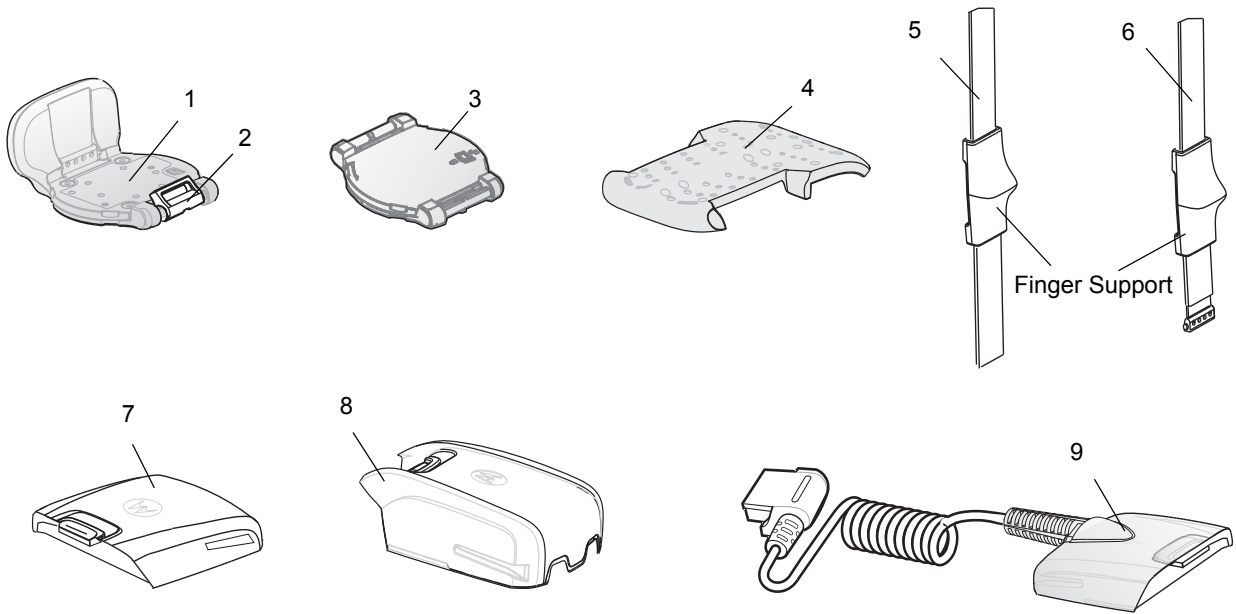

Figure 3-11 Imager Field Replaceable Parts

Cleaning the Imager

Wipe the exit window periodically with a lens tissue or other material suitable for cleaning eyeglasses.



CAUTION Do not pour, spray, or spill any liquid on the Imager.

The gold plated battery contacts do not tarnish or oxidize. No maintenance should be needed. If the contacts need to be cleaned:

1. Wet the tip of a cotton swab with isopropyl alcohol and squeeze the excess alcohol from the swab.
2. Wipe the metal contacts with the damp swab.

Maintaining the Charger

The Charger is well constructed and durable; however, it is a precision electronic device and must be treated as such.

Follow the procedures in this section to ensure reliable service.

Operating conditions for the Charger

The Charger is designed to operate in environments that are normally free of dust, dirt, and moisture. It can be operated at temperatures between 0°C (+32°F) and +40°C (+104°F).

Handling the Charger

- Do not attempt to open the Charger. No user-serviceable parts are inside.
- Charge only Lithium-ion batteries that have been designed for use with the Imager. Do not attempt to recharge other types of rechargeable batteries or any type of primary batteries.
- Do not place objects other than Imager batteries inside the Charger.
- Protect the Charger from excessive heat, cold, moisture, and harsh, dirty environments.
- Do not leave the Charger where moisture will condense on it.

Cleaning the Charger



CAUTION Do not pour, spray, or spill any liquid on the Charger.

The gold plated battery contacts do not tarnish or oxidize. No maintenance should be needed. If the contacts need to be cleaned:

1. Remove power from the Charger.
2. Wet the tip of a cotton swab with isopropyl alcohol and squeeze the excess alcohol from the swab.
3. Wipe the metal contacts with the damp swab.

Chapter 4 RS507 Update and Configuration

Introduction

This chapter covers the following topics:

- Configuring the Imager
- Imager Motion and Proximity Configuration
- Debugging logger
- Firmware upgrade

Configuring the Imager

Introduction

The Imager is a modular product used in several hardware configurations. Such configurations may include corded or cordless connection to a terminal / mobile computer with manual or automatic triggering.

The Imager is provided with a default software configuration set in the factory. This software configuration can be optimized by the customer to meet their specific operational requirements. Therefore, before using the Imager, it is essential that the Imager be properly configured to harness its extensive capabilities and gain maximum efficiency.

There are several ways to configure the Imager. The best way is to set the parameters for each application allowing the required degrees of freedom. In some cases it is recommended to allow the user to select between the various operational modes or use cases, each with its own set of parameters.

Motorola mobile computers using the EMDK may utilize the SCAN and/or RSM APIs to configure the operation of the Imager. Motorola terminals that cannot use the EMDK, may configure some operations of the Imager by scanning special configuration bar codes (see [Miscellaneous Imager Options on page 5-1](#)) as done with many of Motorola bar code scanners.

A selection of most configured Imager parameters can be set with the Remote Scanner Management Sample (RSMSample) application installed on all Motorola mobile computers supporting the Imager. Some of the Imager parameters can also be set by the Control Panel application.

Once connected to a mobile computer, the application running on the mobile computer overrides the Imager parameters previously set.

Control Panel Application

The Control Panel (CTLpanel) application can be used for configuring the Imager by changing its values. The Control Panel application also enables one to retrieve and display the current setting of each value.

The Control Panel application together with the RSMsample application enable the user to configure the RS507. Users with Mobile computer that do not have the Control Panel application installed can download the application (CtlPanelWM.exe) and related documentation from the Support Central site at:

<http://www.motorola.com/enterprisemobility/contactsupport>.

The following example describes how to read and configure new values of the Imager attributes.

To set new attribute values:

1. When using the WT4090, from the *App Launcher* screen, open the *Utilities* folder and start the *Control Panel* application. When using a mobile computer with Windows Mobile, open the *Application* folder and start the *CtlPanelWM* application.

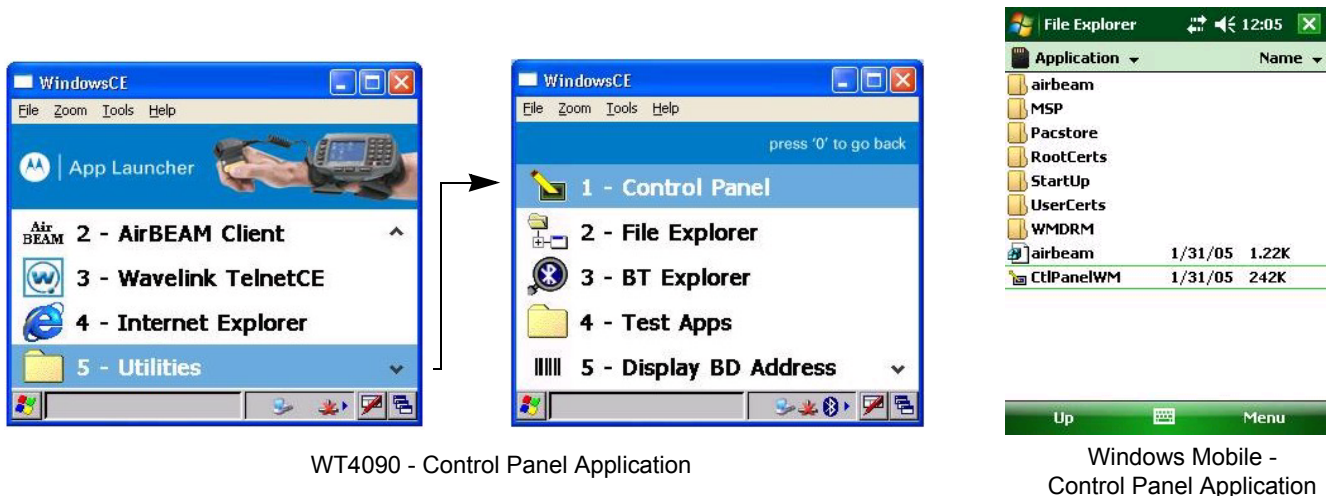

Figure 4-1 Starting the Control Panel Application

2. Select *Scanner Settings*



Figure 4-2 Scanner Settings

- Use the > < keys to select scanner. Select *SCN1* for corded Imager or *SCN2* for cordless Imager (Bluetooth).

✓ **NOTE** Before you select *SCN2* make sure to pair and connect the Imager to the mobile computer.

- Select *Reader Params...*



Figure 4-3 *Reader Params...*

- Use the > < keys to change the *Picklist Mode* to *Enable* and press the OK button.

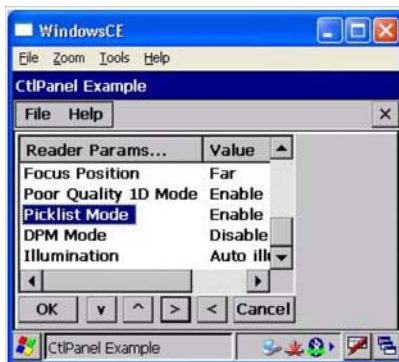

Figure 4-4 *Picklist Mode*

This setting is retained until cold boot is performed to the mobile computer or new setting is entered through the Control Panel application.

- Re-start your scan application and verify that *Picklist Mode* is enabled.

RSMSample Application

The Remote Scanner Management Sample (RSMSample) application is used for configuring the Imager by changing its attribute values. The RSMSample application also enables one to retrieve and display the current setting of each attribute. Users with mobile computer that do not have the RSMSample application installed can download the application and related documentation from the Support Central site at:

<http://www.motorola.com/enterprisemobility/contactsupport>.

✓ **NOTE** When the Imager is connected to a mobile computer, configuration by scanning bar codes is disabled. In such case, the Imager configuration is performed by the application (e.g RSMSamplen) running on the mobile computer. The new configuration overrides the previous configuration. The new configuration is saved in the Imager memory after disconnecting the Imager from the mobile computer or terminating the application.

The following example describes how to read and configure new values of the Imager attributes.

To set new attribute values:

1. From the mobile computer *Application* folder, run the RSMSample application.

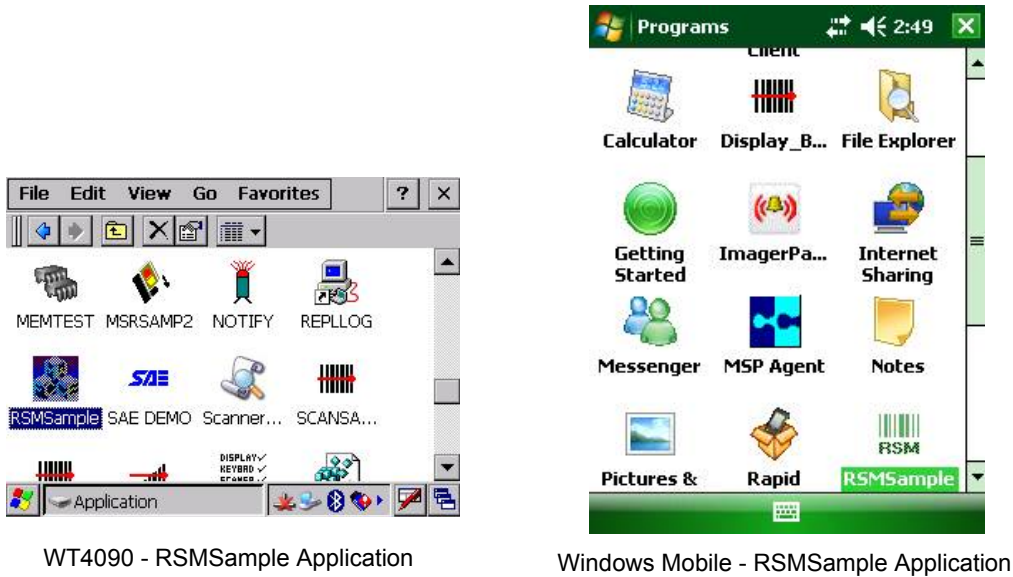

Figure 4-5 Mobile Computer Application Folder - RSMSample Application Icon

2. From the *Dialog* window, select *Bluetooth SSI Scanner Driver*.



Figure 4-6 Dialog Window - Bluetooth SSI Scanner Driver

3. Press the **Get All Supported Attributes** button to display all supported attributes.

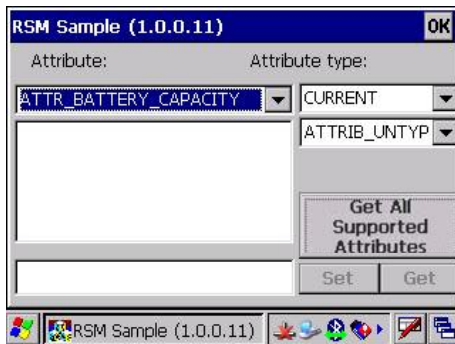

Figure 4-7 RSMSample Application - Get All Supported Attributes Button

4. The Attribute scroll window displays all supported attributes (see [Table 4-1 on page 4-7](#)) and an operation success indication.

Attribute Scroll Window

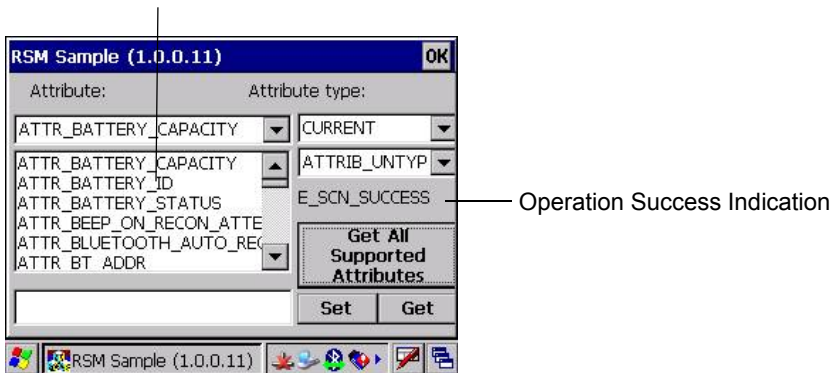

Figure 4-8 RSMSample Application - Attribute Scroll Window

5. Select the attribute you wish to change and press the **Get** button to display the current value of the attribute.

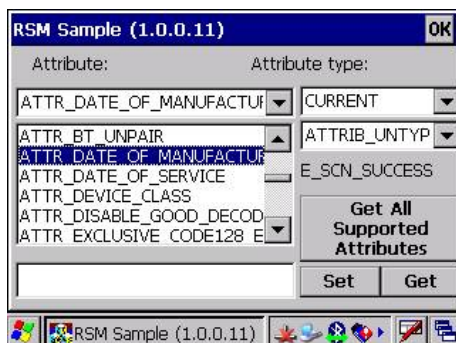

Figure 4-9 RSMSample Application - Get Button

- The application returns the current value settings of the attribute.

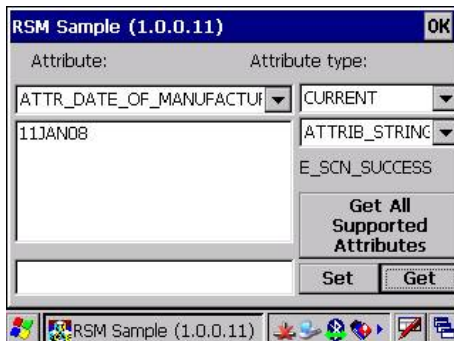
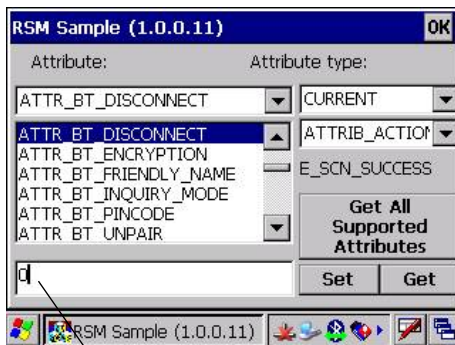

Figure 4-10 RSM Sample Application - Current Value Settings of Attribute

- Press again the **Get All Supported Attributes** button to show all supported attributes (see Figure 4-11).
- Select an attribute (see Table 4-1), enter the new value and press the **Set** button.



Value Line

Figure 4-11 RSM Sample Application - Setting an Attribute

In the following example, after setting the ATTR_BT_DISCONNECT attribute to 0 (disconnect), the Bluetooth radio of the Imager is turned off successfully as indicated by the change of the Bluetooth icon from Bluetooth Connection icon to Bluetooth Disabled icon.

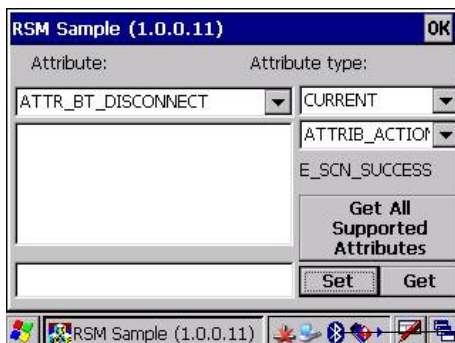

Bluetooth Disabled icon

Figure 4-12 RSM Sample Application - Bluetooth Radio Turned Off Successfully Indication

Imager Attributes

[Table 4-1](#) lists the Imager attributes that can be changed using the RSMSample application.

Table 4-1 lists of Imager Attributes

Attribute	Access	Values	Factory Default	Description
ATTR_SCANLINE_WIDTH	R/W	0 – (Pick list disabled) 2 – Narrow (Pick list enabled)	0	Width of laser scan line or size of Imager's effective Field of View (Pick list)
ATTR_DISABLE_GOOD_DECODE_LED_BEEP	R/W	0- Enabled automatically green LED and beep on good decode. 1- Disabled		Good decode feedback on Imager
ATTR_MODEL_NUMBER	R	N/A	N/A	Model number
ATTR_SERIAL_NUMBER	R	N/A	N/A	Serial number
ATTR_DATE_OF_MANUFACTURE	R	N/A	N/A	Date of manufacture
ATTR_DATE_OF_SERVICE	R	N/A	N/A	Last date of repair by Motorola
ATTR_BT_ADDR	R	N/A	N/A	Imager Bluetooth address
ATTR_BT_AUTHENTICATION	R/W	1 - Enabled 0 - Disabled	1	Enable Bluetooth authentication (Permanently saved)
ATTR_BT_ENCRYPTION	R/W	1 - Enabled 0 - Disabled	1	Enable encryption over Bluetooth (Permanently saved)
ATTR_BT_PINCODE	R/W	Up to six characters	"12345"	Pin code when Bluetooth Authentication is enabled (Permanently saved)
ATTR_RECONNECT_ATTEMPTS	R/W	6 = 30 sec, 7 = 35 sec, 8 = 40 sec, 9 = 45 sec, 10 = 50 sec, 11 = 55 sec, 12 = 60 sec	6	Reconnect attempt duration when the Imager is out of range
ATTR_BEEP_ON_RECON_ATTEMPT	R/W	1 - Enabled 0 - Disabled	0	When enabled, the Imager emits 5 short high beeps every 5 seconds while the reconnection attempt is in progress

Attribute	Access	Values	Factory Default	Description
ATTR_HID_AUTO_RECON	R/W	0 - Never Reconnect 1 - Reconnect on Data 2 - Reconnect immediately	0	Auto-reconnect behavior when connection is lost.
ATTR_BT_FRIENDLY_NAME	R/W	Up to 23 characters	"RS507"	Friendly name displayed by Bluetooth remote devices (Permanently saved).
ATTR_PIN_CODE_TYPE	R/W	1 - User prompt 0 - Automatically use stored PIN code	0	Prompt the user for PIN code or use PIN code stored in memory.
ATTR_BT_INQUIRY_MODE	R/W	1 - Limited 0 - General	0	The used inquiry mode: Limited: The Imager finds only an associated device. General: The Imager finds all the visible devices.
ATTR_EXCLUSIVE_CODE128_EN	R/W	1 - Enabled 0 - Disabled	0	Ignore Code 128 beginning with 420 and 421
ATTR_MEMS_ENABLE	R/W	1 - Enabled 0 - Disabled	Trigger Model -0 Triggerless Model -1	Motion trigger feature
ATTR_PROXIMITY_ENABLE	R/W	1 - Enabled 0 - Disabled	Trigger Model -0 Triggerless Model -1	Proximity feature
ATTR_PROXIMITY_DISTANCE	R/W	0 – Short 1 – Mid 2 – Long	2	Proximity distance
ATTR_PAGING_ENABLE	R/W	1 - Enabled 0 - Disabled	0	Paging device enable / disable
ATTR_PAGING_BEEP_SEQ	R/W	0-26	15	Paging beep sequence Beep pattern values.
ATTR_LOW_BATTERY_IND_EN	R/W	1 - Enabled 0 - Disabled	0	Low battery indication.

Attribute	Access	Values	Factory Default	Description
ATTR_SCAN_TRIG_WAKEUP_EN	R/W	1 - Enabled 0 - Disabled	1	Scan trigger serves as an Imager wake-up source from low power.
ATTR_BLUETOOTH_AUTO_RECON	R/W	0 –None 1 - Power on 2 - On when back in range 3 - On when power is on and back within range	2	Defines Bluetooth reconnection scheme (Permanently saved) Important: If option 1 (On Power) or 3 (On when power is on and back within range) is set, the pair should be properly marked and kept visible on the Imager and mobile computer to avoid user selecting of an unpaired set.
ATTR_PROXIMITY_CONTINUOUS_EN	R/W	1 - Enabled 0 - Disabled	0	Proximity continuous mode (for scanning packages off conveyer belt).
ATTR_GOOD_SCANS_DELAY	R/W	Values 0 -150 (in 100 msec intervals) 0 – No delay 1 – 150 (100 – 15000 msec)	0	Delay between good scans in proximity continuous mode (msec).
ATTR_FORCE_PAIRING_SAVE	R/W	0 – Disabled 1 – Enabled	1	Force BD_Address saving when pairing fails (Permanently saved).
ATTR_PAGING_ACTIVATE	W	0 – Stop 1 – Start		Start / stop Imager paging
ATTR_BT_DISCONNECT	W	0 - Disconnected		Bluetooth disconnect command from terminal to Imager
ATTR_BT_UNPAIR	W	0 - Unpaired		Bluetooth un-pair command from terminal to Imager.
ATTR_FIRM_VERSION	R	N/A		Imager Firmware version.
ATTR_DEVICE_CLASS	R	N/A		Imager system class

Attribute	Access	Values	Factory Default	Description
ATTR_BATTERY_STATUS	R	0- Unknown 1- Full 2- Medium 3- Empty 4- Charging – full rate 5- Charging – half rate 6- Charging – Trickle 7- Discharging – Battery Cycle in progress		Battery Status
ATTR_BATTERY_CAPACITY	R	0-100 (battery percent) 9999 if error (no battery)		Battery capacity
ATTR_BATTERY_ID	R	0 – Simple 1 – Double 2 – Cabled 9999 – Error		Battery ID

Imager Motion and Proximity Configuration

The Imager proximity and motion feature enables auto-triggering of the Imager upon motion and/or proximity to an object.

Motion and proximity detection can be enabled or disabled by the mobile computer application such as the Remote Scanner Management (RSMSample) application of the mobile computer (see [“RSMSample Application” on page 4-3](#)) or by scanning configuration bar codes (see [Miscellaneous Imager Options on page 5-1](#)).

✓ **NOTE** Once configured, the motion and/or proximity attributes are retained in the Imager memory following warm or cold boot.

Operation Modes

The Imager can be configured to a single or continuous scan operation. In most use cases, a single scan mode is the preferred operation. However, when scanning packages off a moving conveyer belt, it is sometimes recommended to use the continuous scan mode (also referred to as 'Proximity Continuous' mode). Continuous operation automatically results from the combined settings of motion and proximity (enabling or disabling motion and/or proximity. See [Table 4-2](#)). The Imager is provided with motion and proximity enabled by default. To set new values to the motion and/or proximity attributes, refer to [Imager Attributes on page 4-7](#).

Table 4-2 Imager Operation Modes

Mode Number	Parameter States (Motion / Proximity / Continuous Scan)	Description
1	Motion: enabled Proximity: enabled Continuous scan: disabled	The Imager performs a single scan when moved and positioned in proximity to an object. Scanning resumes when the Imager is moved and re-positioned in proximity to an object. This mode is a default mode.
2	Motion: disabled Proximity: enabled Continuous scan: disabled	The Imager starts to continuously scan when positioned in proximity to an object. The Imager stops scanning when the object is out of proximity range.
3	Motion: enabled Proximity: disabled Continuous scan: disabled	Upon movement, the Imager performs a single scan and stops.
4	Motion: enabled Proximity: enabled Continuous scan: enabled	The Imager performs a continuous scan when moved and positioned in proximity to an object. The Imager continues to scan as long as it detects an object within its range and bar codes are scanned successfully. The Imager stops scanning if proximity to an object is not detected, or if the Imager fails to scan three consecutive times.
5	Motion: disabled Proximity: enabled Continuous scan: enabled	The description of this operation mode is identical to the description of mode number 2 in this table.

Configuring Motion and Proximity by Scanning Bar Codes

- ✓ **NOTE** Scanning bar codes for configuring motion and/or proximity is enabled only when the Imager is in cordless (Bluetooth) configuration.

To enable or disable motion or proximity, perform cold boot by removing and re-installing the battery (see [Remove the Battery on page 1-6](#)).

- ✓ **NOTE** Throughout this section, configuration bar codes shown with asterisks (*) indicate default values.

Motion Sensing Control

Disable Motion Trigger



*Enable Motion Trigger



Proximity Sensing Control

Disable Proximity



*Enable Proximity



Proximity Continuous Enable

The Proximity Continuous Enable parameter enables/disables the proximity continuous feature.

*Disable Proximity Continues



Enable Proximity Continues



The Proximity Distance parameter sets the proximity sensitivity range.

Short Range



Mid Range



*Long Range



Good Scan indication delay Control

The Good Scan Delay parameter sets a delay between good scans when scanning is in continuous mode.

This delay is effective when:

- Motion detection - Enabled
- Proximity - Enabled
- Proximity continues - Enabled

Or

- Motion detection - Disabled
- Proximity - Enabled

0 msec



200 msec



400 msec



800 msec



1200 msec



1600 msec



2000 msec



*600 msec



1000 msec



1400 msec



1800 msec



Real Time Logger

The Imager includes a Real Time Logger application that logs events, errors, exceptions and software diagnostics of the Imager during its operation. Each log record has a time stamp with a 1ms resolution. The logger time is synchronized with the host computer's time. The log is retained only after warm boot. The log memory size is 4 MB and operates in a cyclic way.

Figure 4-13 shows the Real Time Logger file content as shown on a host computer screen.

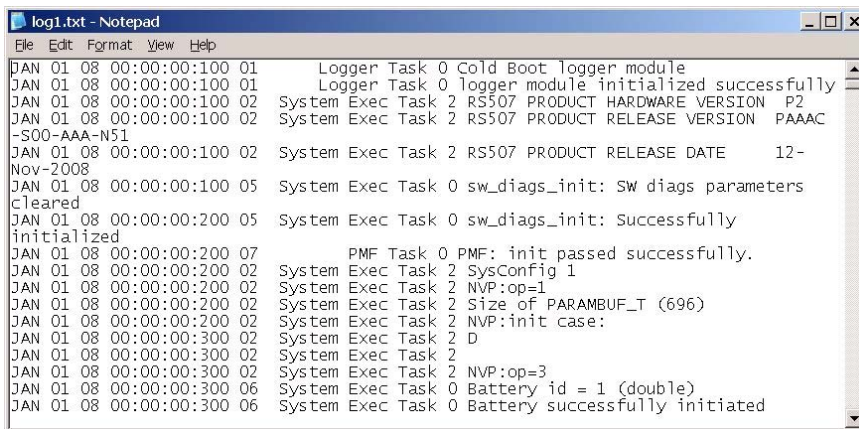

```

log1.txt - Notepad
File Edit Format View Help
JAN 01 08 00:00:00:100 01      Logger Task 0 Cold Boot logger module
JAN 01 08 00:00:00:100 01      Logger Task 0 logger module initialized successfully
JAN 01 08 00:00:00:100 02      System Exec Task 2 RS507 PRODUCT HARDWARE VERSION P2
JAN 01 08 00:00:00:100 02      System Exec Task 2 RS507 PRODUCT RELEASE VERSION PAAAC
-S00-AAA-N51
JAN 01 08 00:00:00:100 02      System Exec Task 2 RS507 PRODUCT RELEASE DATE 12-
Nov-2008
JAN 01 08 00:00:00:100 05      System Exec Task 0 sw_diags_init: SW diags parameters
cleared
JAN 01 08 00:00:00:200 05      System Exec Task 0 sw_diags_init: Successfully
initialized
JAN 01 08 00:00:00:200 07      PMF Task 0 PMF: init passed successfully.
JAN 01 08 00:00:00:200 02      System Exec Task 2 SysConfig 1
JAN 01 08 00:00:00:200 02      System Exec Task 2 NVP:op=1
JAN 01 08 00:00:00:200 02      System Exec Task 2 Size of PARAMBUF_T (696)
JAN 01 08 00:00:00:200 02      System Exec Task 2 NVP:init case:
JAN 01 08 00:00:00:300 02      System Exec Task 2 D
JAN 01 08 00:00:00:300 02      System Exec Task 2
JAN 01 08 00:00:00:300 02      System Exec Task 2 NVP:op=3
JAN 01 08 00:00:00:300 06      System Exec Task 0 Battery id = 1 (double)
JAN 01 08 00:00:00:300 06      System Exec Task 0 Battery successfully initiated

```

Figure 4-13 Real Time Logger Content Screen

ScannerLog Application

✓ **NOTE** When ScannerLog Application is used with a corded connection. Open the ScannerLog application while the scan application is still running.

1. Perform a warm boot (see [Warm Boot on page 1-17](#))
2. Select the Imager ScannerLog Task application from the *Application* folder.



ScannerLog Application icon on WT4090 screen



ScannerLog Application icon on Windows Mobile screen

Figure 4-14 ScannerLog Application Icon

- From the *Dialog* screen, Select *Bluetooth SSI Scanner Driver* and press the **OK** button.



Figure 4-15 *Dialog Screen - Bluetooth SSI Scanner Driver*

- Define the name and download location of the log file and press the **OK** button.

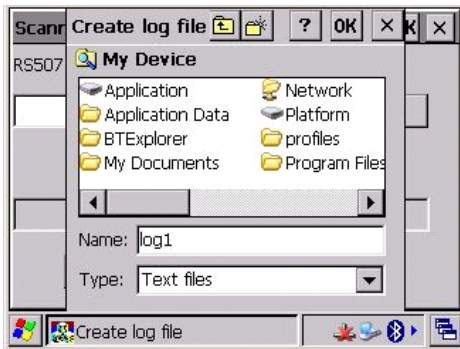

Figure 4-16 *ScannerLog Application - Log File Name and Download Location*

- Press **Start** to begin downloading.

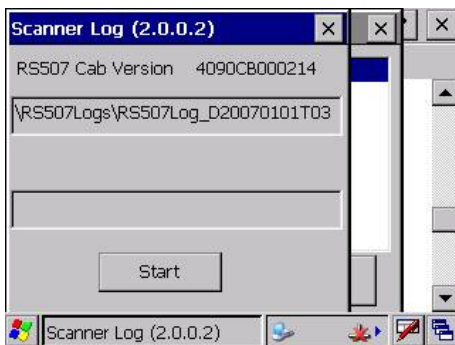

Figure 4-17 *ScannerLog Application- Starting Download*

- Verify that downloading of the log file starts.

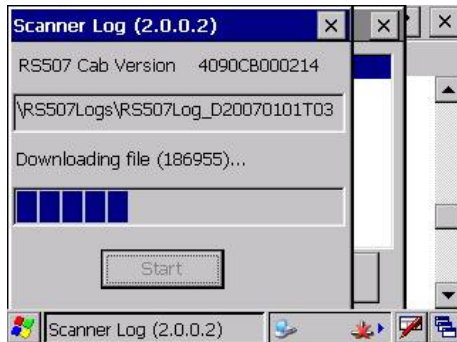

Figure 4-18 ScannerLog Application- Download in Progress

- Verify that the log file download is completed and press the **OK** button.

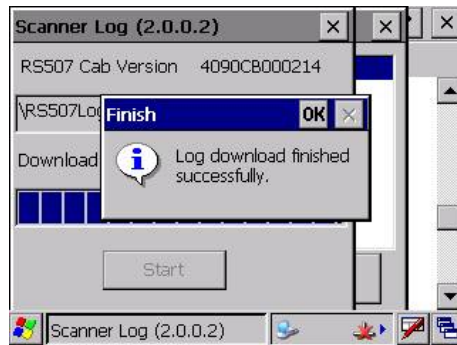

Figure 4-19 ScannerLog Application- Download Completed

- On the mobile computer, open the log file to see the content.

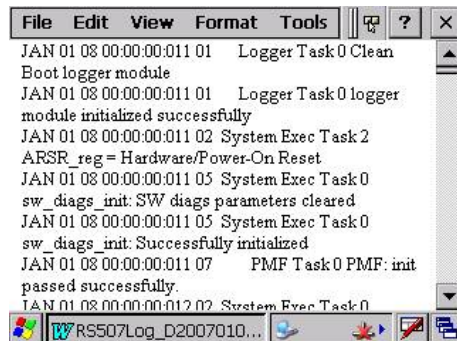

Figure 4-20 ScannerLog Application - Log File Content

Imager Firmware Update

Required Equipment

The following hardware is required for updating the firmware of the Imager:

- Host computer
- Mobile computer
- USB / RS232 interface cable or any cradle set-up used for establishing an ActiveSync connection between the host computer and mobile computer.

The following software is required for updating the firmware of the Imager:

- New Imager firmware file (*.DAT file format)
- CAB file to install in the mobile computer.
- ActiveSync application installed on the host computer and the mobile computer (for copying the new Imager firmware and RS507 CAB files from the host computer to the mobile computer).
- FirmwareUpdate application installed in the mobile computer (part of the CAB file installation). This application is used for downloading the firmware file from the mobile computer to the Imager.

Updating the RS507 Firmware

Before using the FirmwareUpdate application:

1. Exit all scanning applications running on the mobile computer.
2. Verify that the mobile computer battery is fully charged or that the mobile computer is connected to an external power source.
3. When using a corded Imager, verify that the Imager is properly connected to the mobile computer. When using a cordless Imager verify that the Imager battery is fully charged.

To upgrade the Imager firmware:

1. Connect the Imager to the mobile computer that supports the RS507.
2. Start the FirmwareUpdate application located in the Application folder for WinCE devices or under Start / Programs for Windows Mobile devices (the FirmwareUpdate application and related documentation can be downloaded from the Support Central site at: <http://www.motorola.com/enterprisemobility/contactsupport>).

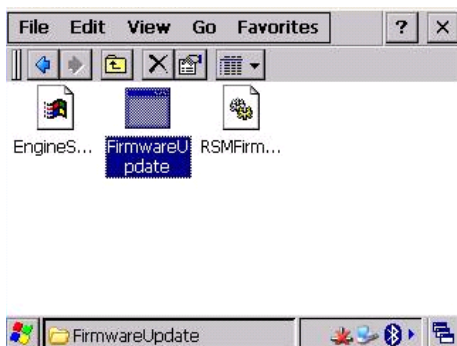

Figure 4-21 FirmwareUpdate Application Icon

3. Select the interface method (Bluetooth in the following example).

✓ **NOTE** The following screen is displayed only when using the WT4090. In other mobile computers, Bluetooth mode is selected by default. Press **Yes** (Bluetooth mode) to pair the Imager with the mobile computer (see [Restore Lost Bluetooth Connection on page 1-12](#)).

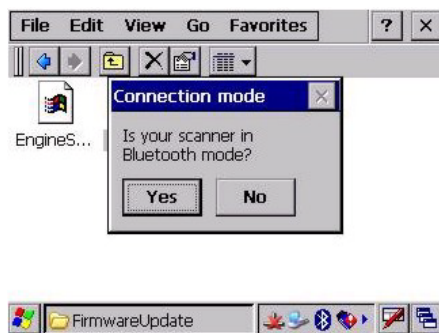

Figure 4-22 Selection of the Bluetooth Interface Mode

4. Press the **Firmware** button and verify that the application shows the version number of the current firmware of the Imager.

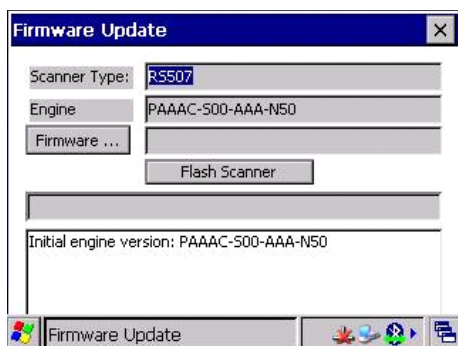

Figure 4-23 Firmware Update Screen

5. Copy the *.DAT file to the mobile computer using ActiveSync connection.
6. Press the **Firmware...** button to select the new firmware *.DAT file and the **OK** button.



Figure 4-24 Firmware Update Screen - Selection of *.DAT File

- Press the **Flash Scanner** button to start updating the firmware.

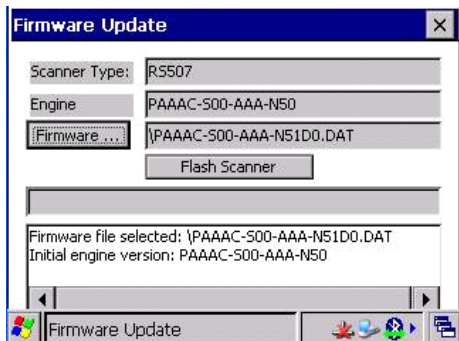

Figure 4-25 Firmware Update Screen - Flash Scanner Button

- Verify that the firmware download starts. When the download starts, the **### Starting Firmware Download!** message displays. Firmware download is completed when the *Update engine version...* message is displayed.



Figure 4-26 Firmware Update Screen - "Starting Firmware Download!" Message

- Pair the Imager with the mobile computer (see [Restore Lost Bluetooth Connection on page 1-12](#)).
- Verify that the firmware download is completed by looking at the Initial software version number and the new software version number.

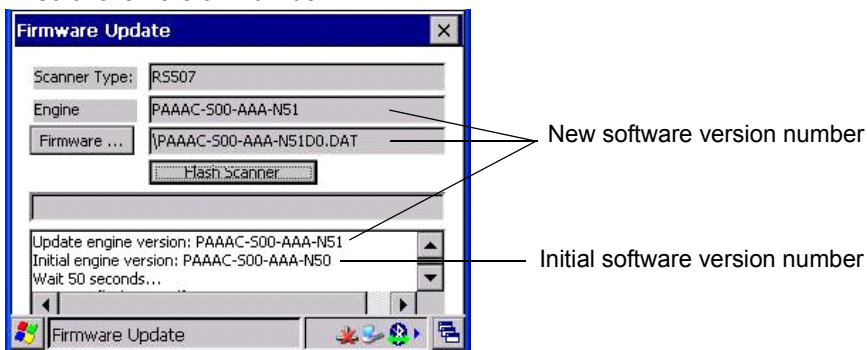

Figure 4-27 Firmware Update Screen

- Press the **Esc** key on the mobile computer or the X in the top right corner of the application window to exit the FirmwareUpdate application.

Rapid Deployment Client

The Rapid Deployment (RD) Client application downloads an AirBeam package to a mobile computer connected to an Imager from a Mobility Services Platform (MSP) Console's FTP server.

The MSP Console is a web-based interface to the wireless infrastructure monitoring and management tools provided by the MSP Lite or MSP Enterprise server.

AirBeam packages transferred to the FTP server, are downloaded to mobile computers connected to the wireless network. The location of AirBeam packages are encoded in deployment bar codes. When an Imager captures a deployment bar code, the AirBeam package(s) is downloaded from the FTP server to the Imager via the mobile computer. A single deployment bar code can be captured by many Imagers.

✓ **NOTE** For detailed information about the MSP Console, MSP Lite/MSP Enterprise servers and creating deployment bar codes, refer to the MSP User Guide.

The AirBeam package can be downloaded from the Support Central web site ([Service Information on page xv](#)). The package includes:

- Mobile computer's RS507 enhancement .APF file
- Compatible RS507 Firmware .APF file.

The .APF file is used for management and distribution of the AirBeam package when the file is transferred from the MSP to the Imager connected to the mobile computer over the Bluetooth.

✓ **NOTE** Make sure that the enhancement APF file is deployed on the mobile computer before you start the deployment.

To download the AirBeam package from the remote MSP server:

1. Install the RS507_xxx.APF file on the MSP server (refer to MSP server documentation).
2. Connect the mobile computer to the network via WLAN, or other cradle or cable connection (refer to you mobile computer user guide).

- From the App Launcher (or Windows Mobile Programs) screen of your mobile computer, start the Rapid Deployment Client application.



Rapid Deployment Client Application Icon on WT4090 Screen



Rapid Deployment Client Application Icon on Windows Mobile Screen

Figure 4-28 Rapid Deployment Client Application Icon

- The Rapid Deployment Client Application searches for Imagers. Press the **Pair** button displayed on the screen.

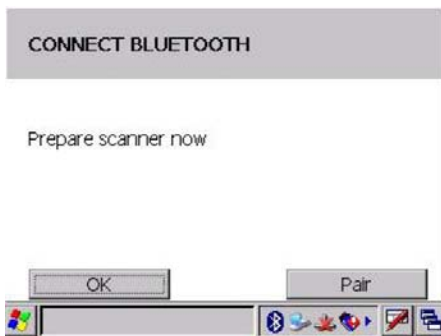

Figure 4-29 Rapid Deployment Client Application - Bluetooth Connection Screen

- The Display BD Address utility is displayed. Use the Imager to scan the pairing bar code from the mobile computer screen and press the **ESC** button on the mobile computer.



Figure 4-30 Display BD Address Utility - Pairing Bar Code

6. The *Scan bar code to deploy* screen is displayed. Scan the deployment bar code provided by your system administration to start the update process.

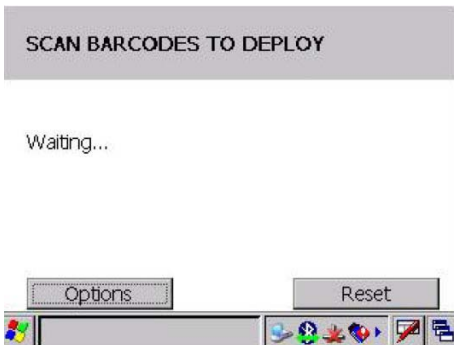

Figure 4-31 *Scan Bar Code to Deploy Screen*

During the update, process reports are display on the screen and the Imager LEDs show the following indications:

- Flashing red - firmware file is downloading
- Steady red - firmware file is extracted inside the Imager
- Steady Green and a single beep - firmware update is completed

Chapter 5 Miscellaneous Imager Options

Introduction

The Imager is intended to operate hand in hand with the mobile computer to which it is connected.

The mobile computer automatically loads configuration data whenever connected to an Imager (corded or cordless). This operation does not require scanning configuration bar codes. Using configuration bar codes is only available for a cordless Imager when decontrolled from the mobile computer.

It is recommended to use configuration bar codes only for setting parameters that cannot be configured by the other mobile computer application.

✓ **NOTE** Imager parameters set by scanning configuration bar codes, persist in the Imagers memory.

The Imager ships with the settings shown in [Table 5-1 on page 5-2](#) (also see [Appendix A, Standard Default Parameters](#) for host device and miscellaneous defaults). If the default values suit the requirements, programming is not necessary.

✓ **NOTE** Most computer monitors allow scanning the bar codes directly on the screen (when using the imaging engine). When scanning from the screen, be sure to set the document magnification to a level where you can see the bar code clearly, and bars and/or spaces are not merging.

To return all features to default values, scan the [Set Default Parameter on page 5-4](#). Throughout the programming bar code menus, asterisks indicate (*) default values.



* Indicates Default — *High Volume — Feature/Option
(00h) — Option Hex Value for programming via SSI command

Scanning Sequence Examples

In most cases, scanning one bar code sets the parameter value. For example, to set the beeper tone to high, scan the **High Frequency** (beeper tone) bar code listed under [Beeper Tone on page 5-6](#). The Imager issues a fast warble beep and the LED turns green, signifying a successful parameter entry.

Other parameters, such as **Serial Response Time-Out** or **Data Transmission Formats**, require scanning several bar codes. See these parameter descriptions for this procedure.

Errors While Scanning

Unless otherwise specified, to correct an error during a scanning sequence, just re-scan the correct parameter.

User Preferences/Miscellaneous Options Parameter Defaults

[Table 5-1](#) lists defaults for user preferences parameters.

Scan the appropriate bar codes in this guide. These new values replace the standard default values in memory. To recall the default parameter values, scan the [Set Default Parameter on page 5-4](#).

✓ **NOTE** See [Appendix A, Standard Default Parameters](#) for all user preferences, hosts, symbologies, and miscellaneous default parameters.

Table 5-1 User Preferences Parameter Defaults

Parameter	Parameter Number	Default	Page Number
User Preferences			
Motion Sensing Control		Enabled	4-12
Proximity Sensing Control		Enabled	4-12
Proximity Continuous		Enabled	4-12
Proximity Continuous Enable		Disabled	4-12
Good Scan indication delay Control		600 ms	4-13
Set Default Parameter		Set Defaults	5-4
Parameter Bar Code Scanning	ECh	Enabled	5-5
Beep After Good Decode	38h	Enabled	5-5
Beeper Tone	91h	Medium	5-6
Beeper Volume	8Ch	High	5-7
Beeper Duration	F1 74h	Medium	5-8
Picklist Mode	F0h 92h	Disabled Always	5-10

Table 5-1 *User Preferences Parameter Defaults (Continued)*

Parameter	Parameter Number	Default	Page Number
Fuzzy 1D Processing	F1h 02h	Enabled	5-11
Decoding Illumination	F0h, 2Ah	Enabled	5-12
Miscellaneous Options			
Transmit Code ID Character	2Dh	None	5-16
Prefix Value	63h, 69h	7013 <CR><LF>	5-17
Suffix 1 Value Suffix 2 Value	62h 68h 64h 6Ah	7013 <CR><LF>	5-17
Scan Data Transmission Format	EBh	Data as is	5-18
FN1 Substitution Values	67h 6Dh	Set	5-19
Transmit "No Read" Message	5Eh	Disabled	5-20
Bluetooth Pairing Bar Code		None	1-12
Bluetooth Un-pairing Bar Code		None	1-13

User Preferences

Set Default Parameter

You can reset the Imager to two types of defaults: factory defaults or custom defaults. Scan the appropriate bar code below to reset the decoder to its default settings and/or set its current settings as custom defaults.

- **Set Defaults** - Scan this bar code to reset all parameters to custom default settings.
- **Set Factory Defaults** - Scan this bar code to restore the factory default values listed in [Table A-1](#). This deletes any custom defaults set.



***Set Defaults**



Set Factory Defaults

Parameter Bar Code Scanning

Parameter # ECh

To disable the decoding of parameter bar codes, including the **Set Defaults** parameter bar codes, scan the **Disable Parameter Scanning** bar code below. To enable decoding of parameter bar codes, scan **Enable Parameter Scanning**.



*Enable Parameter Bar Code Scanning
(01h)



Disable Parameter Bar Code Scanning
(00h)

Beep After Good Decode

Parameter # 38h

Scan a bar code below to select whether or not the Imager beeps after a good decode. If selecting **Do Not Beep After Good Decode**, the beeper still operates during parameter menu scanning and to indicate error conditions.



*Beep After Good Decode
(Enable)
(01h)



Do Not Beep After Good Decode
(Disable)
(00h)

Beeper Tone

Parameter # 91h

To select a decode beep frequency (tone), scan one of the following bar codes.



Off
(03h)



Low Tone
(02h)

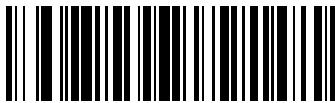

*Medium Tone
(01h)

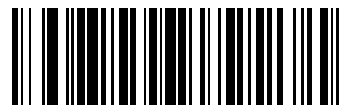

High Tone
(00h)



Medium to High Tone (2-tone)
(04h)

Beeper Volume

Parameter # 8Ch

To select a beeper volume, scan the **Low Volume**, **Medium Volume**, or **High Volume** bar code.



Low Volume
(02h)



Medium Volume
(01h)



***High Volume**
(00h)

Beeper Duration

Parameter # F1 74h

To select the duration for the beeper, scan one of the following bar codes.

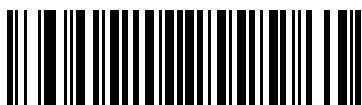

**Short
(00h)**



*** Medium
(01h)**

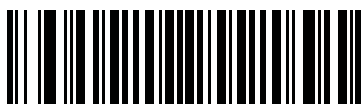

**Long
(02h)**

Imager Activity Modes

The Imager is capable of four modes of activity:

- **Busy (Run) Mode** – The Imager is scanning or transferring data using Bluetooth.
- **Standby Mode** – The Imager enters Standby mode (Low Power Mode) when it is idle for more than one second. The Imager wakes-up and returns to busy (run) mode upon at least one of the following events:
 - Scan trigger
 - Motion activity
 - Bluetooth activity
 - Press of the Restore key
 - Real time clock (a system inside the Imager)
- **Deep Sleep (Critical Off) Mode** – The deep sleep mode is only applicable when the Imager is connected to a mobile computer in cordless mode. When the battery power of the Imager is below 3V, the Imager turns off and enters Standby mode. To recover from Deep Sleep mode, replace the battery with a charged battery (See [“Remove the Battery” on page 6.](#))
- **OFF Mode** – The Imager is not connected to power source.

Picklist Mode

Parameter # F0h 92h

Picklist mode enables the Imager to decode only bar codes that are aligned under the laser crosshair. Select one of the following picklist modes for the Imager:

- **Disabled Always** - Picklist mode is always disabled.
- **Enabled Always** - Picklist mode is always enabled.

✓ **NOTE** For the DS9808-LR, if you configure Trigger B for Imager Decoding and enable Picklist Mode, activating Trigger B turns on the imager aiming pattern, and releasing the trigger activates decoding.



***Disabled Always
(00h)**



**Enabled Always
(02h)**

Fuzzy 1D Processing

Parameter # F1h 02h

This option is enabled by default to optimize decode performance on 1D bar codes, including damaged and poor quality symbols. Disable this only if you experience time delays when decoding 2D bar codes, or in detecting a no decode.



***Enable Fuzzy 1D Processing
(01h)**



**Disable Fuzzy 1D Processing
(00h)**

Decoding Illumination

Parameter # F0h, 2Ah

Selecting **Enable Decoding Illumination** causes the Imager to flash illumination to aid decoding. Select **Disable Decoding Illumination** to prevent the Imager from using decoding illumination.

Enabling illumination usually results in superior images. The effectiveness of the illumination decreases as the distance to the target increases.



*Enable Decoding Illumination
(01h)



Disable Decoding Illumination
(00h)

Low Battery Indication Cycle

The Low Battery Indication Cycle parameter sets low battery indication recurrence.

*Every 10 seconds



Every 20 seconds



Every 30 seconds



Every 40 seconds



Every 50 seconds



Bluetooth Disconnection Alert Control

BT Disconnect Indication

When this parameter is enabled, the RS507 plays a beep every 10 sec when the RS507 BT is disconnected.

*Disable



Enable



Bluetooth Disconnect Indication After Battery Insert

Time delay for BT disconnect indication after battery installed.

60 Seconds



*120 Seconds



180 seconds



240 Seconds



300 Seconds



Bluetooth Disconnect Indication After Bluetooth Disconnection

Time delay for BT disconnect indication after BT disconnection.

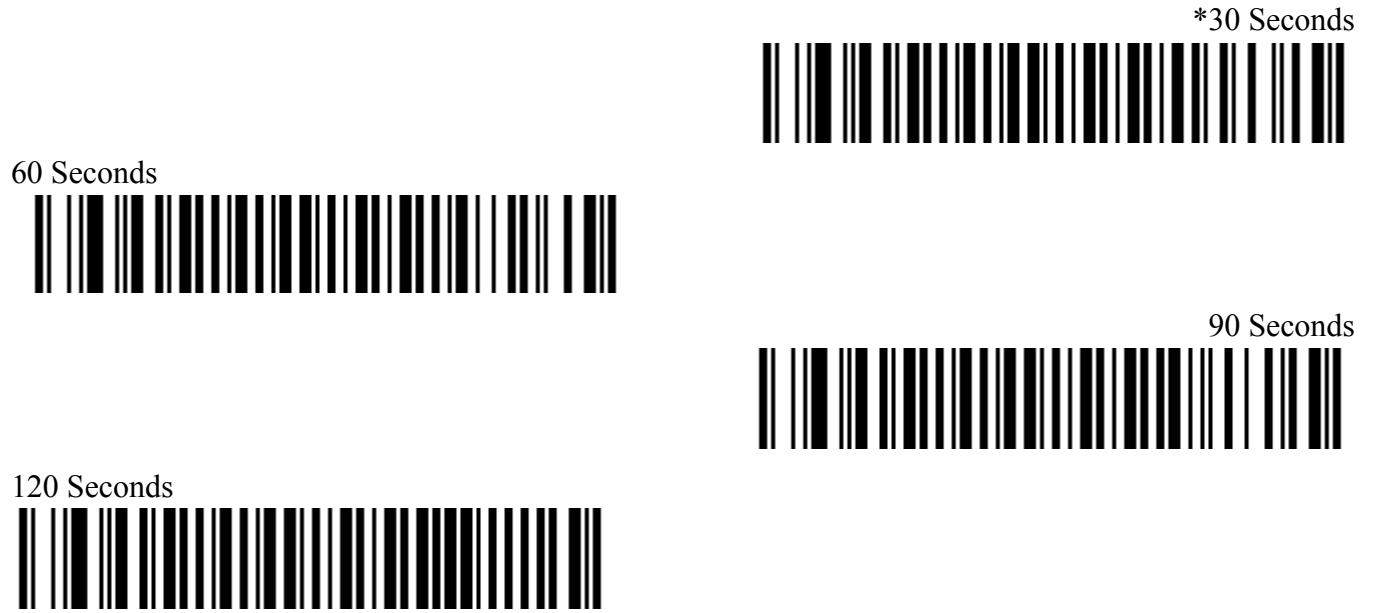

Bluetooth Disconnect Indication - Beep Duration

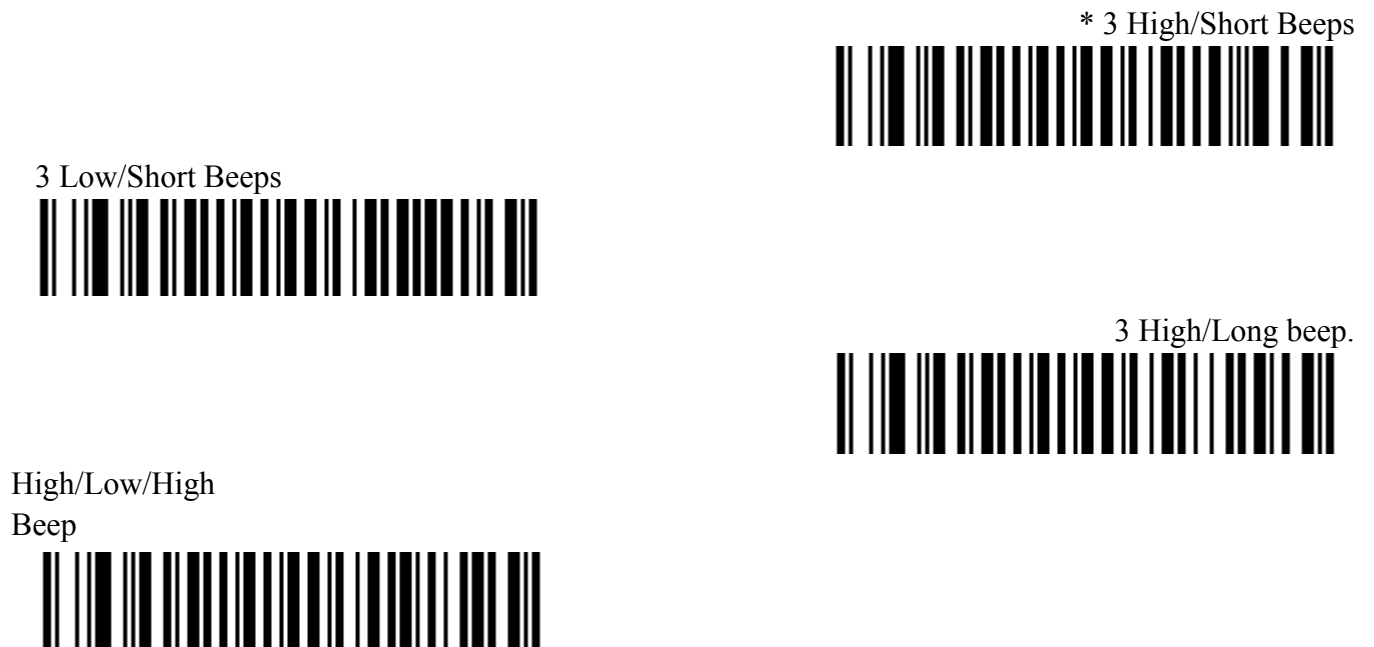

Bluetooth Disconnect Indication - LED Indication

Green LED turns on for 600ms



Green LED turns on for 1000ms



Red LED turns on for 600ms



*Red LED turns on for
600ms



Miscellaneous Scanner Parameters

Transmit Code ID Character

Parameter # 2Dh

A Code ID character identifies the code type of a scanned bar code. This is useful when decoding more than one code type. In addition to any single character prefix already selected, the Code ID character is inserted between the prefix and the decoded symbol.

Select no Code ID character, a Symbol Code ID character, or an AIM Code ID character. For Code ID Characters, see [Symbol Code Identifiers on page B-1](#) and [AIM Code Identifiers on page B-3](#).

✓ **NOTE** If you enable Symbol Code ID Character or AIM Code ID Character, and enable [Transmit "No Read" Message on page 5-20](#), the Imager appends the code ID for Code 39 to the NR message.

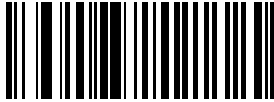

Symbol Code ID Character
(02h)



AIM Code ID Character
(01h)

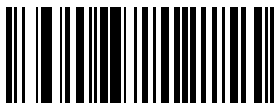

*None
(00h)

Prefix/Suffix Values

Key Category Parameter # P = 63h, S1 = 62h, S2 = 64h

Decimal Value Parameter # P = 69h, S1 = 68h, S2 = 6Ah

You can append a prefix and/or one or two suffixes to scan data for use in data editing. To set a value for a prefix or suffix, scan a four-digit number (i.e., four bar codes from [Appendix D, Numeric Bar Codes](#)) that corresponds to that value.

When using host commands to set the prefix or suffix, set the key category parameter to 1, then set the 3-digit decimal value.

To correct an error or change a selection, scan [Cancel on page D-2](#).

✓ **NOTE** To use Prefix/Suffix values, first set the [Scan Data Transmission Format on page 5-18](#).



Scan Prefix
(07h)



Scan Suffix 1
(06h)



Scan Suffix 2
(08h)



Data Format Cancel

Scan Data Transmission Format

Parameter # EBh

To change the scan data format, scan one of the following eight bar codes corresponding to the desired format.

✓ **NOTE** If using this parameter do not use ADF rules to set the prefix/suffix.

To set values for the prefix and/or suffix, see [Prefix/Suffix Values on page 5-17](#).



*Data As Is
(00h)



<DATA> <SUFFIX 1>
(01h)



<DATA> <SUFFIX 2>
(02h)



<DATA> <SUFFIX 1> <SUFFIX 2>
(03h)



<PREFIX> <DATA >
(04h)

Scan Data Transmission Format (continued)

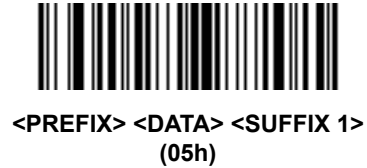

FN1 Substitution Values

Key Category Parameter # 67h

Decimal Value Parameter # 6Dh

The Wedge and USB HID Keyboard hosts support a FN1 Substitution feature. Enabling this substitutes any FN1 character (0x1b) in an EAN128 bar code with a value. This value defaults to 7013 (Enter Key).

When using host commands to set the FN1 substitution value, set the key category parameter to 1, then set the 3-digit keystroke value. See the ASCII Character Set table for the current host interface for the desired value.

To select a FN1 substitution value via bar code menus:

1. Scan the bar code below.

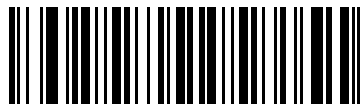

Set FN1 Substitution Value

2. Locate the keystroke desired for FN1 Substitution in the ASCII Character Set table for the current host interface. Enter the 4-digit ASCII Value by scanning each digit in [Appendix D, Numeric Bar Codes](#).

To correct an error or change the selection, scan **Cancel**.

To enable FN1 substitution for USB HID keyboard, scan the **Enable FN1 Substitution** bar code on page [5-19](#).

Transmit “No Read” Message

Parameter # 5Eh

Scan a bar code below to select whether or not to transmit a No Read message. Enable this to transmit the characters NR when a bar code does not decoded. Disable this to send nothing to the host if a symbol does not decode.



NOTE If you enable **Transmit No Read**, and also enable Symbol Code ID Character or AIM Code ID Character for [Transmit Code ID Character on page 5-16](#), the Imager appends the code ID for Code 39 to the NR message.



**Enable No Read
(01h)**



***Disable No Read
(00h)**

Chapter 6 Symbologies

Introduction

This chapter describes symbology features and provides programming bar codes for selecting these features. Before programming, follow the instructions in [Chapter 1, Getting Started](#).

- ✓ **NOTE** When the Imager is connected to a mobile computer, configuration by scanning bar codes is disabled. In such case, programming the Imager is performed by an application running on the mobile computer.

When the Imager is connected to a mobile computer, the configuration application running on the mobile computer may override the parameters previously entered by scanning. Once configured, the new parameters are saved in the Imager memory after disconnecting the Imager or terminating the application.

To set feature values, scan a single bar code or a short bar code sequence. The settings are stored in non-volatile memory and are preserved even when the Imager powers down.

Select a host type after the power-up beeps sound. This is only necessary upon the first power-up when connected to a new host.

To return all features to default values, scan the default bar code (see [Set Default Parameter on page 5-4](#)). Throughout the programming bar code menus, asterisks (*) indicate default values.

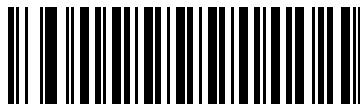

* Indicates Default — *Enable UPC-A — Feature/Option
(01h) — Option Hex Value for programming via SSI command

Scanning Sequence Examples

In most cases, scanning one bar code sets the parameter value. For example, to transmit bar code data without the UPC-A check digit, simply scan the **Do Not Transmit UPC-A Check Digit** bar code under [Transmit UPC-A Check Digit on page 6-14](#). The Imager issues a fast warble beep and the LEDs turn green, signifying a successful parameter entry.

Other parameters, such as **Set Length(s) for D 2 of 5** require scanning several bar codes. See the individual parameter, such as **Set Length(s) for D 2 of 5**, for this procedure.

Errors While Scanning

Unless otherwise specified, to correct an error during a scanning sequence, just re-scan the correct parameter.

Symbology Parameter Defaults

[Table 6-1](#) lists the defaults for all symbology parameters. There are two ways to change the default values:

- Scan the appropriate bar codes in this guide. These new values replace the standard default values in memory. To recall the default parameter values, scan the [Set Default Parameter on page 5-4](#).
- Download data through the device's serial port using SSI. Hexadecimal parameter numbers appear in this chapter below the parameter title, and options appear in parenthesis beneath the accompanying bar codes. Refer to the *Simple Serial Interface (SSI) Programmer's Guide* for detailed instructions for changing parameters using this method.

✓ **NOTE** See [Appendix A, Standard Default Parameters](#) for all user preferences, hosts, and miscellaneous default parameters.

Table 6-1 *Parameter Defaults*

Parameter	Parameter Number	Default	Page Number
UPC/EAN			
UPC-A	01h	Enabled	6-7
UPC-E	02h	Enabled	6-7
UPC-E1	0Ch	Disabled	6-8
EAN-8/JAN 8	04h	Enabled	6-8
EAN-13/JAN 13	03h	Enabled	6-9
Bookland EAN	53h	Disabled	6-9
Decode UPC/EAN/JAN Supplementals (2 and 5 digits)	10h	Ignore	6-11
User-Programmable Supplementals			6-13
Supplemental 1:	F1h 43h		
Supplemental 2:	F1h 44h		
UPC/EAN/JAN Supplemental Redundancy	50h	10	6-13
Decode UPC/EAN/JAN Supplemental AIM ID	F1h A0h	Combined	6-14
Transmit UPC-A Check Digit	28h	Enabled	6-14
Transmit UPC-E Check Digit	29h	Enabled	6-14

Table 6-1 *Parameter Defaults (Continued)*

Parameter	Parameter Number	Default	Page Number
Transmit UPC-E1 Check Digit	2Ah	Enabled	6-15
UPC-A Preamble	22h	System Character	6-16
UPC-E Preamble	23h	System Character	6-16
UPC-E1 Preamble	24h	System Character	6-18
Convert UPC-E to A	25h	Disabled	6-19
Convert UPC-E1 to A	26h	Disabled	6-19
EAN-8/JAN-8 Extend	27h	Disabled	6-20
Bookland ISBN Format	F1h 40h	ISBN-10	6-21
UCC Coupon Extended Code	55h	Enabled	6-22
ISSN EAN	F1h 69h	Disabled	6-22
Code 128			
Code 128	08h	Enabled	6-23
Set Length(s) for Code 128	D1h D2h	Any Length	6-23
GS1-128 (formerly UCC/EAN-128)	0Eh	Enabled	6-24
ISBT 128	54h	Enabled	6-25
ISBT Concatenation	F1h 41h	Disabled	6-26
Check ISBT Table	F1h 42h	Enabled	6-27
ISBT Concatenation Redundancy	DFh	10	6-27
Code 39			
Code 39	00h	Enabled	6-28
Trioptic Code 39	0Dh	Disabled	6-28
Convert Code 39 to Code 32 (Italian Pharmacy Code)	56h	Disabled	6-29
Code 32 Prefix	E7h	Disabled	6-29
Set Length(s) for Code 39	12h 13h	2 to 55	6-30
Code 39 Check Digit Verification	30h	Disabled	6-31
Transmit Code 39 Check Digit	2Bh	Disabled	6-31
Code 39 Full ASCII Conversion	11h	Disabled	6-32
Buffer Code 39	71h	Disabled	6-32
Code 93			
Code 93	09h	Disabled	6-35

Table 6-1 *Parameter Defaults (Continued)*

Parameter	Parameter Number	Default	Page Number
Set Length(s) for Code 93	1Ah 1Bh	4 to 55	6-35
Code 11			
Code 11	0Ah	Disabled	6-37
Set Lengths for Code 11	1Ch 1Dh	4 to 55	6-37
Code 11 Check Digit Verification	34h	Disabled	6-39
Transmit Code 11 Check Digit(s)	2Fh	Disabled	6-40
Interleaved 2 of 5 (ITF)			
Interleaved 2 of 5 (ITF)	06h	Disabled	6-40
Set Lengths for I 2 of 5	16h 17h	14	6-41
I 2 of 5 Check Digit Verification	31h	Disabled	6-43
Transmit I 2 of 5 Check Digit	2Ch	Disabled	6-43
Convert I 2 of 5 to EAN 13	52h	Disabled	6-44
Discrete 2 of 5 (DTF)			
Discrete 2 of 5	05h	Disabled	6-44
Set Length(s) for D 2 of 5	14h 15h	12	6-45
Codabar (NW - 7)			
Codabar	07h	Disabled	6-47
Set Lengths for Codabar	18h 19h	5 to 55	6-47
CLSI Editing	36h	Disabled	6-49
NOTIS Editing	37h	Disabled	6-49
MSI			
MSI	0Bh	Disabled	6-50
Set Length(s) for MSI	1Eh 1Fh	4 to 55	6-50
MSI Check Digits	32h	One	6-52
Transmit MSI Check Digit	2Eh	Disabled	6-52
MSI Check Digit Algorithm	33h	Mod 10/Mod 10	6-53
Chinese 2 of 5			
Chinese 2 of 5	F0h 98h	Disabled	6-53

Table 6-1 *Parameter Defaults (Continued)*

Parameter	Parameter Number	Default	Page Number
Matrix 2 of 5			
Matrix 2 of 5	F1h 6Ah	Disabled	6-54
Matrix 2 of 5 Lengths	F1h 6Bh F1h 6Ch	1 Length - 14	6-55
Matrix 2 of 5 Redundancy	F1h 6Dh	Disabled	6-56
Matrix 2 of 5 Check Digit	F1h 6Eh	Disabled	6-56
Transmit Matrix 2 of 5 Check Digit	F1h 6Fh	Disabled	6-57
Inverse 1D	F1h 4Ah	Regular	6-57
Postal Codes			
US Postnet	59h	Disabled	6-58
US Planet	5Ah	Disabled	6-58
Transmit US Postal Check Digit	5Fh	Enabled	6-59
UK Postal	5Bh	Disabled	6-59
Transmit UK Postal Check Digit	60h	Enabled	6-60
Japan Postal	F0h 22h	Disabled	6-60
Australian Postal	F0h 23h	Disabled	6-61
Netherlands KIX Code	F0h 46h	Disabled	6-61
USPS 4CB/One Code/Intelligent Mail	F1h 50h	Disabled	6-62
UPU FICS Postal	F1h 63h	Disabled	6-62
GS1 DataBar			
GS1 DataBar-14	F0h 52h	Disabled	6-63
GS1 DataBar Limited	F0h 53h	Disabled	6-63
GS1 DataBar Expanded	F0h 54h	Disabled	6-64
Convert GS1 DataBar to UPC/EAN	F0h 8Dh	Disabled	6-64
Composite			
Composite CC-C	F0h 55h	Disabled	6-65
Composite CC-A/B	F0h 56h	Disabled	6-65
Composite TLC-39	F0h 73h	Disabled	6-66
UPC Composite Mode	F0h 58h	Never Linked	6-66
Composite Beep Mode	F0h 8Eh	Beep As Each Code Type is Decoded	6-67

Table 6-1 *Parameter Defaults (Continued)*

Parameter	Parameter Number	Default	Page Number
GS1-128 Emulation Mode for UCC/EAN Composite Codes	F0h ABh	Disabled	6-67
2D Symbologies			
PDF417	0Fh	Enabled	6-68
MicroPDF417	E3h	Disabled	6-68
Code 128 Emulation	7Bh	Disabled	6-69
Data Matrix	F0h 24h	Enabled	6-70
Data Matrix Inverse	F1h 4Ch	Regular	6-70
Maxicode	F0h 26h	Disabled	6-71
QR Code	F0h 25h	Enabled	6-71
QR Inverse	F1h 4Bh	Regular	6-72
MicroQR	F1h 3Dh	Enabled	6-72
Aztec	F1h 3Eh	Enabled	6-73
Aztec Inverse	F1h 4Dh	Regular	6-73
Symbology-Specific Security Levels			
Redundancy Level	4Eh	1	6-74
Security Level	4Dh	0	6-76
Intercharacter Gap Size	F0h 7Dh	Normal	6-77
Report Version			6-77
Macro PDF			
Flush Macro PDF Buffer			6-78
Abort Macro PDF Entry			6-78

UPC/EAN

Enable/Disable UPC-A

Parameter # 01h

To enable or disable UPC-A, scan the appropriate bar code below.

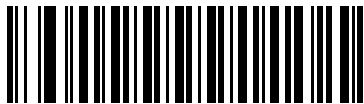

***Enable UPC-A
(01h)**

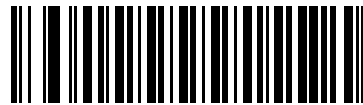

**Disable UPC-A
(00h)**

Enable/Disable UPC-E

Parameter # 02h

To enable or disable UPC-E, scan the appropriate bar code below.

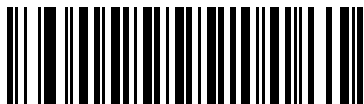

***Enable UPC-E
(01h)**



**Disable UPC-E
(00h)**

Enable/Disable UPC-E1

Parameter # 0Ch

UPC-E1 is disabled by default.

To enable or disable UPC-E1, scan the appropriate bar code below.

✓ **NOTE** UPC-E1 is not a UCC (Uniform Code Council) approved symbology.

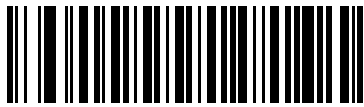

Enable UPC-E1
(01h)

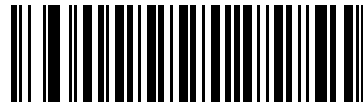

*Disable UPC-E1
(00h)

Enable/Disable EAN-8/JAN-8

Parameter # 04h

To enable or disable EAN-8/JAN-8, scan the appropriate bar code below.

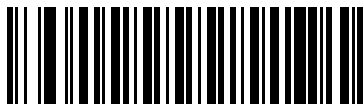

*Enable EAN-8/JAN-8
(01h)

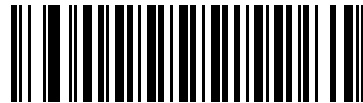

Disable EAN-8/JAN-8
(00h)

Enable/Disable EAN-13/JAN-13

Parameter # 03h

To enable or disable EAN-13/JAN-13, scan the appropriate bar code below.

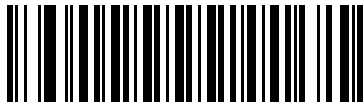

*Enable EAN-13/JAN-13
(01h)



Disable EAN-13/JAN-13
(00h)

Enable/Disable Bookland EAN

Parameter # 53h

To enable or disable Bookland EAN, scan the appropriate bar code below.

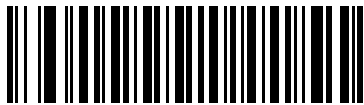

Enable Bookland EAN
(01h)



*Disable Bookland EAN
(00h)



NOTE If you enable Bookland EAN, select a [Bookland ISBN Format on page 6-21](#). Also select either Decode UPC/EAN Supplementals, Autodiscriminate UPC/EAN Supplementals, or Enable 978/979 Supplemental Mode in [Decode UPC/EAN/JAN Supplementals on page 6-10](#).

Decode UPC/EAN/JAN Supplementals

Parameter # 10h

Supplementals are bar codes appended according to specific format conventions (e.g., UPC A+2, UPC E+2, EAN 13+2). The following options are available:

- If you select **Ignore UPC/EAN with Supplementals**, and the digital scanner is presented with a UPC/EAN plus supplemental symbol, the scanner decodes UPC/EAN and ignores the supplemental characters.
- If you select **Decode UPC/EAN with Supplementals**, the digital scanner only decodes UPC/EAN symbols with supplemental characters, and ignores symbols without supplementals.
- If you select **Autodiscriminate UPC/EAN Supplementals**, the digital scanner decodes UPC/EAN symbols with supplemental characters immediately. If the symbol does not have a supplemental, the digital scanner must decode the bar code the number of times set via [UPC/EAN/JAN Supplemental Redundancy on page 6-13](#) before transmitting its data to confirm that there is no supplemental.
- If you select one of the following **Supplemental Mode** options, the digital scanner immediately transmits EAN-13 bar codes starting with that prefix that have supplemental characters. If the symbol does not have a supplemental, the digital scanner must decode the bar code the number of times set via [UPC/EAN/JAN Supplemental Redundancy on page 6-13](#) before transmitting its data to confirm that there is no supplemental. The digital scanner transmits UPC/EAN bar codes that do not have that prefix immediately.
 - Enable 378/379 Supplemental Mode
 - **Enable 978/979 Supplemental Mode**

✓ **NOTE** If you select 978/979 Supplemental Mode and are scanning Bookland EAN bar codes, see [Enable/Disable Bookland EAN on page 6-9](#) to enable Bookland EAN, and select a format using [Bookland ISBN Format on page 6-21](#).

- Enable 977 Supplemental Mode
- Enable 414/419/434/439 Supplemental Mode
- Enable 491 Supplemental Mode
- **Enable Smart Supplemental Mode** - applies to EAN-13 bar codes starting with any prefix listed previously.
- **Supplemental User-Programmable Type 1** - applies to EAN-13 bar codes starting with a 3-digit user-defined prefix. Set this 3-digit prefix using [User-Programmable Supplementals on page 6-13](#).
- **Supplemental User-Programmable Type 1 and 2** - applies to EAN-13 bar codes starting with either of two 3-digit user-defined prefixes. Set the 3-digit prefixes using [User-Programmable Supplementals on page 6-13](#).
- **Smart Supplemental Plus User-Programmable 1** - applies to EAN-13 bar codes starting with any prefix listed previously or the user-defined prefix set using [User-Programmable Supplementals on page 6-13](#).
- **Smart Supplemental Plus User-Programmable 1 and 2** - applies to EAN-13 bar codes starting with any prefix listed previously or one of the two user-defined prefixes set using [User-Programmable Supplementals on page 6-13](#).

✓ **NOTE** To minimize the risk of invalid data transmission, select either to decode or ignore supplemental characters.

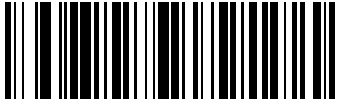
Decode UPC/EAN/JAN Supplementals (continued)

**Decode UPC/EAN/JAN Only With Supplementals
(01h)**



***Ignore Supplementals
(00h)**

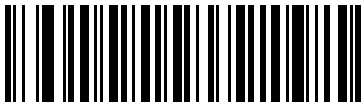

**Autodiscriminate UPC/EAN/JAN Supplementals
(02h)**



**Enable 378/379 Supplemental Mode
(04h)**



**Enable 978/979 Supplemental Mode
(05h)**



**Enable 977 Supplemental Mode
(07h)**

Decode UPC/EAN/JAN Supplementals (continued)



Enable 414/419/434/439 Supplemental Mode
(06h)



Enable 491 Supplemental Mode
(08h)



Enable Smart Supplemental Mode
(03h)



Supplemental User-Programmable Type 1
(09h)



Supplemental User-Programmable Type 1 and 2
(0Ah)



Smart Supplemental Plus User-Programmable 1
(0Bh)



Smart Supplemental Plus User-Programmable 1 and 2
(0Ch)

User-Programmable Supplementals

Supplemental 1: Parameter # F1h 43h

Supplemental 2: Parameter # F1h 44h

If you selected a Supplemental User-Programmable option from [Decode UPC/EAN/JAN Supplementals on page 6-10](#), select **User-Programmable Supplemental 1** to set the 3-digit prefix. Then select the 3 digits using the numeric bar codes beginning on [page D-1](#). Select **User-Programmable Supplemental 2** to set a second 3-digit prefix. Then select the 3 digits using the numeric bar codes beginning on [page D-1](#).



User-Programmable Supplemental 1



User-Programmable Supplemental 2

UPC/EAN/JAN Supplemental Redundancy

Parameter # 50h

If you selected **Autodiscriminate UPC/EAN/JAN Supplementals**, this option adjusts the number of times to decode a symbol without supplementals before transmission. The range is from two to thirty times. Five or above is recommended when decoding a mix of UPC/EAN/JAN symbols with and without supplementals. The default is 10.

Scan the bar code below to set a decode redundancy value. Next, scan two numeric bar codes in [Appendix D, Numeric Bar Codes](#). Enter a leading zero for single digit numbers. To correct an error or change a selection, scan [Cancel on page D-2](#).

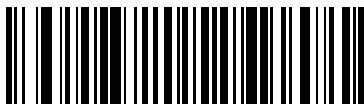

UPC/EAN/JAN Supplemental Redundancy

UPC/EAN/JAN Supplemental AIM ID Format

Parameter # F1h A0h

Select an output format when reporting UPC/EAN/JAN bar codes with supplementals with AIM ID enabled:

- Separate - UPC/EAN with supplementals transmit as]E<0 or 4><data>]E<1 or 2>[supp data]
- Combined - EAN-8 with supplementals transmit as]E4<data>]E<1 or 2>[supp data]
All other UPC/EAN with supplementals transmit as]E3<data+supps>



Separate
(00h)

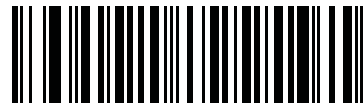

*Combined
(01h)

Transmit UPC-A Check Digit

Parameter # 28h

The check digit is the last character of the symbol used to verify the integrity of the data. Scan the appropriate bar code below to transmit the bar code data with or without the UPC-A check digit. It is always verified to guarantee the integrity of the data.

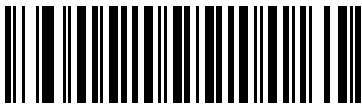

*Transmit UPC-A Check Digit
(01h)



Do Not Transmit UPC-A Check Digit
(00h)

Transmit UPC-E Check Digit

Parameter # 29h

The check digit is the last character of the symbol used to verify the integrity of the data. Scan the appropriate bar code below to transmit the bar code data with or without the UPC-E check digit. It is always verified to guarantee the integrity of the data.

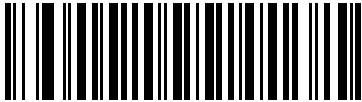

***Transmit UPC-E Check Digit
(01h)**

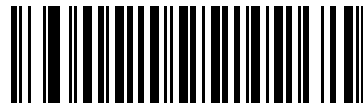

**Do Not Transmit UPC-E Check Digit
(00h)**

Transmit UPC-E1 Check Digit

Parameter # 2Ah

The check digit is the last character of the symbol used to verify the integrity of the data. Scan the appropriate bar code below to transmit the bar code data with or without the UPC-E1 check digit. It is always verified to guarantee the integrity of the data.



***Transmit UPC-E1 Check Digit
(01h)**

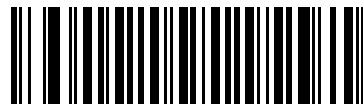

**Do Not Transmit UPC-E1 Check Digit
(00h)**

UPC-A Preamble

Parameter # 22h

Preamble characters are part of the UPC symbol, and include Country Code and System Character. There are three options for transmitting a UPC-A preamble to the host device: transmit System Character only, transmit System Character and Country Code ("0" for USA), and transmit no preamble. Select the appropriate option to match the host system.

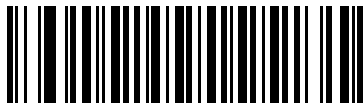

No Preamble (<DATA>)
(00h)

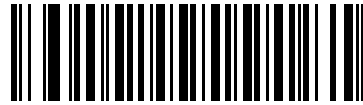

*System Character (<SYSTEM CHARACTER> <DATA>)
(01h)

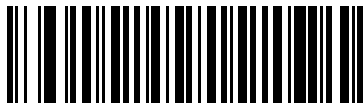

System Character & Country Code
(< COUNTRY CODE> <SYSTEM CHARACTER> <DATA>)
(02h)

UPC-E Preamble

Parameter # 23h

Preamble characters are part of the UPC symbol, and include Country Code and System Character. There are three options for transmitting a UPC-E preamble to the host device: transmit System Character only, transmit System Character and Country Code ("0" for USA), and transmit no preamble. Select the appropriate option to match the host system.

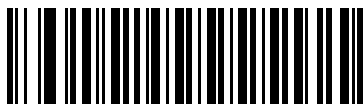

No Preamble (<DATA>)
(00h)



*System Character (<SYSTEM CHARACTER> <DATA>)
(01h)

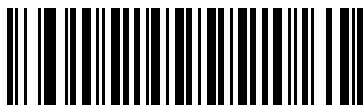

System Character & Country Code
(< COUNTRY CODE> <SYSTEM CHARACTER> <DATA>)
(02h)

UPC-E1 Preamble

Parameter # 24h

Preamble characters are part of the UPC symbol, and include Country Code and System Character. There are three options for transmitting a UPC-E1 preamble to the host device: transmit System Character only, transmit System Character and Country Code ("0" for USA), and transmit no preamble. Select the appropriate option to match the host system.

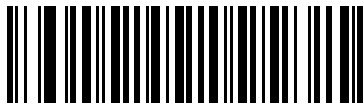

No Preamble (<DATA>)
(00h)

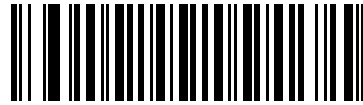

*System Character (<SYSTEM CHARACTER> <DATA>)
(01h)

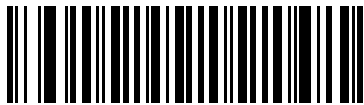

System Character & Country Code
(< COUNTRY CODE> <SYSTEM CHARACTER> <DATA>)
(02h)

Convert UPC-E to UPC-A

Parameter # 25h

Enable this to convert UPC-E (zero suppressed) decoded data to UPC-A format before transmission. After conversion, the data follows UPC-A format and is affected by UPC-A programming selections (e.g., Preamble, Check Digit).

Disable this to transmit UPC-E decoded data as UPC-E data, without conversion.

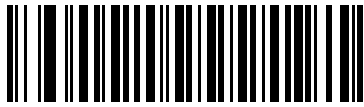

Convert UPC-E to UPC-A (Enable)
(01h)

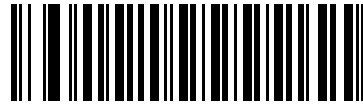

*Do Not Convert UPC-E to UPC-A (Disable)
(00h)

Convert UPC-E1 to UPC-A

Parameter # 26h

Enable this to convert UPC-E1 decoded data to UPC-A format before transmission. After conversion, the data follows UPC-A format and is affected by UPC-A programming selections (e.g., Preamble, Check Digit).

Disable this to transmit UPC-E1 decoded data as UPC-E1 data, without conversion.

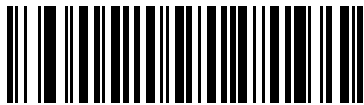

Convert UPC-E1 to UPC-A (Enable)
(01h)



*Do Not Convert UPC-E1 to UPC-A (Disable)
(00h)

EAN-8/JAN-8 Extend

Parameter # 27h

Enable this parameter to add five leading zeros to decoded EAN-8 symbols to make them compatible in format to EAN-13 symbols.

Disable this to transmit EAN-8 symbols as is.

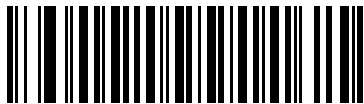

**Enable EAN/JAN Zero Extend
(01h)**

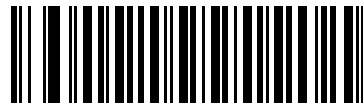

***Disable EAN/JAN Zero Extend
(00h)**

Bookland ISBN Format

Parameter # F1h 40h

If you enabled Bookland EAN using [Enable/Disable Bookland EAN on page 6-9](#), select one of the following formats for Bookland data:

- **Bookland ISBN-10** - The digital scanner reports Bookland data starting with 978 in traditional 10-digit format with the special Bookland check digit for backward-compatibility. Data starting with 979 is not considered Bookland in this mode.
- **Bookland ISBN-13** - The digital scanner reports Bookland data (starting with either 978 or 979) as EAN-13 in 13-digit format to meet the 2007 ISBN-13 protocol.



***Bookland ISBN-10**
(00h)



Bookland ISBN-13
(01h)



NOTE For Bookland EAN to function properly, first enable Bookland EAN using [Enable/Disable Bookland EAN on page 6-9](#), then select either Decode UPC/EAN Supplementals, Autodiscriminate UPC/EAN Supplementals, or Enable 978/979 Supplemental Mode in [Decode UPC/EAN/JAN Supplementals on page 6-10](#).

UCC Coupon Extended Code

Parameter # 55h

Enable this parameter to decode UPC-A bar codes starting with digit '5', EAN-13 bar codes starting with digit '99', and UPC-A/GS1-128 Coupon Codes. UPCA, EAN-13, and GS1-128 must be enabled to scan all types of Coupon Codes.

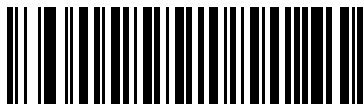

*Enable UCC Coupon Extended Code
(01h)



Disable UCC Coupon Extended Code
(00h)



NOTE See [UPC/EAN/JAN Supplemental Redundancy on page 6-13](#) to control autodiscrimination of the GS1-128 (right half) of a coupon code.

ISSN EAN

Parameter # F1h 69h

To enable or disable ISSN EAN, scan the appropriate bar code below.



Enable ISSN EAN
(01h)

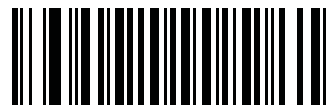

*Disable ISSN EAN
(00h)

Code 128

Enable/Disable Code 128

Parameter # 08h

To enable or disable Code 128, scan the appropriate bar code below.



*Enable Code 128
(01h)

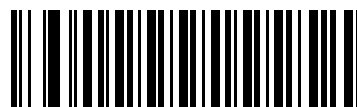

Disable Code 128
(00h)

Set Lengths for Code 128

Parameter # L1 = D1h, L2 = D2h

The length of a code refers to the number of characters (i.e., human readable characters), including check digit(s) the code contains. Set lengths for Code 128 to any length, one or two discrete lengths, or lengths within a specific range.

✓ **NOTE** When setting lengths for different bar code types, enter a leading zero for single digit numbers.

- **One Discrete Length** - Select this option to decode only Code 128 symbols containing a selected length. Select the length using the numeric bar codes in [Appendix D, Numeric Bar Codes](#). For example, to decode only Code 128 symbols with 14 characters, scan **Code 128 - One Discrete Length**, then scan **1** followed by **4**. To correct an error or change the selection, scan [Cancel on page D-2](#).
- **Two Discrete Lengths** - Select this option to decode only Code 128 symbols containing either of two selected lengths. Select lengths using the numeric bar codes in [Appendix D, Numeric Bar Codes](#). For example, to decode only Code 128 symbols containing either 2 or 14 characters, select **Code 128 - Two Discrete Lengths**, then scan **0, 2, 1**, and then **4**. To correct an error or change the selection, scan [Cancel on page D-2](#).
- **Length Within Range** - Select this option to decode a Code 128 symbol with a specific length range. Select lengths using numeric bar codes in [Appendix D, Numeric Bar Codes](#). For example, to decode Code 128 symbols containing between 4 and 12 characters, first scan **Code 128 - Length Within Range**. Then scan **0, 4, 1**, and **2** (enter a leading zero for single digit numbers). To correct an error or change the selection, scan [Cancel on page D-2](#).
- **Any Length** - Select this option to decode Code 128 symbols containing any number of characters within the digital scanner's capability.

Set Lengths for Code 128 (continued)

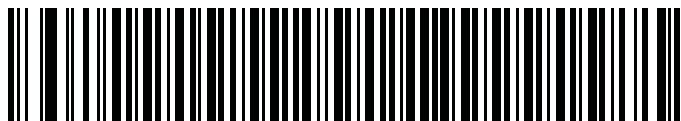

Code 128 - One Discrete Length



Code 128 - Two Discrete Lengths



Code 128 - Length Within Range



*Code 128 - Any Length

Enable/Disable GS1-128 (formerly UCC/EAN-128)

Parameter # 0Eh

To enable or disable GS1-128, scan the appropriate bar code below.

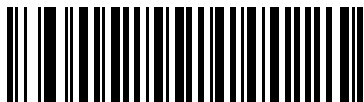

*Enable GS1-128
(01h)



Disable GS1-128
(00h)

Enable/Disable ISBT 128

Parameter # 54h

ISBT 128 is a variant of Code 128 used in the blood bank industry. Scan a bar code below to enable or disable ISBT 128. If necessary, the host must perform concatenation of the ISBT data.



***Enable ISBT 128
(01h)**



**Disable ISBT 128
(00h)**

ISBT Concatenation

Parameter # F1h 41h

Select an option for concatenating pairs of ISBT code types:

- If you select **Disable ISBT Concatenation**, the digital scanner does not concatenate pairs of ISBT codes it encounters.
- If you select **Enable ISBT Concatenation**, there must be two ISBT codes in order for the digital scanner to decode and perform concatenation. The digital scanner does not decode single ISBT symbols.
- If you select **Autodiscriminate ISBT Concatenation**, the digital scanner decodes and concatenates pairs of ISBT codes immediately. If only a single ISBT symbol is present, the digital scanner must decode the symbol the number of times set via [ISBT Concatenation Redundancy on page 6-27](#) before transmitting its data to confirm that there is no additional ISBT symbol.



*Disable ISBT Concatenation
(00h)



Enable ISBT Concatenation
(01h)



Autodiscriminate ISBT Concatenation
(00h)

Check ISBT Table

Parameter # F1h 42h

The ISBT specification includes a table that lists several types of ISBT bar codes that are commonly used in pairs. If you set **ISBT Concatenation** to **Enable**, enable **Check ISBT Table** to concatenate only those pairs found in this table. Other types of ISBT codes are not concatenated.

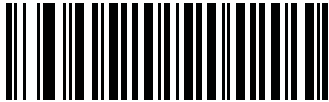

*Enable Check ISBT Table
(01h)



Disable Check ISBT Table
(00h)

ISBT Concatenation Redundancy

Parameter # DFh

If you set **ISBT Concatenation** to **Autodiscriminate**, use this parameter to set the number of times the digital scanner must decode an ISBT symbol before determining that there is no additional symbol.

Scan the bar code below, then scan two numeric bar codes in [Appendix D, Numeric Bar Codes](#) to set a value between 2 and 20. Enter a leading zero for single digit numbers. To correct an error or change a selection, scan [Cancel on page D-2](#). The default is 10.



ISBT Concatenation Redundancy

Code 39

Enable/Disable Code 39

Parameter # 00h

To enable or disable Code 39, scan the appropriate bar code below.

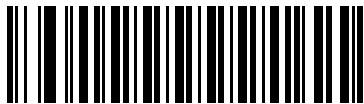

***Enable Code 39
(01h)**

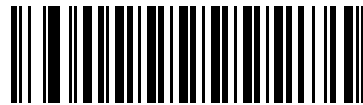

**Disable Code 39
(00h)**

Enable/Disable Trioptic Code 39

Parameter # 0Dh

Trioptic Code 39 is a variant of Code 39 used in the marking of computer tape cartridges. Trioptic Code 39 symbols always contain six characters. To enable or disable Trioptic Code 39, scan the appropriate bar code below.

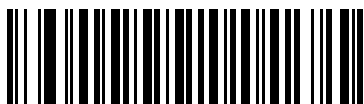

**Enable Trioptic Code 39
(01h)**



***Disable Trioptic Code 39
(00h)**



NOTE You cannot enable Trioptic Code 39 and Code 39 Full ASCII simultaneously.

Convert Code 39 to Code 32

Parameter # 56h

Code 32 is a variant of Code 39 used by the Italian pharmaceutical industry. Scan the appropriate bar code below to enable or disable converting Code 39 to Code 32.

✓ **NOTE** Code 39 must be enabled for this parameter to function.



Enable Convert Code 39 to Code 32
(01h)

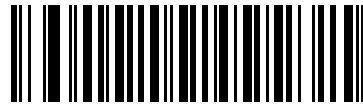

*Disable Convert Code 39 to Code 32
(00h)

Code 32 Prefix

Parameter # E7h

Scan the appropriate bar code below to enable or disable adding the prefix character “A” to all Code 32 bar codes.

✓ **NOTE** Convert Code 39 to Code 32 must be enabled for this parameter to function.

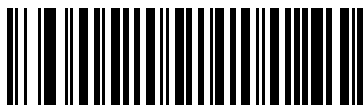

Enable Code 32 Prefix
(01h)



*Disable Code 32 Prefix
(00h)

Set Lengths for Code 39

Parameter # L1 = 12h, L2 = 13h

The length of a code refers to the number of characters (i.e., human readable characters), including check digit(s) the code contains. Set lengths for Code 39 to any length, one or two discrete lengths, or lengths within a specific range. If Code 39 Full ASCII is enabled, **Length Within a Range** or **Any Length** are the preferred options.

✓ **NOTE** When setting lengths for different bar code types, enter a leading zero for single digit numbers.

- **One Discrete Length** - Select this option to decode only Code 39 symbols containing a selected length. Select the length using the numeric bar codes in [Appendix D, Numeric Bar Codes](#). For example, to decode only Code 39 symbols with 14 characters, scan **Code 39 - One Discrete Length**, then scan **1** followed by **4**. To correct an error or change the selection, scan [Cancel on page D-2](#).
- **Two Discrete Lengths** - Select this option to decode only Code 39 symbols containing either of two selected lengths. Select lengths using the numeric bar codes in [Appendix D, Numeric Bar Codes](#). For example, to decode only Code 39 symbols containing either 2 or 14 characters, select **Code 39 - Two Discrete Lengths**, then scan **0, 2, 1**, and then **4**. To correct an error or change the selection, scan [Cancel on page D-2](#).
- **Length Within Range** - Select this option to decode a Code 39 symbol with a specific length range. Select lengths using numeric bar codes in [Appendix D, Numeric Bar Codes](#). For example, to decode Code 39 symbols containing between 4 and 12 characters, first scan **Code 39 - Length Within Range**. Then scan **0, 4, 1**, and **2** (enter a leading zero for single digit numbers). To correct an error or change the selection, scan [Cancel on page D-2](#).
- **Any Length** - Select this option to decode Code 39 symbols containing any number of characters within the digital scanner's capability.



Code 39 - One Discrete Length



Code 39 - Two Discrete Lengths



Code 39 - Length Within Range



Code 39 - Any Length

Code 39 Check Digit Verification

Parameter # 30h

Enable this feature to check the integrity of all Code 39 symbols to verify that the data complies with specified check digit algorithm. Only Code 39 symbols which include a modulo 43 check digit are decoded. Enable this feature if the Code 39 symbols contain a Modulo 43 check digit.

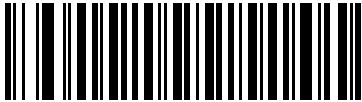

Enable Code 39 Check Digit
(01h)



*Disable Code 39 Check Digit
(00h)

Transmit Code 39 Check Digit

Parameter # 2Bh

Scan a bar code below to transmit Code 39 data with or without the check digit.



Transmit Code 39 Check Digit (Enable)
(01h)



*Do Not Transmit Code 39 Check Digit (Disable)
(00h)



NOTE Code 39 Check Digit Verification must be enabled for this parameter to function.

Code 39 Full ASCII Conversion

Parameter # 11h

Code 39 Full ASCII is a variant of Code 39 which pairs characters to encode the full ASCII character set. To enable or disable Code 39 Full ASCII, scan the appropriate bar code below.

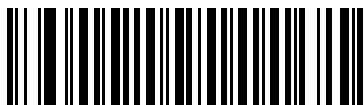

Enable Code 39 Full ASCII
(01h)



*Disable Code 39 Full ASCII
(00h)



NOTE You cannot enable Trioptic Code 39 and Code 39 Full ASCII simultaneously.

Code 39 Full ASCII to Full ASCII Correlation is host-dependent, and is therefore described in the ASCII Character Set Table for the appropriate interface.

Code 39 Buffering - Scan & Store

Parameter # 71h

This feature allows the digital scanner to accumulate data from multiple Code 39 symbols.

Selecting the Scan and Store option (Buffer Code 39) temporarily buffers all Code 39 symbols having a leading space as a first character for later transmission. The leading space is not buffered.

Decoding a Code 39 symbol with no leading space transmits in sequence all buffered data in a first-in first-out format, plus the "triggering" symbol. See the following pages for further details.

Select **Do Not Buffer Code 39** to transmit all decoded Code 39 symbols immediately without storing them in the buffer.

Code 39 Buffering - Scan & Store (continued)

This feature affects Code 39 only. If selecting **Buffer Code 39**, we recommend configuring the digital scanner to decode Code 39 symbology only.

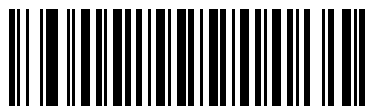

Buffer Code 39 (Enable)
(01h)

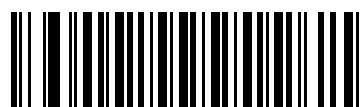

***Do Not Buffer Code 39 (Disable)**
(00h)

While there is data in the transmission buffer, you cannot select **Do Not Buffer Code 39**. The buffer holds 200 bytes of information.

To disable Code 39 buffering when there is data in the transmission buffer, first force the buffer transmission (see [Transmit Buffer on page 6-34](#)) or clear the buffer.

Buffer Data

To buffer data, enable Code 39 buffering and scan a Code 39 symbol with a space immediately following the start pattern.

- Unless the data overflows the transmission buffer, the digital scanner issues a low/high beep to indicate successful decode and buffering. (For overflow conditions, see [Overfilling Transmission Buffer on page 6-34](#).)
- The digital scanner adds the decoded data excluding the leading space to the transmission buffer.
- No transmission occurs.

Clear Transmission Buffer

To clear the transmission buffer, scan the **Clear Buffer** bar code below, which contains only a start character, a dash (minus), and a stop character.

- The digital scanner issues a short high/low/high beep.
- The digital scanner erases the transmission buffer.
- No transmission occurs.



Clear Buffer

- ✓ **NOTE** The Clear Buffer contains only the dash (minus) character. In order to scan this command, set Code 39 lengths to include length 1.

Transmit Buffer

There are two methods to transmit the Code 39 buffer.

1. Scan the **Transmit Buffer** bar code below, which includes only a start character, a plus (+), and a stop character.
2. The digital scanner transmits and clears the buffer.
 - The digital scanner issues a low/high beep.



Transmit Buffer

3. Scan a Code 39 bar code with a leading character other than a space.
 - The digital scanner appends new decode data to buffered data.
 - The digital scanner transmits and clears the buffer.
 - The digital scanner signals that it transmitted the buffer with a low/high beep.
 - The digital scanner transmits and clears the buffer.

- ✓ **NOTE** The Transmit Buffer contains only a plus (+) character. In order to scan this command, set Code 39 lengths to include length 1.

Overfilling Transmission Buffer

The Code 39 buffer holds 200 characters. If the symbol just read overflows the transmission buffer:

- The digital scanner indicates that it rejected the symbol by issuing three long, high beeps.
- No transmission occurs. The data in the buffer is not affected.

Attempt to Transmit an Empty Buffer

If you scan the **Transmit Buffer** symbol and the Code 39 buffer is empty:

- A short low/high/low beep signals that the buffer is empty.
- No transmission occurs.
- The buffer remains empty.

Code 93

Enable/Disable Code 93

Parameter # 09h

To enable or disable Code 93, scan the appropriate bar code below.



Enable Code 93
(01h)



*Disable Code 93
(00h)

Set Lengths for Code 93

Parameter # L1 = 1Ah, L2 = 1Bh

The length of a code refers to the number of characters (i.e., human readable characters), including check digit(s) the code contains. Set lengths for Code 93 to any length, one or two discrete lengths, or lengths within a specific range.

- **One Discrete Length** - Select this option to decode only Code 93 symbols containing a selected length. Select the length using the numeric bar codes in [Appendix D, Numeric Bar Codes](#). For example, to decode only Code 93 symbols with 14 characters, scan **Code 93 - One Discrete Length**, then scan **1** followed by **4**. To correct an error or to change the selection, scan [Cancel on page D-2](#).
- **Two Discrete Lengths** - Select this option to decode only Code 93 symbols containing either of two selected lengths. Select lengths using the numeric bar codes in [Appendix D, Numeric Bar Codes](#). For example, to decode only Code 93 symbols containing either 2 or 14 characters, select **Code 93 - Two Discrete Lengths**, then scan **0, 2, 1**, and then **4**. To correct an error or to change the selection, scan [Cancel on page D-2](#).
- **Length Within Range** - Select this option to decode a Code 93 symbol with a specific length range. Select lengths using the numeric bar codes in [Appendix D, Numeric Bar Codes](#). For example, to decode Code 93 symbols containing between 4 and 12 characters, first scan **Code 93 - Length Within Range**. Then scan **0, 4, 1**, and **2** (enter a leading zero for single digit numbers). To correct an error or change the selection, scan [Cancel on page D-2](#).
- **Any Length** - Scan this option to decode Code 93 symbols containing any number of characters within the digital scanner's capability.

Set Lengths for Code 93 (continued)



Code 93 - One Discrete Length



Code 93 - Two Discrete Lengths



Code 93 - Length Within Range



Code 93 - Any Length

Code 11

Code 11

Parameter # 0Ah

To enable or disable Code 11, scan the appropriate bar code below.



Enable Code 11
(01h)

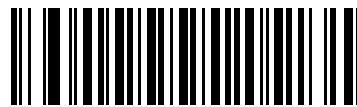

*Disable Code 11
(00h)

Set Lengths for Code 11

Parameter # L1 = 1Ch, L2 = 1Dh

The length of a code refers to the number of characters (i.e., human readable characters), including check digit(s) the code contains. Set lengths for Code 11 to any length, one or two discrete lengths, or lengths within a specific range.

- **One Discrete Length** - Select this option to decode only Code 11 symbols containing a selected length. Select the length using the numeric bar codes in [Appendix D, Numeric Bar Codes](#). For example, to decode only Code 11 symbols with 14 characters, scan **Code 11 - One Discrete Length**, then scan **1** followed by **4**. To correct an error or to change the selection, scan [Cancel on page D-2](#).
- **Two Discrete Lengths** - Select this option to decode only Code 11 symbols containing either of two selected lengths. Select lengths using the numeric bar codes in [Appendix D, Numeric Bar Codes](#). For example, to decode only Code 11 symbols containing either 2 or 14 characters, select **Code 11 - Two Discrete Lengths**, then scan **0, 2, 1**, and then **4**. To correct an error or to change the selection, scan [Cancel on page D-2](#).
- **Length Within Range** - Select this option to decode a Code 11 symbol with a specific length range. Select lengths using numeric bar codes in [Appendix D, Numeric Bar Codes](#). For example, to decode Code 11 symbols containing between 4 and 12 characters, first scan **Code 11 - Length Within Range**. Then scan **0, 4, 1**, and **2** (enter a leading zero for single digit numbers). To correct an error or change the selection, scan [Cancel on page D-2](#).
- **Any Length** - Scan this option to decode Code 11 symbols containing any number of characters within the digital scanner's capability.

Set Lengths for Code 11 (continued)



Code 11 - One Discrete Length



Code 11 - Two Discrete Lengths



Code 11 - Length Within Range



Code 11 - Any Length

Code 11 Check Digit Verification

Parameter # 34h

This feature allows the digital scanner to check the integrity of all Code 11 symbols to verify that the data complies with the specified check digit algorithm. This selects the check digit mechanism for the decoded Code 11 bar code. The options are to check for one check digit, check for two check digits, or disable the feature.

To enable this feature, scan the bar code below corresponding to the number of check digits encoded in the Code 11 symbols.



***Disable
(00h)**

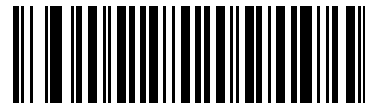

**One Check Digit
(01h)**

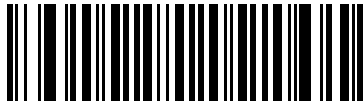

**Two Check Digits
(02h)**

Transmit Code 11 Check Digits

Parameter # 2Fh

This feature selects whether or not to transmit the Code 11 check digit(s).

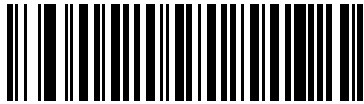

Transmit Code 11 Check Digit(s) (Enable)
(01h)

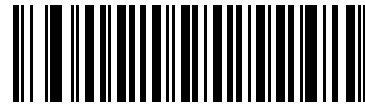

*Do Not Transmit Code 11 Check Digit(s) (Disable)
(00h)



NOTE Code 11 Check Digit Verification must be enabled for this parameter to function.

Interleaved 2 of 5 (ITF)

Enable/Disable Interleaved 2 of 5

Parameter # 06h

To enable or disable Interleaved 2 of 5, scan the appropriate bar code below, and select an Interleaved 2 of 5 length from the following pages.

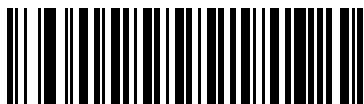

Enable Interleaved 2 of 5
(01h)

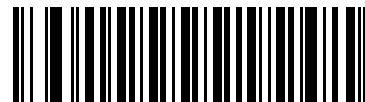

*Disable Interleaved 2 of 5
(00h)

Set Lengths for Interleaved 2 of 5

Parameter # L1 = 16h, L2 = 17h

The length of a code refers to the number of characters (i.e., human readable characters), including check digit(s) the code contains. Set lengths for I 2 of 5 to any length, one or two discrete lengths, or lengths within a specific range. The range for Interleaved 2 of 5 lengths is 0 - 55.

- **One Discrete Length** - Select this option to decode only I 2 of 5 symbols containing a selected length. Select the length using the numeric bar codes in [Appendix D, Numeric Bar Codes](#). For example, to decode only I 2 of 5 symbols with 14 characters, scan **I 2 of 5 - One Discrete Length**, then scan **1** followed by **4**. To correct an error or to change the selection, scan [Cancel on page D-2](#).
- **Two Discrete Lengths** - Select this option to decode only I 2 of 5 symbols containing either of two selected lengths. Select lengths using the numeric bar codes in [Appendix D, Numeric Bar Codes](#). For example, to decode only I 2 of 5 symbols containing either 2 or 14 characters, select **I 2 of 5 - Two Discrete Lengths**, then scan **0, 2, 1**, and then **4**. To correct an error or to change the selection, scan [Cancel on page D-2](#).
- **Length Within Range** - Select this option to decode an I 2 of 5 symbol with a specific length range. Select lengths using numeric bar codes in [Appendix D, Numeric Bar Codes](#). For example, to decode I 2 of 5 symbols containing between 4 and 12 characters, first scan **I 2 of 5 - Length Within Range**. Then scan **0, 4, 1**, and **2** (enter a leading zero for single digit numbers). To correct an error or change the selection, scan [Cancel on page D-2](#).
- **Any Length** - Scan this option to decode I 2 of 5 symbols containing any number of characters within the digital scanner's capability.

✓ **NOTE** Due to the construction of the I 2 of 5 symbology, it is possible for a scan line covering only a portion of the code to transmit as a complete scan, yielding less data than is encoded in the bar code. To prevent this, select specific lengths (I 2 of 5 - One Discrete Length, Two Discrete Lengths) for I 2 of 5 applications.

Set Lengths for Interleaved 2 of 5 (continued)



I 2 of 5 - One Discrete Length



I 2 of 5 - Two Discrete Lengths



I 2 of 5 - Length Within Range



I 2 of 5 - Any Length

I 2 of 5 Check Digit Verification

Parameter # 31h

Enable this feature to check the integrity of all I 2 of 5 symbols to verify the data complies with either the specified Uniform Symbology Specification (USS), or the Optical Product Code Council (OPCC) check digit algorithm.



***Disable
(00h)**



**USS Check Digit
(01h)**



**OPCC Check Digit
(02h)**

Transmit I 2 of 5 Check Digit

Parameter # 2Ch

Scan the appropriate bar code below to transmit I 2 of 5 data with or without the check digit.

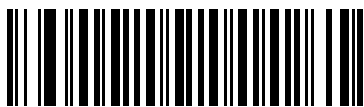

**Transmit I 2 of 5 Check Digit (Enable)
(01h)**



***Do Not Transmit I 2 of 5 Check Digit (Disable)
(00h)**

Convert I 2 of 5 to EAN-13

Parameter # 52h

Enable this parameter to convert 14-character I 2 of 5 codes to EAN-13, and transmit to the host as EAN-13. To accomplish this, the I 2 of 5 code must be enabled, and the code must have a leading zero and a valid EAN-13 check digit.

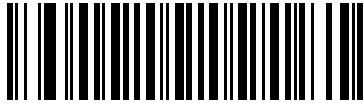

Convert I 2 of 5 to EAN-13 (Enable)
(01h)

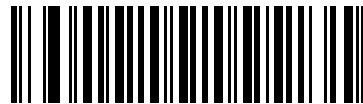

*Do Not Convert I 2 of 5 to EAN-13 (Disable)
(00h)

Discrete 2 of 5 (DTF)

Enable/Disable Discrete 2 of 5

Parameter # 05h

To enable or disable Discrete 2 of 5, scan the appropriate bar code below.

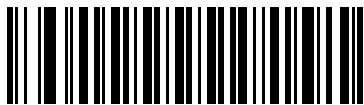

Enable Discrete 2 of 5
(01h)



*Disable Discrete 2 of 5
(00h)

Set Lengths for Discrete 2 of 5

Parameter # L1 = 14h, L2 = 15h

The length of a code refers to the number of characters (i.e., human readable characters), including check digit(s) the code contains. Set lengths for D 2 of 5 to any length, one or two discrete lengths, or lengths within a specific range. The range for Discrete 2 of 5 lengths is 0 - 55.

- **One Discrete Length** - Select this option to decode only D 2 of 5 symbols containing a selected length. Select the length using the numeric bar codes in [Appendix D, Numeric Bar Codes](#). For example, to decode only D 2 of 5 symbols with 14 characters, scan **D 2 of 5 - One Discrete Length**, then scan **1** followed by **4**. To correct an error or to change the selection, scan [Cancel on page D-2](#).
- **Two Discrete Lengths** - Select this option to decode only D 2 of 5 symbols containing either of two selected lengths. Select lengths using the numeric bar codes in [Appendix D, Numeric Bar Codes](#). For example, to decode only D 2 of 5 symbols containing either 2 or 14 characters, select **D 2 of 5 - Two Discrete Lengths**, then scan **0, 2, 1**, and then **4**. To correct an error or to change the selection, scan [Cancel on page D-2](#).
- **Length Within Range** - Select this option to decode a D 2 of 5 symbol with a specific length range. Select lengths using numeric bar codes in [Appendix D, Numeric Bar Codes](#). For example, to decode D 2 of 5 symbols containing between 4 and 12 characters, first scan **D 2 of 5 - Length Within Range**. Then scan **0, 4, 1**, and **2** (enter a leading zero for single digit numbers). To correct an error or change the selection, scan [Cancel on page D-2](#).
- **Any Length** - Scan this option to decode D 2 of 5 symbols containing any number of characters within the digital scanner's capability.

✓ **NOTE** Due to the construction of the D 2 of 5 symbology, it is possible for a scan line covering only a portion of the code to transmit as a complete scan, yielding less data than is encoded in the bar code. To prevent this, select specific lengths (**D 2 of 5 - One Discrete Length, Two Discrete Lengths**) for D 2 of 5 applications.

Set Lengths for Discrete 2 of 5 (continued)



D 2 of 5 - One Discrete Length



D 2 of 5 - Two Discrete Lengths



D 2 of 5 - Length Within Range



D 2 of 5 - Any Length

Codabar (NW - 7)

Enable/Disable Codabar

Parameter # 07h

To enable or disable Codabar, scan the appropriate bar code below.



Enable Codabar
(01h)

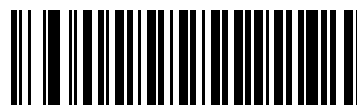

*Disable Codabar
(00h)

Set Lengths for Codabar

Parameter # L1 = 18h, L2 = 19h

The length of a code refers to the number of characters (i.e., human readable characters), including check digit(s) the code contains. Set lengths for Codabar to any length, one or two discrete lengths, or lengths within a specific range.

- One Discrete Length** - Select this option to decode only Codabar symbols containing a selected length. Select the length using the numeric bar codes in [Appendix D, Numeric Bar Codes](#). For example, to decode only Codabar symbols with 14 characters, scan **Codabar - One Discrete Length**, then scan **1** followed by **4**. To correct an error or to change the selection, scan [Cancel on page D-2](#).
- Two Discrete Lengths** - Select this option to decode only Codabar symbols containing either of two selected lengths. Select lengths using the numeric bar codes in [Appendix D, Numeric Bar Codes](#). For example, to decode only Codabar symbols containing either 2 or 14 characters, select **Codabar - Two Discrete Lengths**, then scan **0, 2, 1**, and then **4**. To correct an error or to change the selection, scan [Cancel on page D-2](#).
- Length Within Range** - Select this option to decode a Codabar symbol with a specific length range. Select lengths using numeric bar codes in [Appendix D, Numeric Bar Codes](#). For example, to decode Codabar symbols containing between 4 and 12 characters, first scan **Codabar - Length Within Range**. Then scan **0, 4, 1**, and **2** (enter a leading zero for single digit numbers). To correct an error or change the selection, scan [Cancel on page D-2](#).
- Any Length** - Scan this option to decode Codabar symbols containing any number of characters within the digital scanner's capability.

Set Lengths for Codabar (continued)



Codabar - One Discrete Length



Codabar - Two Discrete Lengths



Codabar - Length Within Range



Codabar - Any Length

CLSI Editing

Parameter # 36h

Enable this parameter to strip the start and stop characters and insert a space after the first, fifth, and tenth characters of a 14-character Codabar symbol. Enable this feature if the host system requires this data format.

✓ **NOTE** Symbol length does not include start and stop characters.

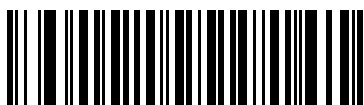

Enable CLSI Editing
(01h)

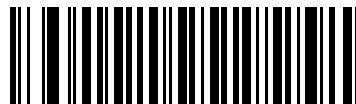

*Disable CLSI Editing
(00h)

NOTIS Editing

Parameter # 37h

Enable this parameter to strip the start and stop characters from a decoded Codabar symbol. Enable this feature if the host system requires this data format.

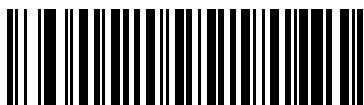

Enable NOTIS Editing
(01h)

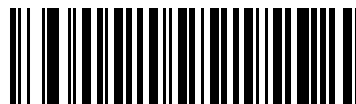

*Disable NOTIS Editing
(00h)

MSI

Enable/Disable MSI

Parameter # 0Bh

To enable or disable MSI, scan the appropriate bar code below.

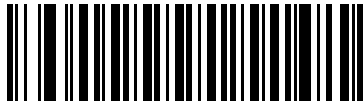

Enable MSI
(01h)

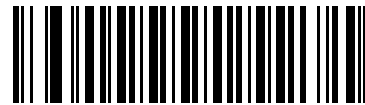

*Disable MSI
(00h)

Set Lengths for MSI

Parameter # L1 = 1Eh, L2 = 1Fh

The length of a code refers to the number of characters (i.e., human readable characters), including check digit(s) the code contains. Set lengths for MSI to any length, one or two discrete lengths, or lengths within a specific range.

- **One Discrete Length** - Select this option to decode only MSI symbols containing a selected length. Select the length using the numeric bar codes in [Appendix D, Numeric Bar Codes](#). For example, to decode only MSI symbols with 14 characters, scan **MSI - One Discrete Length**, then scan **1** followed by **4**. To correct an error or to change the selection, scan [Cancel on page D-2](#).
- **Two Discrete Lengths** - Select this option to decode only MSI symbols containing either of two selected lengths. Select lengths using the numeric bar codes in [Appendix D, Numeric Bar Codes](#). For example, to decode only MSI symbols containing either 2 or 14 characters, select **MSI - Two Discrete Lengths**, then scan **0**, **2**, **1**, and then **4**. To correct an error or to change the selection, scan [Cancel on page D-2](#).
- **Length Within Range** - Select this option to decode a MSI symbol with a specific length range. Select lengths using numeric bar codes in [Appendix D, Numeric Bar Codes](#). For example, to decode MSI symbols containing between 4 and 12 characters, first scan **MSI - Length Within Range**. Then scan **0**, **4**, **1**, and **2** (enter a leading zero for single digit numbers). To correct an error or change the selection, scan [Cancel on page D-2](#).
- **Any Length** - Scan this option to decode MSI symbols containing any number of characters within the digital scanner's capability.

Set Lengths for MSI (continued)

- ✓ **NOTE** Due to the construction of the MSI symbology, it is possible for a scan line covering only a portion of the code to transmit as a complete scan, yielding less data than is encoded in the bar code. To prevent this, select specific lengths (**MSI - One Discrete Length, Two Discrete Lengths**) for MSI applications.

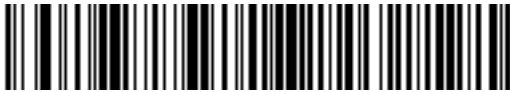

MSI - One Discrete Length



MSI - Two Discrete Lengths

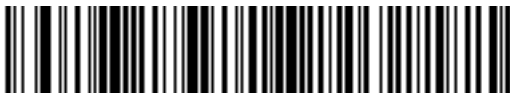

MSI - Length Within Range



MSI - Any Length

MSI Check Digits

Parameter # 32h

With MSI symbols, one check digit is mandatory and always verified by the reader. The second check digit is optional. If the MSI codes include two check digits, scan the **Two MSI Check Digits** bar code to enable verification of the second check digit.

See [MSI Check Digit Algorithm on page 6-53](#) for the selection of second digit algorithms.

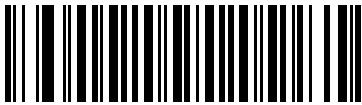

*One MSI Check Digit
(00h)

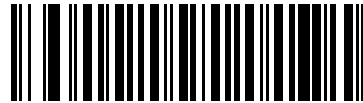

Two MSI Check Digits
(01h)

Transmit MSI Check Digit(s)

Parameter # 2Eh

Scan a bar code below to transmit MSI data with or without the check digit.

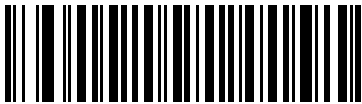

Transmit MSI Check Digit(s) (Enable)
(01h)

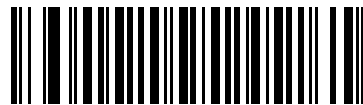

*Do Not Transmit MSI Check Digit(s) (Disable)
(00h)

MSI Check Digit Algorithm

Parameter # 33h

Two algorithms are possible for the verification of the second MSI check digit. Select the bar code below corresponding to the algorithm used to encode the check digit.



MOD 10/MOD 11
(00h)

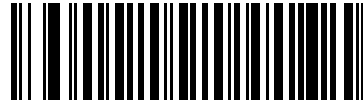

*MOD 10/MOD 10
(01h)

Chinese 2 of 5

Enable/Disable Chinese 2 of 5

Parameter # F0h 98h

To enable or disable Chinese 2 of 5, scan the appropriate bar code below.



Enable Chinese 2 of 5
(01h)

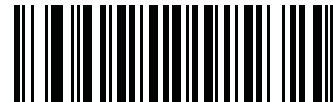

*Disable Chinese 2 of 5
(00h)

Matrix 2 of 5

Enable/Disable Matrix 2 of 5

Parameter # F1h 6Ah

To enable or disable Matrix 2 of 5, scan the appropriate bar code below.



Enable Matrix 2 of 5
(01h)

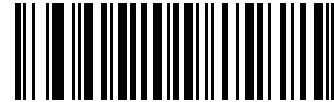

*Disable Matrix 2 of 5
(00h)

Set Lengths for Matrix 2 of 5

Parameter # L1 = F1h 6Bh, L2 = F1h 6Ch

The length of a code refers to the number of characters (i.e., human readable characters), including check digit(s) the code contains. Set lengths for Matrix 2 of 5 to any length, one or two discrete lengths, or lengths within a specific range.

- **One Discrete Length** - Select this option to decode only Matrix 2 of 5 symbols containing a selected length. Select the length using the numeric bar codes in [Appendix D, Numeric Bar Codes](#). For example, to decode only Matrix 2 of 5 symbols with 14 characters, scan **Matrix 2 of 5 - One Discrete Length**, then scan **1** followed by **4**. To correct an error or to change the selection, scan [Cancel on page D-2](#).
- **Two Discrete Lengths** - Select this option to decode only Matrix 2 of 5 symbols containing either of two selected lengths. Select lengths using the numeric bar codes in [Appendix D, Numeric Bar Codes](#). For example, to decode only Matrix 2 of 5 symbols containing either 2 or 14 characters, select **Matrix 2 of 5 - Two Discrete Lengths**, then scan **0, 2, 1**, and then **4**. To correct an error or to change the selection, scan [Cancel on page D-2](#).
- **Length Within Range** - Select this option to decode a Matrix 2 of 5 symbol with a specific length range. Select lengths using the numeric bar codes in [Appendix D, Numeric Bar Codes](#). For example, to decode Matrix 2 of 5 symbols containing between 4 and 12 characters, first scan **Matrix 2 of 5 - Length Within Range**. Then scan **0, 4, 1**, and **2** (enter a leading zero for single digit numbers). To correct an error or change the selection, scan [Cancel on page D-2](#).
- **Any Length** - Scan this option to decode Matrix 2 of 5 symbols containing any number of characters within the digital scanner's capability.

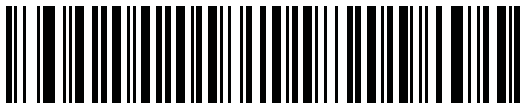

*Matrix 2 of 5 - One Discrete Length



Matrix 2 of 5 - Two Discrete Lengths

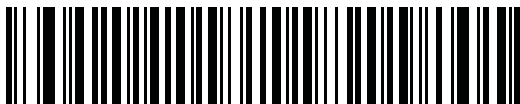

Matrix 2 of 5 - Length Within Range



Matrix 2 of 5 - Any Length

Matrix 2 of 5 Redundancy

Parameter # F1h 6Dh

To enable or disable Matrix 2 of 5 redundancy, scan the appropriate bar code below.



**Enable Matrix 2 of 5 Redundancy
(01h)**



***Disable Matrix 2 of 5 Redundancy
(00h)**

Matrix 2 of 5 Check Digit

Parameter # F1h 6Eh

The check digit is the last character of the symbol used to verify the integrity of the data. Scan the appropriate bar code below to transmit the bar code data with or without the Matrix 2 of 5 check digit.



**Enable Matrix 2 of 5 Check Digit
(01h)**



***Disable Matrix 2 of 5 Check Digit
(00h)**

Transmit Matrix 2 of 5 Check Digit

Parameter # F1h 6Fh

Scan a bar code below to transmit Matrix 2 of 5 data with or without the check digit.



Transmit Matrix 2 of 5 Check Digit
(01h)



*Do Not Transmit Matrix 2 of 5 Check Digit
(00h)

Inverse 1D

Parameter # F1h 4Ah

This parameter sets the 1D inverse decoder setting. Options are:

- **Regular Only** - the digital scanner decodes regular 1D bar codes only.
- **Inverse Only** - the digital scanner decodes inverse 1D bar codes only.
- **Inverse Autodetect** - the digital scanner decodes both regular and inverse 1D bar codes.



*Regular
(00h)



Inverse Only
(01h)



Inverse Autodetect
(02h)

Postal Codes

US Postnet

Parameter # 59h

To enable or disable US Postnet, scan the appropriate bar code below.



**Enable US Postnet
(01h)**



***Disable US Postnet
(00h)**

US Planet

Parameter # 5Ah

To enable or disable US Planet, scan the appropriate bar code below.



**Enable US Planet
(01h)**



***Disable US Planet
(00h)**

Transmit US Postal Check Digit

Parameter # 5Fh

Select whether to transmit US Postal data, which includes both US Postnet and US Planet, with or without the check digit.



***Transmit US Postal Check Digit
(01h)**

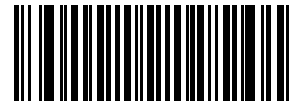

**Do Not Transmit US Postal Check Digit
(00h)**

UK Postal

Parameter # 5Bh

To enable or disable UK Postal, scan the appropriate bar code below.



**Enable UK Postal
(01h)**



***Disable UK Postal
(00h)**

Transmit UK Postal Check Digit

Parameter # 60h

Select whether to transmit UK Postal data with or without the check digit.



***Transmit UK Postal
Check Digit
(01h)**



**Do Not Transmit UK Postal Check Digit
(00h)**

Japan Postal

Parameter # F0h, 22h

To enable or disable Japan Postal, scan the appropriate bar code below.



**Enable Japan Postal
(01h)**



***Disable Japan Postal
(00h)**

Australian Postal

Parameter # F0h, 23h

To enable or disable Australian Postal, scan the appropriate bar code below.



**Enable Australian Postal
(01h)**



***Disable Australian Postal
(00h)**

Netherlands KIX Code

Parameter # F0h, 46h

To enable or disable Netherlands KIX Code, scan the appropriate bar code below.



**Enable Netherlands KIX Code
(01h)**



***Disable Netherlands KIX Code
(00h)**

USPS 4CB/One Code/Intelligent Mail

Parameter # F1h 50h

To enable or disable USPS 4CB/One Code/Intelligent Mail, scan the appropriate bar code below.



**Enable USPS 4CB/One Code/Intelligent Mail
(01h)**



***Disable USPS 4CB/One Code/Intelligent Mail
(00h)**

UPU FICS Postal

Parameter # F1h 63h

To enable or disable UPU FICS Postal, scan the appropriate bar code below.

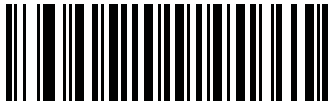

**Enable UPU FICS Postal
(01h)**

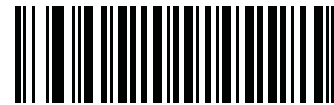

***Disable UPU FICS Postal
(00h)**

GS1 DataBar

The variants of GS1 DataBar are DataBar-14, DataBar Expanded, and DataBar Limited. The limited and expanded versions have stacked variants. Scan the appropriate bar codes to enable or disable each variant of GS1 DataBar.

GS1 DataBar-14

Parameter # F0h 52h.

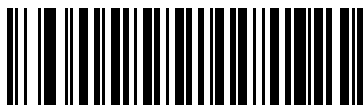

Enable GS1 DataBar-14
(01h)

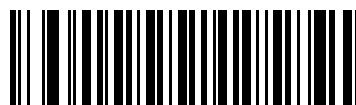

*Disable GS1 DataBar 14
(00h)

GS1 DataBar Limited

Parameter # F0h 53h.

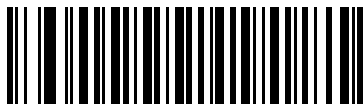

Enable GS1 DataBar Limited
(01h)

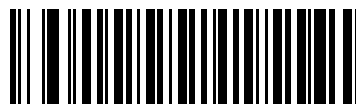

*Disable GS1 DataBar Limited
(00h)

GS1 DataBar Expanded

Parameter # F0h 54h.

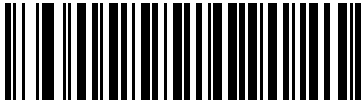

**Enable GS1 DataBar Expanded
(01h)**

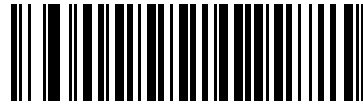

***Disable GS1 DataBar Expanded
(00h)**

Convert GS1 DataBar to UPC/EAN

Parameter # F0h, 8Dh

This parameter only applies to GS1 DataBar-14 and GS1 DataBar Limited symbols not decoded as part of a Composite symbol. Enable this to strip the leading '010' from DataBar-14 and DataBar Limited symbols encoding a single zero as the first digit, and report the bar code as EAN-13.

For bar codes beginning with two or more zeros but not six zeros, this parameter strips the leading '0100' and reports the bar code as UPC-A. The UPC-A Preamble parameter that transmits the system character and country code applies to converted bar codes. Note that neither the system character nor the check digit can be stripped.

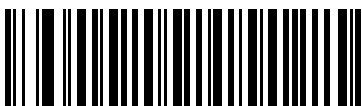

**Enable Convert GS1 DataBar to UPC/EAN
(01h)**

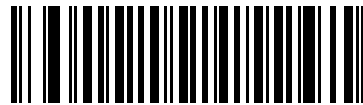

***Disable Convert GS1 DataBar to UPC/EAN
(00h)**

Composite

Composite CC-C

Parameter # F0h 55h

Scan a bar code below to enable or disable Composite bar codes of type CC-C.

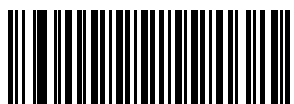

Enable CC-C
(01h)



*Disable CC-C
(00h)

Composite CC-A/B

Parameter # F0h 56h

Scan a bar code below to enable or disable Composite bar codes of type CC-A/B.



Enable CC-A/B
(01h)



*Disable CC-A/B
(00h)

Composite TLC-39

Parameter # F0h 73h

Scan a bar code below to enable or disable Composite bar codes of type TLC-39.

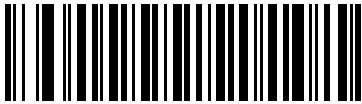

Enable TLC39
(01h)



*Disable TLC39
(00h)

UPC Composite Mode

Parameter # F0h 58h

Select an option for linking UPC symbols with a 2D symbol during transmission as if they were one symbol:

- Select **UPC Never Linked** to transmit UPC bar codes regardless of whether a 2D symbol is detected.
- Select **UPC Always Linked** to transmit UPC bar codes and the 2D portion. If 2D is not present, the UPC bar code does not transmit.
- If you select **Autodiscriminate UPC Composites**, the digital scanner determines if there is a 2D portion, then transmits the UPC, as well as the 2D portion if present.



*UPC Never Linked
(00h)



UPC Always Linked
(01h)



Autodiscriminate UPC Composites
(02h)

Composite Beep Mode

Parameter # F0h, 8Eh

To select the number of decode beeps when a composite bar code is decoded, scan the appropriate bar code.

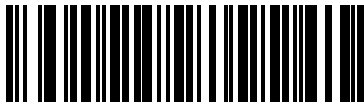

Single Beep after both are decoded
(00h)

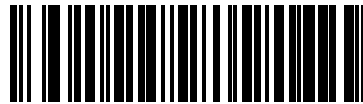

*Beep as each code type is decoded
(01h)

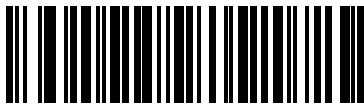

Double Beep after both are decoded
(02h)

GS1-128 Emulation Mode for UCC/EAN Composite Codes

Parameter # F0h, ABh

Select whether to enable or disable this mode.



Enable GS1-128 Emulation Mode for
UCC/EAN Composite Codes
(01h)



*Disable GS1-128 Emulation Mode for
UCC/EAN Composite Codes
(00h)

2D Symbologies

Enable/Disable PDF417

Parameter # 0Fh

To enable or disable PDF417, scan the appropriate bar code below.



***Enable PDF417
(01h)**



**Disable PDF417
(00h)**

Enable/Disable MicroPDF417

Parameter # E3h

To enable or disable MicroPDF417, scan the appropriate bar code below.



**Enable MicroPDF417
(01h)**



***Disable MicroPDF417
(00h)**

Code 128 Emulation

Parameter # 7Bh

Enable this parameter to transmit data from certain MicroPDF417 symbols as Code 128. [AIM Code ID Character \(01h\) on page 5-16](#) must be enabled for this parameter to work.

Enable Code 128 Emulation to transmit these MicroPDF417 symbols with one of the following prefixes:

-]C1if the first codeword is 903-905
-]C2if the first codeword is 908 or 909
-]C0if the first codeword is 910 or 911

Disable Code 128 Emulation to transmit these MicroPDF417 symbols with one of the following prefixes:

-]L3if the first codeword is 903-905
-]L4if the first codeword is 908 or 909
-]L5if the first codeword is 910 or 911

Scan a bar code below to enable or disable Code 128 Emulation.



NOTE Linked MicroPDF codewords 906, 907, 912, 914, and 915 are not supported. Use GS1 Composites instead.



**Enable Code 128 Emulation
(01h)**



***Disable Code 128 Emulation
(00h)**

Data Matrix

Parameter # F0h, 24h

To enable or disable Data Matrix, scan the appropriate bar code below.



***Enable Data Matrix
(01h)**



**Disable Data Matrix
(00h)**

Data Matrix Inverse

Parameter # F1h 4Ch

This parameter sets the Data Matrix inverse decoder setting. Options are:

- **Regular Only** - the digital scanner decodes regular Data Matrix bar codes only.
- **Inverse Only** - the digital scanner decodes inverse Data Matrix bar codes only.
- **Inverse Autodetect** - the digital scanner decodes both regular and inverse Data Matrix bar codes.



***Regular
(00h)**



**Inverse Only
(01h)**



**Inverse Autodetect
(02h)**

Maxicode

Parameter # F0h, 26h

To enable or disable Maxicode, scan the appropriate bar code below.



**Enable Maxicode
(01h)**



***Disable Maxicode
(00h)**

QR Code

Parameter # F0h, 25h

To enable or disable QR Code, scan the appropriate bar code below.



***Enable QR Code
(01h)**



**Disable QR Code
(00h)**

QR Inverse

Parameter # F1h 4Bh

This parameter sets the QR inverse decoder setting. Options are:

- **Regular Only** - the digital scanner decodes regular QR bar codes only.
- **Inverse Only** - the digital scanner decodes inverse QR bar codes only.
- **Inverse Autodetect** - the digital scanner decodes both regular and inverse QR bar codes.



*Regular
(00h)



Inverse Only
(01h)



Inverse Autodetect
(02h)

MicroQR

Parameter # F1h 3Dh

To enable or disable MicroQR, scan the appropriate bar code below.



*Enable MicroQR
(01h)



Disable MicroQR
(00h)

Aztec

Parameter # F1h 3Eh

To enable or disable Aztec, scan the appropriate bar code below.



*Enable Aztec
(01h)



Disable Aztec
(00h)

Aztec Inverse

Parameter # F1h 4Dh

This parameter sets the Aztec inverse decoder setting. Options are:

- **Regular Only** - the digital scanner decodes regular Aztec bar codes only.
- **Inverse Only** - the digital scanner decodes inverse Aztec bar codes only.
- **Inverse Autodetect** - the digital scanner decodes both regular and inverse Aztec bar codes.



*Regular
(00h)



Inverse Only
(01h)



Inverse Autodetect
(02h)

Redundancy Level

Parameter # 4Eh

The digital scanner offers four levels of decode redundancy. Select higher redundancy levels for decreasing levels of bar code quality. As redundancy levels increase, the digital scanner's aggressiveness decreases.

Select the redundancy level appropriate for the bar code quality.

Redundancy Level 1

The following code types must be successfully read twice before being decoded:

Table 6-2 *Redundancy Level 1 Codes*

Code Type	Code Length
Codabar	8 characters or less
MSI	4 characters or less
D 2 of 5	8 characters or less
I 2 of 5	8 characters or less

Redundancy Level 2

The following code types must be successfully read twice before being decoded:

Table 6-3 *Redundancy Level 2 Codes*

Code Type	Code Length
All	All

Redundancy Level 3

Code types other than the following must be successfully read twice before being decoded. The following codes must be read three times:

Table 6-4 *Redundancy Level 3 Codes*

Code Type	Code Length
MSI	4 characters or less
D 2 of 5	8 characters or less
I 2 of 5	8 characters or less
Codabar	8 characters or less

Redundancy Level 4

The following code types must be successfully read three times before being decoded:

Table 6-5 *Redundancy Level 4 Codes*

Code Type	Code Length
All	All

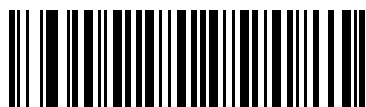

*Redundancy Level 1
(01h)



Redundancy Level 2
(02h)



Redundancy Level 3
(03h)

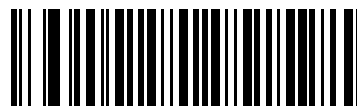

Redundancy Level 4
(04h)

Security Level

Parameter # 4Dh

The digital scanner offers four levels of decode security for delta bar codes, which include the Code 128 family, UPC/EAN, and Code 93. Select increasing levels of security for decreasing levels of bar code quality. There is an inverse relationship between security and digital scanner aggressiveness, so choose only that level of security necessary for any given application.

- **Security Level 0:** This setting allows the digital scanner to operate in its most aggressive state, while providing sufficient security in decoding most “in-spec” bar codes.
- **Security Level 1:** This default setting eliminates most misdecodes.
- **Security Level 2:** Select this option if Security level 1 fails to eliminate misdecodes.
- **Security Level 3:** If you selected Security Level 2 and misdecodes still occur, select this security level. Be advised, selecting this option is an extreme measure against mis-decoding severely out of spec bar codes. Selecting this level of security significantly impairs the decoding ability of the digital scanner. If you need this level of security, try to improve the quality of the bar codes.

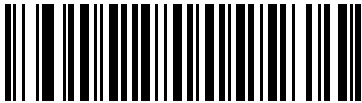

*Security Level 0
(00h)



Security Level 1
(01h)



Security Level 2
(02h)



Security Level 3
(03h)

Intercharacter Gap Size

Parameter # F0h, 7Dh

The Code 39 and Codabar symbologies have an intercharacter gap that is typically quite small. Due to various bar code-printing technologies, this gap can grow larger than the maximum size allowed, preventing the digital scanner from decoding the symbol. If this problem occurs, scan the **Large Intercharacter Gaps** parameter to tolerate these out-of-specification bar codes.



***Normal Intercharacter Gaps
(06h)**



**Large Intercharacter Gaps
(0Ah)**

Report Version

Scan the bar code below to report the version of software installed in the digital scanner.



Report Software Version

Macro PDF Features

Macro PDF is a special feature for concatenating multiple PDF symbols into one file. The scanner can decode symbols that are encoded with this feature, and can store more than 64 Kb of decoded data stored in up to 50 MacroPDF symbols.



CAUTION When printing, keep each Macro PDF sequence separate, as each sequence has unique identifiers. Do not mix bar codes from several Macro PDF sequences, even if they encode the same data. When scanning Macro PDF sequences, scan the entire Macro PDF sequence without interruption. If, when scanning a mixed sequence, the digital scanner emits two long low beeps (Low/Low) this indicates an inconsistent file ID or inconsistent symbology error.

Flush Macro Buffer

This flushes the buffer of all decoded Macro PDF data stored to that point, transmits it to the host device, and aborts from Macro PDF mode.

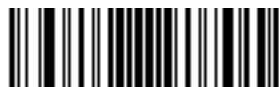

Flush Macro PDF Buffer

Abort Macro PDF Entry

This clears all currently-stored Macro PDF data in the buffer without transmission and aborts from Macro PDF mode.



Abort Macro PDF Entry

Chapter 7 RS507 Bluetooth Connection Using HID and SPP Profiles

Introduction

The RS507 is designed to connect over Bluetooth (BT) and also operate hand in hand with a personal computer or non-Motorola terminals. This chapter describes the Bluetooth connection modes of the RS507 to a personal computer and non-Motorola terminals.

This chapter includes the following sections:

- [RS507 to Computer Bluetooth Connection Modes on page 7-1](#)
- [RS507 Important hardware features on page 7-2](#)
- [Refreshing Boot Choices on page 7-3](#)
- [HID \(Human Interface Device\) Mode on page 7-3](#)
- [Serial Port Profile \(SPP\) Mode on page 7-18](#)
- [Firmware upgrade on page 7-38](#)
- [Retrieving the RS507 log file on page 7-43](#)
- [Bluetooth Bar Codes on page 7-47](#)

RS507 to Computer Bluetooth Connection Modes

The RS507 can connect to a computer over Bluetooth (BT) using the Serial Port Profile (SPP) or Human Interface Device (HID) BT modes.

SSI (SCAN) Mode

SSI Simple Serial Interface (SCAN) is the default mode before changing to operate in SPP or HID Bluetooth mode.

SSI (SCAN) mode is also used when the RS507 is connected to a Motorola MPA-based mobile terminal or when using the PC Tool application ([Upgrading using a computer and the PC Tool application on page 7-38](#)).

Serial Port Profile (SPP) Mode

The SPP mode is used when the RS507 is connected to a computer as serial device.

The data of the scanned bar codes is transferred directly to the serial port of the computer. The scanned data can be edited by a wedge application.

Human Interface Device (HID) Mode

In HID mode, the RS507 is connected over BT to a computer as a keyboard device. The computer decodes the emulated key strokes sent by the RS507. The scanned data can be received by any Windows application that accepts keyboard data.

The scanned data can also be processed to suit particular requirements before transmitted to a computer application using Advanced Data Formatting (ADF). For information and programming bar codes for ADF, refer to the Advanced Data Formatting Programmer Guide, p/n 72E-69680-xx (refer only to the programming bar codes that relate to bar code imagers, not Laser bar code scanners).

RS507 Important hardware features

The following figure shows important hardware features of the RS507 referred to in this section.

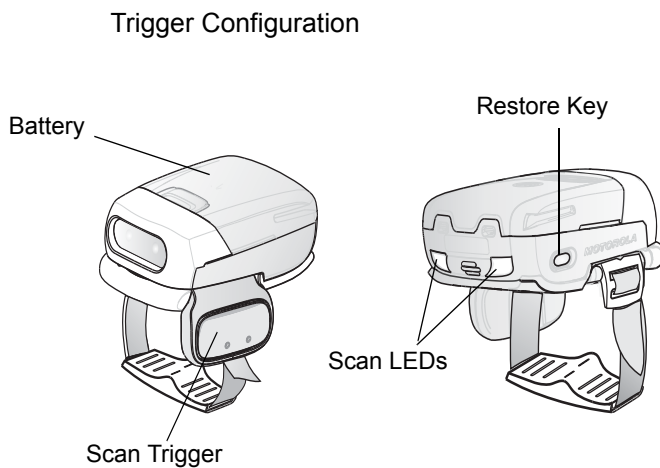

Triggerless Configuration

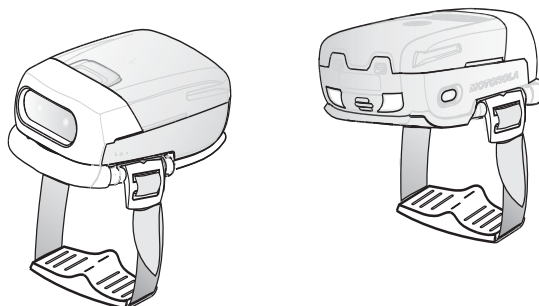

Figure 7-1 RS507 Important hardware features

Refreshing Boot Choices

The following boot choices are referred to in this section:

Cold Boot

Cold Boot restores the RS507 operation by resetting its software. To perform a cold boot, remove and re-insert the battery onto the RS507.

Clean Boot

Clean Boot restores the RS507 to its factory default configuration.

To perform Clean Boot:

1. Remove the battery from the RS507.
2. Press and hold the Restore Key.
3. Insert the Battery onto the RS507.
4. Keep holding the Restore Key pressed for about five seconds until a chirp is heard and the Scan LEDs flash green. The RS507 is now in its factory default configuration.

Warm Boot

Warm boot restores the RS507 operation by resetting its software but retains the RAM content. Warm boot is used when a log file has to be retrieved from the RS507 during application debugging.

To perform warm boot, press and hold the Restore Key for more than six seconds.

HID (Human Interface Device) Mode

✓ **NOTE** Notebook computer manufacturers may provide their own brand of a BT stack with different connection screens. However, all stacks provide the same functionality.

How to change to HID mode

1. Perform Clean Boot to the RS507:
 - Remove the battery from the RS507.
 - Press and hold the Restore key.
 - Install the battery onto the RS507.
 - Keep holding the **Restore key** pressed for about five seconds until a chirp is heard and the **Scan LEDs** flash green.
2. Scan the HID bar code.

HID bar code



3. Perform a Cold Boot by removing and re-installing the battery onto the RS507. The RS507 starts to operate and is discoverable as a keyboard.

How to format the scanned data

Advanced Data Formatting (ADF)

The scanned bar code data can be processed and formatted before the RS507 sends it to an application. For Motorola Advanced Data Formatting. For information and programming bar codes for ADF, refer to the Advanced Data Formatting Programmer Guide, p/n 72E-69680-xx (refer only to the programming bar codes that relate to bar code imagers, not Laser bar code scanners).

How to pair and connect with a computer running Windows 7 SP1

- ✓ **NOTES**
- For best user experience, it is recommend using Secure Simple Pairing (SSP). Windows 7 SP1 supports BT 2.1 and as such, supports SSP.
 - SSP reduces the number of steps to minimal or none when compared to legacy BT pairing.
 - If the computer does not include an integrated BT module, a USB BT dongle can be used.
 - Use off-the-shelf dongle that supports BT v2.1 for effortless pairing in SSP.

To pair and connect the RS507:

1. Right click on BT icon and select **Open Setting > Add a Device**.

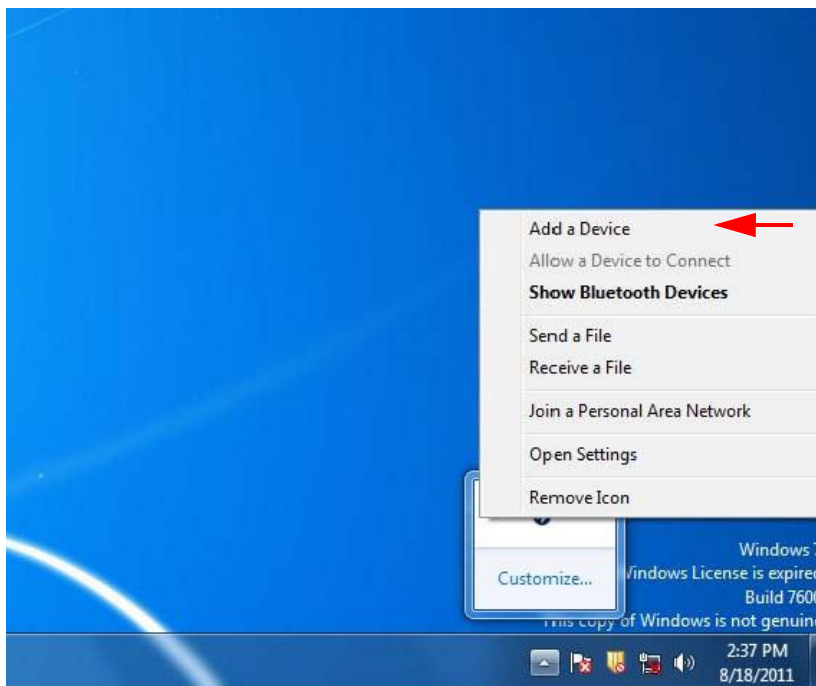

Figure 7-2 HID - Open Setting Screen - Windows 7 SP1

2. From the **Add a device** screen, select the RS507 (shown as *Bluetooth Keyboard*) and click **Next**.

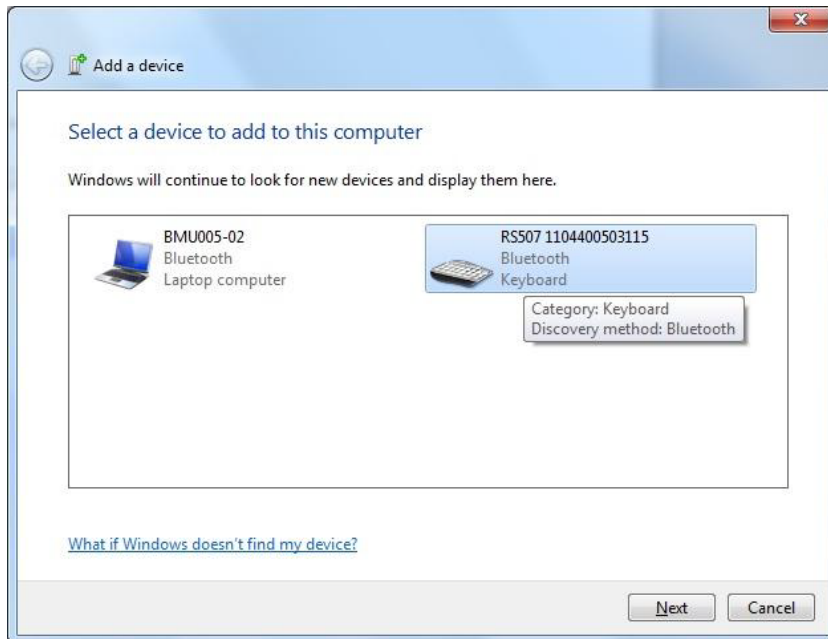

Figure 7-3 HID - Add Device Screen - Windows 7 SP1

The computer connects to the RS507 and the following screen is displayed.

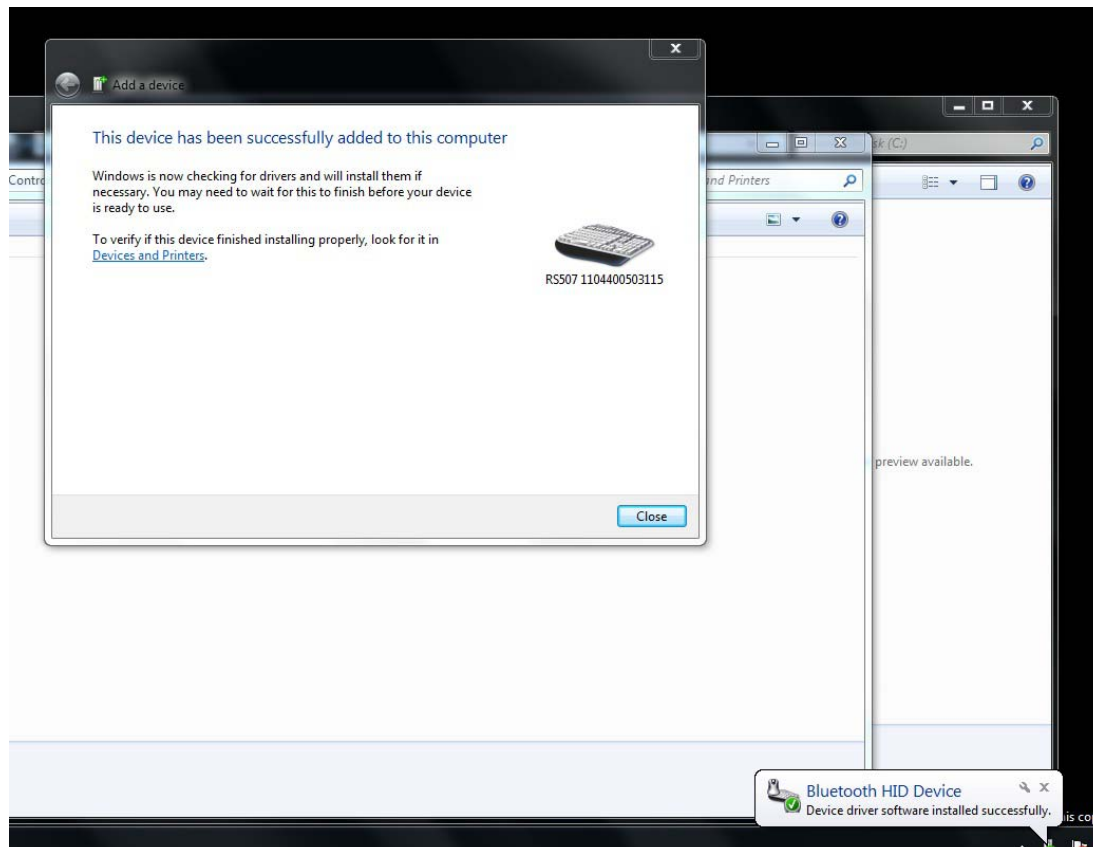

Figure 7-4 HID - Device Successfully Added Screen - Windows 7SP1

How to pair and connect with a computer running Windows XP SP3 and Bluetooth 2.1

For best user experience it is recommended to use Secure Simple Pairing (SSP) that is supported in BT V2.1. SSP reduces the number of steps to minimal or none when compared to legacy BT pairing.

To pair and connect with a computer:

1. Verifying that Windows XP Service Pack 3 (SP3) is installed.
2. Since Windows XP does not support BT V2.1, load new BT stack that supports BT V2.1 by either:
3. Following the instructions on the Broadcom site at: <http://www.broadcom.com/support/bluetooth/update.php> and install the WIDCOMM stack.
4. Purchasing an off-the-shelf USB Bluetooth dongle that supports BT V2.1 and installing the provided BT V2.1 drivers. Using USB Bluetooth dongle is the only option if the computer does not include an integrated BT module. When using earlier BT versions, you will need to enter passkey **12345** or disable authentication by scanning:

Disable Authentication bar code



Pair and connect the RS507 as follows:

1. Right click the BT icon on the computer desktop tray.



Figure 7-5 HID - BT Icon On Computer Desktop Tray - Windows XP SP3 and Bluetooth V2.1

Or

From My Bluetooth Places > Bluetooth Tasks bar, select Add a Bluetooth Device.

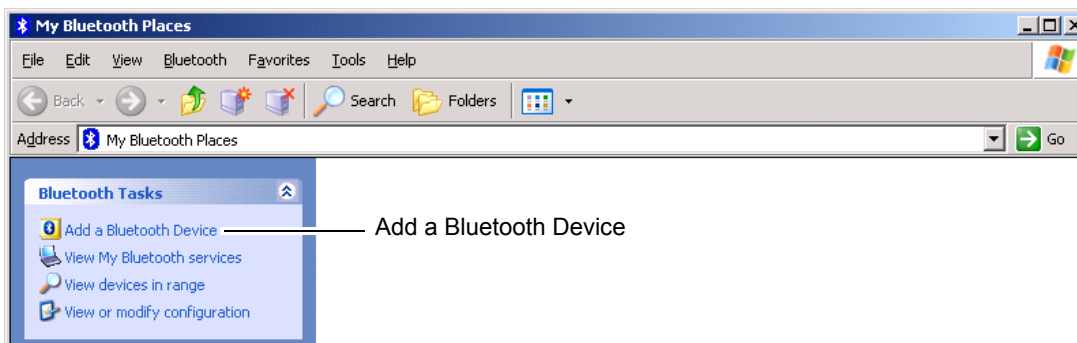

Figure 7-6 HID - My Bluetooth Places Screen - Windows XP SP3 and Bluetooth V2.1

2. Check the *My device set up and ready to be found* box and click **Next**.

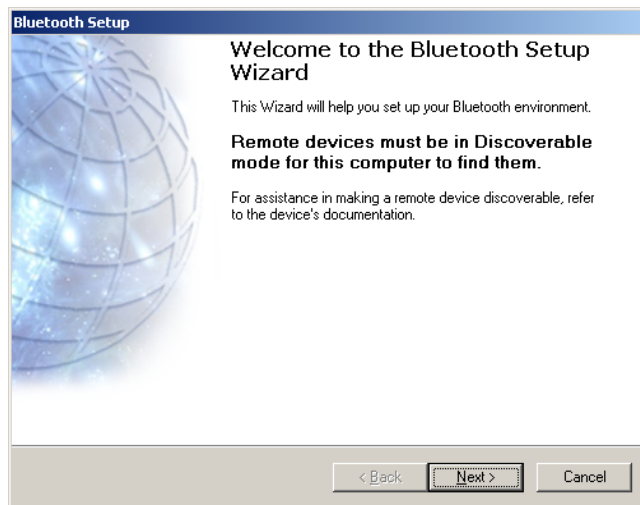

Figure 7-7 HID - Bluetooth Setup Screen - Windows XP SP3 and Bluetooth V2.1

3. Verify that the RS507 is found by the Host in the **Bluetooth Device Selection** screen. Select the RS507 and click **Next** to start the SSP process.

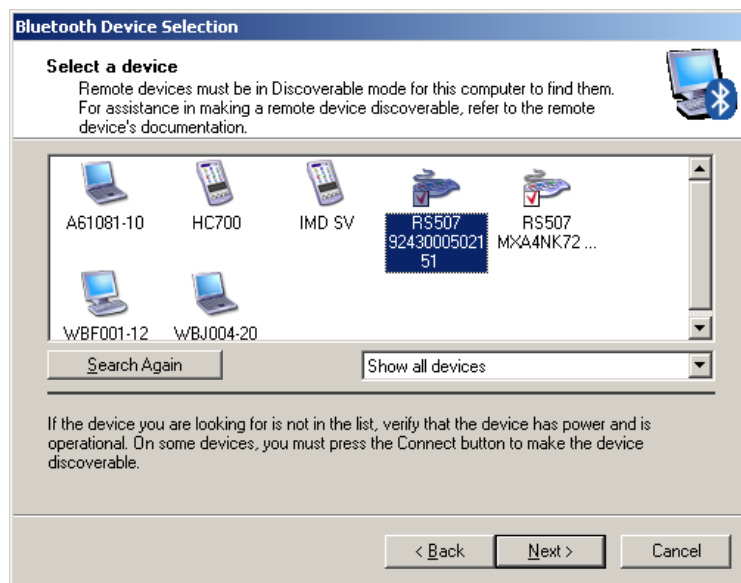

Figure 7-8 HID - Bluetooth Device Selection Screen - Windows XP SP3 and Bluetooth V2.1

The Secure Simple Pairing starts.

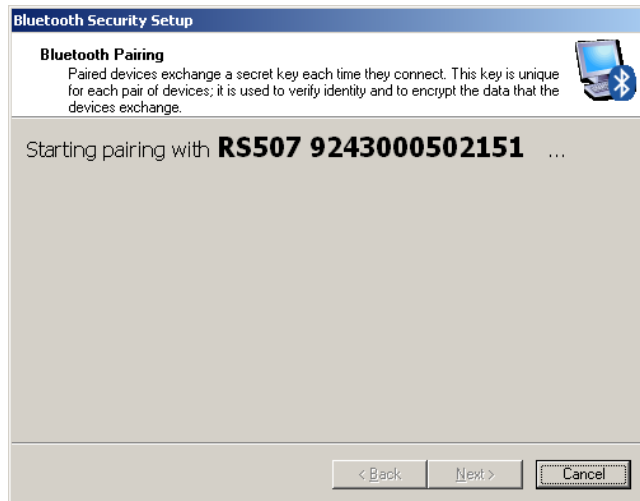

Figure 7-9 HID - Bluetooth Security Setup Screen - Windows XP SP3 and Bluetooth V2.1

If earlier BT stack is used (not equipped with SSP), check the **Let me choose my own passkey** button, enter **12345** (or scan the Disable BT Authentication bar code) and click **Next**. The pairing process completes and the RS507 connects without any further intervention.

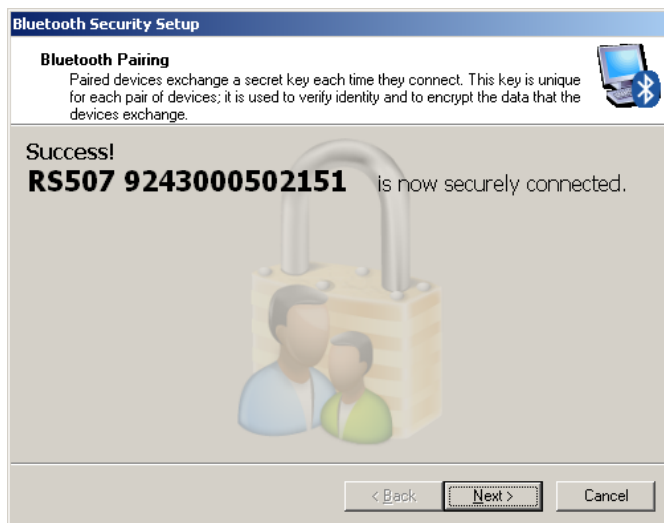

Figure 7-10 HID - Bluetooth Pairing Success Screen - Windows XP SP3 and Bluetooth V2.1

Upon successful BT pairing, the BT icon in the computer desktop tray turns green.



Figure 7-11 HID - BT Icon In Computer Desktop Tray - Windows 7SP1

✓ **NOTE** The next time you explore the **Bluetooth Devices Selection** screen, the RS507 will show connected.

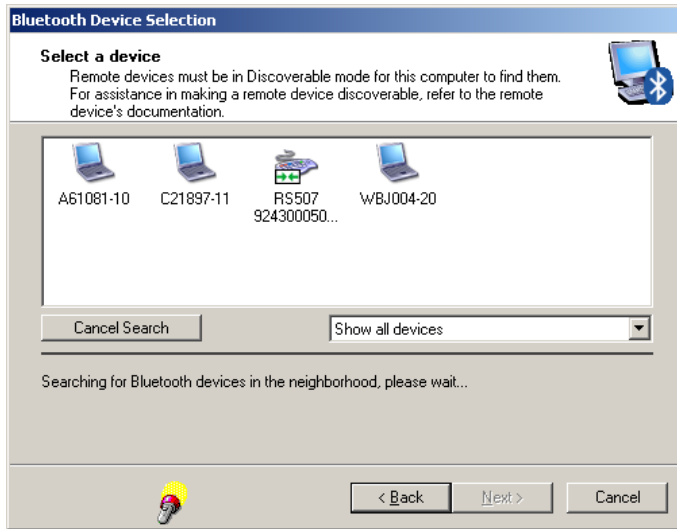

Figure 7-12 HID - Select a device Screen - Windows XP SP3 and Bluetooth V2.1

- If pairing results in an error, remove the RS507 from the BT stack by selecting it on the **My Bluetooth Places \ Entire Bluetooth Neighborhood** screen, right click and select **Disable**.

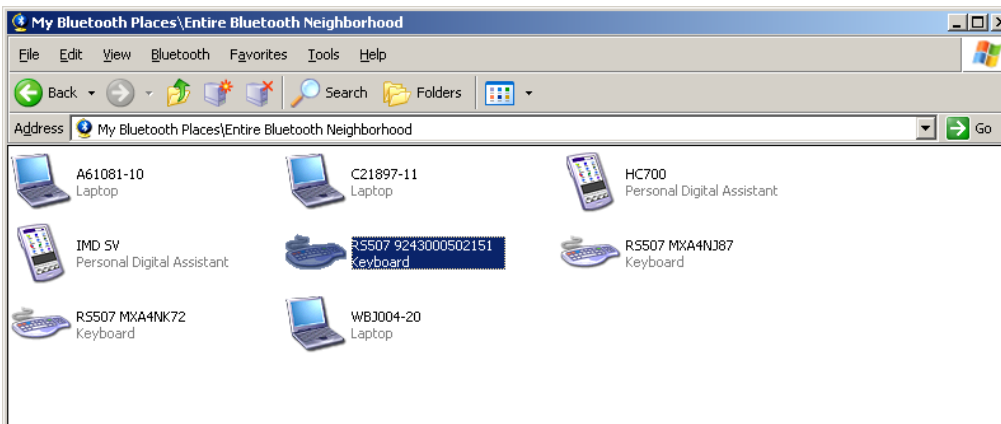

Figure 7-13 HID - Entire Bluetooth Neighborhood Screen - Windows XP SP3 and Bluetooth V2.1

- Scan the Un-Pairing bar code.

Un-pairing bar code



- The RS507 emits one string of high/low beeps indicating that BT communication with the PC is removed.
- If that does not help, perform Clean Boot (see [Clean Boot on page 7-3](#)) the RS507 and start the BT pairing again.

How to pair and connect with other devices

The RS507 can pair and connect as an emulated keyboard using the Bluetooth HID profile to other devices that support HID using the device discovery feature.

✓ **NOTE** Not all devices support HID. If the RS507 is not discovered as a keyboard (when it is in HID mode), consult the device information.

Reconnecting

Automatic reconnection

The RS507 maintains BT communication with the connected device within a range of 10 meters (30 feet).

When the RS507 fails to establish connection or connection is lost during operation:

1. The RS507 emits one string of low/high beeps.
2. The RS507 automatically attempts to reconnect to the computer for 30 seconds (the Scan LEDs flash green).

Manual reconnection to Restore Lost Bluetooth Connection

If automatic re-connection fails, verify that the RS507 is within BT range and briefly press the small Restore key on the side of the RS507 to reconnect.

1. The RS507 Scan LEDs start to flash green, indicating that the RS507 is attempting to establish connection with the computer.
2. The Scan LEDs turn off and the RS507 emits one string of low/high beeps indicating that the RS507 is connected and ready for scanning.

✓ **NOTE** When the RS507 is in HID connection mode, pressing the **Restore key** after any RS507 boot reconnects the RS507 to the last paired device. Connection is established as long as the link key (the authentication key used to establish a link between devices) on the RS507 side is not deleted.

How to demonstrate HID connection with a computer

Following a successful connection, data can be scanned into any Windows application field that accepts keyboard data; for example, the Notepad application.

To scan a bar code:

1. Run the Notepad application.
2. Scan a bar code. The scanned bar code information is displayed on the Notepad window.

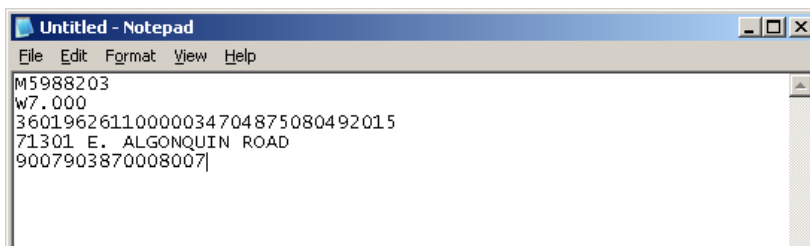

Figure 7-14 HID - Scanned Bar Code Information On Notepad Window

Country keyboard type change

While in HID mode, the RS507 supports several keyboard layouts.

To change the North American Standard Keyboards layout (see bar code marked by * below) to a different country code layout, scan the required bar code corresponding to the country keyboard type.



*North American Standard Keyboards



French Windows



German Windows



French Canadian Windows 98



Spanish Windows



Italian Windows



Swedish Windows



UK English Windows



Japanese Windows



French Canadian Windows 2000/XP



Portuguese/Brazilian Windows

Connecting multiple RS507 into single device

Multiple RS507 devices can concurrently connect to one device application.

In HID connection mode, all RS507 devices enter their virtual key strokes into the same data field of the device application.

Using random PIN code

To establish a BT connection with a computer using a random PIN code:

1. Scan the bar code of the Variable PIN code.

Variable PIN Code bar code



2. On the **Windows Explorer** screen, click the **My Bluetooth Places** icon.
3. From the **Bluetooth Tasks** bar, click on **Add a Bluetooth Device** to start the **Bluetooth Setup** wizard.

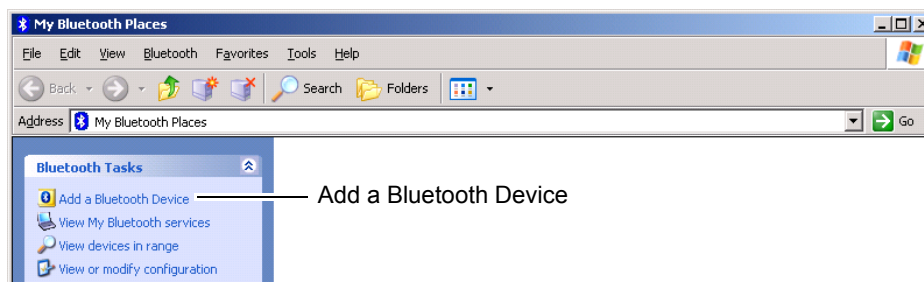

Figure 7-15 HID - Using Random PIN Code - My Bluetooth Places Screen

4. On **Bluetooth Setup** screen, click the **Next** button.

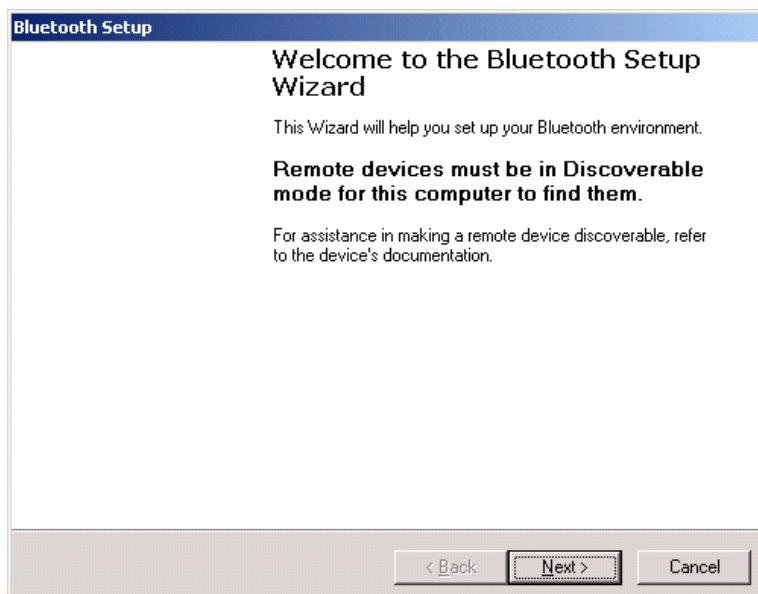

Figure 7-16 Using Random PIN Code - Bluetooth Setup Wizard Screen

5. On the **Bluetooth Device Selection** screen, select the RS507 displayed as a keyboard icon (MXA4NH80 is the serial number of the RS507) and click the **Next** button.

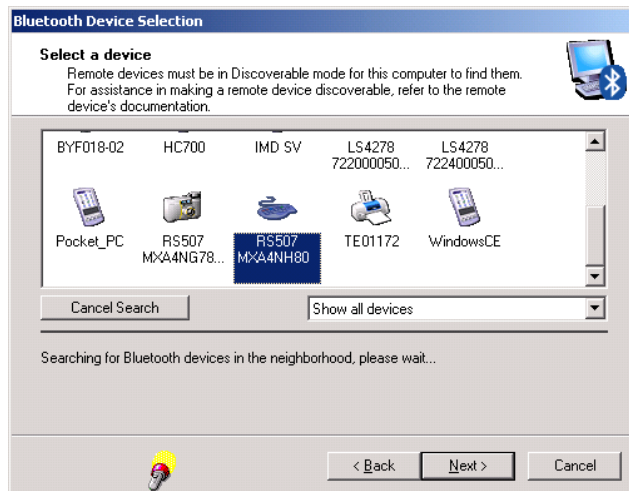

Figure 7-17 HID - Using Random PIN Code - Bluetooth Device Selection Screen

The RS507 beeps once indicating that it is waiting for an alphanumeric passkey entry.

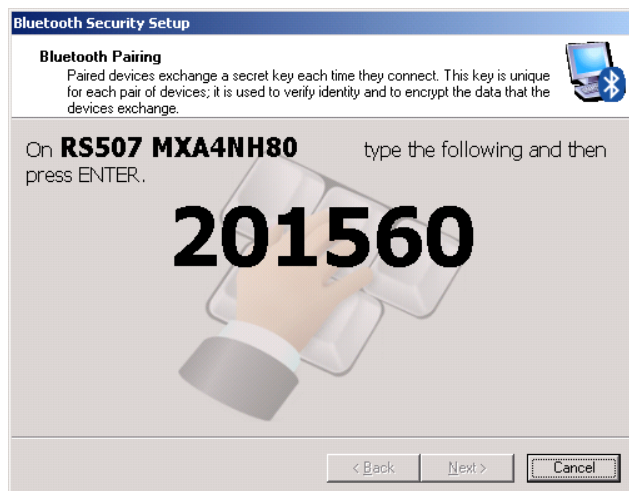

Figure 7-18 HID - Using Random PIN Code - Bluetooth Security / Alphanumeric Passkey Entry Screen

6. Enter the provided passkey by scanning the alphanumeric bar codes shown below.

Alphanumeric Keyboard Bar Codes

0



1



2



3



4



5



6



7



8



9



CANCEL



- Scan the End of Message bar code if the PIN code has less than 16 characters.

End of Message bar code



The RS507 emits a short high beep while scanning the alphanumeric bar codes and a high/low/high/low upon scanning the End of Message bar code. When the passkey is scanned successfully, *Success!* is displayed on the **Bluetooth Security Setup** screen.

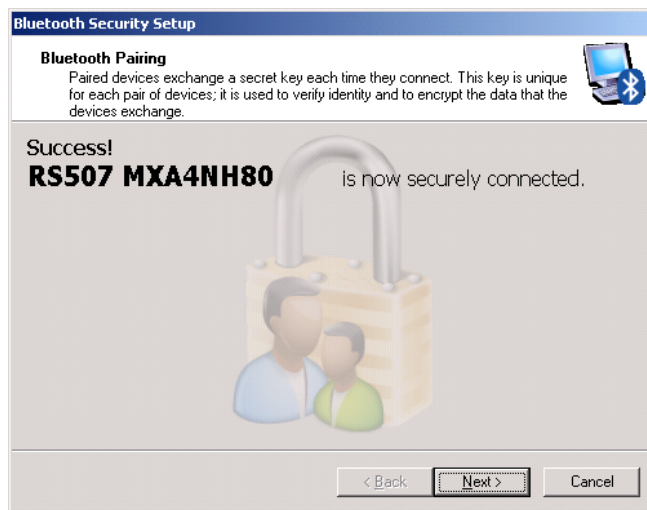

Figure 7-19 HID - Using Random PIN Code - Bluetooth Security Screen / Passkey Scanned Successfully

- Click **Next** to complete the association. The RS507 emits a short string of low/high beeps to indicate a successful pairing. When the connection is completed, the color of the BT icon on the quick launch bar of the PC is blue and green.



Figure 7-20 HID - Using Random PIN Code - Successful Pairing BT Icon

How to return to SSI (SCAN) mode

To return to SSI mode so that connection to Motorola terminals can be established, perform the following:

- Perform Clean Boot to the RS507:
 - Remove the battery from the RS507.
 - Press and hold the Restore key.
 - Install the Battery onto the RS507.

- Keep holding the Restore key pressed for about five seconds until a chirp is heard and the **Scan LEDs** flash green.
2. Scan the SSI (SCAN) bar code..

✓ **NOTE** The SCAN (SCAN) bar code can also be scanned directly from a computer screen.

SSI (SCAN) bar code



3. Perform a Cold Boot by removing and re-installing the battery onto the RS507 (see [Cold Boot on page 7-3](#)). The RS507 starts to operate using SSI (SCAN) mode.

Serial Port Profile (SPP) Mode

The RS507 can connect to a computer or other device that supports Bluetooth SPP interface as either a Master (the RS507 initiate the connection) or a Slave (the computer or other device initiate the connection and the RS507 is discovered by the computer).

- ✓ **NOTE** Notebook computer manufacturers may provide their own brand of a BT stack with different connection screens. However, all stacks provide the same functionality.

How to change to SPP mode

- ✓ **NOTE** - Since the SPP connection does not support automatic acknowledgement when the data is received by the computer application, a BELL indication is used. The BELL indication allows the computer application to send single binary character 0x07 to the RS507 (as defined in ASCII table). Upon receiving the BELL character, the RS507 beeps. To configure the beep, see [BELL Indication \(SPP mode only\) on page 7-49](#).

To change the RS507 to SPP mode:

1. Perform Clean Boot to the RS507 (see [Clean Boot on page 7-3](#)):
 - Remove the battery from the RS507.
 - Press and hold the Restore key.
 - Install the Battery onto the RS507.
 - Keep holding the Restore key pressed for about five seconds until a chirp is heard and the **Scan LEDs** flash green.
2. Scan SPP bar code.

SPP bar code



3. Perform a Cold Boot by removing and re-installing the battery onto the RS507. The RS507 starts to operate and is discoverable as a BT serial device (like a camera).

How to format the scanned data the data

Advanced Data Formatting (ADF)

The scanned bar code data can be processed and formatted before the RS507 sends it to an application using Advanced Data Formatting (ADF).

For information and programming bar codes for ADF, refer to the Advanced Data Formatting Programmer Guide, p/n 72E-69680-xx (refer only to the programming bar codes that relate to bar code imagers, not Laser bar code scanners).

Wedge

The scanned bar code data can also be processed and formatted before the RS507 send it to the application by using a 3rd party data wedge application. Such wedge applications are available for free download from 3rd party providers sites.

How to pair and connect with a computer running Windows 7 SP1

SPP connection with RS507 as a Master

1. Right click on the BT icon and select **Open Setting** to add a COM port.

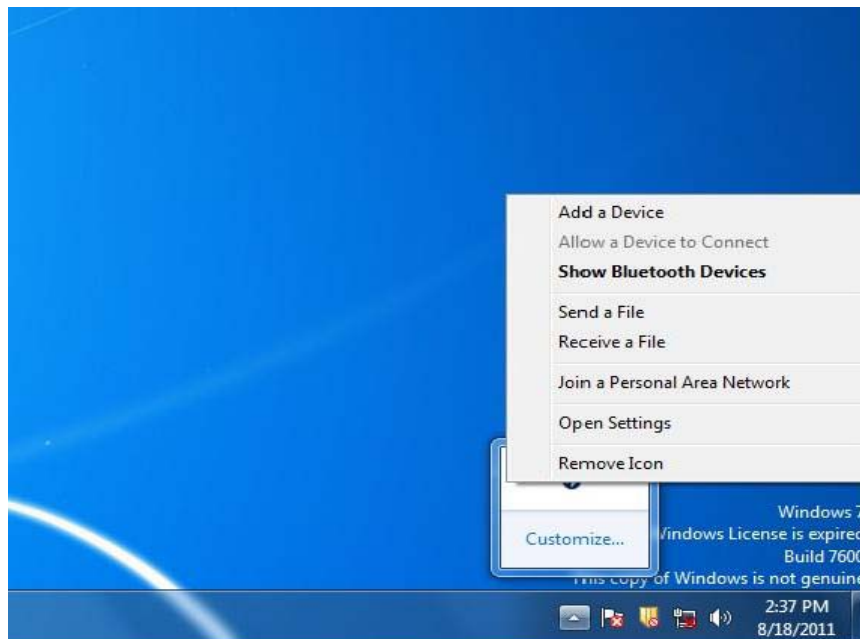

Figure 7-21 SPP - Open Setting Screen - Windows 7 SP1

2. Select the **COM Ports** tab and click **Add**.

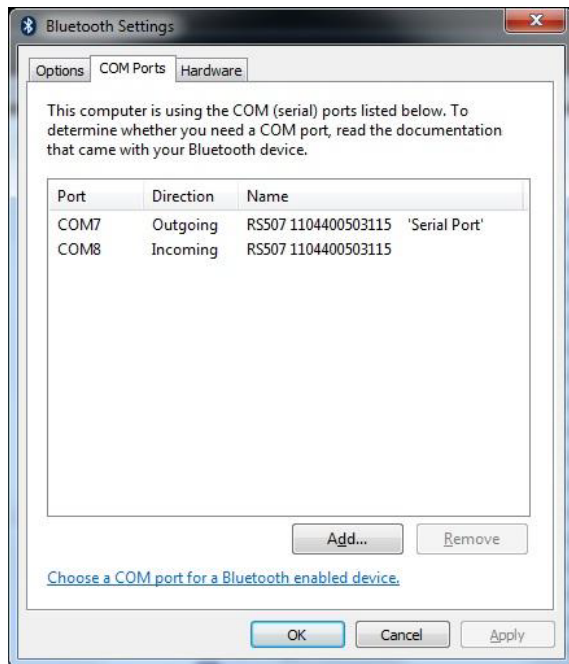
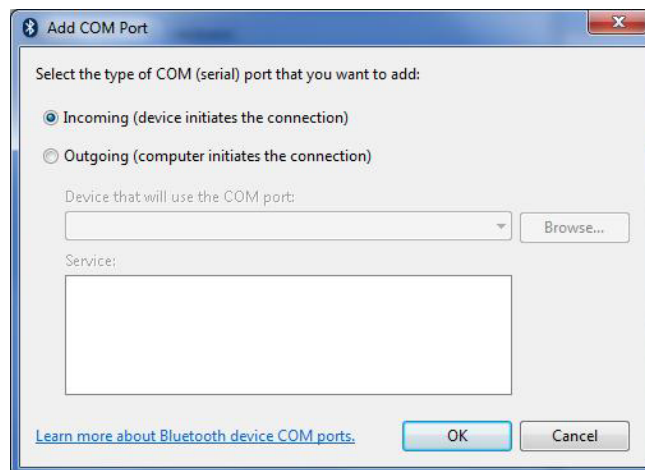

Figure 7-22 SPP - Bluetooth Settings - Com Ports Tab

3. Check the **Incoming** box and click **OK**.



4. SPP - Bluetooth Settings - Add Com Port Screen

5. Click the **Hardware** tab to retrieve the BT radio BD address.

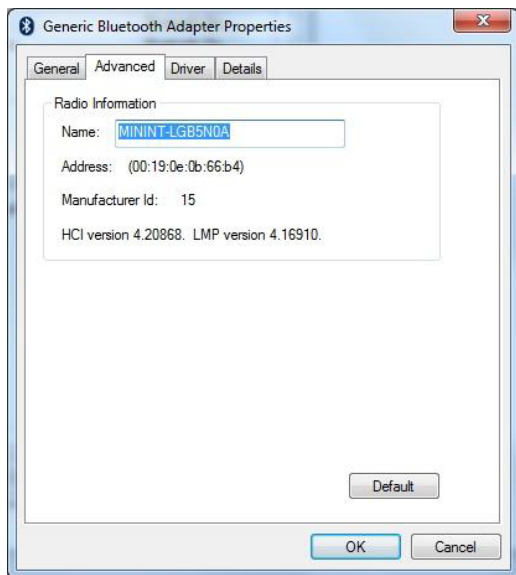

Figure 7-23 SPP - Bluetooth Settings - BT Radio BD Address

6. Run the PC Tool application.

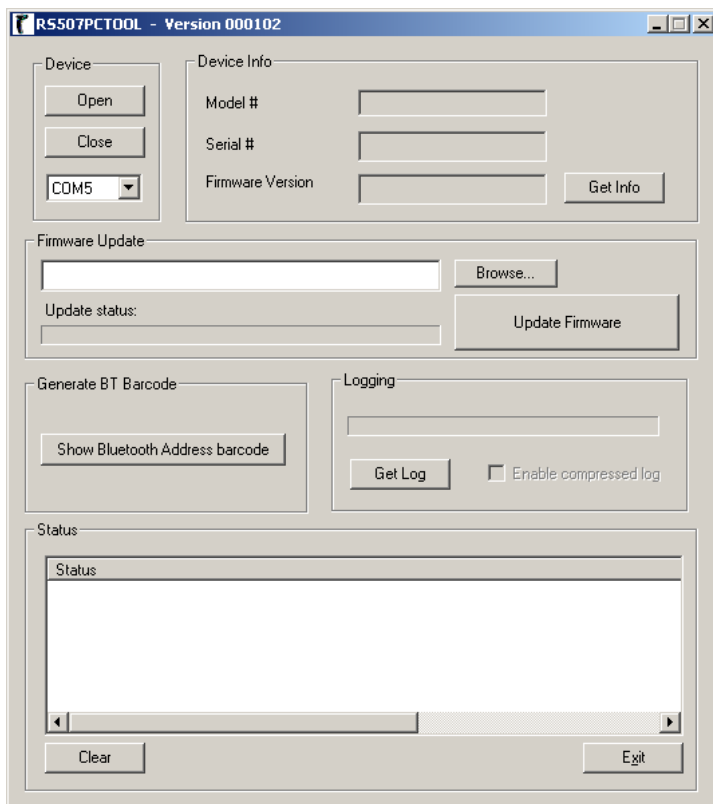

Figure 7-24 SPP - PC Tool application

7. Click the **Show Bluetooth Address barcode** button.

8. Manually enter the BD address to the PC Tool application and click the **Generate** button.

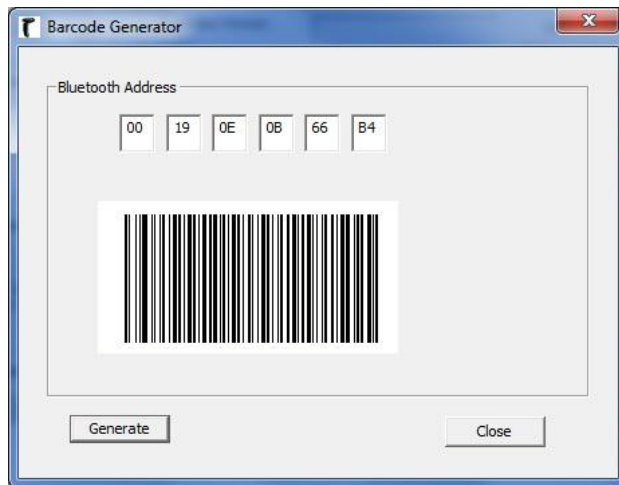

Figure 7-25 SPP - PC Tool Application - Bar Code Generator

9. Open the incoming COM port assigned (for example, COM7) in the application. After the COM port is opened the computer connects to the RS507 and a beep will sound. For demonstration, refer to [How to demonstrate SPP connection with a computer on page 7-34](#).

✓ **NOTE** If the COM port is not opened prior to the connection, the RS507 will fail to connect.

10. To start the connection process:

- Aim the RS507 at about 7" (18 cm) away from the computer screen and scan the bar code of the BD address of the computer (or the other target device).

- The RS507 Scan LEDs start flashing green indicating that the RS507 is attempting to establish connection with the computer. The following notifications are displayed upon successful connection.

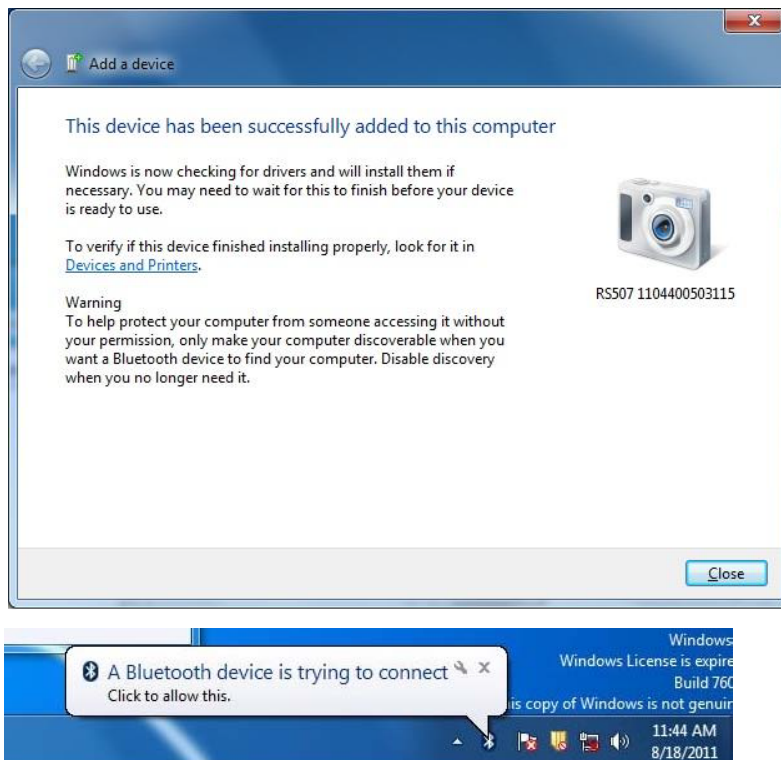

Figure 7-26 SPP - Device Successfully Added Screen

- ✓ **NOTE** In case you do not hear the connected beep on the RS507, press on the RS507 **Restore key** to connect.

SPP connection with RS507 as a Slave

1. Right click the BT icon and select **Open Settings > Add Device**.

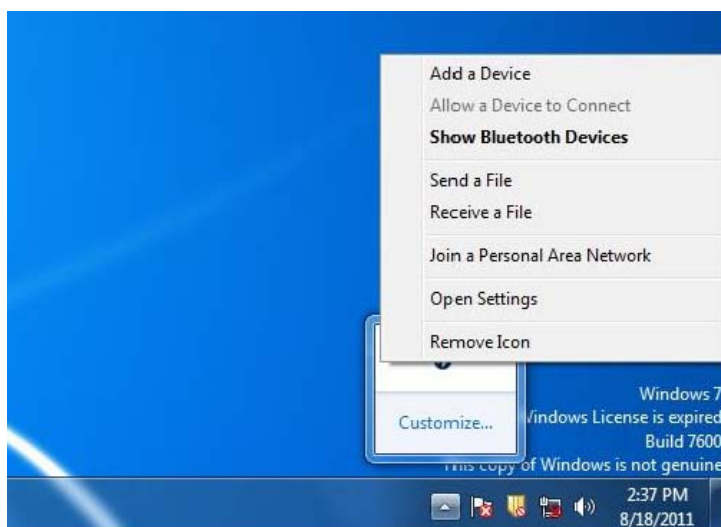

Figure 7-27 SPP connection with RS507 as a Slave - Open Settings

2. Select the RS507 (see Bluetooth Camera icon below) and click **Next**



Figure 7-28 SPP connection with RS507 as a Slave - Add Device Screen

3. The computer attempts to connect to the RS507.

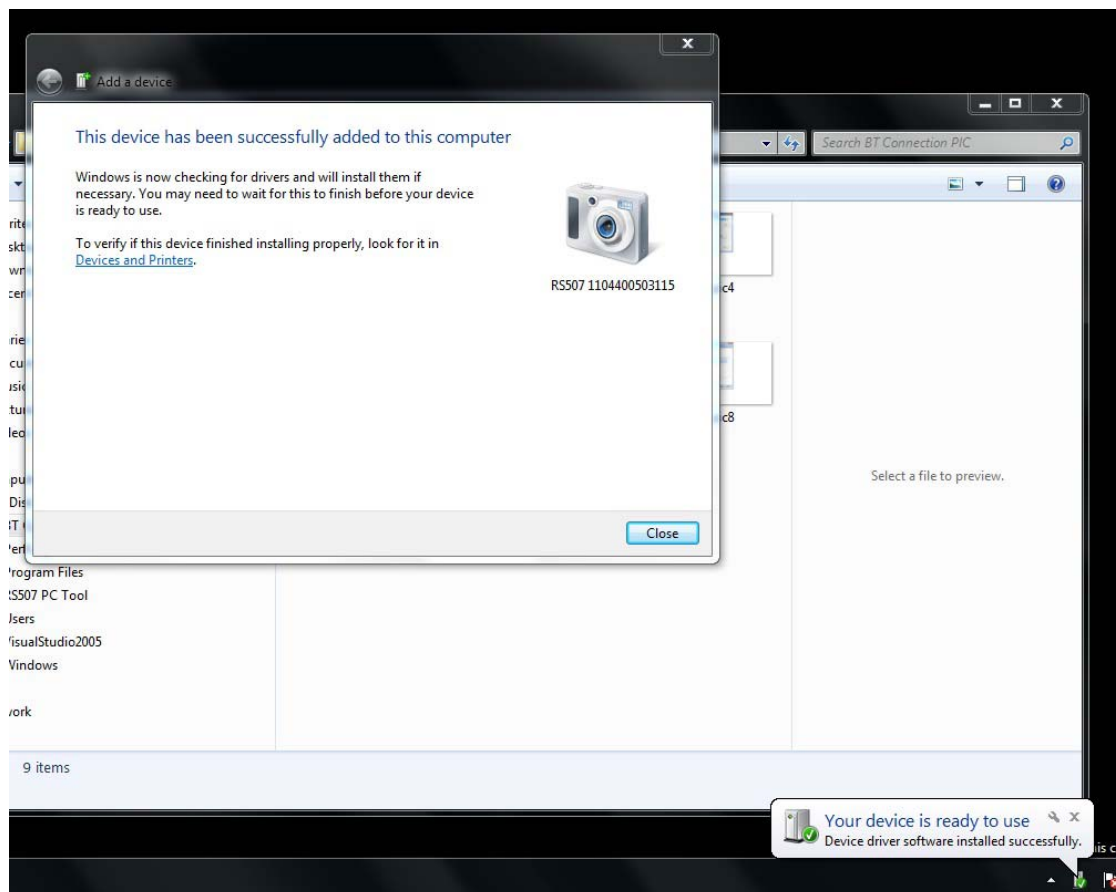

Figure 7-29 SPP connection with RS507 as a Slave - Device Successfully Added Screen

4. Open the incoming COM port assigned (for example, COM7) in the application. After the COM port is opened the computer connects to the RS507 and a beep will sound. For demonstration, refer to [How to demonstrate SPP connection with a computer on page 7-34](#).

✓ **NOTE** Make sure the same COM port is closed in other applications.

How to pair and connect with a computer running Windows XP SP3

SPP connection with RS507 as a Master

To pair the RS507 with a computer:

1. Find the Bluetooth Device (BD) address of the computer (or the target device) in **Bluetooth Configuration > Diagnostics** tab.

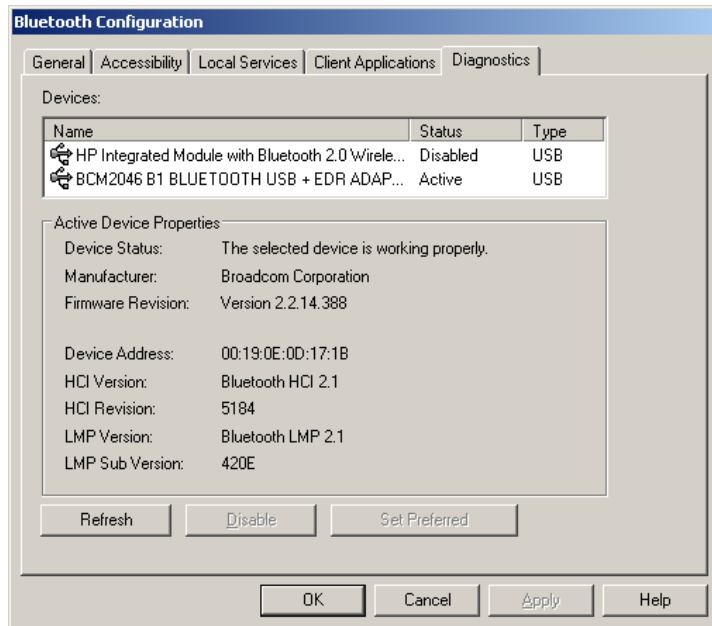

Figure 7-30 Bluetooth Configuration Screen - Windows XP SP3

2. Run the PC Tool application.

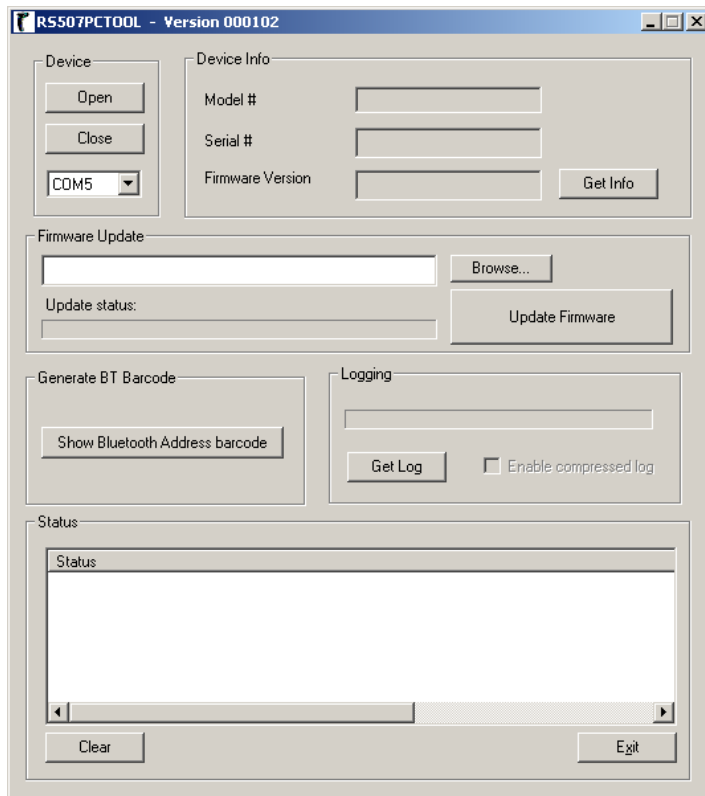

Figure 7-31 PC Tool Application Screen

3. Click the **Show Bluetooth Address barcode** button.
4. Manually enter the computer BD address and click the **Generate** button.

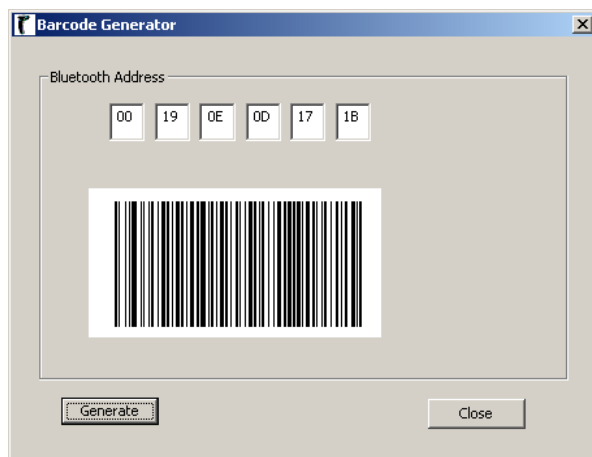

Figure 7-32 .PC Tool Application - Bar Code Generator



NOTE The PC Tool application retains the last BD address entered. To recreate a new bar code image, enter the BD address and click the Generate button.

5. To start the connection process, aim the RS507 at about 7" (18 cm) away from the front of the computer screen.
6. Scan the bar code of the BD address of the computer (or other target device).
7. The RS507 Scan LEDs start flashing green indicating that the RS507 is attempting to establish connection with the computer.
8. Check the **Always allow this device to access this service** box and click **OK**.



Figure 7-33 Bluetooth Service Authorization Dialog

- ✓ **NOTE** When using an earlier BT version that is not equipped with Secure Simple Pairing, a passkey is required only for the first connection. Check the **Let me choose my own passkey** button, enter **12345** and click **Next**.

Upon successful BT pairing, RS507 bleeps and the BT icon in the computer desktop tray turns green.



Figure 7-34 BT Icon In Computer Desktop Tray - Windows XP SP3

At this point, the RS507 is ready to scan and send bar codes over the assigned serial port.

9. Find the assigned serial incoming port, right click the BT icon and select **Bluetooth Configuration > Client Applications** tab.
- ✓ **NOTE** Do not confuse the BT serial port assigned as Incoming (RS507 initiates the connection) with the BT serial port assigned as Outgoing (The computer initiates the connection and RS507 is discovered - Slave Mode).

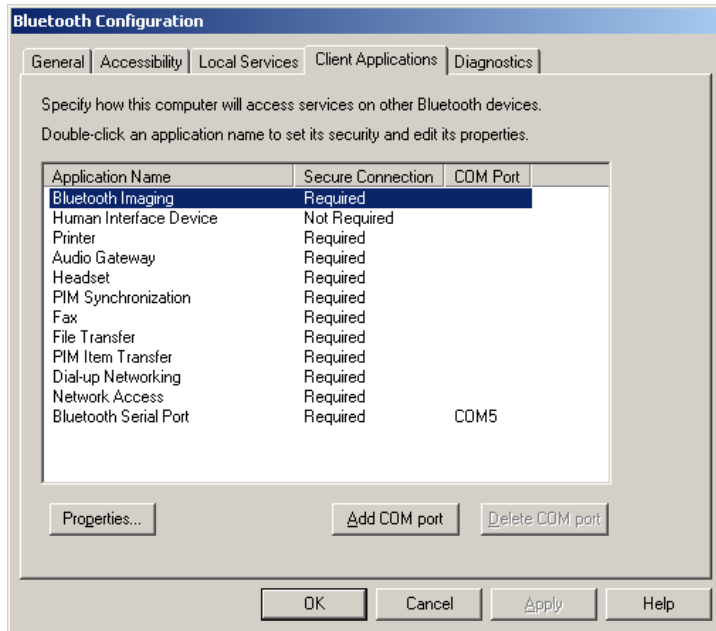

Figure 7-35 Bluetooth Configuration Screen - Windows XP SP3

The COM ports can also be identified through the Control Panel.

To access the BT COM port allocation through the Control Panel:

1. From the **Control Panel** screen, open the **Bluetooth Devices** screen on the computer.

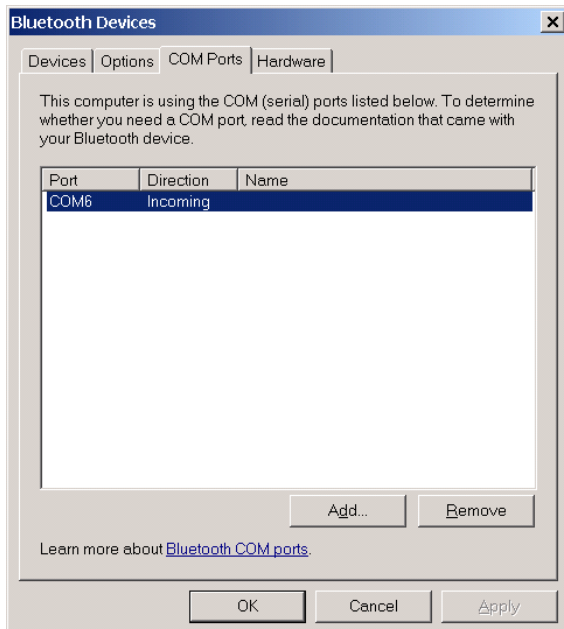

Figure 7-36 Bluetooth Devices screen - Windows XP SP3

2. Click the **COM Ports** tab and verify that a COM port is assigned. If no COM port is assigned, click the **Add** button and select **Incoming (device initiates the connection)** to set the RS507 as Master and the computer as Slave.

3. Click **OK** to complete the settings.

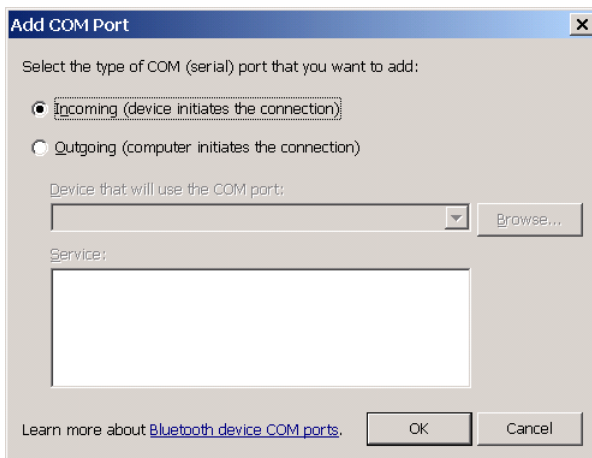

Figure 7-37 Add COM Port Screen - Windows XP SP3

4. After the BT COM port is assigned, run the application on the computer and open the COM port assigned as Incoming in the application (for example, COM7). After the COM port is opened, the computer connects to the RS507 and a beep will sound. For demonstration, refer to [How to demonstrate SPP connection with a computer on page 7-34](#).

✓ **NOTE** If the COM port is not opened prior to the connection, the RS507 will fail to connect. Make sure the same COM port is closed in other applications.

SPP connection with RS507 as a Slave

1. Right click the BT icon on the computer desktop tray.



Figure 7-38 BT Icon In Computer Desktop Tray - SPP connection with RS507 as a Slave

Or

From **My Bluetooth Places** screen, select **Bluetooth Tasks** bar and select **Add a Bluetooth Device**.

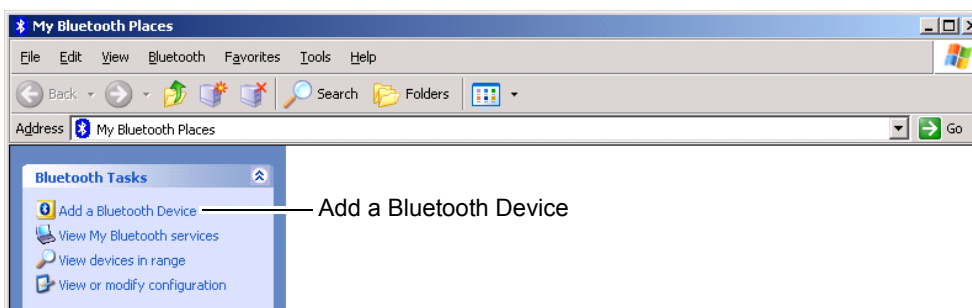

Figure 7-39 My Bluetooth Places Screen - SPP connection with RS507 as a Slave

2. Check **My device set up and ready to be found** box and click **Next**.

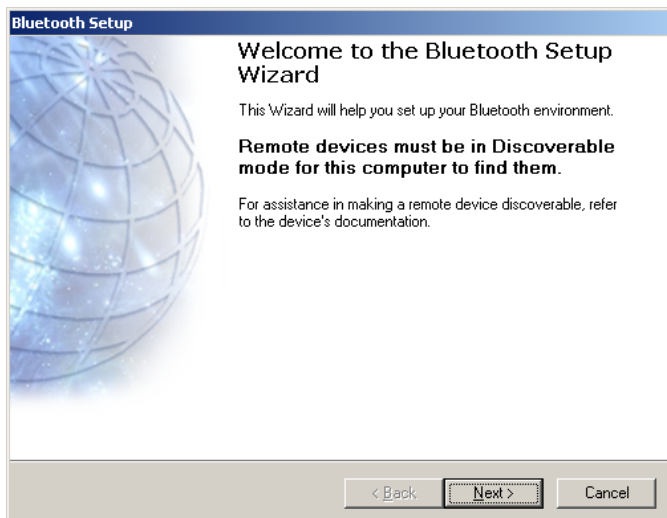

Figure 7-40 Bluetooth Setup Screen - SPP connection with RS507 as a Slave

3. Verify that the RS507 is found by the Host, select the RS507 that you want to add and click **Next**.

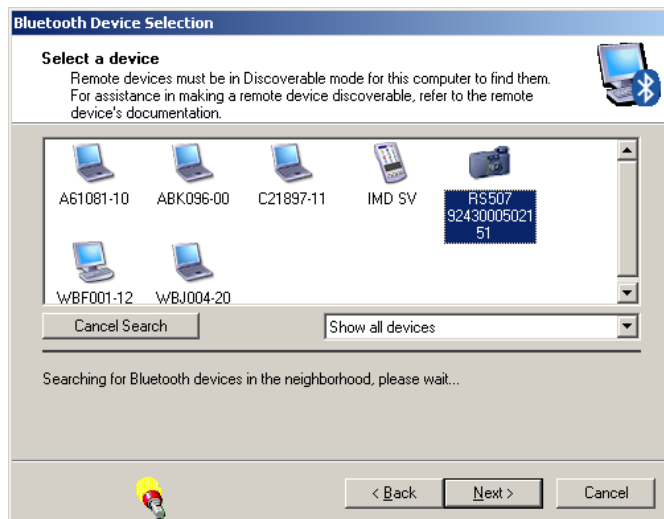

Figure 7-41 Bluetooth Device Selection Screen - SPP connection with RS507 as a Slave

4. Check the **Serial Port** box and click **Next**.

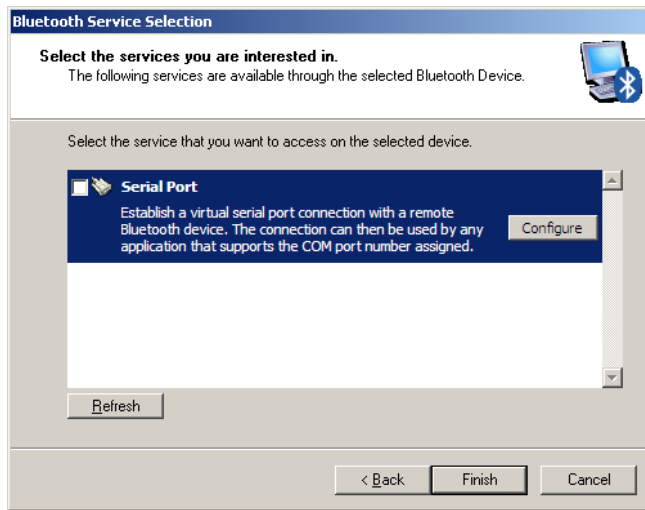
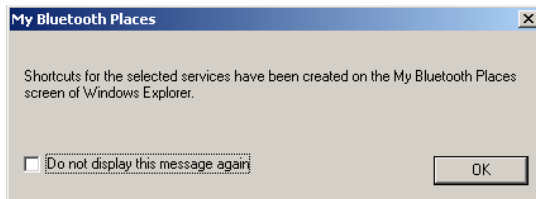

Figure 7-42 Bluetooth Service Selection - Serial Port Screen - SPP connection with RS507 as a Slave

5. The Secure Simple Pairing starts and a shortcut will be created. Click **OK**.



6. Bluetooth Shortcut Confirmation Box - SPP connection with RS507 as a Slave

7. Once completed click **Finish**.



Figure 7-43 Bluetooth Setup Wizard - SPP connection with RS507 as a Slave



NOTE When using an earlier BT version that is not equipped with Secure Simple Pairing, a passkey is required only for the first connection. Check the **Let me choose my own passkey** button, enter **12345** and click Next.

The RS507 is ready to scan and send bar codes over the assigned serial port.

- Find the assigned serial Outgoing port, right click the BT icon and select **Bluetooth Configuration** and the **Local Services** tab.

✓ **NOTE** Do not confuse the BT serial port assigned as Incoming (RS507 initiates the connection) with the BT serial port assigned as Outgoing (The computer initiates the connection and RS507 is discovered - Slave Mode).

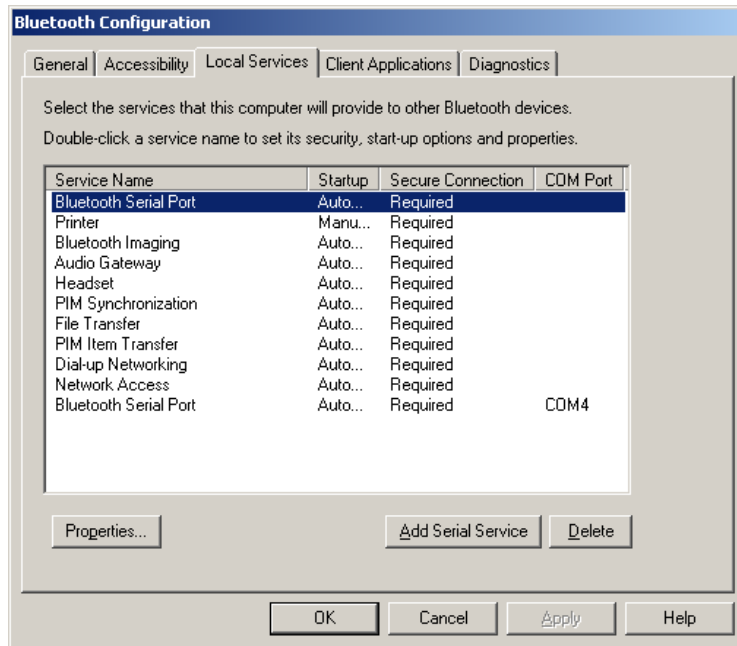

Figure 7-44 Bluetooth Configuration Screen - SPP connection with RS507 as a Slave

- Open the COM port assigned as Incoming COM port in the application (for example, COM7). After the COM port is opened the computer connects to the RS507 and a beep will sound. For demonstration, refer to [How to demonstrate SPP connection with a computer on page 7-34](#).

✓ **NOTE** If the COM port is not opened prior to the connection, the RS507 will fail to connect. Make sure the same COM port is closed in other applications.

How to pair and connect with other devices

The RS507 can pair and connect as a serial port device using the Bluetooth SPP profile to other devices that support SPP using the device either the RS507 as a Master (recommended) or the device discovery feature.

The PC Tool application can be used to generate the Bluetooth Device (BD) address of the target device for testing. Otherwise this bar code can be printed on a label and affixed to the device.

✓ **NOTE** Not all devices support SPP. If the RS507 is not discovered as a serial port device (camera), check with the device vendor.

Reconnecting

Automatic reconnection

The RS507 maintains BT communication with the connected device within a range of 10 meters (30 feet). When the RS507 fails to establish connection or connection is lost during operation:

- The RS507 emits one string of low/high beeps.
- The RS507 automatically attempts to reconnect to the computer for 30 seconds (the **Scan LEDs** flash green).

Manual reconnection to Restore Lost Bluetooth Connection

If automatic re-connection fails, verify that the RS507 is within BT range and briefly press the small Restore key on the side of the RS507 to reconnect.

- The RS507 **Scan LEDs** start to flash green, indicating that the RS507 is attempting to establish connection with the computer.
- The **Scan LEDs** turn off and the RS507 emits one string of low/high beeps indicating that the RS507 is connected and ready for scanning.

✓ **NOTE** When the RS507 is in SPP connection mode, pressing the **Restore key** after a Warm or Cold boot reconnects the RS507 to the last paired device. Connection is established as long as the link key on the device side is not deleted (the authentication key used to establish a link between devices).

How to demonstrate SPP connection with a computer

Once SPP connection is established, an application is required to demonstrate the RS507.

To scan a bar code:

1. If the RS507 is still connected to the PC Tool application, close the COM port on the PC Tool application.
2. Run a hyper terminal application such as the Tera Term application.
(<http://www.ayera.com/teraterm/download.cfm>).

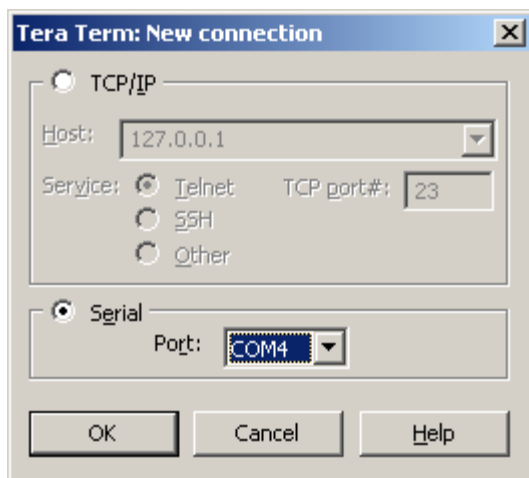

Figure 7-45 Tera Term Application Screen

3. Select the virtual COM port set for the RS507 connection.

4. Scan bar codes. Successful decoding of a bar code is indicated by one green flash of the **Scan LEDs** and a high beep sound. In case of BT disconnection, the RS507 emits one high beep followed by four low beeps.

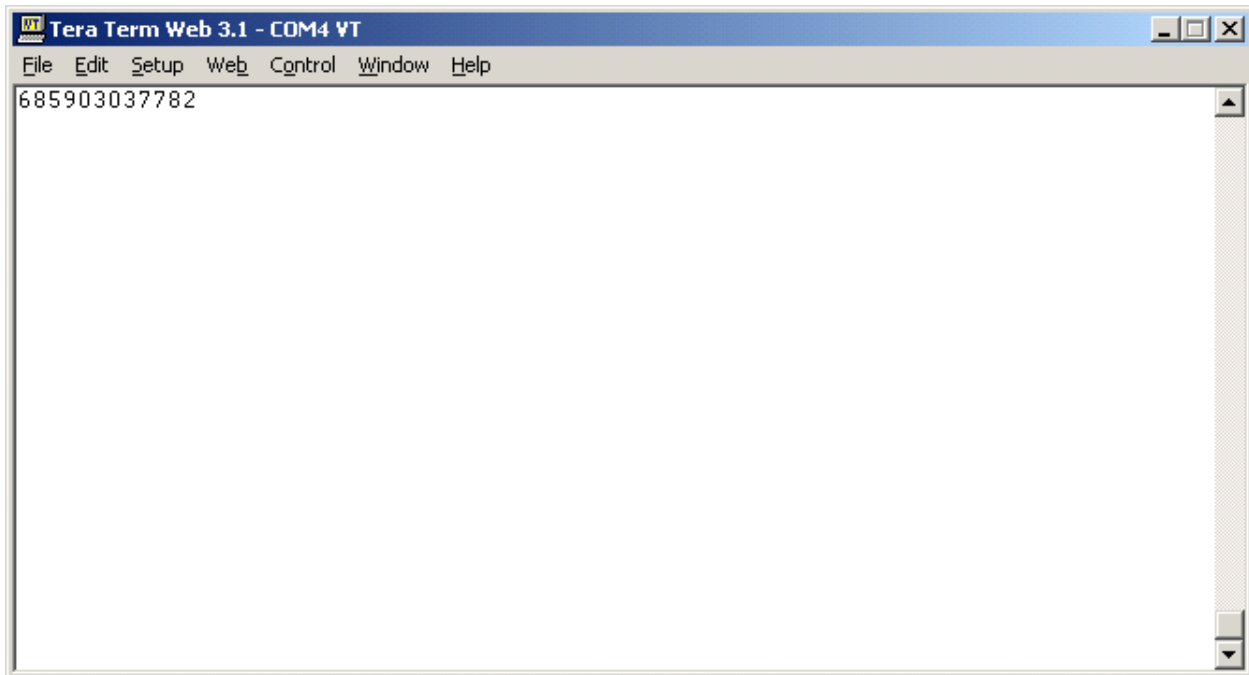

Figure 7-46 Tera Term Entry Screen

Connecting multiple RS507 into single device

Multiple RS507 units can be connected a single computer running an application that accepts more than one RS507, each with its own assigned COM port. The number of RS507 units concurrently connected is depended on the computer's BT stack.

How to return to SSI (SCAN) mode

To change the RS507 to SSI (SCAN) mode:

1. Perform Clean Boot to the RS507:
 - Remove the battery from the RS507.
 - Press and hold the Restore key.
 - Install the Battery onto the RS507.
 - Keep holding the Restore key pressed for about five seconds until a chirp is heard and the **Scan LEDs** flash green.
2. Scan the SSI (SCAN) bar code.

SSI (SCAN) bar code



3. Perform a Cold Boot by removing and re-installing the battery onto the RS507. The RS507 starts to operate under SSI (SCAN) for connection to Motorola terminals.

Switching between SSI (SCAN), HID and SPP

To switch the RS507 from one mode to another:

1. Perform Clean Boot to the RS507:
 - Remove the battery from the RS507.
 - Press and hold the Restore key.
 - Install the Battery onto the RS507.
 - Keep holding the Restore key pressed for about five seconds until a chirp is heard and the **Scan LEDs** flash green.
2. Scan the required profile bar code (see the following bar codes).

SPP bar code



SSI (SCAN) bar code



HID bar code



3. Perform a Cold Boot by removing and re-installing the battery onto the RS507 (see [Cold Boot on page 7-3](#)). The RS507 starts to operate and is also discoverable as a keyboard (HID) or serial device (SPP).

IMPORTANT In Win 7 SP1, when switching between SPP connection and HID connection and vice versa, the RS507 device must be removed from the computer pairing list.

4. Remove the RS507 from the computer BT stack by right clicking the BT icon and selecting **Show Bluetooth Devices**

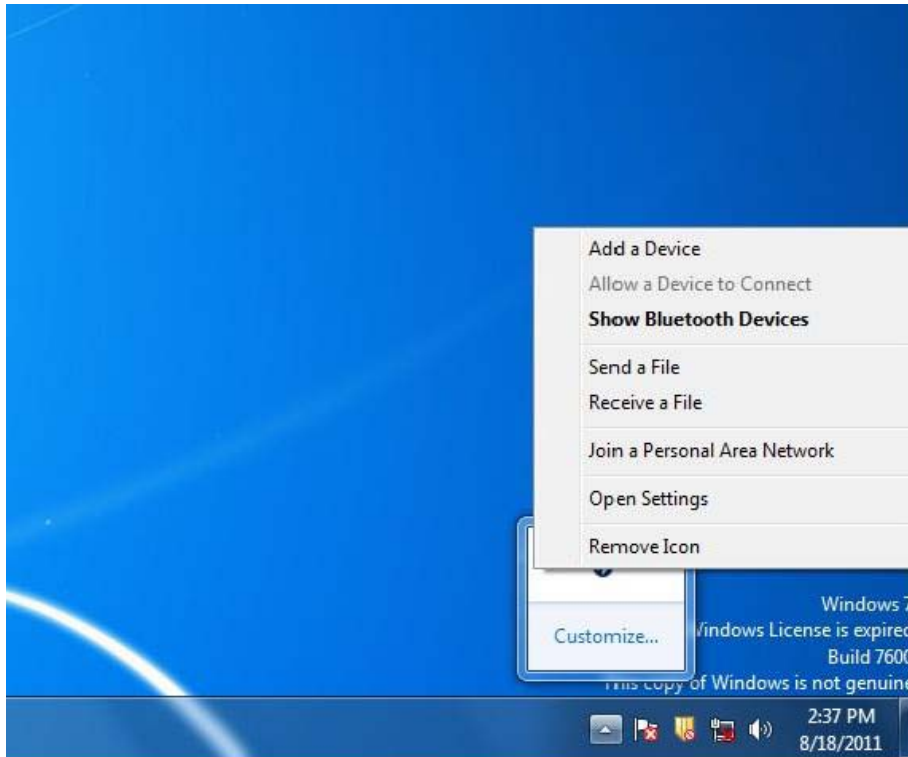

Figure 7-47 Computer BT Stack Screen - Switching Between SSI (SCAN), HID and SPP

5. Right click the RS507 icon (camera icon) and select **Remove device**

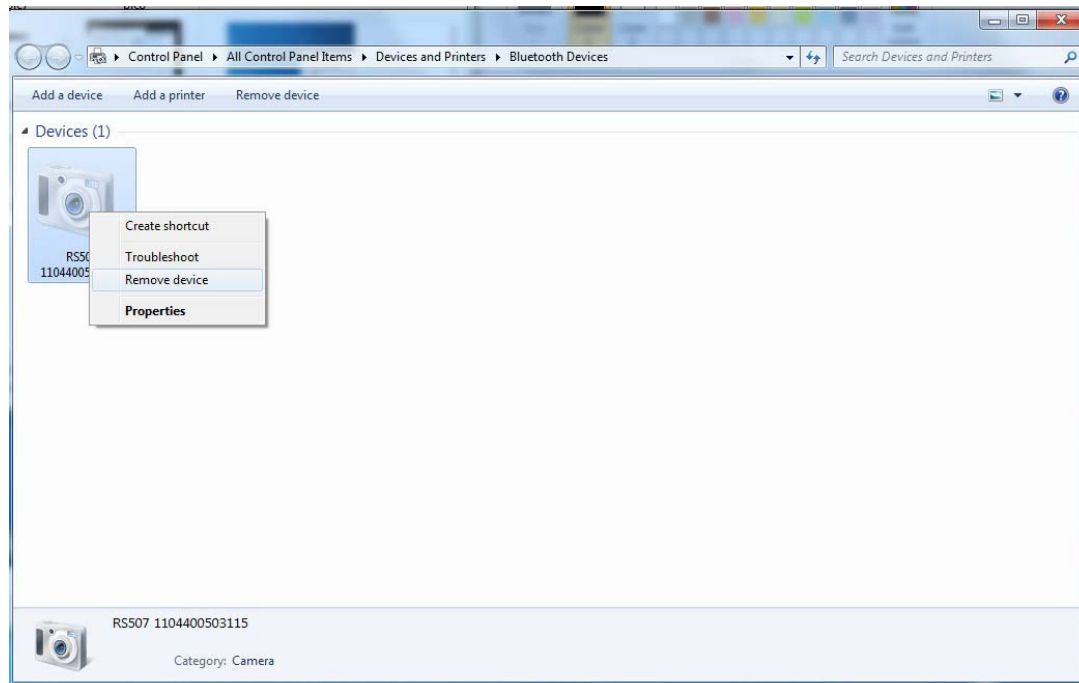

Figure 7-48 Device Screen - Switching Between SSI (SCAN), HID and SPP

IMPORTANT In Win XP SP3:, when switching between SPP connection and HID connection and vice versa, the RS507 device must be removed from the computer pairing list, to remove the RS507 please do as follow:

6. Remove the RS507 from the BT stack by selecting it on the **My Bluetooth Places > Entire Bluetooth Neighborhood**, right click and select **Disable**.

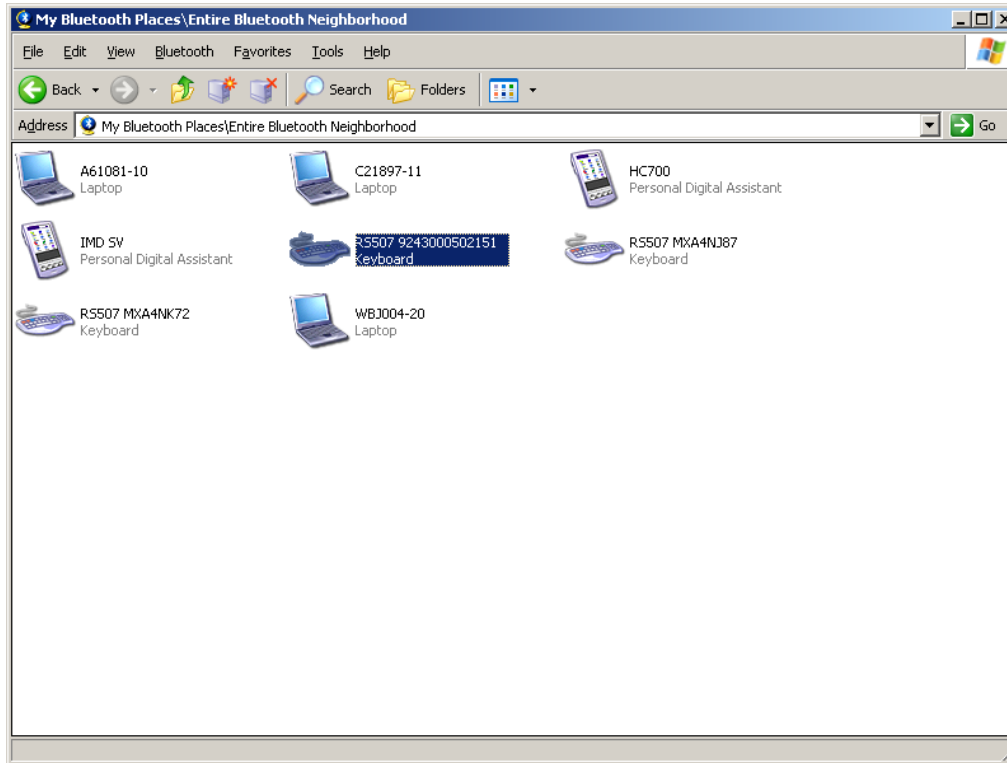

Figure 7-49 Entire Bluetooth Neighborhood Screen - Switching Between SSI (SCAN), HID and SPP

Firmware Rgrade

Upgrading using a computer and the PC Tool application

Older RS507 devices can be upgraded and re-flashed with a new firmware. The update is performed by downloading the firmware to the RS507 flash memory. If download fails, the previous firmware remains operational.

The firmware remains inside the RS507 memory even when powering the RS507 off/on (removing and re-installing the battery).

To update the firmware of the RS507:

1. Install a fully charged RS507 battery and wait until the RS507 emits a beep and stops, indicating that the power up process is completed.
2. Press the Scan trigger and verify that the Scan LEDs illuminate and the aimer light is shown while the scan trigger is pressed.

- Establish SSI connection by scanning the SSI (SCAN) bar code to change the RS507 mode to SSI (SCAN) mode. The SSI (SCAN) mode allows the RS507 to communicate with the computer through SPP during the firmware update session. The SSI (SCAN) bar code can also be scanned directly from a computer screen.

SSI (SCAN) bar code



- Perform a Cold Boot by removing and re-installing the battery onto the RS507. The RS507 starts to operate under SSI mode using an SPP connection with the computer. Notice the COM port that was assigned to the RS507.
- On the computer, run the PC Tool application.

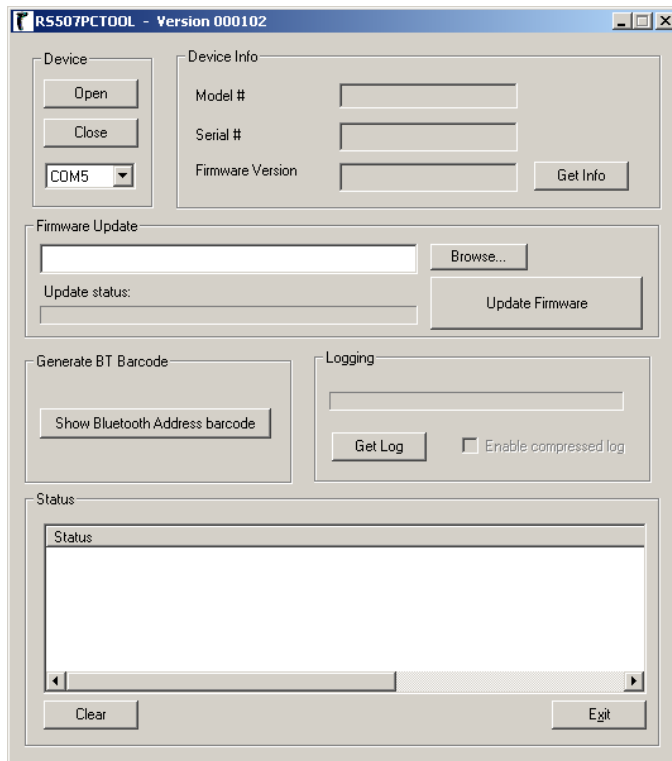

Figure 7-50 PC Tool Application - Firmware Upgrade

✓ **NOTE** When using older BT version, enter PIN code **12345**.

- Follow the instructions for [SPP connection with RS507 as a Master on page 7-19](#) under Windows 7 SP1 or [SPP connection with RS507 as a Master on page 7-26](#) under Windows XP SP3 except, this time use it while the RS507 is in SSI (SCAN) mode.
- Once paired and connected to the computer, select BT COM port.

- Click the **Open** button. The RS507 information is displayed on the *Device Info* fields.

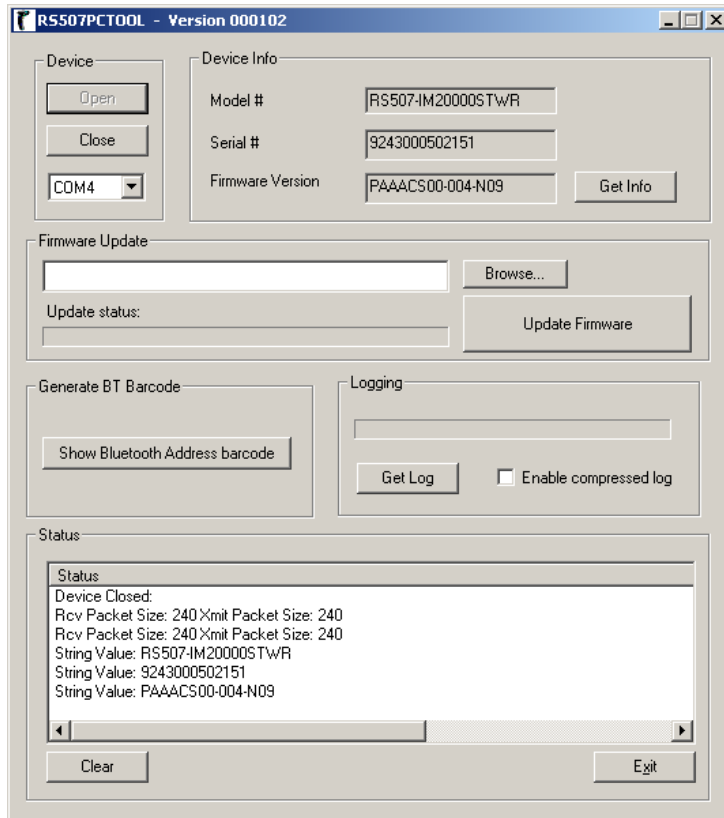

Figure 7-51 PC Tool Application Device Info fields - Firmware Upgrade

9. Press the **Browse** button, select the RS507 firmware dat file (for example: PAAACS00-004-N09D0.dat) and press the **Open** button.

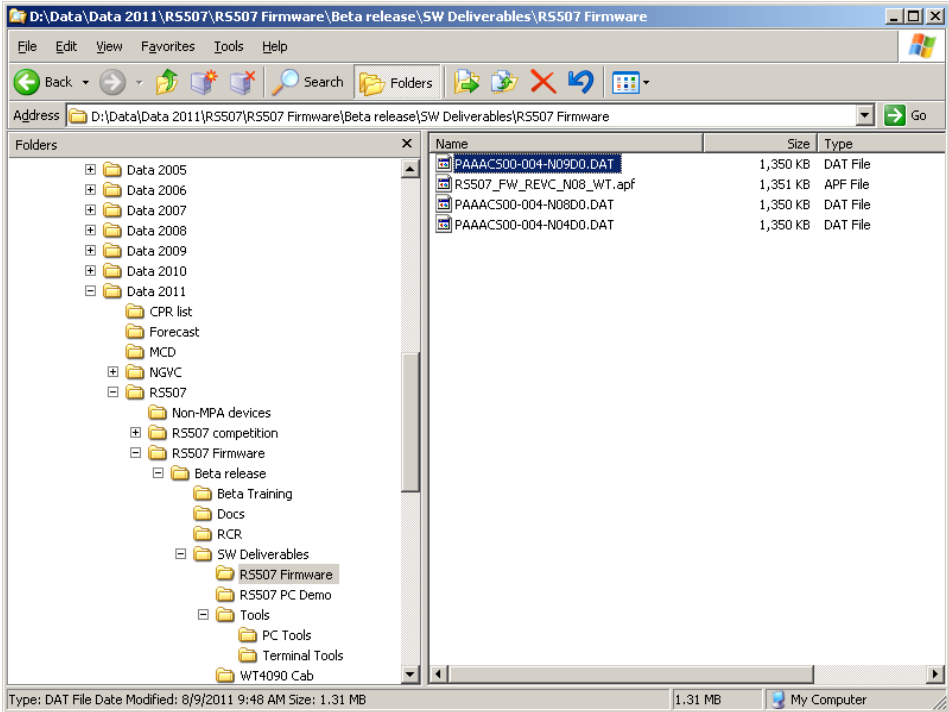

Figure 7-52 Firmware Update - dat File

10. Press the **Update Firmware** button to start the firmware update process.

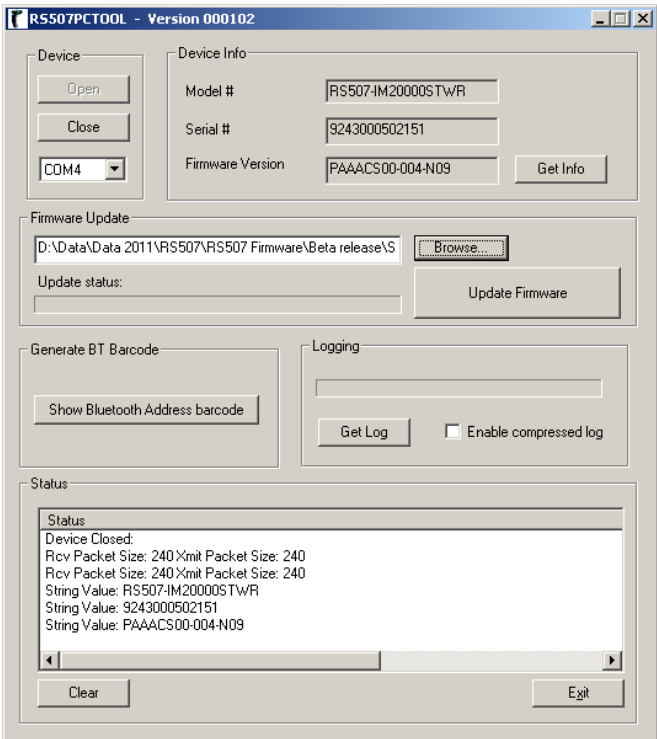

Figure 7-53 Firmware Update - Start Process

11. If the battery level is too low, the firmware update will not start. In such case, replace the battery with a fully charged battery, close the Com port, re-open the Com port and again, start to download.

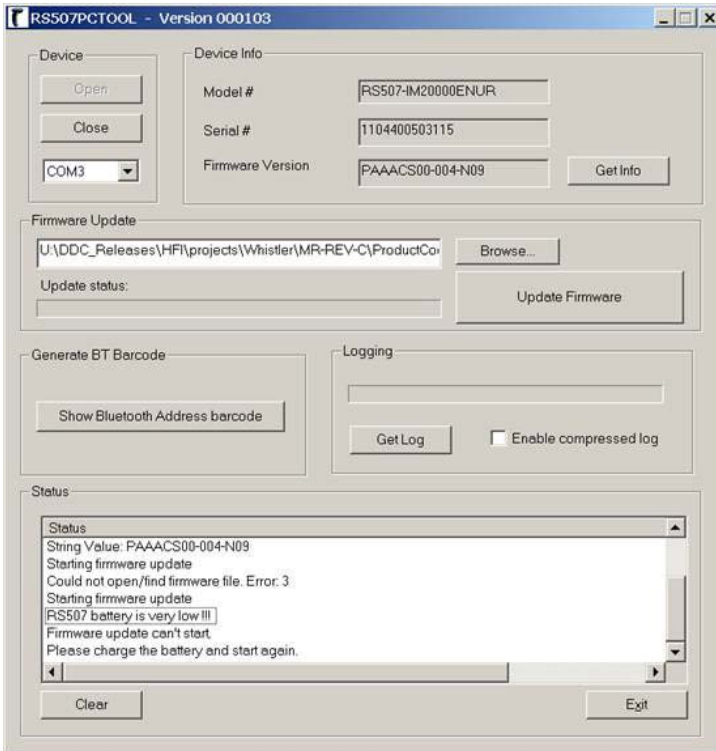

Figure 7-54 Download Screen - PC Tool Application

12. During firmware update, the RS507 Scan LEDs blink red. When the firmware update successfully ends, wait for RS507 internal flash programming to complete (the Scan LEDs turn off).
At the end of the firmware update, the RS507 performs Warm Boot (see [Warm Boot on page 7-3](#)).
13. Perform Clean Boot to the RS507:
- Remove the battery from the RS507.
 - Press and hold the Restore key.
 - Install the battery onto the RS507.
 - Keep holding the Restore key pressed for about five seconds until a chirp is heard and the Scan LEDs flash green.

At this point, the RS507 firmware is updated and ready for connection with the updated firmware.

✓ **NOTE** After Clean Boot is performed, the RS507 defaults are changed to SSI (SCAN) mode to interface to Motorola terminals.

Upgrading with a Motorola terminal

Firmware update utility application was included in the CAB files provided for WT40x0, MC9090, MC709x, MC3090 and VC5090. For step-by-step instructions, refer to [Imager Firmware Update on page 4-18](#).

For firmware update of other terminals, use the PC Tool application.

Retrieving the RS507 log file

The events of the RS507 software log includes debug information and SW diagnostics logged during the RS507 operation. The log is saved on the RAM of the RS507 and is lost once the RS507 battery is removed.

To retrieve the RS507 log file:

1. If the RS507 is stuck or do not behave as expected once connected to the application, do not remove the battery. Instead, perform a Warm Boot by pressing and holding the Restore Key for more than six seconds.
2. Establish SSI connection by scanning the SSI (SCAN) bar code to change the RS507 mode to SSI (SCAN) mode. The SSI (SCAN) mode allows the RS507 to communicate with the computer through SPP during the firmware update session. The SSI (SCAN) bar code can also be scanned directly from a computer screen.

SSI (SCAN) bar code



3. Perform a Warm Boot by pressing and holding the Restore Key for more than six seconds. The RS507 starts to operate under SSI (SCAN) using an SPP connection with the computer.
4. Locate the COM port that was assigned to the RS507.
5. On the computer, run the PC Tool application.

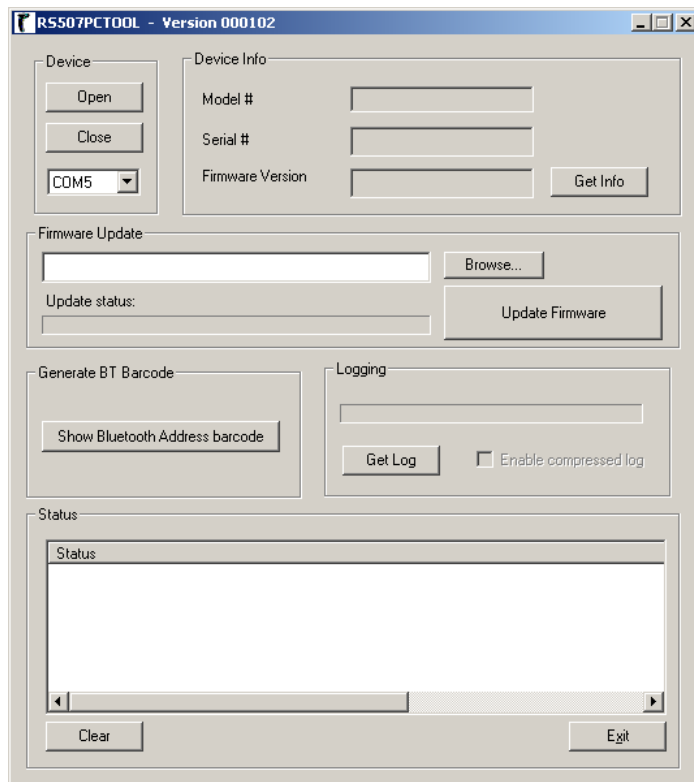

Figure 7-55 PC Tool Application Screen

6. Click the **Show Bluetooth Address barcode** button.
7. Manually enter the computer BD address and click the **Generate** button..

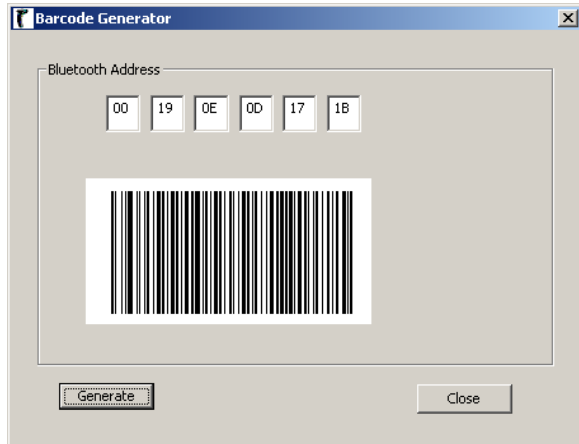

Figure 7-56 Bar Code Generator - PC Tool Application

✓ **NOTE** The PC Tool application retains the last BD address entered so next time press the **Generate** button to recreate the bar code image.

8. To start the connection process, aim the RS507 at about 7" (18 cm) away from the front of the computer screen and scan the bar code of the computer (or the other target device) BD address. The RS507 **Scan LEDs** start flashing green indicating that the RS507 is attempting to establish connection with the computer.
9. If the following Windows pops up, check the box **Always allow this device to access this service** and click **OK**.



10. The RS507 beeps, establishes the SSI over SPP connection and is ready log file retrieval.



11. Select BT COM port assigned to the RS507.

✓ **NOTE** The RS507 can connect to a computer or other device that supports Bluetooth Serial Port Profile interface as either a Master (the RS507 initiate the connection) or a Slave (the computer or other device initiate the connection and the RS507 is discovered by the computer).

12. Click the **Open** button - the application displays the RS507 status information.

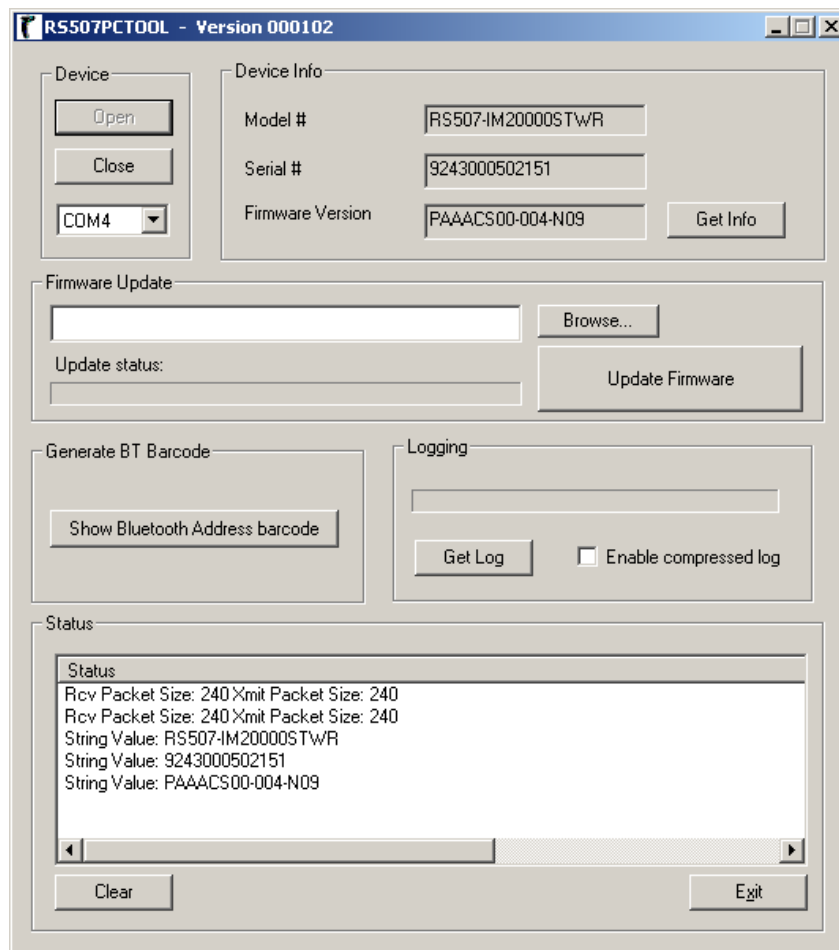

Figure 7-57 RS507 Status Information - PC Tool Application

13. Click the **Get Log** button to download the RS507 log file.
14. When you expect a large log file, check the **Enable compress log** to get a compressed log file in .zip format. The log file is saved on the computer at the same folder of the PC Tool application.

15. from the same directory of the PC Tool application.

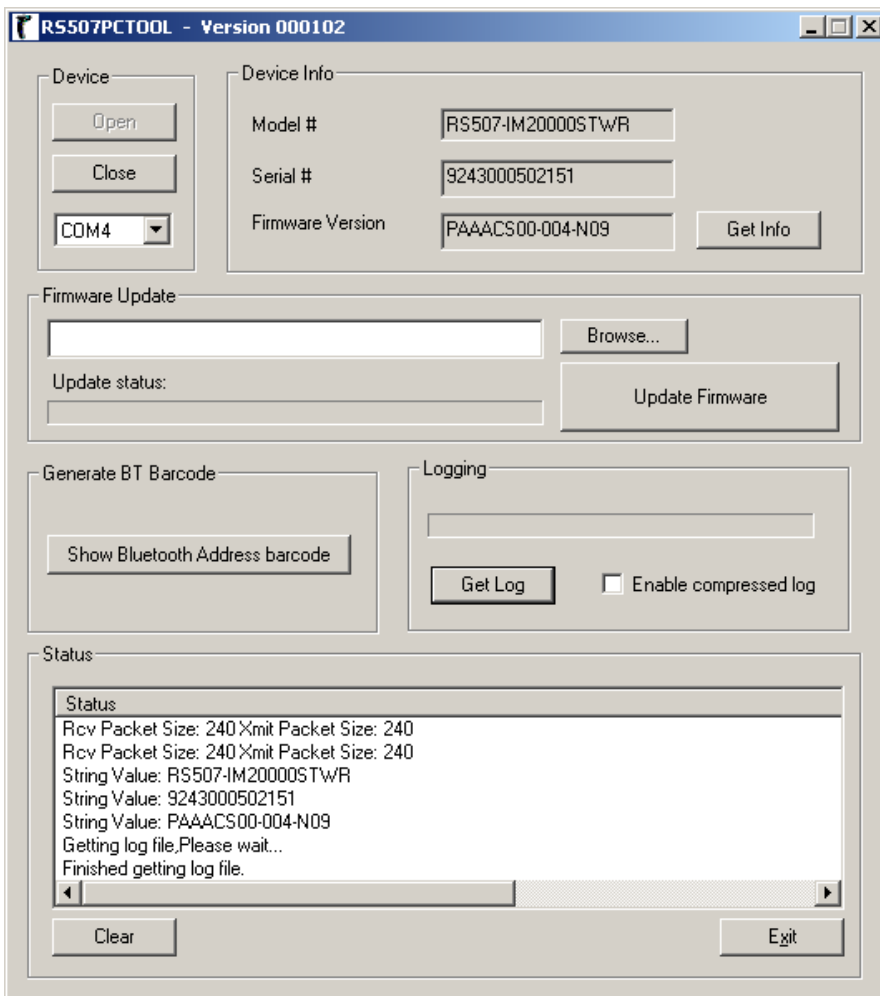

Figure 7-58 Retrieve RS507 Log File - PC Tool Application

Bluetooth Bar Codes

✓ **NOTE** Bar codes marked with * Indicate default configuration.

Bluetooth Authentication Control

Bluetooth Authentication

The Bluetooth Authentication parameter enables/disables Bluetooth authentication connection.

Disable

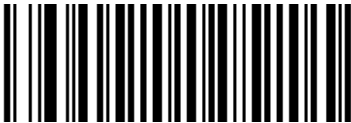

*Enable

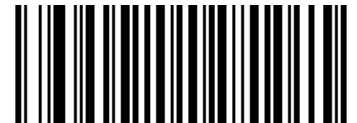

Bluetooth Automatic Reconnection Control

Bluetooth Auto Reconnection

The Bluetooth Auto Reconnection parameter sets Bluetooth automatic reconnection when unexpected Bluetooth disconnection occurs.

*None



On power up



On out of range



Both on power up or out of range



Reconnect Attempts Timeout

The Reconnect Attempts parameter defines the auto reconnect attempt time duration after Bluetooth disconnection.

*30 seconds



35 seconds



40 seconds



45 seconds



50 seconds



55 seconds



60 seconds



Force Pairing Save

The Force Pairing Save parameter enables/disables saving the remote Bluetooth address after each Bluetooth connection attempt.

When this parameter is disabled, the Bluetooth address is saved only after a successful Bluetooth connection. If the Bluetooth connection fails, the Bluetooth address is not saved.

✓ **NOTE** This parameter is effective when the RS507 connects as Master.

Disable



*Enable



Bell Indication Control

BELL Indication (SPP mode only)

The BELL Indication parameter configures the beep tone sequence of the bell indication when a bell character is received. This feature is valid only in SPP mode for PC connection.

*Disable



Enable

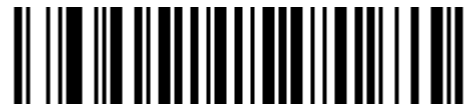

GP_1_HI_SHORT



GP_2_HI_SHORT



GP_3_HI_SHORT



GP_5_HI_SHORT



GP_2_LO_SHORT



GP_4_LO_SHORT



GP_1_HI_LONG



GP_4_HI_SHORT



GP_1_LO_SHORT



GP_3_LO_SHORT



GP_5_LO_SHORT



GP_2_HI_LONG



GP_3_HI_LONG



GP_4_HI_LONG



GP_5_HI_LONG



GP_1_LO_LONG



GP_2_LO_LONG



GP_3_LO_LONG



GP_4_LO_LONG



GP_5_LO_LONG



GP_FAST_WARBLE



GP_HI_LO



GP_HI_LO_HI



GP_HI_HI_LO_LO



APP_CLICK



LOW_CLICK

GP_SLOW_WARBLE



GP_LO_HI



GP_LO_HI_LO



APP_ERROR_BEEP



BT HID Country Keyboard Types (Country Codes)

Scan the bar code corresponding to the keyboard type.



***North American Standard Keyboards**



French Windows



German Windows



French Canadian Windows 98



Spanish Windows



Italian Windows



Swedish Windows



UK English Windows



Japanese Windows



French Canadian Windows 2000/XP



Portuguese/Brazilian Windows

Bluetooth Profile Control

To configure the RS507 to a BT Connection Mode:

1. Scan the required profile bar code (see the following bar codes).
2. Perform a cold boot by removing and re-installing the battery onto the RS507. The RS507 starts to operate and is also discoverable as a keyboard (HID) or serial device (SPP).

SPP bar code



HID bar code



Scan bar code



Bluetooth Pairing Control

Remove Bluetooth Connection

Remove the BT connection to allow the RS507 to connect to another PC or before switching the RS507 to a different connection profile.

To remove the Bluetooth connection, scan an un-pairing bar code to disconnect the RS507 from the PC.

Un-pairing bar code Label



The RS507 emits one string of high/low beeps indicating that BT communication with the PC is removed.

Another way to remove a BT connection is removing and re-installing the RS507 battery.

Chapter 8 Specifications

Technical Specifications

Imager

Table 8-1 *Imager Technical Specifications*

Item	Description
Physical Characteristics	
Dimensions (H x W x L):	Triggerless, standard battery: 2.9 x 5.3 x 7.4 cm/1.16 x 2.1 x 2.92 in. Triggerless, extended battery: 3.6 x 5.3 x 7.4 cm/1.42 x 2.1 x 2.92 in. Triggered, standard battery: 2.9 x 5.3 x 7.4 cm /1.16 x 2.1 x 2.92 in. Triggered, corded (cord length not included): 3.3 x 5.3 x 7.4 cm/1.3 x 2.1 x 2.92 in.
Weight:	Triggerless, standard battery: 121.4 g/4.3 oz. Triggerless, extended battery: 146.4 g/5.2 oz. Triggered, standard battery: 134.8 g/4.8 oz. Triggered, corded: 140.8 g/5.0 oz.
Performance Characteristics	
Optical Resolution:	WVGA 752 H x 480 V pixels (gray scale)
Roll:	360°
Pitch Angle:	± 60° from normal
Skew Tolerance:	± 60° from normal
Aiming Element:	655 nm ± 10 nm Visible Laser Diode
Illumination Element	25 nm ± 5 nm Red LEDs
Field of View:	Horizontal: 39.6°; Vertical: 25.7°

Item	Description																																								
Nominal Working Distance from exit window:	<table border="0"> <tr> <td>Density:</td> <td>5 mil</td> <td>7.5 mil</td> <td>20 mil</td> <td>13 mil</td> </tr> <tr> <td>1D Code Type:</td> <td>39</td> <td>39</td> <td>39</td> <td>UPC</td> </tr> <tr> <td>Near:</td> <td colspan="3">2 inches</td> <td>1.5 inches</td> </tr> <tr> <td>Far:</td> <td>7.4 inches</td> <td>10.5 inches</td> <td>24.6 inches</td> <td>15.4 inches</td> </tr> <tr> <td>Density:</td> <td>6.67 mil</td> <td>10 mil</td> <td colspan="2">15 mil</td> </tr> <tr> <td>2D Code Type:</td> <td>PDF417</td> <td>PDF417</td> <td colspan="2">PDF417</td> </tr> <tr> <td>Near:</td> <td colspan="4">3.3 inches</td> </tr> <tr> <td>Far:</td> <td>7.0 inches</td> <td>10 inches¹</td> <td colspan="2">4.6 inches</td> </tr> </table>	Density:	5 mil	7.5 mil	20 mil	13 mil	1D Code Type:	39	39	39	UPC	Near:	2 inches			1.5 inches	Far:	7.4 inches	10.5 inches	24.6 inches	15.4 inches	Density:	6.67 mil	10 mil	15 mil		2D Code Type:	PDF417	PDF417	PDF417		Near:	3.3 inches				Far:	7.0 inches	10 inches ¹	4.6 inches	
Density:	5 mil	7.5 mil	20 mil	13 mil																																					
1D Code Type:	39	39	39	UPC																																					
Near:	2 inches			1.5 inches																																					
Far:	7.4 inches	10.5 inches	24.6 inches	15.4 inches																																					
Density:	6.67 mil	10 mil	15 mil																																						
2D Code Type:	PDF417	PDF417	PDF417																																						
Near:	3.3 inches																																								
Far:	7.0 inches	10 inches ¹	4.6 inches																																						
Ambient Light Immunity:	<p>From total darkness</p> <p>Indoor: 450 ft. candles (4,845 lux).</p> <p>Outdoor: 9,000 ft. candles (96,900 lux).</p>																																								
Motion Tolerance:	63.5 cm (25 inches) per second, typical.																																								
Supported Symbolologies	<p>1D enabled by default: Codabar, Code 39, Code 128, EAN-13, EAN-8, Interleaved 2 of 5, UPC-A and UPC-E.</p> <p>1D disabled by default: Code 11, Code 32 Pharmaceutical (PARAF), Code 93, MSI, Reduced Space Symbology (RSS-14, RSS Limited, RSS Expanded), Straight 2 of 5 IATA (two-bar start/stop), Straight 2 of 5 Industrial (three-bar start/stop), Trioptic, UPC-E1.</p> <p>2D enabled by default: 4-CB (4-State Customer Bar code), Aztec, MicroPDF417, PDF417, MaxiCode.</p> <p>2D disabled by default: Australian Post, British Post (4 state code and "infomail"), Data Matrix, Japanese Post, KIX (Netherlands) Post, Planet Code, Postnet, QR Code, EAN•UCC Composite, TCIF Linked Code 39 (TLC39).</p>																																								
Supported Aiming Modes:	Class 2 Laser, cross hair with bright center for sunlight visibility; Pick List mode option.																																								
Interface:	<p>Cordless:</p> <p>Bluetooth: Class II, v 2.1 with Adaptive Frequency Hopping (AFH). Supported profiles: Serial Port Profile (SPP), Human Interface Device Profile (HID), Service Discovery Application Profile (SDAP). Pairing: by reading terminal BT address as bar code off the display or from a printed label.</p> <p>Corded (to WT4090): Serial.</p>																																								
Field Replaceable Parts:	Batteries, corded adaptor, trigger clamp, triggerless clamp, comfort pad, straps and strap buckle.																																								

Item	Description
User Interface	
LED:	Two (parallel), multi color, rear left and rear right.
Beeper:	Rear center, up to 80 dBA SPL @ 10 cm.
Restore Key:	User accessible for emergency boot up and Bluetooth reconnect (after excessive disconnection period).
Scan Triggering:	Manual or automatic using Interactive Sensing Technology (IST).
User Environment	
Operating Temperature:	-20° to 55° C/-4° to 131° F.
Storage Temperature:	-40° to 70° C/-40° to 158° F excl. Battery -40° to 60° C/-40° to 140° F incl. Battery
Humidity:	5% to 85% (non-condensing).
Drop Specification:	6 ft./1.8 m multiple drops to concrete across operating temperature range.
Sealing:	IP54
Electrostatic Discharge (ESD):	±15kV air discharge, ±8kV direct discharge.
Power	
Cordless:	Standard battery: Li-Ion 970 mAh, 3.7 V with up to 35,000 scans (continuous) or up to 10 hours with 900 scans per hour on a single charge using fresh batteries. Extended battery: Li-Ion 1940 mAh, 3.7 V with up to 70,000 scans (continuous) or up to 20 hours with 900 scans per hour on a single charge using fresh batteries.
Corded:	Corded adaptor to WT4090
Software Compatibility	
	Motorola's Mobility Services Platform (MSP); DataWedge; Wavelink's Terminal Emulation (TE), among others.
Peripherals and Accessories	
Battery charger:	Charger accommodates eight standard and extended batteries simultaneously each with LED indicator and battery age test.
Regulatory	
Electrical Safety:	Certified to UL60950-1, CSA C22.2 No. 60950-1, EN60950-1, IEC 60950-1.
Laser Safety:	CDRH Class II, IEC 60825-1 Class 2.
EMI/RFI:	FCC Part 15 Class B, ICES-003 Class B, European Union EMC and R&TT. Directives, Australian AS/NZS 60950.1.
RoHS:	Compliance with RoHS standards.

Charger

Table 8-2 Imager Technical Specifications

Item	Description
Physical Characteristics	
Dimensions (H x W x L):	10.2 x 11.4 x 26.6 cm (4.02 x 4.49 x 10.50 in.) without cord and external power supply.
Performance Characteristics	
Charging Duration:	Less than 4 hours (for both standard and extended capacity batteries).
User Interface	
LED:	One Bi color LED per charging bay.
Age Test Key	Activate age test cycle for docked batteries.
User Environment	
Operating Temperature:	0° to 50° C/32° to 122° F (charging is performed until battery temperature is 45° C/113° F)
Storage Temperature:	-40° to 85° C/-40° to 158° F
Humidity:	5% to 85% (non-condensing)
Electrostatic Discharge (ESD):	±15kV air discharge, ±8kV direct discharge.
Power	
External Power Supply:	AC Input: 90-264 V AC 50-60 Hz with IEC320 C8 AC inlet DC Output: 12 V/4.17A
Peripherals and Accessories	
RS507 Batteries:	Charges and tests both standard and extended capacity RS507 batteries.
Regulatory	
Electrical Safety:	Certified to UL60950-1, CSA C22.2 No. 60950-1, EN60950-1, IEC 60950-1
EMI/RFI:	FCC Part 15 Class B, ICES-003 Class B
RoHS:	Compliance with RoHS standards.

Appendix A Standard Default Parameters

Standard Default Parameters Table

Table A-1 Standard Default Parameters Table

Parameter	Parameter Number	Default	Page Number
User Preferences			
Set Default Parameter		Set Defaults	5-4
Parameter Bar Code Scanning	ECh	Enabled	5-5
Beep After Good Decode	38h	Enabled	5-5
Beeper Tone	91h	Medium	5-6
Beeper Volume	8Ch	High	5-7
Beeper Duration	F1 74h	Medium	5-8
Picklist Mode	F0h 92h	Disabled	5-10
Fuzzy 1D Processing	F1h 02h	Enabled	5-11
Decoding Illumination	F0h, 2Ah	Enabled	5-12
UPC/EAN			
UPC-A	01h	Enabled	6-7
UPC-E	02h	Enabled	6-7
UPC-E1	0Ch	Disabled	6-8
EAN-8/JAN 8	04h	Enabled	6-8
EAN-13/JAN 13	03h	Enabled	6-9
Bookland EAN	53h	Disabled	6-9

Table A-1 Standard Default Parameters Table (Continued)

Parameter	Parameter Number	Default	Page Number
Decode UPC/EAN/JAN Supplementals (2 and 5 digits)	10h	Ignore	6-10
User-Programmable Supplementals Supplemental 1: Supplemental 2:	F1h 43h F1h 44h		6-13
UPC/EAN/JAN Supplemental Redundancy	50h	10	6-13
Decode UPC/EAN/JAN Supplemental AIM ID	F1h A0h	Combined	6-14
Transmit UPC-A Check Digit	28h	Enabled	6-14
Transmit UPC-E Check Digit	29h	Enabled	6-15
Transmit UPC-E1 Check Digit	2Ah	Enabled	6-15
UPC-A Preamble	22h	System Character	6-16
UPC-E Preamble	23h	System Character	6-17
UPC-E1 Preamble	24h	System Character	6-18
Convert UPC-E to A	25h	Disabled	6-19
Convert UPC-E1 to A	26h	Disabled	6-19
EAN-8/JAN-8 Extend	27h	Disabled	6-22
Bookland ISBN Format	F1h 40h	ISBN-10	6-21
UCC Coupon Extended Code	55h	Enabled	6-22
ISSN EAN	F1h 69h	Disabled	6-22
Code 128			
Code 128	08h	Enabled	6-23
Set Length(s) for Code 128	D1h D2h	Any Length	6-23
GS1-128	0Eh	Enabled	6-24
ISBT 128	54h	Enabled	6-25
ISBT Concatenation	F1h 41h	Disabled	6-26
Check ISBT Table	F1h 42h	Enabled	6-27
ISBT Concatenation Redundancy	DFh	10	6-27
Code 39			
Code 39	00h	Enabled	6-28
Trioptic Code 39	0Dh	Disabled	6-28

Table A-1 Standard Default Parameters Table (Continued)

Parameter	Parameter Number	Default	Page Number
Convert Code 39 to Code 32 (Italian Pharmacy Code)	56h	Disabled	6-29
Code 32 Prefix	E7h	Disabled	6-29
Set Length(s) for Code 39	12h 13h	2 to 55	6-30
Code 39 Check Digit Verification	30h	Disabled	6-31
Transmit Code 39 Check Digit	2Bh	Disabled	6-31
Code 39 Full ASCII Conversion	11h	Disabled	6-32
Buffer Code 39	71h	Disabled	6-32
Code 93			
Code 93	09h	Disabled	6-35
Set Length(s) for Code 93	1Ah 1Bh	4 to 55	6-35
Code 11			
Code 11	0Ah	Disabled	6-37
Set Lengths for Code 11	1Ch 1Dh	4 to 55	6-37
Code 11 Check Digit Verification	34h	Disabled	6-39
Transmit Code 11 Check Digit(s)	2Fh	Disabled	6-40
Interleaved 2 of 5 (ITF)			
Interleaved 2 of 5 (ITF)	06h	Disabled	6-40
Set Lengths for I 2 of 5	16h 17h	14	6-41
I 2 of 5 Check Digit Verification	31h	Disabled	6-43
Transmit I 2 of 5 Check Digit	2Ch	Disabled	6-43
Convert I 2 of 5 to EAN 13	52h	Disabled	6-44
Discrete 2 of 5 (DTF)			
Discrete 2 of 5	05h	Disabled	6-44
Set Length(s) for D 2 of 5	14h 15h	12	6-45
Codabar (NW - 7)			
Codabar	07h	Disabled	6-47
Set Lengths for Codabar	18h 19h	5 to 55	6-47
CLSI Editing	36h	Disabled	6-49
NOTIS Editing	37h	Disabled	6-49

Table A-1 Standard Default Parameters Table (Continued)

Parameter	Parameter Number	Default	Page Number
MSI			
MSI	0Bh	Disabled	6-50
Set Length(s) for MSI	1Eh 1Fh	4 to 55	6-50
MSI Check Digits	32h	One	6-52
Transmit MSI Check Digit	2Eh	Disabled	6-52
MSI Check Digit Algorithm	33h	Mod 10/Mod 10	6-53
Chinese 2 of 5			
Chinese 2 of 5	F0h 98h	Disabled	6-53
Matrix 2 of 5			
Matrix 2 of 5	F1h 6Ah	Disable	6-54
Matrix 2 of 5 Lengths	F1h 6Bh F1h 6Ch	1 Length - 14	6-55
Matrix 2 of 5 Redundancy	F1h 6Dh	Disabled	6-56
Matrix 2 of 5 Check Digit	F1h 6Eh	Disabled	6-56
Transmit Matrix 2 of 5 Check Digit	F1h 6Fh	Disabled	6-57
Inverse 1D	F1h 4Ah	Regular	6-57
Postal Codes			
US Postnet	59h	Disabled	6-58
US Planet	5Ah	Disabled	6-58
Transmit US Postal Check Digit	5Fh	Enabled	6-59
UK Postal	5Bh	Disabled	6-59
Transmit UK Postal Check Digit	60h	Enabled	6-60
Japan Postal	F0h 22h	Disabled	6-60
Australian Postal	F0h 23h	Disabled	6-61
Netherlands KIX Code	F0h 46h	Disabled	6-61
USPS 4CB/One Code/Intelligent Mail	F1h 50h	Disabled	6-62
UPU FICS Postal	F1h 63h	Disabled	6-62
GS1 DataBar			
GS1 DataBar-14	F0h 52h	Disabled	6-63

Table A-1 Standard Default Parameters Table (Continued)

Parameter	Parameter Number	Default	Page Number
GS1 DataBar Limited	F0h 53h	Disabled	6-63
GS1 DataBar Expanded	F0h 54h	Disabled	6-64
Convert GS1 DataBar to UPC/EAN	F0h 8Dh	Disabled	6-64
Composite			
Composite CC-C	F0h 55h	Disabled	6-65
Composite CC-A/B	F0h 56h	Disabled	6-65
Composite TLC-39	F0h 73h	Disabled	6-66
UPC Composite Mode	F0h 58h	Never Linked	6-66
Composite Beep Mode	F0h 8Eh	Beep As Each Code Type is Decoded	6-67
GS1-128 Emulation Mode for UCC/EAN Composite Codes	F0h ABh	Disabled	6-67
2D Symbolgies			
PDF417	0Fh	Enabled	6-68
MicroPDF417	E3h	Disabled	6-68
Code 128 Emulation	7Bh	Disabled	6-69
Data Matrix	F0h 24h	Enabled	6-70
Data Matrix Inverse	F1h 4Ch	Regular	6-70
Maxicode	F0h 26h	Disabled	6-71
QR Code	F0h 25h	Enabled	6-71
QR Inverse	F1h 4Bh	Regular	6-72
MicroQR	F1h 3Dh	Enabled	6-72
Aztec	F1h 3Eh	Enabled	6-73
Aztec Inverse	F1h 4Dh	Regular	6-73
Symbology-Specific Security Levels			
Redundancy Level	4Eh	1	6-74
Security Level	4Dh	0	6-76
Intercharacter Gap Size	F0h 7Dh	Normal	6-77
Report Version			6-77

Table A-1 *Standard Default Parameters Table (Continued)*

Parameter	Parameter Number	Default	Page Number
Macro PDF			
Flush Macro PDF Buffer			6-78
Abort Macro PDF Entry			6-78

Appendix B Programming Reference

Symbol Code Identifiers

Table B-1 *Symbol Code Characters*

Code Character	Code Type
A	UPC-A, UPC-E, UPC-E1, EAN-8, EAN-13
B	Code 39, Code 32
C	Codabar
D	Code 128
E	Code 93
F	Interleaved 2 of 5
G	Discrete 2 of 5, or Discrete 2 of 5 IATA
H	Code 11
J	MSI
K	GS1-128
L	Bookland EAN
M	Trioptic Code 39
N	Coupon Code
R	GS1 DataBar Family
T	UCC Composite, TLC 39
X	PDF417, Macro PDF417, Micro PDF417
z	Aztec, Aztec Rune

Table B-1 *Symbol Code Characters (Continued)*

Code Character	Code Type
P00	Data Matrix
P01	QR Code, MicroQR
P02	Maxicode
P03	US Postnet
P04	US Planet
P05	Japan Postal
P06	UK Postal
P08	Netherlands KIX Code
P09	Australian Postal
P0A	USPS 4CB/One Code/Intelligent Mail
P0B	UPU FICS Postal

AIM Code Identifiers

Each AIM Code Identifier contains the three-character string **Jcm** where:

- J = Flag Character (ASCII 93)
- c = Code Character (see [Table B-2](#))
- m = Modifier Character (see [Table B-3](#))

Table B-2 *Aim Code Characters*

Code Character	Code Type
A	Code 39, Code 39 Full ASCII, Code 32
C	Code 128, Coupon (Code 128 portion)
d	Data Matrix
E	UPC/EAN, Coupon (UPC portion)
e	GS1 DataBar Family
F	Codabar
G	Code 93
H	Code 11
I	Interleaved 2 of 5
L	PDF417, Macro PDF417, Micro PDF417
M	MSI
Q	QR Code, MicroQR
S	Discrete 2 of 5, IATA 2 of 5
U	Maxicode
z	Aztec, Aztec Rune
X	Bookland EAN, Trioptic Code 39, US Postnet, US Planet, UK Postal, Japan Postal, Australian Postal, Netherlands KIX Code, USPS 4CB/One Code/Intelligent Mail, UPU FICS Postal

The modifier character is the sum of the applicable option values based on [Table B-3](#).

Table B-3 *Modifier Characters*

Code Type	Option Value	Option
Code 39	0	No check character or Full ASCII processing.
	1	Reader has checked one check character.
	3	Reader has checked and stripped check character.
	4	Reader has performed Full ASCII character conversion.
	5	Reader has performed Full ASCII character conversion and checked one check character.
	7	Reader has performed Full ASCII character conversion and checked and stripped check character.
	Example: A Full ASCII bar code with check character W, A+I+MI+DW , is transmitted as J A7AIMID where 7 = (3+4).	
Trioptic Code 39	0	No option specified at this time. Always transmit 0.
	Example: A Trioptic bar code 412356 is transmitted as J X0412356	
Code 128	0	Standard data packet, no Function code 1 in first symbol position.
	1	Function code 1 in first symbol character position.
	2	Function code 1 in second symbol character position.
	Example: A Code (EAN) 128 bar code with Function 1 character ^{FNC1} in the first position, AIMID is transmitted as J C1AIMID	
I 2 of 5	0	No check digit processing.
	1	Reader has validated check digit.
	3	Reader has validated and stripped check digit.
	Example: An I 2 of 5 bar code without check digit, 4123, is transmitted as J I04123	
Codabar	0	No check digit processing.
	1	Reader has checked check digit.
	3	Reader has stripped check digit before transmission.
	Example: A Codabar bar code without check digit, 4123, is transmitted as J F04123	
Code 93	0	No options specified at this time. Always transmit 0.
	Example: A Code 93 bar code 012345678905 is transmitted as J G0012345678905	
MSI	0	Check digits are sent.
	1	No check digit is sent.
	Example: An MSI bar code 4123, with a single check digit checked, is transmitted as J M14123	

Table B-3 Modifier Characters (Continued)

Code Type	Option Value	Option
D 2 of 5	0	No options specified at this time. Always transmit 0.
		Example: A D 2 of 5 bar code 4123, is transmitted as JS04123
UPC/EAN	0	Standard data packet in full EAN format, i.e. 13 digits for UPC-A, UPC-E, and EAN-13 (not including supplemental data).
	1	Two digit supplemental data only.
	2	Five digit supplemental data only.
	3	Combined data packet comprising 13 digits from EAN-13, UPC-A or UPC-E symbol and 2 or 5 digits from supplemental symbol.
	4	EAN-8 data packet.
		Example: A UPC-A bar code 012345678905 is transmitted as JE00012345678905
Bookland EAN	0	No options specified at this time. Always transmit 0.
		Example: A Bookland EAN bar code 123456789X is transmitted as JX0123456789X
Code 11	0	Single check digit
	1	Two check digits
	3	Check characters validated but not transmitted.
GS1 DataBar Family		No option specified at this time. Always transmit 0. GS1 DataBar-14 and GS1 DataBar Limited transmit with an Application Identifier "01". Note: In GS1-128 emulation mode, GS1 DataBar is transmitted using Code 128 rules (i.e., JC1).
		Example: A GS1 DataBar-14 bar code 100123456788902 is transmitted as Je001100123456788902 .
EAN.UCC Composites (GS1 DataBar, GS1-128, 2D portion of UPC composite)		Native mode transmission. Note: UPC portion of composite is transmitted using UPC rules.
	0	Standard data packet.
	1	Data packet containing the data following an encoded symbol separator character.
	2	Data packet containing the data following an escape mechanism character. The data packet does not support the ECI protocol.
	3	Data packet containing the data following an escape mechanism character. The data packet supports the ECI protocol.
		GS1-128 emulation Note: UPC portion of composite is transmitted using UPC rules.
1	Data packet is a GS1-128 symbol (i.e., data is preceded with JJC1).	

Table B-3 Modifier Characters (Continued)

Code Type	Option Value	Option
PDF417, Micro PDF417	0	Reader set to conform to protocol defined in 1994 PDF417 symbology specifications. Note: When this option is transmitted, the receiver cannot reliably determine whether ECIs have been invoked or whether data byte 92 _{DEC} has been doubled in transmission.
	1	Reader set to follow the ECI protocol (Extended Channel Interpretation). All data characters 92 _{DEC} are doubled.
	2	Reader set for Basic Channel operation (no escape character transmission protocol). Data characters 92 _{DEC} are not doubled. Note: When decoders are set to this mode, unbuffered Macro symbols and symbols requiring the decoder to convey ECI escape sequences cannot be transmitted.
	3	The bar code contains a GS1-128 symbol, and the first codeword is 903-907, 912, 914, 915.
	4	The bar code contains a GS1-128 symbol, and the first codeword is in the range 908-909.
	5	The bar code contains a GS1-128 symbol, and the first codeword is in the range 910-911.
	Example: A PDF417 bar code ABCD, with no transmission protocol enabled, is transmitted as]L2ABCD.	
Data Matrix	0	ECC 000-140, not supported.
	1	ECC 200.
	2	ECC 200, FNC1 in first or fifth position.
	3	ECC 200, FNC1 in second or sixth position.
	4	ECC 200, ECI protocol implemented.
	5	ECC 200, FNC1 in first or fifth position, ECI protocol implemented.
	6	ECC 200, FNC1 in second or sixth position, ECI protocol implemented.
MaxiCode	0	Symbol in Mode 4 or 5.
	1	Symbol in Mode 2 or 3.
	2	Symbol in Mode 4 or 5, ECI protocol implemented.
	3	Symbol in Mode 2 or 3, ECI protocol implemented in secondary message.

Table B-3 *Modifier Characters (Continued)*

Code Type	Option Value	Option
QR Code	0	Model 1 symbol.
	1	Model 2 / MicroQR symbol, ECI protocol not implemented.
	2	Model 2 symbol, ECI protocol implemented.
	3	Model 2 symbol, ECI protocol not implemented, FNC1 implied in first position.
	4	Model 2 symbol, ECI protocol implemented, FNC1 implied in first position.
	5	Model 2 symbol, ECI protocol not implemented, FNC1 implied in second position.
	6	Model 2 symbol, ECI protocol implemented, FNC1 implied in second position.
Aztec	0	Aztec symbol.
	C	Aztec Rune symbol.

Appendix C Sample Bar Codes

Code 39



UPC/EAN

UPC-A, 100%



EAN-13, 100%



Code 128



Interleaved 2 of 5



GS1 DataBar-14

✓ **NOTE** DataBar-14 must be enabled to read the bar code below.



7612341562341

PDF417



Data Matrix



Maxicode

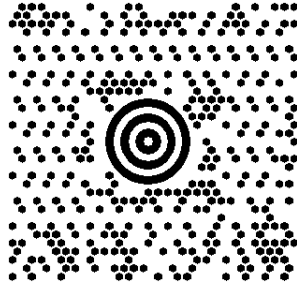

QR Code



US Postnet



UK Postal



Appendix D Numeric Bar Codes

Numeric Bar Codes

For parameters requiring specific numeric values, scan the appropriately numbered bar code(s).



Numeric Bar Codes (continued)



5



6



7



8



9

Cancel

To correct an error or change a selection, scan the bar code below.



Cancel

Glossary

A

Aperture. The opening in an optical system defined by a lens or baffle that establishes the field of view.

API. An interface by means of which one software component communicates with or controls another. Usually used to refer to services provided by one software component to another, usually via software interrupts or function calls

Application Programming Interface. See **API**.

ASCII. American Standard Code for Information Interchange. A 7 bit-plus-parity code representing 128 letters, numerals, punctuation marks and control characters. It is a standard data transmission code in the U.S.

Autodiscrimination. The ability of an interface controller to determine the code type of a scanned bar code. After this determination is made, the information content is decoded.

B

Bar. The dark element in a printed bar code symbol.

Bar Code. A pattern of variable-width bars and spaces which represents numeric or alphanumeric data in machine-readable form. The general format of a bar code symbol consists of a leading margin, start character, data or message character, check character (if any), stop character, and trailing margin. Within this framework, each recognizable symbology uses its own unique format. See **Symbology**.

Bar Code Density. The number of characters represented per unit of measurement (e.g., characters per inch).

Bar Height. The dimension of a bar measured perpendicular to the bar width.

Bar Width. Thickness of a bar measured from the edge closest to the symbol start character to the trailing edge of the same bar.

BIOS. Basic Input Output System. A collection of ROM-based code with a standard API used to interface with standard PC hardware.

Bit. Binary digit. One bit is the basic unit of binary information. Generally, eight consecutive bits compose one byte of data. The pattern of 0 and 1 values within the byte determines its meaning.

Bits per Second (bps). Bits transmitted or received.

Boot or Boot-up. The process a computer goes through when it starts. During boot-up, the computer can run self-diagnostic tests and configure hardware and software.

BOOTP. A protocol for remote booting of diskless devices. Assigns an IP address to a machine and may specify a boot file. The client sends a bootp request as a broadcast to the bootp server port (67) and the bootp server responds using the bootp client port (68). The bootp server must have a table of all devices, associated MAC addresses and IP addresses.

bps. See **Bits Per Second**.

Byte. On an addressable boundary, eight adjacent binary digits (0 and 1) combined in a pattern to represent a specific character or numeric value. Bits are numbered from the right, 0 through 7, with bit 0 the low-order bit. One byte in memory is used to store one ASCII character.

C

CDRH. Center for Devices and Radiological Health. A federal agency responsible for regulating laser product safety. This agency specifies various laser operation classes based on power output during operation.

CDRH Class 1. This is the lowest power CDRH laser classification. This class is considered intrinsically safe, even if all laser output were directed into the eye's pupil. There are no special operating procedures for this class.

CDRH Class 2. No additional software mechanisms are needed to conform to this limit. Laser operation in this class poses no danger for unintentional direct human exposure.

Character. A pattern of bars and spaces which either directly represents data or indicates a control function, such as a number, letter, punctuation mark, or communications control contained in a message.

Character Set. Those characters available for encoding in a particular bar code symbology.

Check Digit. A digit used to verify a correct symbol decode. The scanner inserts the decoded data into an arithmetic formula and checks that the resulting number matches the encoded check digit. Check digits are required for UPC but are optional for other symbologies. Using check digits decreases the chance of substitution errors when a symbol is decoded.

Codabar. A discrete self-checking code with a character set consisting of digits 0 to 9 and six additional characters: (- \$: / , +).

Code 128. A high density symbology which allows the controller to encode all 128 ASCII characters without adding extra symbol elements.

Code 3 of 9 (Code 39). A versatile and widely used alphanumeric bar code symbology with a set of 43 character types, including all uppercase letters, numerals from 0 to 9 and 7 special characters (- . / + % \$ and space). The code name is derived from the fact that 3 of 9 elements representing a character are wide, while the remaining 6 are narrow.

Code 93. An industrial symbology compatible with Code 39 but offering a full character ASCII set and a higher coding density than Code 39.

Code Length. Number of data characters in a bar code between the start and stop characters, not including those characters.

Cold Boot. A cold boot restarts the mobile computer and erases all user stored records and entries.

COM port. Communication port; ports are identified by number, e.g., COM1, COM2.

Continuous Code. A bar code or symbol in which all spaces within the symbol are parts of characters. There are no intercharacter gaps in a continuous code. The absence of gaps allows for greater information density.

Cradle. A cradle is used for charging the terminal battery and for communicating with a host computer, and provides a storage place for the terminal when not in use.

D

Dead Zone. An area within a scanner's field of view, in which specular reflection may prevent a successful decode.

Decode. To recognize a bar code symbology (e.g., UPC/EAN) and then analyze the content of the specific bar code scanned.

Decode Algorithm. A decoding scheme that converts pulse widths into data representation of the letters or numbers encoded within a bar code symbol.

Decryption. Decryption is the decoding and unscrambling of received encrypted data. Also see, **Encryption** and **Key**.

Depth of Field. The range between minimum and maximum distances at which a scanner can read a symbol with a certain minimum element width.

Discrete 2 of 5. A binary bar code symbology representing each character by a group of five bars, two of which are wide. The location of wide bars in the group determines which character is encoded; spaces are insignificant. Only numeric characters (0 to 9) and START/STOP characters may be encoded.

Discrete Code. A bar code or symbol in which the spaces between characters (intercharacter gaps) are not part of the code.

DRAM. Dynamic random access memory.

E

EAN. European Article Number. This European/International version of the UPC provides its own coding format and symbology standards. Element dimensions are specified metrically. EAN is used primarily in retail.

Element. Generic term for a bar or space.

Encoded Area. Total linear dimension occupied by all characters of a code pattern, including start/stop characters and data.

ENQ (RS-232). ENQ software handshaking is also supported for the data sent to the host.

ESD. Electro-Static Discharge

F

Flash Disk. An additional megabyte of non-volatile memory for storing application and configuration files.

Flash Memory. Flash memory is responsible for storing the system firmware and is non-volatile. If the system power is interrupted the data is not be lost.

FTP. See **File Transfer Protocol**.

H

Hard Reset. See **Cold Boot**.

Host Computer. A computer that serves other terminals in a network, providing such services as computation, database access, supervisory programs and network control.

Hz. Hertz; A unit of frequency equal to one cycle per second.

I

IDE. Intelligent drive electronics. Refers to the solid-state hard drive type.

IEC. International Electrotechnical Commission. This international agency regulates laser safety by specifying various laser operation classes based on power output during operation.

IEC (825) Class 1. This is the lowest power IEC laser classification. Conformity is ensured through a software restriction of 120 seconds of laser operation within any 1000 second window and an automatic laser shutdown if the scanner's oscillating mirror fails.

IEEE Address. See **MAC Address**.

Input/Output Ports. I/O ports are primarily dedicated to passing information into or out of the terminal's memory. Series 9000 mobile computers include Serial and USB ports.

Intercharacter Gap. The space between two adjacent bar code characters in a discrete code.

Interleaved 2 of 5. A binary bar code symbology representing character pairs in groups of five bars and five interleaved spaces. Interleaving provides for greater information density. The location of wide elements (bar/spaces) within each group determines which characters are encoded. This continuous code type uses no intercharacter spaces. Only numeric (0 to 9) and START/STOP characters may be encoded.

Interleaved Bar Code. A bar code in which characters are paired together, using bars to represent the first character and the intervening spaces to represent the second.

Interleaved 2 of 5. A binary bar code symbology representing character pairs in groups of five bars and five interleaved spaces. Interleaving provides for greater information density. The location of wide elements (bar/spaces) within each

group determines which characters are encoded. This continuous code type uses no intercharacter spaces. Only numeric (0 to 9) and START/STOP characters may be encoded.

I/O Ports. interface The connection between two devices, defined by common physical characteristics, signal characteristics, and signal meanings. Types of interfaces include RS-232 and PCMCIA.

IOCTL. Input/Output Control.

IP Address. (Internet Protocol address) The address of a computer attached to an IP network. Every client and server station must have a unique IP address. A 32-bit address used by a computer on a IP network. Client workstations have either a permanent address or one that is dynamically assigned to them each session. IP addresses are written as four sets of numbers separated by periods; for example, 204.171.64.2.

IPX/SPX. Internet Package Exchange/Sequential Packet Exchange. A communications protocol for Novell. IPX is Novell's Layer 3 protocol, similar to XNS and IP, and used in NetWare networks. SPX is Novell's version of the Xerox SPP protocol.

IS-95. Interim Standard 95. The EIA/TIA standard that governs the operation of CDMA cellular service. Versions include IS-95A and IS-95B. See CDMA.

K

Key. A key is the specific code used by the algorithm to encrypt or decrypt the data. Also see, **Encryption** and **Decrypting**.

L

LASER. Light Amplification by Stimulated Emission of Radiation. The laser is an intense light source. Light from a laser is all the same frequency, unlike the output of an incandescent bulb. Laser light is typically coherent and has a high energy density.

Laser Diode. A gallium-arsenide semiconductor type of laser connected to a power source to generate a laser beam. This laser type is a compact source of coherent light.

Laser Scanner. A type of bar code reader that uses a beam of laser light.

LCD. See **Liquid Crystal Display**.

LED Indicator. A semiconductor diode (LED - Light Emitting Diode) used as an indicator, often in digital displays. The semiconductor uses applied voltage to produce light of a certain frequency determined by the semiconductor's particular chemical composition.

Light Emitting Diode. See **LED**.

Liquid Crystal Display (LCD). A display that uses liquid crystal sealed between two glass plates. The crystals are excited by precise electrical charges, causing them to reflect light outside according to their bias. They use little electricity and react relatively quickly. They require external light to reflect their information to the user.

M

MIL. 1 mil = 1 thousandth of an inch.

Misread (Misdecode). A condition which occurs when the data output of a reader or interface controller does not agree with the data encoded within a bar code symbol.

N

Nominal. The exact (or ideal) intended value for a specified parameter. Tolerances are specified as positive and negative deviations from this value.

Nominal Size. Standard size for a bar code symbol. Most UPC/EAN codes are used over a range of magnifications (e.g., from 0.80 to 2.00 of nominal).

NVM. Non-Volatile Memory.

O

ODI. See **Open Data-Link Interface**.

Open Data-Link Interface (ODI). Novell's driver specification for an interface between network hardware and higher-level protocols. It supports multiple protocols on a single NIC (Network Interface Controller). It is capable of understanding and translating any network information or request sent by any other ODI-compatible protocol into something a NetWare client can understand and process.

Open System Authentication. Open System authentication is a null authentication algorithm.

P

PAN . Personal area network. Using Bluetooth wireless technology, PANs enable devices to communicate wirelessly. Generally, a wireless PAN consists of a dynamic group of less than 255 devices that communicate within about a 33-foot range. Only devices within this limited area typically participate in the network.

Parameter. A variable that can have different values assigned to it.

PC Card. A plug-in expansion card for laptop computers and other devices, also called a PCMCIA card. PC Cards are 85.6mm long x 54 mm wide, and have a 68 pin connector. There are several different kinds:

- Type I; 3.3 mm high; use - RAM or Flash RAM
- Type II; 5 mm high; use - modems, LAN adaptors
- Type III; 10.5 high; use - Hard Disks

PCMCIA. Personal Computer Memory Card Interface Association. See **PC Card**.

Percent Decode. The average probability that a single scan of a bar code would result in a successful decode. In a well-designed bar code scanning system, that probability should approach near 100%.

PING. (Packet Internet Groper) An Internet utility used to determine whether a particular IP address is online. It is used to test and debug a network by sending out a packet and waiting for a response.

Print Contrast Signal (PCS). Measurement of the contrast (brightness difference) between the bars and spaces of a symbol. A minimum PCS value is needed for a bar code symbol to be scannable. $PCS = (RL - RD) / RL$, where RL is the reflectance factor of the background and RD the reflectance factor of the dark bars.

Programming Mode. The state in which a scanner is configured for parameter values. See **Scanning Mode**.

Q

Quiet Zone. A clear space, containing no dark marks, which precedes the start character of a bar code symbol and follows the stop character.

QWERTY. A standard keyboard commonly used on North American and some European PC keyboards. "QWERTY" refers to the arrangement of keys on the left side of the third row of keys.

R

RAM. Random Access Memory. Data in RAM can be accessed in random order, and quickly written and read.

Reflectance. Amount of light returned from an illuminated surface.

Resolution. The narrowest element dimension which is distinguished by a particular reading device or printed with a particular device or method.

RF. Radio Frequency.

ROM. Read-Only Memory. Data stored in ROM cannot be changed or removed.

Router. A device that connects networks and supports the required protocols for packet filtering. Routers are typically used to extend the range of cabling and to organize the topology of a network into subnets. See **Subnet**.

RS-232. An Electronic Industries Association (EIA) standard that defines the connector, connector pins, and signals used to transfer data serially from one device to another.

S

Scan Area. Area intended to contain a symbol.

Scanner. An electronic device used to scan bar code symbols and produce a digitized pattern that corresponds to the bars and spaces of the symbol. Its three main components are: 1) Light source (laser or photoelectric cell) - illuminates a bar code.; 2) Photodetector - registers the difference in reflected light (more light reflected from spaces); 3) Signal conditioning circuit - transforms optical detector output into a digitized bar pattern.

Scanning Mode. The scanner is energized, programmed and ready to read a bar code.

Scanning Sequence. A method of programming or configuring parameters for a bar code reading system by scanning bar code menus.

SDK. Software Development Kit

Self-Checking Code. A symbology that uses a checking algorithm to detect encoding errors within the characters of a bar code symbol.

Shared Key. Shared Key authentication is an algorithm where both the AP and the MU share an authentication key.

SHIP. Symbol Host Interface Program.

SID. System Identification code. An identifier issued by the FCC for each market. It is also broadcast by the cellular carriers to allow cellular devices to distinguish between the home and roaming service.

Soft Reset. See **Warm Boot**.

Space. The lighter element of a bar code formed by the background between bars.

Specular Reflection. The mirror-like direct reflection of light from a surface, which can cause difficulty decoding a bar code.

Standard Trigger Mode. The Imager uses this mode when lifted off the counter or removed from the wall mount. In this mode, aim the Imager at a bar code and pull the trigger to decode.

Start/Stop Character. A pattern of bars and spaces that provides the scanner with start and stop reading instructions and scanning direction. The start and stop characters are normally to the left and right margins of a horizontal code.

STEP. Symbol Terminal Enabler Program.

Subnet. A subset of nodes on a network that are serviced by the same router. See **Router**.

Subnet Mask. A 32-bit number used to separate the network and host sections of an IP address. A custom subnet mask subdivides an IP network into smaller subsections. The mask is a binary pattern that is matched up with the IP address to turn part of the host ID address field into a field for subnets. Default is often 255.255.255.0.

Substrate. A foundation material on which a substance or image is placed.

SVTP. Symbol Virtual Terminal Program.

Symbol. A scannable unit that encodes data within the conventions of a certain symbology, usually including start/stop characters, quiet zones, data characters and check characters.

Symbol Aspect Ratio. The ratio of symbol height to symbol width.

Symbol Height. The distance between the outside edges of the quiet zones of the first row and the last row.

Symbol Length. Length of symbol measured from the beginning of the quiet zone (margin) adjacent to the start character to the end of the quiet zone (margin) adjacent to a stop character.

Symbology. The structural rules and conventions for representing data within a particular bar code type (e.g. UPC/EAN, Code 39, PDF417, etc.).

T

TCP/IP. (Transmission Control Protocol/Internet Protocol) A communications protocol used to internetwork dissimilar systems. This standard is the protocol of the Internet and has become the global standard for communications. TCP provides transport functions, which ensures that the total amount of bytes sent is received correctly at the other end. UDP is an alternate transport that does not guarantee delivery. It is widely used for real-time voice and video transmissions where erroneous packets are not retransmitted. IP provides the routing mechanism. TCP/IP is a routable protocol, which means that all messages contain not only the address of the destination station, but the address of a destination network. This allows TCP/IP messages to be sent to multiple networks within an organization or around the world, hence its use in the worldwide Internet. Every client and server in a TCP/IP network requires an IP address, which is either permanently assigned or dynamically assigned at startup.

Telnet. A terminal emulation protocol commonly used on the Internet and TCP/IP-based networks. It allows a user at a terminal or computer to log onto a remote device and run a program.

Terminal Emulation. A “terminal emulation” emulates a character-based mainframe session on a remote non-mainframe terminal, including all display features, commands and function keys. The VC5000 Series supports Terminal Emulations in 3270, 5250 and VT220.

Terminate and Stay Resident (TSR). A program under DOS that ends its foreground execution to remain resident in memory to service hardware/software interrupts, providing background operation. It remains in memory and may provide services on behalf of other DOS programs.

TFTP. (Trivial File Transfer Protocol) A version of the TCP/IP FTP (File Transfer Protocol) protocol that has no directory or password capability. It is the protocol used for upgrading firmware, downloading software and remote booting of diskless devices.

Tolerance. Allowable deviation from the nominal bar or space width.

Transmission Control Protocol/Internet Protocol. See **TCP/IP**.

Trivial File Transfer Protocol. See **TFTP**.

TSR. See **Terminate and Stay Resident**.

U

UDP. User Datagram Protocol. A protocol within the IP protocol suite that is used in place of TCP when a reliable delivery is not required. For example, UDP is used for real-time audio and video traffic where lost packets are simply ignored, because there is no time to retransmit. If UDP is used and a reliable delivery is required, packet sequence checking and error notification must be written into the applications.

UPC. Universal Product Code. A relatively complex numeric symbology. Each character consists of two bars and two spaces, each of which is any of four widths. The standard symbology for retail food packages in the United States.

V

Visible Laser Diode (VLD). A solid state device which produces visible laser light.

W

Warm Boot. A warm boot restarts the mobile computer by closing all running programs. All data that is not saved to flash memory is lost.

Index

Numerics

2D bar codes

aztec	6-73
aztec inverse	6-73
code 128 emulation	6-69
data matrix	6-70
data matrix inverse	6-70
maxicode	6-71
microPDF417	6-68
microQR	6-72
PDF417	6-68
QR code	6-71
QR inverse	6-72

A

Acceptable Aiming Options	1-16
auto-triggering mode	1-14

B

bar codes

Australian postal	6-61
aztec	6-73
aztec inverse	6-73
beep after good decode	5-5
beeper tone	5-6
beeper volume	5-7, 5-8
bookland EAN	6-9
bookland ISBN	6-21
buffering	6-32, 6-33
cancel	D-2
Chinese 2 of 5	6-53
codabar	6-47
codabar CLSI editing	6-49
codabar lengths	6-47

codabar NOTIS editing	6-49
code 11	6-37
code 11 lengths	6-37
code 128	6-23
code 128 emulation	6-69
code 128 lengths	6-23
code 39	6-28
transmit buffer	6-34
code 39 check digit verification	6-31
code 39 full ASCII	6-32
code 39 lengths	6-30
code 39 transmit check digit	6-31
code 93	6-35
code 93 lengths	6-35
composite CC-A/B	6-65
composite CC-C	6-65
composite TLC-39	6-66
convert GS1 databar to UPC/EAN	6-64
convert UPC-E to UPC-A	6-19
convert UPC-E1 to UPC-A	6-19
data matrix	6-70
data matrix inverse	6-70
discrete 2 of 5	6-44
lengths	6-46
EAN zero extend	6-20
EAN-13/JAN-13	6-9
EAN-8/JAN-8	6-8
flush macro buffer/abort macro PDF entry	6-78
FN1 substitution values	5-19
fuzzy 1D processing	5-11
GS1 catabar limited	6-63
GS1 DataBar	6-63
GS1 databar expanded	6-64
GS1 databar-14	6-63
GS1-128	6-24
host triggering	5-10
I 2 of 5 check digit verification	6-43

- I 2 of 5 convert to EAN-13 6-44
- I 2 of 5 transmit check digit 6-43
- illumination 5-12
- interleaved 2 of 5 6-40
 - convert to EAN-13 6-44
 - lengths 6-41
- inverse 1D 6-57
- ISBT 128 6-25
- ISBT concatenation 6-26, 6-27
- ISBT concatenation redundancy 6-27
- ISSN EAN 6-22
- Japan postal 6-60
- matrix 2 of 5 6-54
- matrix 2 of 5 check digit 6-56
- matrix 2 of 5 lengths 6-55
- matrix 2 of 5 redundancy 6-56
- maxicode 6-71
- microPDF417 6-68
- microQR 6-72
- MSI 6-50
- MSI check digit algorithm 6-53
- MSI check digits 6-52
- MSI lengths 6-50
- MSI transmit check digit 6-52
- Netherlands KIX code 6-61
- numeric bar codes D-2
- parameter scanning 5-5
- PDF417 6-68
- picklist modes 5-10
- postal 6-58
- prefix/suffix values 5-17
- QR code 6-71
- QR inverse 6-72
- samples C-1
- scan data options 5-18
- set defaults 5-4
- supplementals 6-10
- symbologies
 - default table 6-2
- transmit code ID character 5-16
- transmit matrix 2 of 5 check digit 6-57
- transmit no read message 5-20
- transmit UK postal check digit 6-60
- transmit US postal check digit 6-59
- UCC coupon extended code 6-22
- UK postal 6-59
- UPC composite mode 6-66
- UPC/EAN
 - coupon code 6-22
 - supp redundancy 6-13, 6-14
- UPC/EAN/JAN
 - supplemental AIM ID format 6-14
 - supplemental redundancy 6-13
- UPC-A 6-7

- UPC-A preamble 6-16
- UPC-A/E/E1 check digit 6-14, 6-15
- UPC-E 6-7
- UPC-E preamble 6-17
- UPC-E1 6-8
- UPU FICS postal 6-62
- US planet 6-58
- US postnet 6-58
- USPS 4CB/One Code/Intelligent Mail 6-62

- battery
 - charging 1-6, 2-5
- Battery Age Test 2-6
- Battery Release 1-6
- beep sequences 1-10
- bright center dot 1-15
- bullets xv

C

- change trigger configuration 1-17
- Charge Status LED 2-6
- Charger 2-1
- charging batteries 1-6, 2-5
- Charging Imager battery 2-5
- Clean Boot 1-17
- codabar bar codes
 - CLSI editing 6-49
 - codabar 6-47
 - lengths 6-47
 - NOTIS editing 6-49
- code 11 bar codes
 - code 11 6-37
 - lengths 6-37
- code 128 bar codes
 - code 128 6-23
 - GS1-128 6-24
 - ISBT 128 6-25
 - ISBT concatenation 6-26, 6-27
 - ISBT concatenation redundancy 6-27
 - lengths 6-23
- code 128 emulation bar codes 6-69
- code 39 bar codes
 - buffering 6-32, 6-33
 - check digit verification 6-31
 - code 39 6-28
 - full ASCII 6-32
 - lengths 6-30
 - transmit check digit 6-31
- code 93 bar codes
 - code 93 6-35
 - lengths 6-35
- code ID character 5-16
- code identifiers
 - AIM code IDs B-3

modifier characters	B-4
Symbol	B-1
Cold Boot	1-17
composite bar codes	
composite CC-A/B	6-65
composite CC-C	6-65
composite TLC-39	6-66
UPC composite mode	6-66
conventions	
notational	xiv
Corded Adapter	1-7
Cradle charger	2-3
Cradle Installation	2-3
Cradle wall mount	2-4
Cross Hair Lines	1-15

D

data matrix bar codes	6-70
default parameters	
standard default table	A-1
symbolologies	6-2
user preferences	5-2
discrete 2 of 5 bar codes	
discrete 2 of 5	6-44

E

exposure options	
illumination	5-12

F

Finger Strap	1-9
--------------	-----

G

getting started	1-6, 2-5
GS1 DataBar	6-63
GS1 databar	
convert GS1 databar to UPC/EAN	6-64

I

illumination	5-12
index and middle fingers	1-8
information, service	xv
interleaved 2 of 5 bar codes	
check digit verification	6-43
convert to EAN-13	6-44
transmit check digit	6-43

M

macro PDF	6-78
flush buffer/abort PDF entry	6-78
Manual Triggering	1-14
matrix 2 of 5 bar codes	6-54
check digit	6-56
lengths	6-55
redundancy	6-56
transmit check digit	6-57
maxicode bar codes	6-71
microPDF417 bar codes	6-68
MSI bar codes	
check digit algorithm	6-53
check digits	6-52
lengths	6-50
MSI	6-50
transmit check digit	6-52

N

notational conventions	xiv
------------------------	-----

P

parts of the mobile computer	1-1
PDF417 bar codes	6-68
postal codes	6-58
Australian postal	6-61
Japan postal	6-60
Netherlands KIX code	6-61
transmit UK postal check digit	6-60
transmit US postal check digit	6-59
UK postal	6-59
UPU FICS postal	6-62
US planet	6-58
US postnet	6-58
USPS 4CB/One Code/Intelligent Mail	6-62

Q

QR code bar codes	6-71
-------------------	------

R

reestablish Bluetooth connection	1-12
Remove Bluetooth connection	1-12
Replaceable Parts	3-9
Resetting	1-17

S

sample bar codes	C-1
scanning	

errors	5-2, 6-2
sequence example	5-2, 6-1
service information	xv
SMDK for C	xv
SSI Simple Serial Interface	7-1
standard default parameters	A-1
Standby	1-10
Strap Buckle	1-5
Symbol Mobility Developer Kit for C	xv
Symbol Scan Orientation	1-15
symbology default parameters	6-2

T

trigger	
programming via host	5-10
Trigger Position	1-5
Trigger Swivel Assembly	1-5

U

unpacking	1-1
unpairing barcode	1-13
UPC/EAN bar codes	
bookland EAN	6-9
bookland ISBN	6-21
check digit	6-14, 6-15
convert UPC-E to UPC-A	6-19
convert UPC-E1 to UPC-A	6-19
EAN zero extend	6-20
EAN-13/JAN-13	6-9
EAN-8/JAN-8	6-8
ISSN EAN	6-22
supplementals	6-10
UCC coupon extended code	6-22
UPC-A	6-7
UPC-A preamble	6-16
UPC-E	6-7
UPC-E preamble	6-17
UPC-E1	6-8
user preferences parameters	5-2

W

Warm Boot	1-17
-----------	------



MOTOROLA

Motorola Solutions, Inc.
1301 E. Algonquin Rd.
Schaumburg, IL 60196-1078, U.S.A.
<http://www.motorolasolutions.com>

MOTOROLA, MOTO, MOTOROLA SOLUTIONS and the Stylized M Logo are trademarks or registered trademarks of Motorola Trademark Holdings, LLC and are used under license. All other trademarks are the property of their respective owners.
© 2011 Motorola Solutions, Inc. All Rights Reserved.