

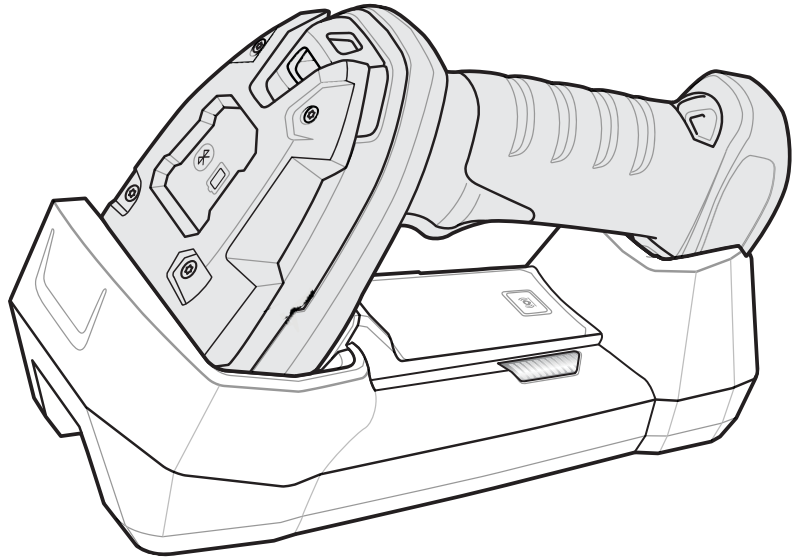

LI3678



Linear Imager Scanner

Quick Start Guide

Zebra reserves the right to make changes to any product to improve reliability, function, or design.

Zebra does not assume any product liability arising out of, or in connection with, the application or use of any product, circuit, or application described herein. No license is granted, either expressly or by implication, estoppel, or otherwise under any patent right or patent, covering or relating to any combination, system, apparatus, machine, material, method, or process in which Zebra products might be used. An implied license exists only for equipment, circuits, and subsystems contained in Zebra products.

Warranty

For the complete Zebra hardware product warranty statement, go to: <http://www.zebra.com/warranty>.

For Australia Only

For Australia Only. This warranty is given by Zebra Technologies Asia Pacific Pte. Ltd., 71 Robinson Road, #05-02/03, Singapore 068895, Singapore. Our goods come with guarantees that cannot be excluded under the Australia Consumer Law. You are entitled to a replacement or refund for a major failure and compensation for any other reasonably foreseeable loss or damage. You are also entitled to have the goods repaired or replaced if the goods fail to be of acceptable quality and the failure does not amount to a major failure.

Zebra Technologies Corporation Australia's limited warranty above is in addition to any rights and remedies you may have under the Australian Consumer Law. If you have any queries, please call Zebra Technologies Corporation at +65 6858 0722. You may also visit our website: <http://www.zebra.com> for the most updated warranty terms.

Service Information

If you have a problem using the equipment, contact your facility's Technical or Systems Support. If there is a problem with the equipment, they will contact the Zebra Global Customer Support Center at: <http://www.zebra.com/support>.

For the latest version of this guide go to: <http://www.zebra.com/support>.

Introduction

The LI3678 cordless linear imager scanner combines excellent scanning performance and advanced ergonomics to provide the best value in a lightweight laser scanner, ensuring comfort and ease of use for extended periods of time.

Features

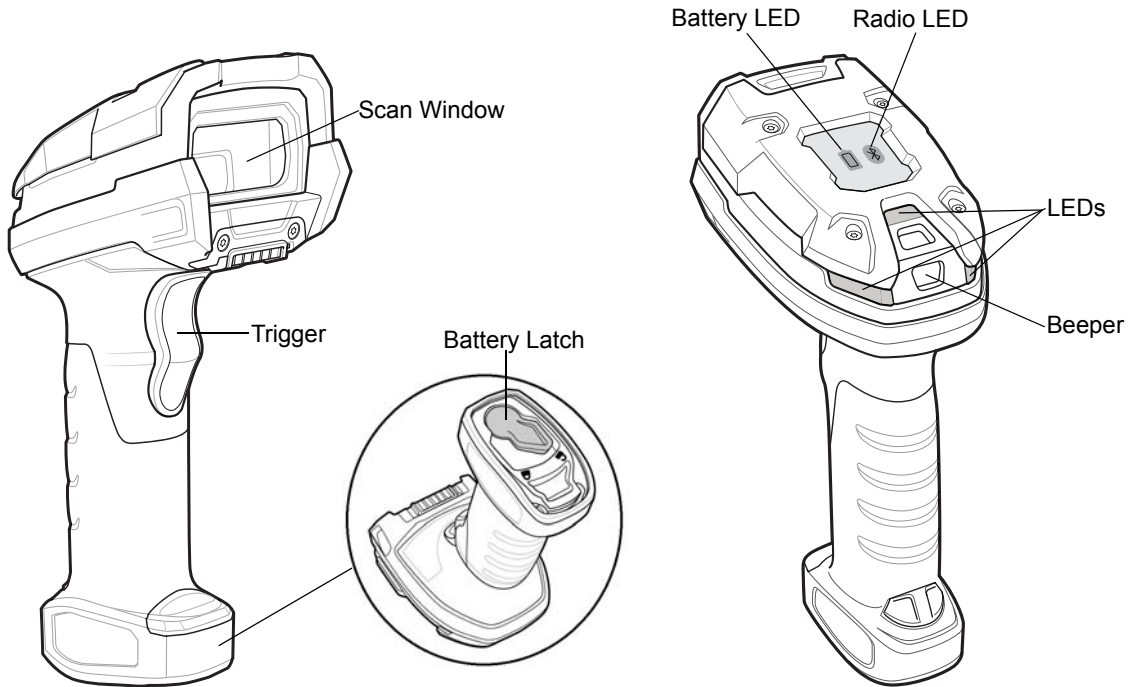

Battery Insertion/Removal

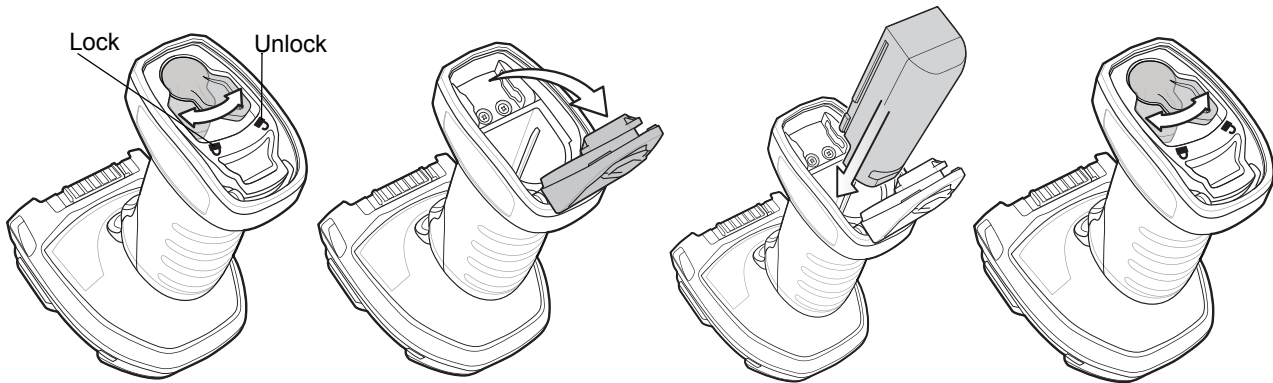

Cradle Cable Connection

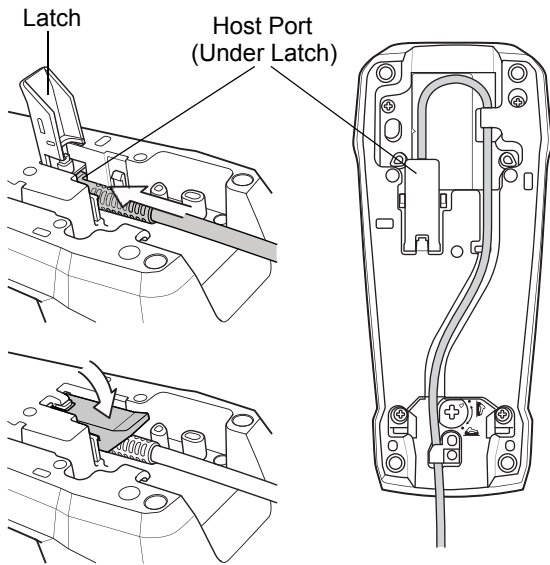

Cradle Insertion.

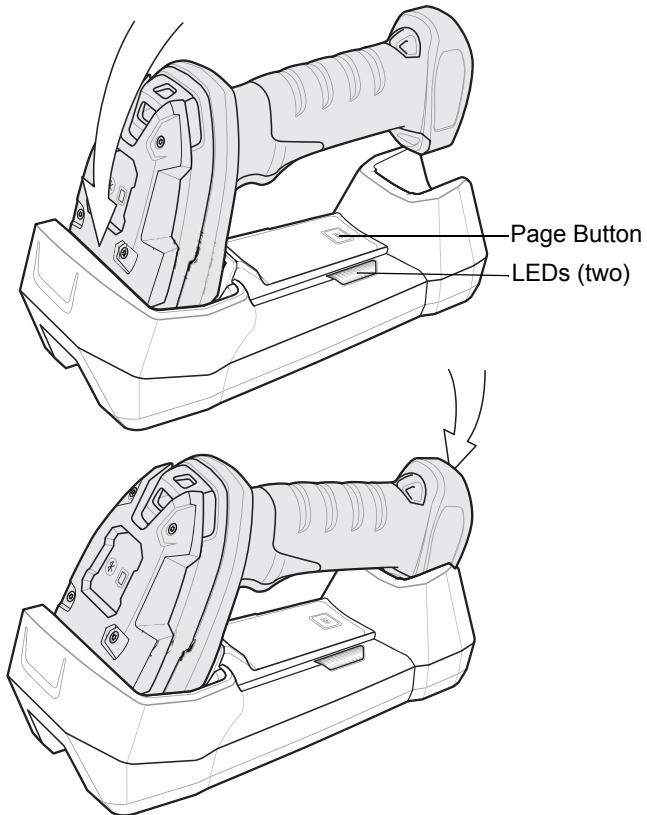

Host Interface Connections and Setup

USB

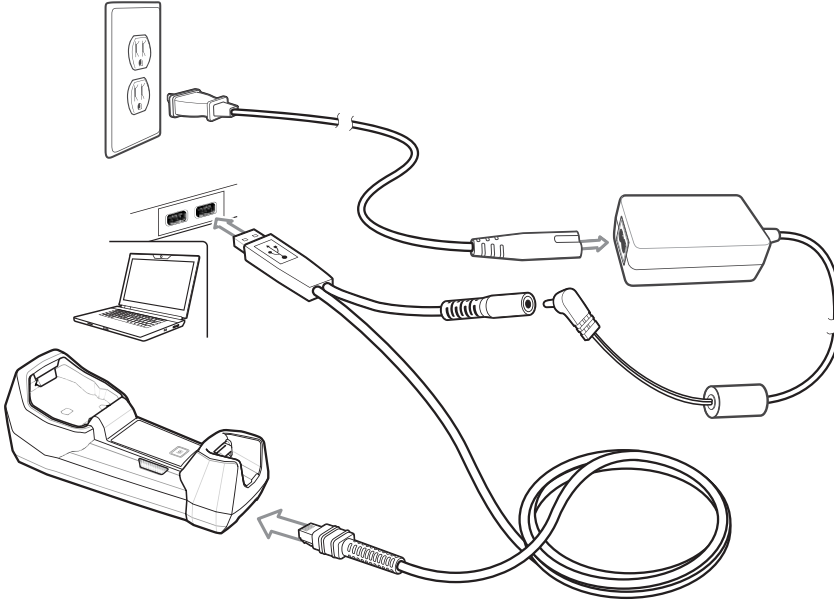

Scan one of the bar codes below

The interface cable automatically detects the host interface type and uses the default setting. If the default (*) does not meet your requirements, scan another host bar code below.

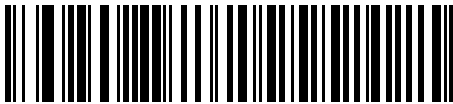

*USB KEYBOARD (HID)



USB CDC HOST

USB (continued)



IBM TABLE TOP USB

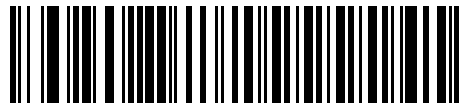

IBM HAND-HELD USB



SNAPI WITHOUT IMAGING



SNAPI WITH IMAGING

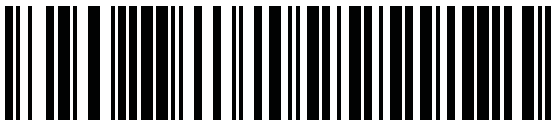

USB OPOS HAND-HELD

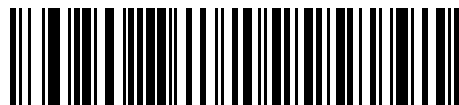

SSI OVER USB CDC

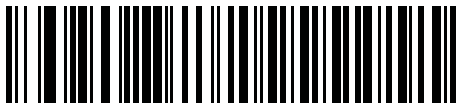

SIMPLE COM PORT EMULATION

RS-232

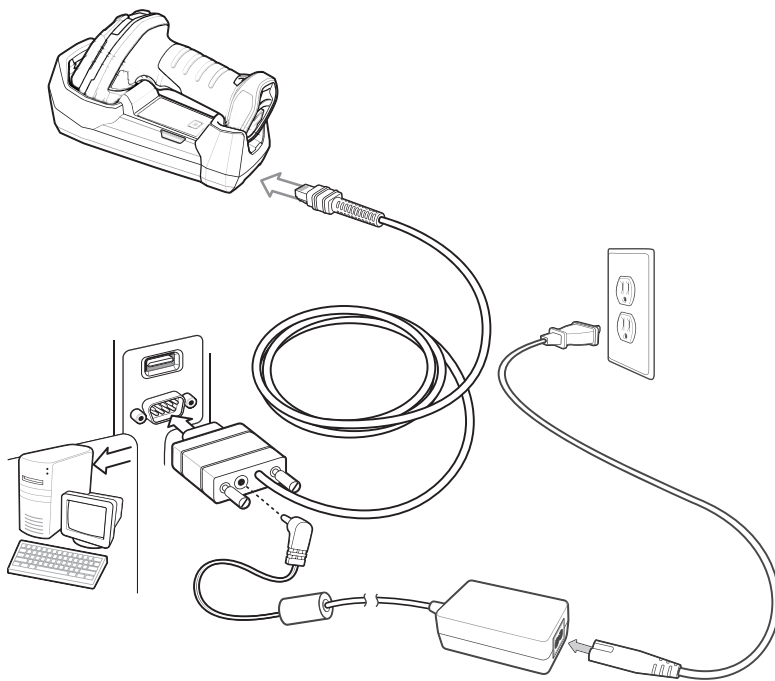

Scan one of the bar codes below

The interface automatically detects the host interface type and uses the default setting. If the default (*) does not meet your requirements, scan another host bar code below.



***STANDARD RS-232**

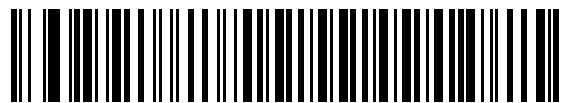

ICL RS-232



NIXDORF RS-232 MODE A



NIXDORF RS-232 MODE B

RS-232 (continued)



FUJITSU RS-232

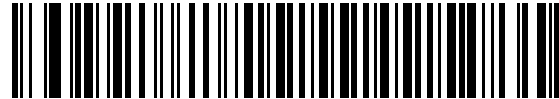

OPOS/JPOS

Keyboard Wedge

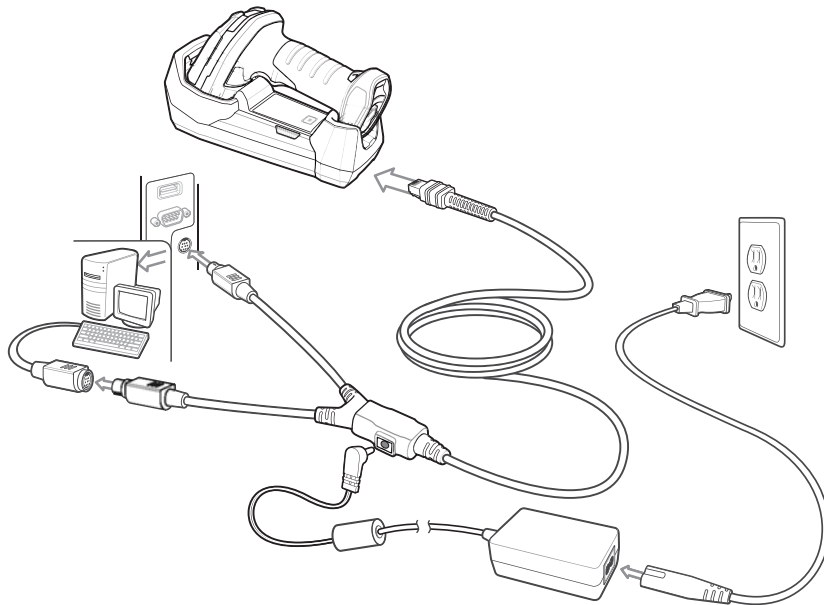

Scan a bar code below

The Auto-Host Detect Cable feature automatically detects the host interface type and uses the default setting. If the default (*) does not meet your requirements, scan the IBM PC/AT and IBM PC COMPATIBLE bar code below.



*IBM AT NOTEBOOK

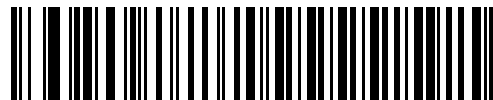

IBM PC/AT and IBM PC COMPATIBLE

IBM 46XX

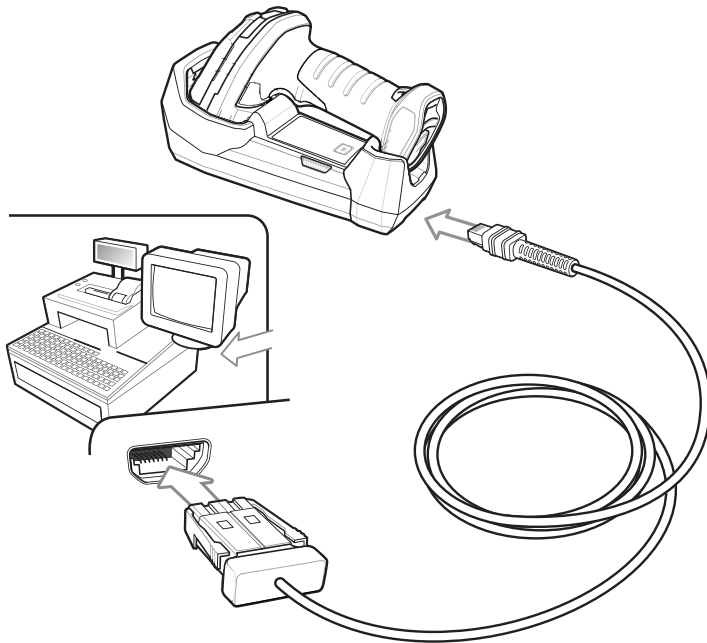

Scan one of the bar codes below

The Auto-Host Detect Cable feature automatically detects the host interface type, but there is no default setting. Scan one of the bar codes below to select the appropriate port.

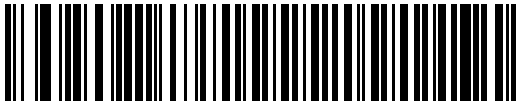

NON-IBM SCANNER EMULATION (PORT 5B)



HAND-HELD SCANNER EMULATION (PORT 9B)

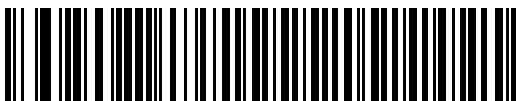

TABLE-TOP SCANNER EMULATION (PORT 17)

Set Defaults Bar Code



RETURN TO FACTORY DEFAULTS

Enter Key Bar Code (Carriage Return/Line Feed)

Add an Enter key after scanned data.

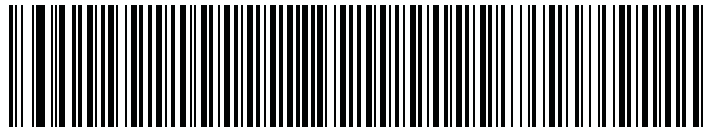

ADD AN ENTER KEY (CARRIAGE RETURN/LINE FEED)

Tab Key Bar Code

Add a Tab key after scanned data.

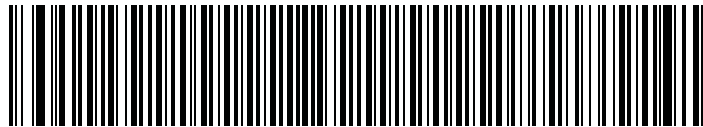

ADD A TAB KEY

USB Caps Lock Override

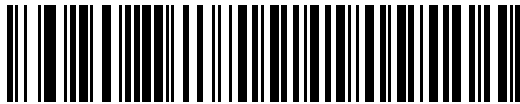

USB - OVERRIDE CAPS LOCK KEY (ENABLE)



*USB - DO NOT OVERRIDE CAPS LOCK KEY (DISABLE)

Aiming



Recommended Usage -Optimum Body Posture

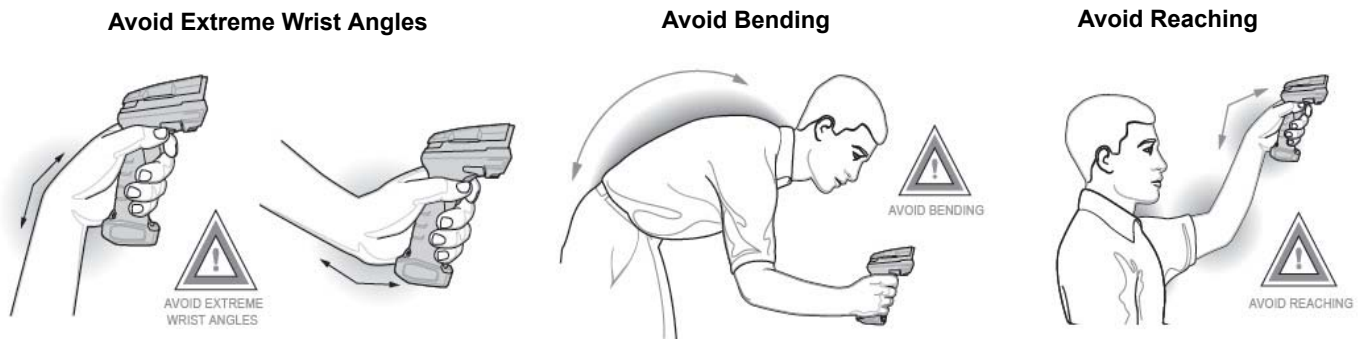

LED Indications

Indication	LED
Hand-Held Scanning	
The scanner is on and ready to scan, or no power to the scanner	Off
A bar code is successfully decoded	Green
Transmission error	Red
Hand-Free (Presentation) Scanning	
No power to the scanner	Off
The scanner is on and ready to scan	Green
A bar code is successfully decoded	Off momentarily
Transmission error	Red

Beeper Indications

Indication	Beeper Sequence
Power up	Low/medium/high beep
A bar code is successfully decoded	Medium beep
Transmission error detected; data is ignored	4 long low beeps
Successful parameter setting	High/low/high/low beep
Correct programming sequence performed	High/low beep
Incorrect programming sequence, or Cancel bar code scanned	Low/high beep



NOTE In addition to the System/Decode LEDs, the LI3678 cordless linear imager scanner has a Radio and Battery LED gauge. Refer to the *LI3678 Product Reference Guide* for detailed information.

Troubleshooting

Problem	Possible Causes	Possible Solutions
Scanner not working.	No power to scanner.	Check system power.
	Scanner is disabled.	Ensure that correct host interface cable is used.
Scanner decoding bar code, but data not transmitting to host.	Host interface not configured properly.	Scan appropriate host parameter bar codes.
	Interface cable is loose.	Ensure all cable connections are secure.
	Invalid ADF rule.	Program the correct ADF rules.
	Scanner not paired to cradle.	Scan cradle pairing bar code.
Scanner not decoding bar code.	Scanner not programmed for bar code type.	Ensure scanner is programmed to read type of bar code being scanned.
	Bar code unreadable.	Ensure bar code is not defaced; try scanning test bar code of same bar code type.
	Distance between scanner and bar code incorrect.	Move scanner closer to, or further from bar code.
Scanned data incorrectly displayed on host.	Host interface not configured properly.	Scan appropriate host parameter bar codes.
	Region improperly configured.	Select appropriate country and language encoding scheme.

123Scan²

123Scan2 is an easy-to-use, PC-based software tool that enables rapid and easy customized setup of a scanner via a bar code or USB cable. For more information, visit: <http://www.zebra.com/123Scan2>.

Regulatory Information

For devices with Symbol, or Symbol Technologies Inc., etc. on the Manufacturing Label and for devices manufactured at Reynosa, or any other Zebra factory facilities:

This device is approved under Zebra Technologies Corporation.

This guide applies to Model Number: LI3678. All Zebra devices are designed to be compliant with rules and regulations in locations they are sold and will be labeled as required. Local language translations are available at the following website: <http://www.zebra.com/support>.

Any changes or modifications to Zebra equipment, not expressly approved by Zebra, could void the user's authority to operate the equipment.



CAUTION Only use Zebra approved and UL Listed accessories, battery packs, and battery chargers.

Do NOT attempt to charge damp/wet mobile computers or batteries. All components must be dry before connecting to an external power source.

Declared maximum operating temperature: FLB3678 50°C / STB3678 40°C

Bluetooth® Wireless Technology

This is an approved Bluetooth® product. For more information or to view the End Product Listing, please visit <https://www.bluetooth.org/tpg/listings.cfm>.

Wireless Device Country Approvals

✓ **NOTE** This section is only applicable to WW/WR/EU configurations.

Regulatory markings subject to certification are applied to the device signifying the radio(s) is/are approved for use in the following countries and continents: United States, Canada, Japan, China, South Korea, Australia, and Europe.

Please refer to the Declaration of Conformity (DoC) for details of other country markings. This is available at: <http://www.zebra.com/doc>.

Note: Europe includes Austria, Belgium, Bulgaria, Croatia, Czech Republic, Cyprus, Denmark, Estonia, Finland, France, Germany, Greece, Hungary, Iceland, Ireland, Italy, Latvia, Liechtenstein, Lithuania, Luxembourg, Malta, Netherlands, Norway, Poland, Portugal, Romania, Slovak Republic, Slovenia, Spain, Sweden, Switzerland, and the United Kingdom.



CAUTION Operation of the device without regulatory approval is illegal.

Health and Safety Recommendations



Ergonomic Recommendations



CAUTION In order to avoid or minimize the potential risk of ergonomic injury follow the recommendations below. Consult with your local Health & Safety Manager to ensure that you are adhering to your company's safety programs to prevent employee injury.

- Reduce or eliminate repetitive motion
- Maintain a natural position
- Reduce or eliminate excessive force
- Keep objects that are used frequently within easy reach
- Perform tasks at correct heights
- Reduce or eliminate vibration
- Reduce or eliminate direct pressure
- Provide adjustable workstations
- Provide adequate clearance
- Provide a suitable working environment
- Improve work procedures.

Warnings for Use of Wireless Devices



CAUTION Please observe all warning notices with regard to the usage of wireless devices.

Safety in Hospitals

Wireless devices transmit radio frequency energy and may affect medical electrical equipment.

Wireless devices should be switched off wherever you are requested to do so in hospitals, clinics or healthcare facilities. These requests are designed to prevent possible interference with sensitive medical equipment.

Pacemakers

Pacemaker manufacturers recommended that a minimum of 15cm (6 inches) be maintained between a hand-held wireless device and a pacemaker to avoid potential interference with the pacemaker. These recommendations are consistent with independent research and recommendations by Wireless Technology Research.

Persons with Pacemakers:

- Should ALWAYS keep the device more than 15cm (6 inches) from their pacemaker when turned ON.
- Should not carry the device in a breast pocket.
- Should use the ear furthest from the pacemaker to minimize the potential for interference.
- If you have any reason to suspect that interference is taking place, turn OFF your device.

Other Medical Devices

Please consult your physician or the manufacturer of the medical device, to determine if the operation of your wireless product may interfere with the medical device.



RF Exposure Guidelines

Safety Information

• **Reducing RF Exposure – Use Properly**

Only operate the device in accordance with the instructions supplied.

• **International**

The device complies with internationally recognized standards covering human exposure to electromagnetic fields from radio devices. For information on “International” human exposure to electromagnetic fields refer to the Zebra Declaration of Conformity (DoC) at <http://www.zebra.com/doc>.

For further information on the safety of RF energy from wireless devices, see

<http://responsibility.zebra.com/index.php/downloads/>, which is located under Wireless Communications and Health.

• **Europe**

• **Handheld Devices**

To comply with EU RF exposure requirements, this device must be operated in the hand with a minimum separation distance of 0 cm or more from a person's body. Other operating configurations should be avoided.

• **US and Canada**

• **Co-located Statement**

To comply with FCC RF exposure compliance requirement, the antenna used for this transmitter must not be co-located or operating in conjunction with any other transmitter/antenna except those already approved in this filling.

• **Handheld Devices**

This device was tested for typical body worn or handheld operation. Use only Zebra tested and approved belt-clips, holsters, and similar accessories to ensure FCC Compliance. The use of third-party belt clips, holsters, and similar accessories may not comply with FCC RF exposure compliance requirements, and should be avoided.



CAUTION To satisfy US and Canadian RF exposure requirements, a transmitting device must operate with a minimum separation distance of 0 cm or more from a person's body.

Pour satisfaire aux exigences Américaines et Canadiennes d'exposition aux radio fréquences, un dispositif de transmission doit fonctionner avec une distance de séparation minimale de 0 cm ou plus de corps d'une personne.

Laser Devices

Class 2 laser scanners use a low power, visible light diode. As with any very bright light source such as the sun, the user should avoid staring directly into the light beam. Momentary exposure to a Class 2 laser is not known to be harmful.

The following statement is required to comply with US and international regulations.



CAUTION Use of controls, adjustments, or the performance of procedures other than those specified herein may result in hazardous laser light exposure.

Scanner Labels

Scanner labels read:

- LASER LIGHT - DO NOT STARE INTO BEAM CLASS 2 LASER PRODUCT.
- COMPLIES WITH 21 CFR1040.10 AND 1040.11 EXCEPT FOR DEVIATIONS PURSUANT TO LASER NOTICE NO. 50, DATED JUNE 24, 2007, AND IEC 60825-1 (Ed.2.0), EN60825-1:2007.

LED Devices

For LED devices which have been evaluated to IEC 62471 and comply with the Exempt Risk Group, no product labeling requirements apply. However, the following statement is required to comply with US and international regulations:

LED Compliance Statement: Classified as 'EXEMPT RISK GROUP' according to IEC 62471:2006 and EN 62471:2008. Pulse duration: Continuous mS.

Scanner Labeling

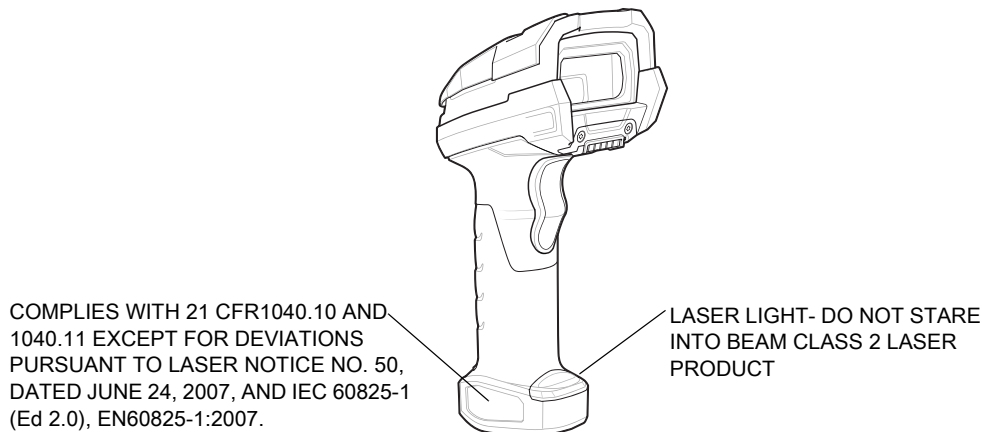

Batteries

Taiwan - Recycling

EPA (Environmental Protection Administration) requires dry battery producing or importing firms in accordance with Article 15 of the Waste Disposal Act are required to indicate the recycling marks on the batteries used in sales, giveaway, or promotion. Contact a qualified Taiwanese recycler for proper battery disposal.

Battery Information



CAUTION Risk of explosion if battery is replaced by an incorrect type. Dispose of batteries according to instructions.

Use only Zebra approved batteries. Accessories which have battery charging capability are approved for use with the following battery models: Part Number 82-166537-01 (3.6 Vdc, 3200 mAh).

Zebra approved rechargeable battery packs are designed and constructed to the highest standards within the industry.

However, there are limitations as to how long a battery can operate or be stored before needing replacement. Many factors affect the actual life cycle of a battery pack such as heat, cold, harsh environmental conditions, and severe drops.

When batteries are stored over six months, some irreversible deterioration in overall battery quality may occur. Store batteries at half of full charge in a dry, cool place, removed from the equipment to prevent loss of capacity, rusting of metallic parts, and electrolyte leakage. When storing batteries for one year or longer, the charge level should be verified at least once a year and charged to half of full charge.

Replace the battery when a significant loss of run time is detected.

Standard warranty period for all Zebra batteries is 30 days, regardless if the battery was purchased separately or included as part of the mobile computer or bar code scanner. For more information on Zebra batteries, please visit:

<http://www.zebra.com/batterybasics>.

Battery Safety Guidelines

The area in which the units are charged should be clear of debris and combustible materials or chemicals. Particular care should be taken where the device is charged in a non-commercial environment.

- Follow battery usage, storage, and charging guidelines found in the user's guide.
- Improper battery use may result in a fire, explosion, or other hazard.
- To charge the mobile device battery, the battery and charger temperatures must be between +32 °F and +104 °F (0 °C and +40 °C).
- Do not use incompatible batteries and chargers. Use of an incompatible battery or charger may present a risk of fire, explosion, leakage, or other hazard. If you have any questions about the compatibility of a battery or a charger, contact Zebra support.
- For devices that utilize a USB port as a charging source, the device shall only be connected to products that bear the USB-IF logo or have completed the USB-IF compliance program.
- Do not disassemble or open, crush, bend or deform, puncture, or shred.
- Severe impact from dropping any battery-operated device on a hard surface could cause the battery to overheat.
- Do not short circuit a battery or allow metallic or conductive objects to contact the battery terminals.
- Do not modify or remanufacture, attempt to insert foreign objects into the battery, immerse or expose to water or other liquids, or expose to fire, explosion, or other hazard.
- Do not leave or store the equipment in or near areas that might get very hot, such as in a parked vehicle or near a radiator or other heat source. Do not place battery into a microwave oven or dryer.
- Battery usage by children should be supervised.
- Please follow local regulations to promptly dispose of used re-chargeable batteries.
- Do not dispose of batteries in fire.
- Seek medical advice immediately if a battery has been swallowed.
- In the event of a battery leak, do not allow the liquid to come in contact with the skin or eyes. If contact has been made, wash the affected area with large amounts of water and seek medical advice.
- If you suspect damage to your equipment or battery, contact Zebra support to arrange for inspection.

Radio Frequency Interference Requirements - FCC



Note: This equipment has been tested and found to comply with the limits for a Class B digital device, pursuant to Part 15 of the FCC rules. These limits are designed to provide reasonable protection against harmful interference in a residential installation.

This equipment generates, uses and can radiate radio frequency energy and, if not installed and used in accordance with the instructions, may cause harmful interference to radio communications. However there is no guarantee that interference will not occur in a particular installation. If this equipment does cause harmful interference to radio or television reception, which can be determined by turning the equipment off and on, the user is encouraged to try to correct the interference by one or more of the following measures:

- Reorient or relocate the receiving antenna
- Increase the separation between the equipment and receiver
- Connect the equipment into an outlet on a circuit different from that to which the receiver is connected
- Consult the dealer or an experienced radio/TV technician for help.

Radio Transmitters (Part 15)

This device complies with Part 15 of the FCC Rules. Operation is subject to the following two conditions: (1) this device may not cause harmful interference, and (2) this device must accept any interference received including interference that may cause undesired operation. The use of 5 GHz WLAN's, for use in the US, have the following restrictions

Radio Frequency Interference Requirements- Canada

CAN ICES-3 (B)/NMB-2(B)

Radio Transmitters

This device complies with Industry Canada's licence-exempt RSSs. Operation is subject to the following two conditions:

(1) This device may not cause interference; and (2) This device must accept any interference, including interference that may cause undesired operation of the device.

Cet appareil est conforme exempts de licence le flux RSS de Industrie Canada. Son fonctionnement est soumis aux deux conditions suivantes:

(1) Ce dispositif ne peut causer des interférences; et (2) Cet appareil doit accepter toute interférence, y compris les interférences qui peuvent causer un mauvais fonctionnement de l'appareil.

Marking and European Economic Area (EEA)

Bluetooth® Wireless Technology for use through the EEA has the following restrictions:

- Maximum radiated transmit power of 100mW EIRP in the frequency range 2.400 -2.4835 GHz.

Statement of Compliance

Zebra hereby declares that this device is in compliance with the essential requirements and other relevant provisions of Directive 1999/5/EC and 2011/65/EU. A Declaration of Conformity may be obtained from <http://www.zebra.com/doc>.

Other Countries

Brazil (UNWANTED EMISSIONS - ALL PRODUCTS)

Regulatory declarations for LI3678 - BRAZIL

For more information consult the website www.anatel.gov.br

Declarações Regulamentares para LI3678 - Brazil

- ✓ **NOTE** A marca de certificação se aplica ao Transceptor, modelo LI-3678. Este equipamento opera em caráter secundário, isto é, não tem direito a proteção contra interferência prejudicial, mesmo de estações do mesmo tipo, e não pode causar interferência a sistemas operando em caráter primário.

Para maiores informações sobre ANATEL consulte o site: www.anatel.gov.br

Japan (VCCI) - Voluntary Control Council for Interference

Class B ITE

この装置は、情報処理装置等電波障害自主規制協議会（VCCI）の基準に基づくクラスB情報技術装置です。この装置は、家庭環境で使用することを目的としていますが、この装置がラジオやテレビジョン受信機に近接して使用されると、受信障害を引き起こすことがあります。取扱説明書に従って正しい取り扱いをして下さい。

Korea Warning Statement for Class B ITE

기종별	사용자안내문
B급 기기 (가정용 방송통신기기)	이 기기는 가정용(B급)으로 전자파적합등록을 한 기기로서 주로 가정에서 사용하는 것을 목적으로 하며, 모든 지역에서 사용할 수 있습니다.

Chile

Este equipo cumple con la Resolución No 403 de 2008, de la Subsecretaria de telecomunicaciones, relativa a radiaciones electromagnéticas.

China

通过访问以下网址可下载当地语言支持的产品说明书

<http://www.zebra.com/contact>



Taiwan

臺灣

低功率電波輻射性電機管理辦法

第十二條

經型式認證合格之低功率射頻電機，非經許可，公司、商號或使用者均不得擅自變更頻率、加大功率或變更原設計之特性及功能。

第十四條

低功率射頻電機之使用不得影響飛航安全及干擾合法通信；經發現有干擾現象時，應立即停用，並改善至無干擾時方得繼續使用。

前項合法通信，指依電信規定作業之無線電通信。

低功率射頻電機須忍受合法通信或工業、科學及醫療用電波輻射性電機設備之干擾。

South Korea

For a radio equipment using 2400~2483.5MHz or 5725~5825MHz, the following two expression should be displayed:

당해 무선설비는 운용 중 전파혼신 가능성이 있음

당해 무선설비는 전파혼신 가능성이 있으므로 인명안전과 관련된 서비스는 할 수 없습니다.

Ukraine

Дане обладнання відповідає вимогам технічного регламенту №1057, № 2008 на обмеження щодо використання деяких небезпечних речовин в електричних та електронних пристроях.

Thailand

เครื่องโทรคมนาคมและอุปกรณ์นี้ มีความสอดคล้องตามข้อกำหนดของ กทท.



Waste Electrical and Electronic Equipment (WEEE)

Bulgarish: За клиенти от ЕС: След края на полезния им живот всички продукти трябва да се връщат на Zebra за рециклиране. За информацията относно връщането на продукти, моля отидете на адрес <http://www.zebra.com/weee>.

Čeština: Pro zákazníky z EU: Všechny produkty je nutné po skončení jejich životnosti vrátit společnosti Zebra k recyklaci. Informace o způsobu vrácení produktu najdete na webové stránce: <http://www.zebra.com/recycling/weee>.

Dansk: Til kunder i EU: Alle produkter skal returneres til Zebra til recirkulering, når de er udtjent. Læs oplysningerne om returnering af produkter på: <http://www.zebra.com/recycling/weee>.

Deutsch: Für Kunden innerhalb der EU: Alle Produkte müssen am Ende ihrer Lebensdauer zum Recycling an Zebra zurückgesandt werden. Informationen zur Rücksendung von Produkten finden Sie unter <http://www.zebra.com/recycling/weee>.

Ελληνικά: Για πελάτες στην Ε.Ε.: Όλα τα προϊόντα, στο τέλος της διάρκειας ζωής τους, πρέπει να επιστράφονται στην Zebra για ανακύκλωση. Για περισσότερες πληροφορίες σχετικά με την επιστροφή ενός προϊόντος, επισκεφθείτε τη διεύθυνση <http://www.zebra.com/recycling/weee> στο Διαδίκτυο.

English: For EU Customers: All products at the end of their life must be returned to Zebra for recycling. For information on how to return product, please go to: <http://www.zebra.com/recycling/weee>.

Español: Para clientes en la Unión Europea: todos los productos deberán entregarse a Zebra al final de su ciclo de vida para que sean reciclados. Si desea más información sobre cómo devolver un producto, visite: <http://www.zebra.com/recycling/weee>.

Eesti: EL klientidele: kõik tooted tuleb nende eluea lõppedes tagastada taaskasutamise eesmärgil Zebra'ile. Lisainformatsiooni saamiseks toote tagastamise kohta külastage palun aadressi: <http://www.zebra.com/recycling/weee>.

Suomi: Asiakkait Euroopan unionin alueella: Kaikki tuotteet on palautettava kierrätettäväksi Zebra-yhtiöön, kun tuotetta ei enää käytetä. Lisätietoja tuotteen palauttamisesta on osoitteessa <http://www.zebra.com/recycling/weee>.

Français : Clients de l'Union Européenne : Tous les produits en fin de cycle de vie doivent être retournés à Zebra pour recyclage. Pour de plus amples informations sur le retour de produits, consultez : <http://www.zebra.com/recycling/weee>.

Magyar: Az EU-ban vásárlóknak: Minden tönkrement terméket a Zebra vállalathoz kell eljuttatni újrahasznosítás céljából. A termék visszajuttatásának módjával kapcsolatos tudnivalóért látogasson el a <http://www.zebra.com/recycling/weee>.

Italiano: per i clienti dell'UE: tutti i prodotti che sono giunti al termine del rispettivo ciclo di vita devono essere restituiti a Zebra al fine di consentire il riciclaggio. Per informazioni sulle modalità di restituzione, visitare il seguente sito Web: <http://www.zebra.com/recycling/weee>.

Lietuvių: ES vartotojams: visi gaminiai, pasibaigus jų eksploatacijos laikui, turi būti gražinti utilizuoti į kompaniją „Zebra“. Daugiau informacijos, kaip gražinti gaminį, rasite: <http://www.zebra.com/recycling/weee>.

Latviešu: ES klientiem: visi produkti pēc to kalpošanas mūža beigām ir jānogādā atpakaļ Zebra otrreizējai pārstrādei. Lai iegūtu informāciju par produktu nogādāšanu Zebra, lūdzu, skatiet: <http://www.zebra.com/recycling/weee>.

Malti: Għal klijenti fl-UE: il-prodotti kollha li jkunu waslu fl-aħħar tal-ħajja ta' l-użu tagħhom, iridu jiġu rritornati għand Zebra għar-riċiklaġġ. Għal aktar tagħrif dwar kif għandek tirritorna l-prodott, jekk jogħġbok żur: <http://www.zebra.com/recycling/weee>.

Nederlands: Voor klanten in de EU: alle producten dienen aan het einde van hun levensduur naar Zebra te worden teruggezonden voor recycling. Raadpleeg <http://www.zebra.com/recycling/weee> voor meer informatie over het terugzenden van producten.

Polski: Klienci z obszaru Unii Europejskiej: Produkty wycofane z eksploatacji należy zwrócić do firmy Zebra w celu ich utylizacji. Informacje na temat zwrotu produktów znajdują się na stronie internetowej <http://www.zebra.com/recycling/weee>.

Português: Para clientes da UE: todos os produtos no fim de vida devem ser devolvidos à Zebra para reciclagem. Para obter informações sobre como devolver o produto, visite: <http://www.zebra.com/recycling/weee>.

Românesc: Pentru clienții din UE: Toate produsele, la sfârșitul duratei lor de funcționare, trebuie returnate la Zebra pentru reciclare. Pentru informații despre returnarea produsului, accesați: <http://www.zebra.com/recycling/weee>.

Slovenčina: Pre zákazníkov z krajín EU: Všetky výrobky musia byť po uplynutí doby ich životnosti vrátené spoločnosti Zebra na recykláciu. Bližšie informácie o vrátení výrobkov nájdete na: <http://www.zebra.com/recycling/weee>.

Slovenski: Za kupce v EU: vsi izdelki se morajo po poteku življenjske dobe vrniti podjetju Zebra za reciklažo. Za informacije o vračilu izdelka obiščite: <http://www.zebra.com/recycling/weee>.

Svenska: För kunder inom EU: Alla produkter som uppnått sin livslängd måste returneras till Zebra för återvinning. Information om hur du returnerar produkten finns på <http://www.zebra.com/recycling/weee>.

Türkçe: AB Müşterileri için: Kullanım süresi dolan tüm ürünler geri dönüşürme için Zebra'ya iade edilmelidir. Ürünlerin nasıl iade edileceği hakkında bilgi için lütfen şu adresi ziyaret edin: <http://www.zebra.com/recycling/weee>.

TURKISH WEEE Statement of Compliance

EEE Yönetmeliğine Uygundur

China RoHS

This table was created to comply with China RoHS requirements.

部件名称 (Parts)	有害物质 					
	铅 (Pb)	汞 (Hg)	镉 (Cd)	六价铬 (Cr (VI))	多溴联苯 (PBB)	多溴二苯醚 (PBDE)
金属部件 (Metal Parts)	X	○	○	○	○	○
电路模块 (Circuit Modules)	X	○	○	○	○	○
电缆及电缆组件 (Cables and Cable Assemblies)	○	○	○	○	○	○
塑料和聚合物部件 (Plastic and Polymeric Parts)	○	○	○	○	○	○
光学和光学组件 (Optics and Optical Components)	X	○	○	○	○	○
电池 (Batteries)	○	○	○	○	○	○

本表格依据SJ/T 11364 的规定编制。

- 0: 表示该有害物质在该部件所有均质材料中的含量均在 SJ/T 11364—2014 规定的限量要求以下。
 X: 表示该有害物质至少在该部件的某一均质材料中的含量超出 SJ/T 11364—2014 规定的限量要求。(企业可在此处, 根据实际情况对上表中打“×”的技术原因进行进一步说明。)

This table was created to comply with China RoHS requirements.



Zebra Technologies Corporation
Lincolnshire, IL U.S.A.
<http://www.zebra.com>

Zebra and the stylized Zebra head are trademarks of ZIH Corp., registered in many jurisdictions worldwide. All other trademarks are the property of their respective owners.

©2016 Symbol Technologies LLC, a subsidiary of Zebra Technologies Corporation. All rights reserved.



MN002323A01EN Revision A - April 2016

