

RFD5500 RFID Sled

User Guide

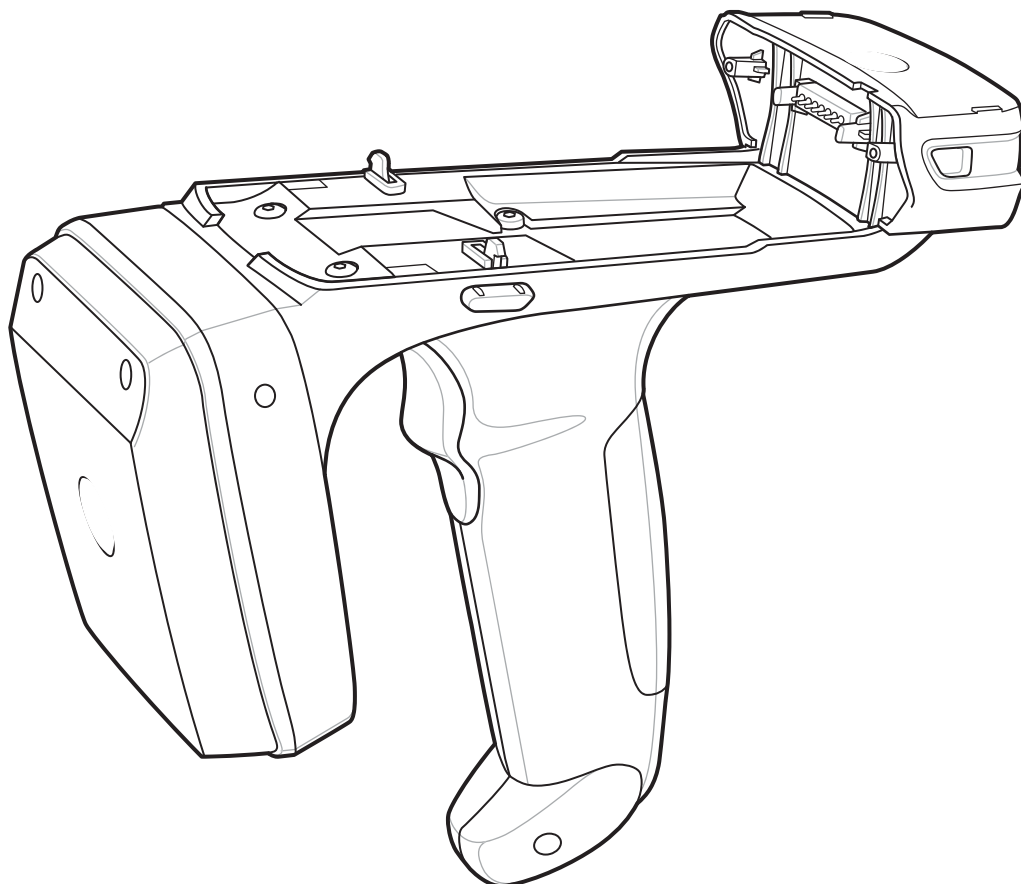

***RFD5500 RFID Sled
User Guide***

MN000077A04

Revision A

March 2015

© 2015 Symbol Technologies, Inc.

No part of this publication may be reproduced or used in any form, or by any electrical or mechanical means, without permission in writing from Zebra. This includes electronic or mechanical means, such as photocopying, recording, or information storage and retrieval systems. The material in this manual is subject to change without notice.

The software is provided strictly on an “as is” basis. All software, including firmware, furnished to the user is on a licensed basis. Zebra grants to the user a non-transferable and non-exclusive license to use each software or firmware program delivered hereunder (licensed program). Except as noted below, such license may not be assigned, sublicensed, or otherwise transferred by the user without prior written consent of Zebra. No right to copy a licensed program in whole or in part is granted, except as permitted under copyright law. The user shall not modify, merge, or incorporate any form or portion of a licensed program with other program material, create a derivative work from a licensed program, or use a licensed program in a network without written permission from Zebra. The user agrees to maintain Zebra’s copyright notice on the licensed programs delivered hereunder, and to include the same on any authorized copies it makes, in whole or in part. The user agrees not to decompile, disassemble, decode, or reverse engineer any licensed program delivered to the user or any portion thereof.

Zebra reserves the right to make changes to any software or product to improve reliability, function, or design.

Zebra does not assume any product liability arising out of, or in connection with, the application or use of any product, circuit, or application described herein.

No license is granted, either expressly or by implication, estoppel, or otherwise under any Zebra Technologies Corporation, intellectual property rights. An implied license only exists for equipment, circuits, and subsystems contained in Zebra products.

Zebra and the Zebra head graphic are registered trademarks of ZIH Corp. The Symbol logo is a registered trademark of Symbol Technologies, Inc., a Zebra Technologies company.

Zebra Technologies Corporation
Lincolnshire, IL U.S.A.
<http://www.zebra.com>

Warranty

For the complete Zebra hardware product warranty statement, go to:
<http://www.zebra.com/warranty>.

Revision History

Changes to the original manual are listed below:

Change	Date	Description
-01 Rev A	7/2013	Initial release
-02 Rev A	12/2013	Add: MC65 to related documentation, ActiveSync RNDIS, initial sled removal error notification instruction.
-03 Rev A	5/2014	Add: Single slot cradle required part number.
-04 Rev A	3/2015	Zebra Re-Branding

Table of Contents

Warranty	ii
Revision History	iii

Table of Contents

About This Guide

Introduction	ix
Chapter Descriptions	ix
Notational Conventions.....	x
Related Documents and Software	x
Service Information.....	xi

Chapter 1: Getting Started

Introduction	1-1
RFID Technology Overview	1-1
RFID Components	1-2
RFID Sled Features	1-3
LED Definitions	1-4
RFID Sled Battery Installation	1-5
Attach Mobile Computer to RFID Sled	1-6
RFID Sled Charging and Communication	1-7
Charging and Communication	1-7
Mobile Device Features	1-8

Chapter 2: MobileRFID Functionality

Introduction	2-1
Installing a microSD Card	2-2
Enabling RFID on the Mobile Computer	2-3
MobileRFID Icons	2-3
MobileRFID Settings Menu	2-4

Combined Firmware Loader	2-5
Combined Firmware Preparation	2-6
Performing an Update	2-7
Combined Firmware Troubleshooting	2-9
ETSI Channel Selector	2-10
ETSI Channel Selector Application	2-10
ETSI Channel Selector Troubleshooting	2-12
RFID Region Configuration	2-13
Region Configuration Operation	2-13
Configuring Region by Country	2-15
MobileRFID Client Mode	2-18
MobileRFID Version Information	2-19
MobileRFID Run/Stop RFID	2-20

Chapter 3: RFID Sample Application

Introduction	3-1
RFID Sample Application	3-2
Capabilities	3-4
Configuration Menu Options	3-5
Tag Storage Settings	3-5
Antenna	3-6
RF Mode	3-7
Singulation	3-8
Reset to Factory Default	3-8
Operations Menu Options	3-9
Antenna Info	3-9
Filter	3-10
Access	3-13
Triggers	3-18
Management Menu Options	3-23
Help Menu	3-23
Exit	3-23
RapidRead Introduction	4-1
RapidRead Options	4-1

Chapter 4: RapidRead Sample Application

RapidRead Tag File	4-3
Using RapidRead	4-4
RapidRead Lite	4-5
Summary Screen	4-5
Detail Screen	4-6
RapidRead Full	4-7
Summary Screen	4-7
Detail Screen	4-8
Gieger Counter	4-9

RapidRead Scan	4-11
Summary Screen	4-11
Detail Screen	4-12
RapidRead Write	4-13

Chapter 5: Tag Locator

Introduction	5-1
Using Tag Locator	5-2
Locating Tags via .csv File	5-4

Chapter 6: Programming for RFD5500

Programming	6-1
-------------------	-----

Chapter 7: Maintenance and Troubleshooting

Introduction	7-1
Cleaning	7-1
Approved Cleanser Active Ingredients	7-1
Harmful Ingredients	7-1
Cleaning Instructions	7-2
Special Cleaning Notes	7-2
Materials Required	7-2
Cleaning Cradle Connectors	7-2
Cleaning Frequency	7-3
Maintenance	7-3
RFD5500	7-3
Battery	7-3
ActiveSync RNDIS	7-4
Initial Sled Removal Error Notification	7-5
Troubleshooting	7-6
Single Slot USB Cradle	7-6
Cables	7-8

Index

About This Guide

Introduction

The *RFD5500 RFID Sled User Guide* provides general instructions for using the RFID Sled.

Chapter Descriptions

Topics covered in this guide are as follows:

- *Chapter 1, Getting Started* provides an overview of RFID technology, components of the RFID Sled and sample Mobile Computer features.
- *Chapter 2, MobileRFID Functionality* describes how to install and configure MobileRFID.
- *Chapter 3, RFID Sample Application* provides information on the RFID sample application and how to use it to assist in custom application development.
- *Chapter 4, RapidRead Sample Application* provides information on the RapidRead RFID reader application used to demonstrate inventory and asset counting, tag writing and item locating.
- *Chapter 5, Tag Locator* provides information on the application used to detect the location of a tag.
- *Chapter 6, Programming for RFD5500* describes the primary programming interface and instruction on how to obtain additional information.
- *Chapter 7, Maintenance and Troubleshooting* describes cleaning, maintenance and troubleshooting procedures.

Notational Conventions

The following conventions are used in this document:

- “RFID Sled” refers to the RFD5500 RFID Sled.
- *Italics* are used to highlight the following:
 - Chapters and sections in this and related documents
 - Dialog box, window, links, software names, and screen names
 - Drop-down list, columns and list box names
 - Check box and radio button names
 - Icons on a screen
- **Bold** text is used to highlight the following:
 - Key names on a keypad
 - Button names on a screen
- Bullets (•) indicate:
 - Action items
 - Lists of alternatives
 - Lists of required steps that are not necessarily sequential
- Sequential lists (e.g., those that describe step-by-step procedures) appear as numbered lists.

Related Documents and Software

The following documents provide more information about the reader.

- *RFD5500 Regulatory Guide*, p/n 72-165189-xx.
- *RFD5500 Quick Start Guide*, p/n 72-164131-xx.
- *MC55 User Guide*, p/n 72E-108859-xx.
- *MC55 Integrator Guide*, p/n 72E-108861-xx.
- *MC65 User Guide*, p/n 72E-133769-xx.
- *MC65 Integrator Guide*, p/n 72E-142435-xx.

For the latest version of this guide and all guides, go to: <http://www.zebra.com/support>.

Service Information

Before you use the unit, it must be configured to operate with your mobile device to run your applications. If you have a problem running your unit or using your equipment, contact your facility's Technical or Systems Support. If there is a problem with the equipment, they will contact the Zebra Support Center.

Contact information is available at: <http://www.zebra.com/support>.

When contacting Zebra support, please have the following information available:

- Serial number of the unit
- Model number or product name
- Software type and version number.

Zebra responds to calls by e-mail, telephone or fax within the time limits set forth in service agreements.

If your problem cannot be solved by Zebra support, you may need to return your equipment for servicing and will be given specific directions. Zebra is not responsible for any damages incurred during shipment if the approved shipping container is not used. Shipping the units improperly can possibly void the warranty.

If you purchased your business product from a Zebra business partner, please contact that business partner for support.

Chapter 1 Getting Started

Introduction

This chapter provides an overview of RFID technology and components, and explains how to set up the mobile device for the first time

RFID Technology Overview

RFID (Radio Frequency Identification) is an advanced automatic identification (Auto ID) technology that uses radio frequency signals to identify *tagged* items. An RFID tag contains a circuit that can store data. This data may be pre-encoded or can be encoded in the field. The tags come in a variety of shapes and sizes.

To read a tag the mobile computer sends out radio frequency waves using its integrated antenna. This RF field powers and charges the tags, which are tuned to receive radio waves. The tags use this power to modulate the carrier signal. The reader interprets the modulated signal and converts the data to a format for computer storage. The computer application translates the data into an understandable format.

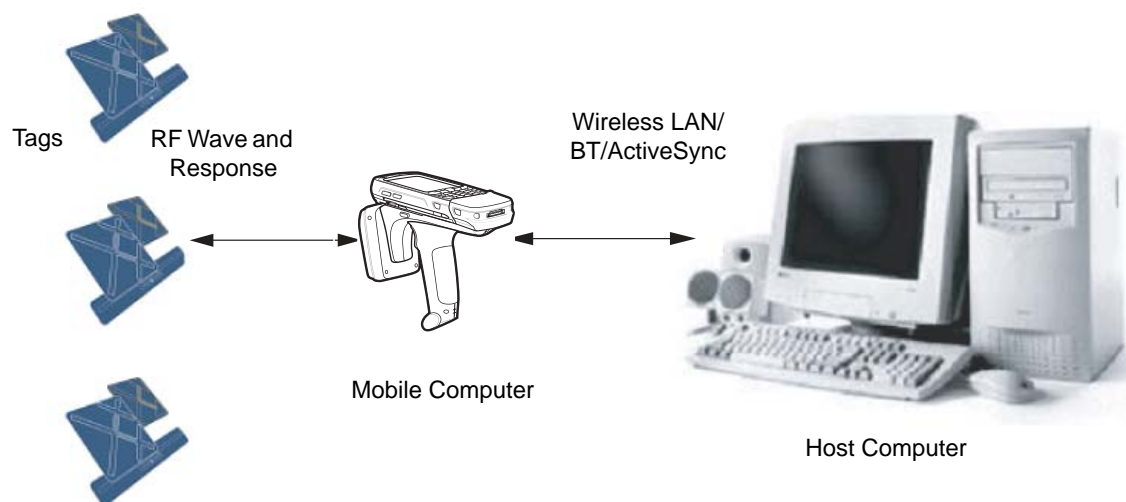

Figure 1-1 RFID System Elements

RFID Components

Zebra RFID solutions offer low cost, long read range, and a high read rate. These features provide real time end-to-end visibility of products and assets in the factory, distribution center, retail outlet, or other facility. The RFID system consists of the following components:

- Silicon-based RFID tags that attach to retail products, vehicles, trailers, containers, pallets, boxes, etc.
- An integrated antenna that supports applications such as item level tracking and asset tracking.
- An embedded radio module that powers and communicates with tags for data capture and provides host connectivity for data migration.

Tags

Tags contain embedded chips that store unique information. Available in various shapes and sizes, tags, often called *transponders*, receive and respond to data requests. Tags require power to send data.

There are several categories of tags based on the protocol they support, read/write memory, and power options:

- Active RFID tags are powered by internal light-weight batteries, and also use these batteries to broadcast radio waves to the reader.
- Semi-passive RFID tags are also powered by internal light-weight batteries, but draw broadcasting power from the reader.
- Passive RFID tags are powered by a reader-generated RF field. These tags are much lighter and less expensive than active tags, and are typically applied to less expensive goods.

Antenna

Antennas transmit and receive radio frequency signals.

Radio Module

The radio module communicates with the tags and transfers the data to a host computer. It also provides features such as filtering, CRC check, and tag writing. The RFID mobile computers supports standard RFID tags as described by EPCGlobal™ Class 1 Gen2 protocol.

RFID Sled Features

The RFD5500 RFID Sled adds a RFID gun-style handle with a scanning trigger to the mobile computer. Used for all RFID operations, the RFD5500 increases comfort when using the mobile computer in scan-intensive applications for extended periods of time.

Left View

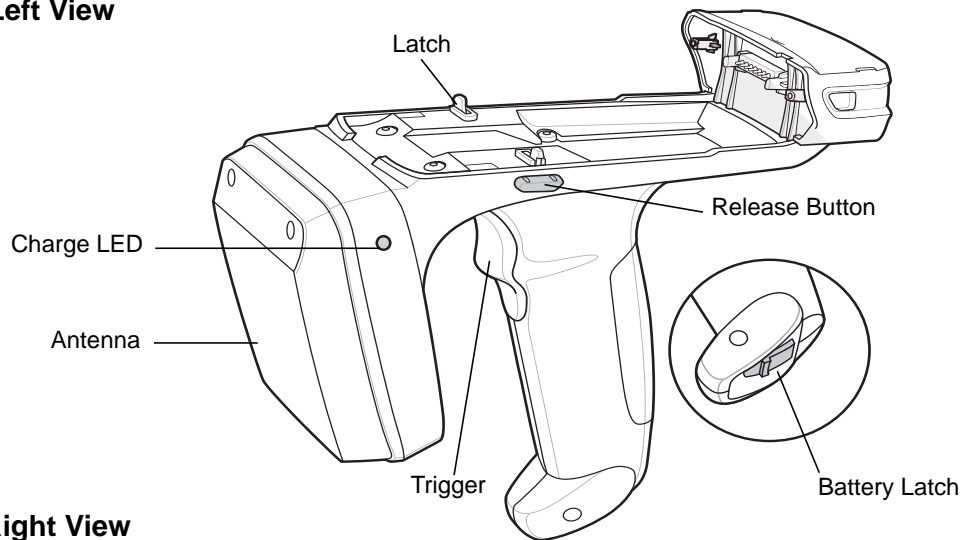

Right View

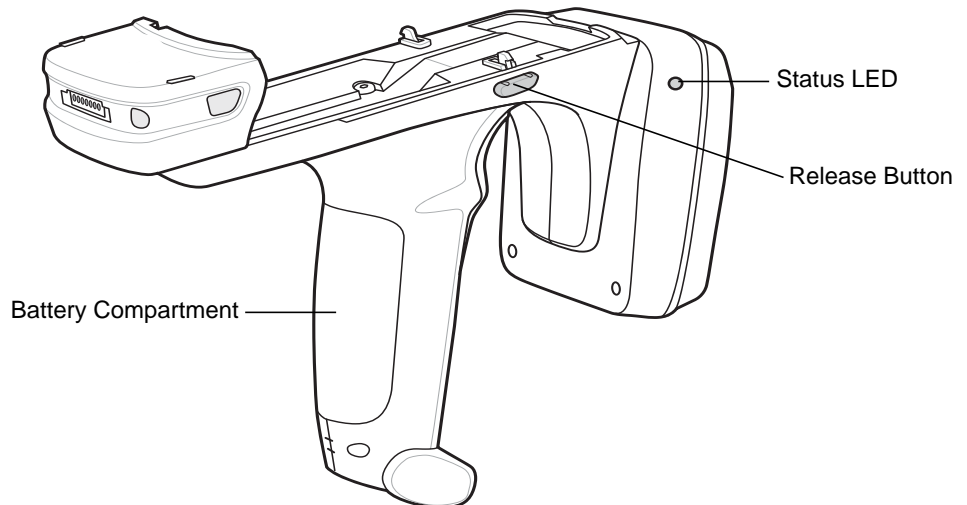

Figure 1-2 RFD5500 RFID Sled Features

LED Definitions

The RFD5500 uses a two-color LED to indicate status.

LED	Indication
Status	
Solid Green	Ready to read RFID tags.
Slow Blinking Green	Region code not configured.
Off	No power is applied to the device.
Charging LED	
Solid Amber	Sled battery is fully charged.
Slow Blinking Amber	Sled battery is charging.
Off	No power is applied to the device.

Table 1-1 RFD5500 LED Definitions

RFID Sled Battery Installation

To install the battery:

1. Insert the battery, connector end first, into the battery compartment.
2. Press down on the battery until the battery latch snaps into place.

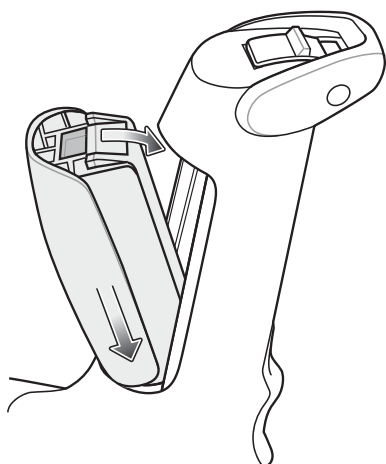

Figure 1-3 *RFID Sled Battery Insertion*

To remove the battery:

1. Open battery latch on bottom of RFID Sled handle.
2. Remove battery.



Figure 1-4 *RFID Sled Battery Removal*

Attach Mobile Computer to RFID Sled

To insert the Mobile Computer into the RFID Sled, slide the mobile computer into the RFID Sled until it locks in place. The latches secure the mobile computer to the RFID Sled.

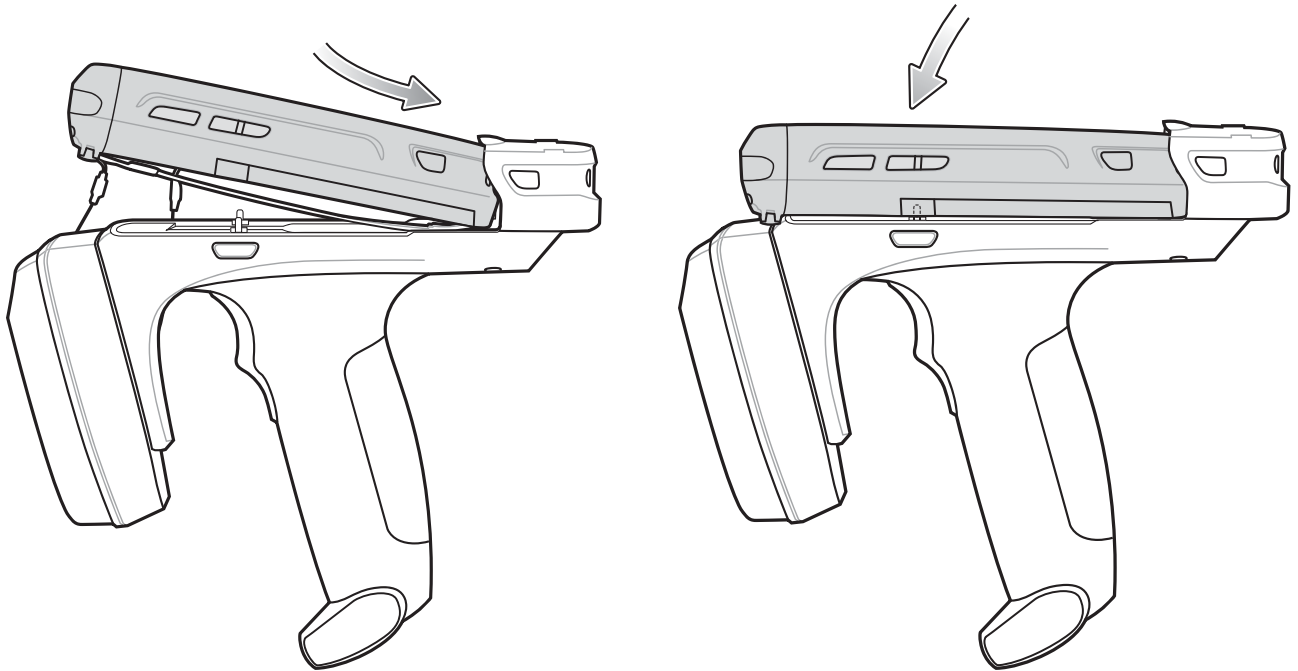

Figure 1-5 *Insert Mobile Computer into RFID Sled*

To remove the mobile computer, press the release buttons and pull the mobile computer forward and up.

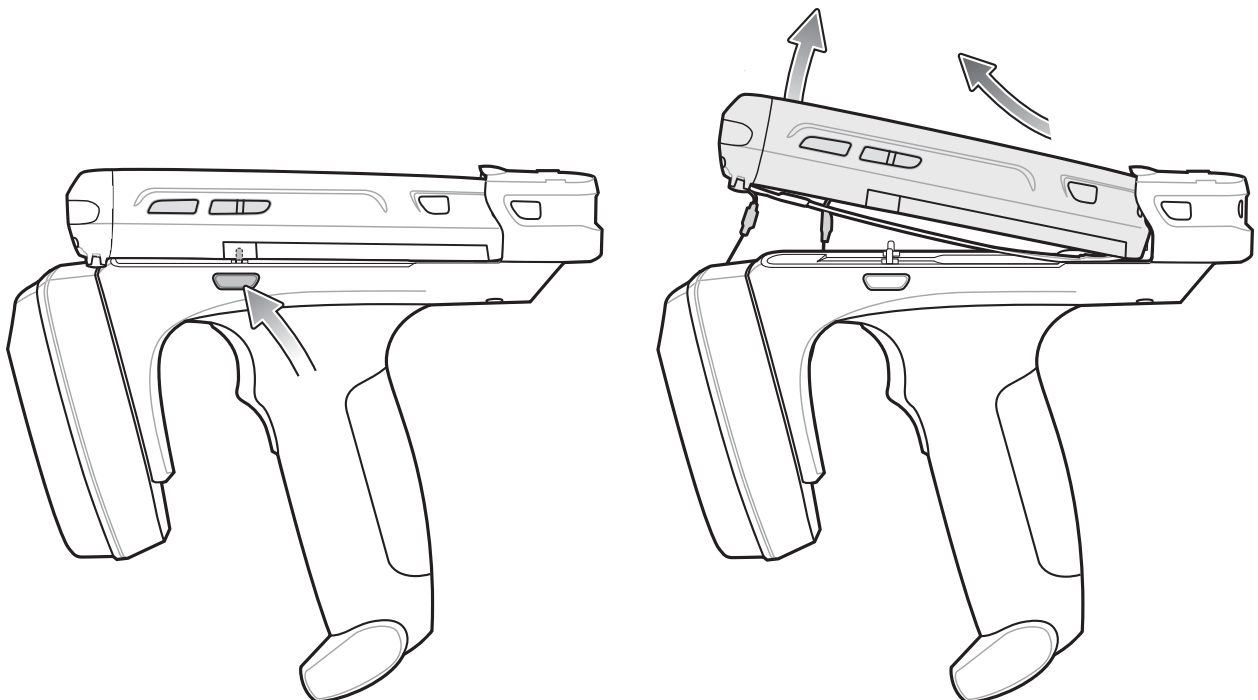

Figure 1-6 *Remove Mobile Computer from RFID Sled*

RFID Sled Charging and Communication

Charging and Communication

The RFID Sled can be used to charge the battery of a mobile computer, and communicate with a host computer. The recommended form of communication to the mobile computer is via USB charge/communication cable.

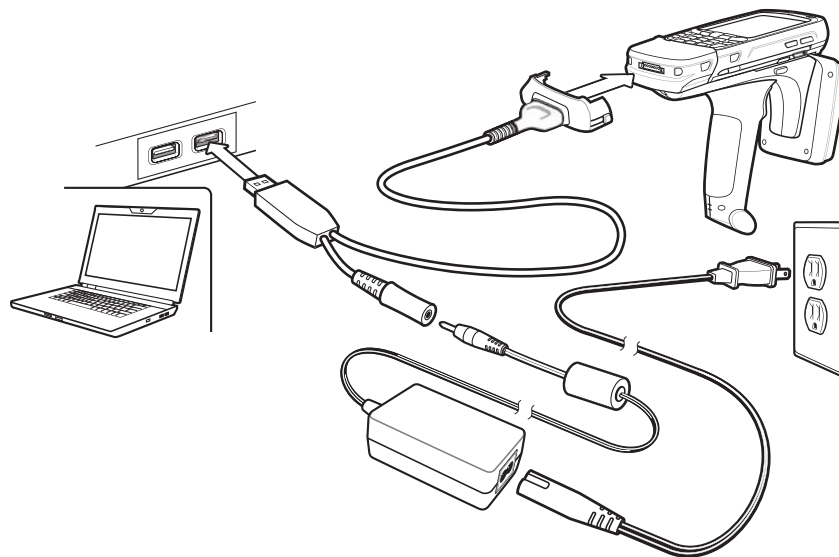

Figure 1-7 *Charging and Communication*

Mobile Device Features

✓ **NOTE** Images and screens pictured in this guide are samples and may differ from actual screens.

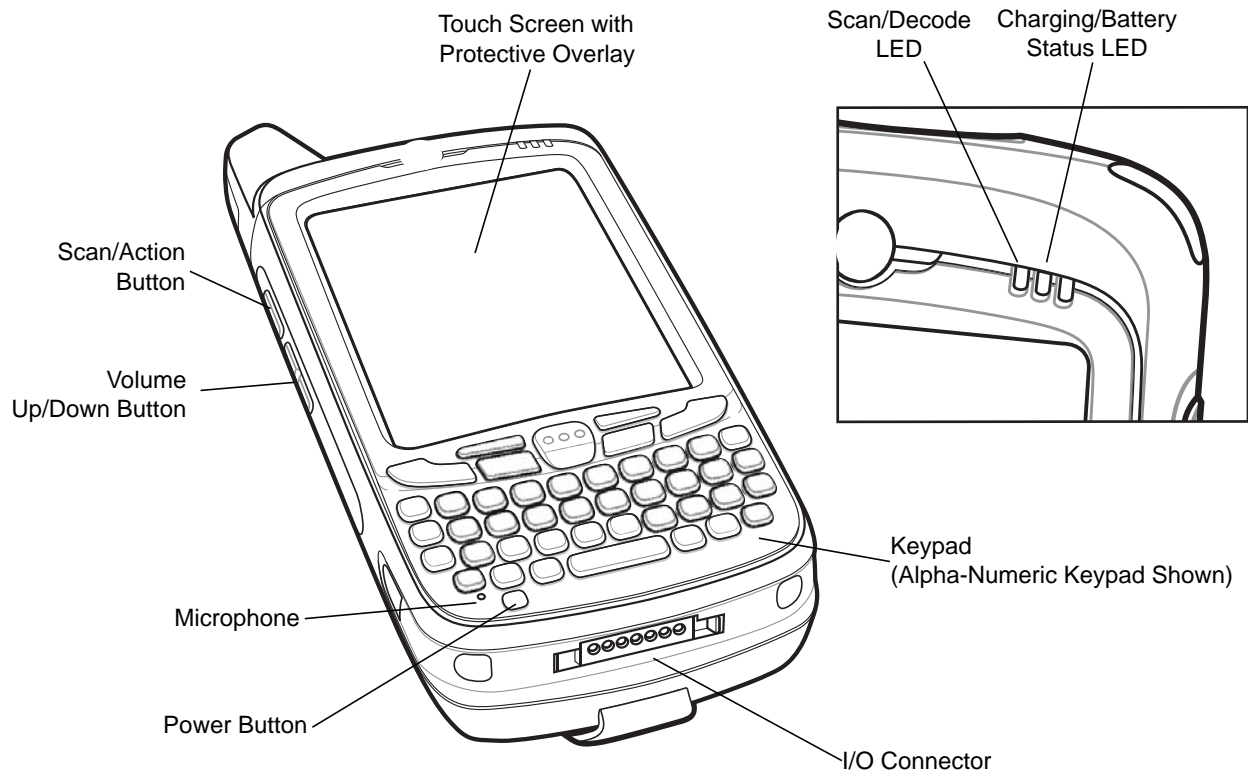

Figure 1-8 Sample of Mobile Computer Front View

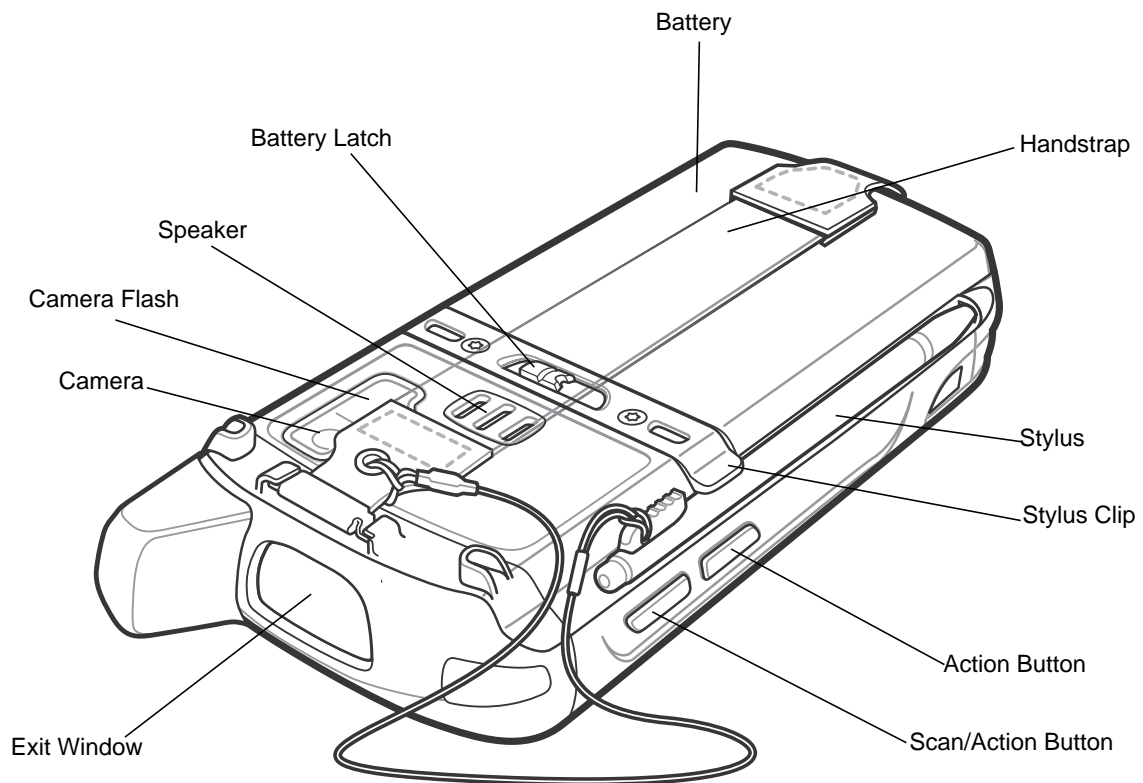

Figure 1-9 *Sample of Mobile Computer Rear View*

Chapter 2 MobileRFID Functionality

Introduction

MobileRFID is an RFID server application that runs in the background of the mobile computer. The MobileRFID icon appears on the screen. This chapter includes information on using and configuring MobileRFID.

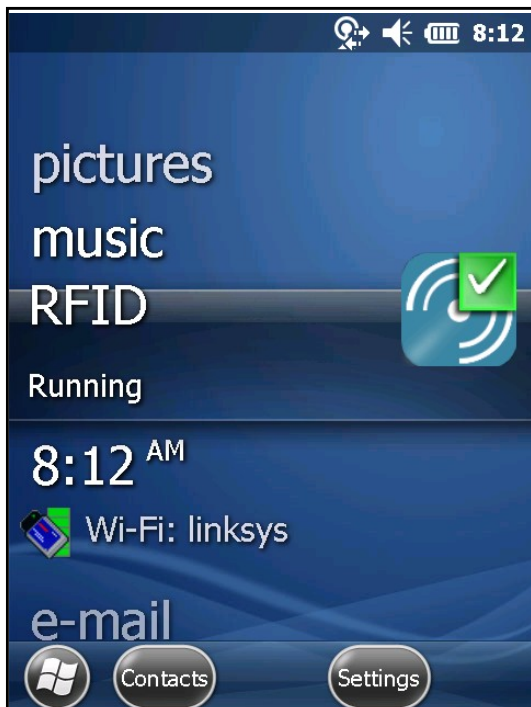

Figure 2-1 MobileRFID Icon on Main Screen

Installing a microSD Card

The microSD card slot provides secondary non-volatile storage. The slot is located under the battery pack. Refer to the documentation provided with the card for more information and follow the manufacturer's recommendations for use.



CAUTION Follow proper ESD precautions to avoid damaging the SD card. Proper ESD precautions include, but are not limited to, working on an ESD mat and ensuring that the operator is properly grounded.



NOTE For SIM Card installation, refer to the mobile computer user guide for instruction.

To install the microSD card:

1. Lift rubber access door.
2. Slide the SIM card holder door up to unlock.
3. Lift SIM card holder door.

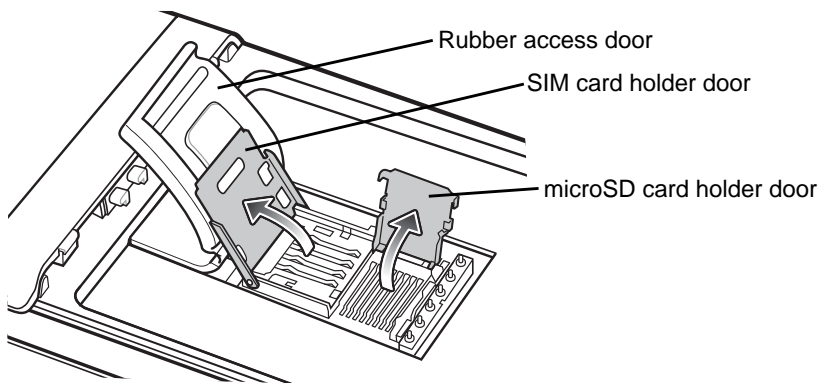

Figure 2-2 Lift SIM Slot Holder Door

4. Lift microSD card holder door.
5. Insert the microSD card into card holder door ensuring that the card slides into the holding tabs on each side of the door.

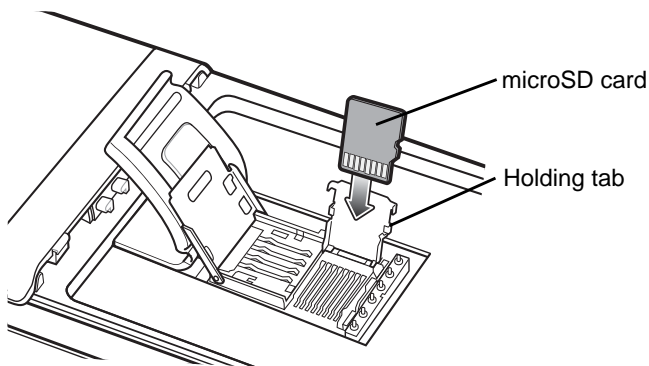

Figure 2-3 Insert microSD Card in Holder

6. Close the card holder door and push down until it is securely into place.
7. Close SIM card holder door and slide down until it locks into place.
8. Close rubber access door.

Enabling RFID on the Mobile Computer



To enable RFID on the mobile computer:

1. Download the MCRFIDInstall cab file from the support central website at: <http://www.zebra.com/support>
2. Copy the file into one of the following folders:
 - \Temp folder of the target mobile computer
 - \SD card of the target mobile computer.
3. On the display of the mobile computer, navigate to the folder previously selected and launch the *cab file*.
4. Upon completion of install, the mobile computer reboots.
5. When the device comes back online:
 - If the RFID icon on the home screen is *Green*, the mobile computer is connected to the radio module of the sled.
 - If the RFID icon on the home screen is *Blinking*, the mobile computer is trying to connect to radio module of the sled.
 - If the RFID icon on the home screen has a *Red X*, this implies the mobile computer is unable to connect to the radio module. Connect the sled and restart the RFID connection process as shown in [Figure 2-27 on page 2-20](#).

MobileRFID Icons

The MobileRFID icon indicates RFID radio status as follows:

Table 2-1 *MobileRFID Icon Indicators*

Icon	Indication
	RFID running, radio on.
	RFID running, radio off.
	RFID stopped (radio not found/battery critical/stopped from user interface).

MobileRFID Settings Menu

If using RFID as the Windows default home screen, tap the *RFID* icon, then tap the **Settings** button to view the RFID setting menu.

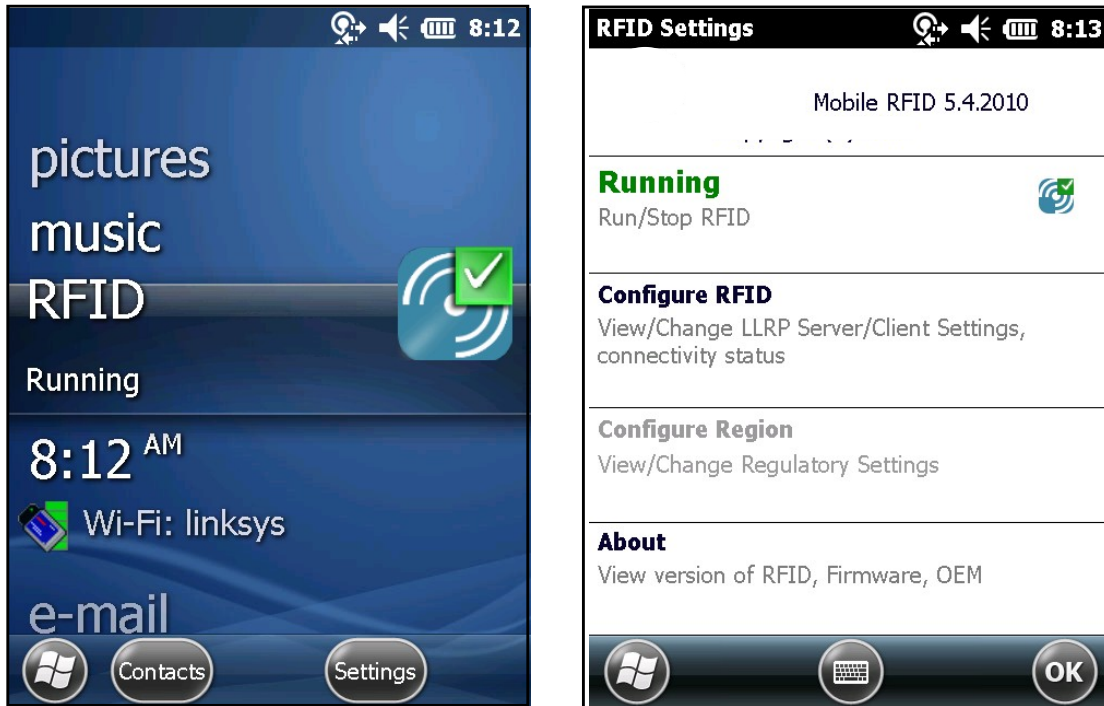

Figure 2-4 MobileRFID Home and Settings Screens

Combined Firmware Loader

The RFD5500 unit has two separate processors. A processor for control and a processor for the radio. Both processors support field upgradable firmware. This application is provided to allow either or both firmware to be updated in the field. The application loads a Combined Firmware File ([example].CFF) which determines and performs the necessary steps to load the contents of the file to the unit.

The application will perform a sequence of steps to update a unit depending on the contents of the Combined Firmware File which may include:

- Loading a new control firmware
- Updating the radio configuration
- Loading a new radio firmware.

Each stage is indicated on the user interface and the progress for that stage displays.

Combined Firmware Application

Along with the cab file for the application, a *Combined Firmware File* (.CFF) is provided which contains the update for RFD5500 unit. Copy the file to a folder (your *My Documents* folder is suggested for easy access). Select the *default* location to install. Once installation is complete, a confirmation message displays to let you know that the Combined Firmware Loader successfully installed.



Figure 2-5 Combined Firmware Installation Screen

Combined Firmware Preparation

To ensure a successful update, the RFD5500 and associated mobile device should be on charge for the duration of the update. The application tests to see if the mobile computer is charging when an update is started. If the mobile Computer is not on charge, the application will check the battery level of the mobile computer and the RFD5500 unit. If either battery is below half charge, the application will display an appropriate error and will not commence the update. A USB ActiveSync connection should be disconnected if present.

Before the application performs an update to the RFD5500, it checks that the file provided is compatible with the current hardware and not commence the update if the RFD5500 is not compatible.

If an update does not succeed, it should be sufficient to perform any corrective action required and restart the update. Refer to the [Combined Firmware Troubleshooting on page 2-9](#) section for more information.

Launch Combined Firmware Application

To start the application, tap the *Combined Firmware Loader* icon on the Start Menu.

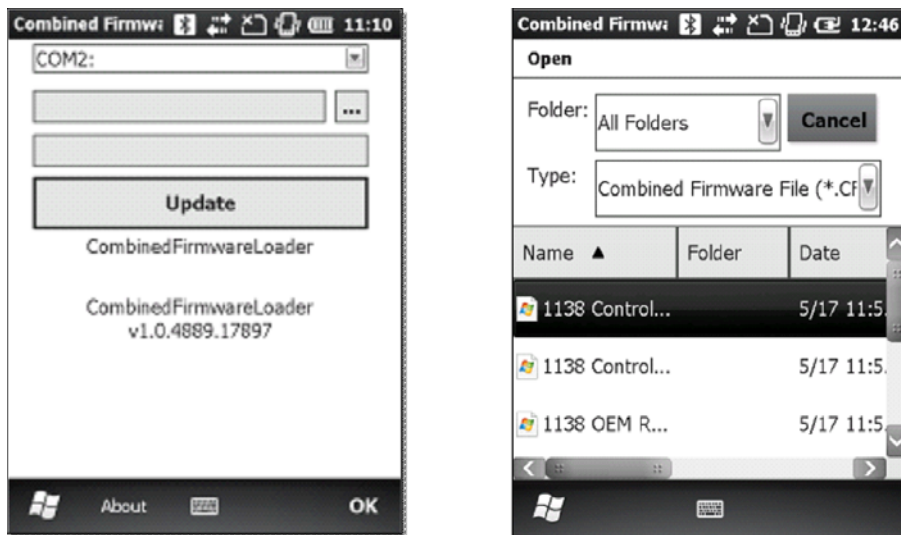

Figure 2-6 Combined Firmware Launch Screen

The accessory Com port is detected automatically and displays at the top of the screen.

Tap the (...) button (shown next to the second field in the first screen above) to select a Combined Firmware File (*.CFF") to update the accessory. Once a file is selected, the file name displays.

Performing an Update

Tap the **Update** button to begin an update. The application loads the selected file, determines the steps required to perform the update and displays the steps as they are performed. Depending on the file selected, a different number of tasks displays.

Update Control Firmware Only

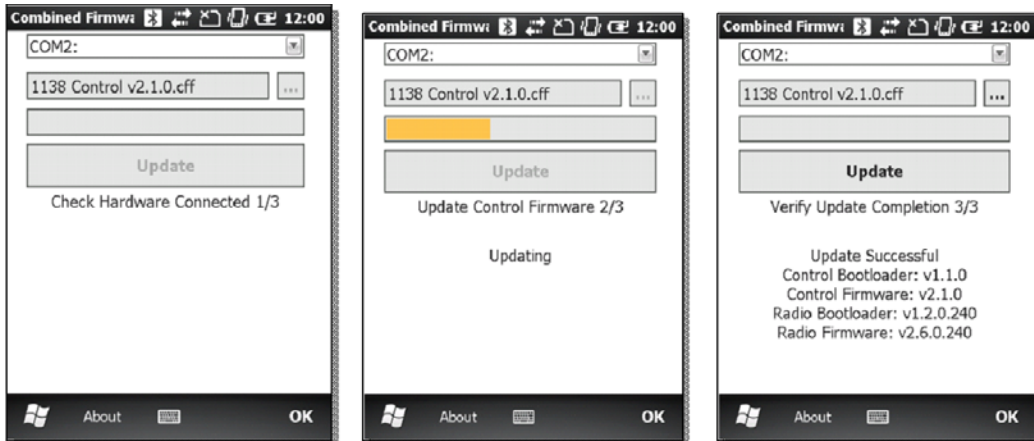

Figure 2-7 Update Control Firmware Only

Update OEM Register Only



Figure 2-8 Update OEM Register Only

Update Radio and Control Firmware

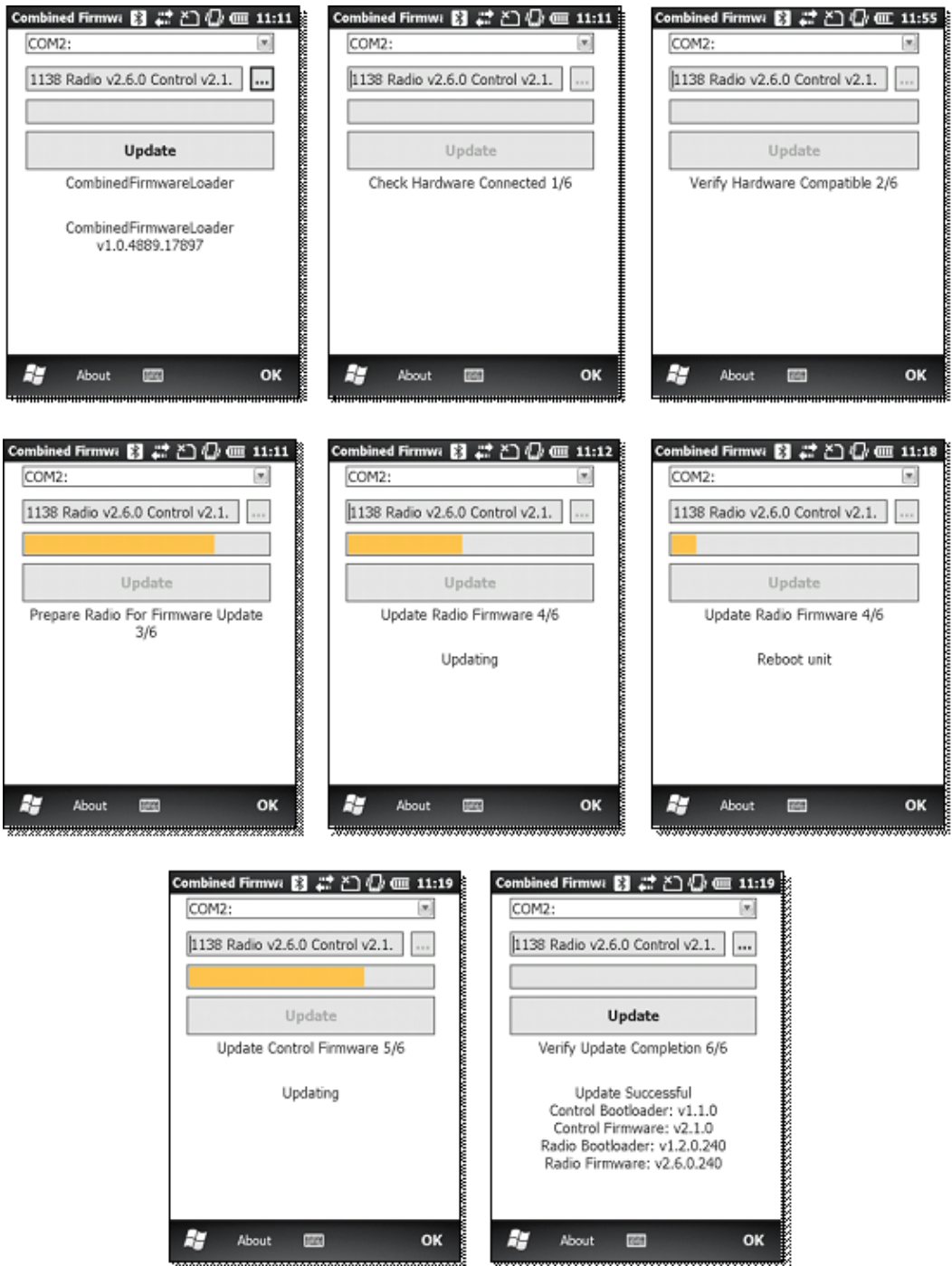

Figure 2-9 Update Radio and Control Firmware

Combined Firmware Troubleshooting

If an update fails, it may be an easily corrected error. Select **Update** to restart the application. The application detects the current state of the accessory and performs the required steps to complete the update.

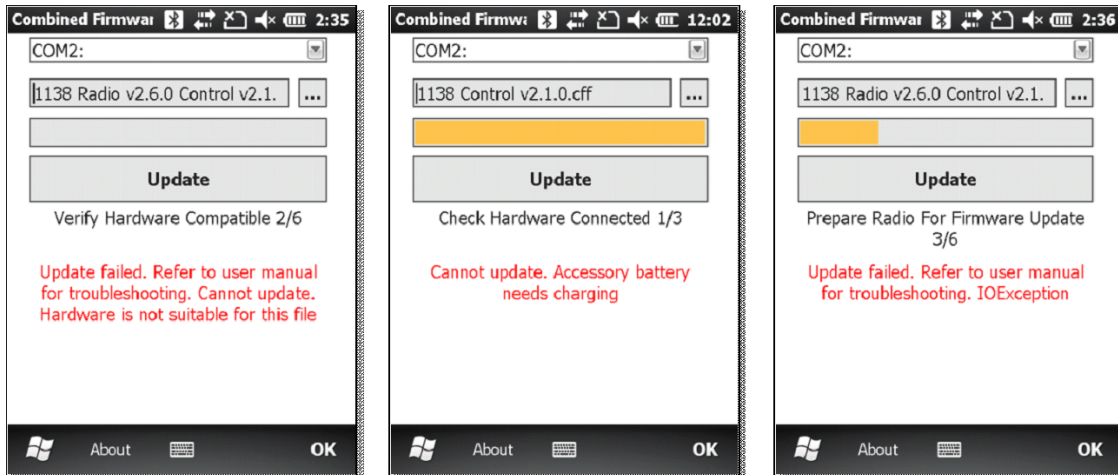

Figure 2-10 Update Failed Message

- *Invalid firmware file/hardware not compatible* - If the application reports that the Combined Firmware File is invalid or not compatible with the accessory, contact the supplier of the file to obtain the correct file for the hardware.
- *Low battery* -The application requires the mobile computer and accessory to be on charge to perform the update. If not on charge, the battery of both the accessory and the mobile device must have sufficient charge to complete the update. Either put the mobile computer and accessory on charge and update while charging or charge both units before attempting to update again.
- *Communication error* - If the update fails while updating the radio firmware, the accessory may lock in the radio bootloader. If this occurs, the accessory should be detached from the mobile computer and the accessory battery removed. After five seconds, replace the battery and the accessory attached to the mobile computer and restart the update.

ETSI Channel Selector

The ETSI Channel Selector allows a user to enable or disable the channels in use on a RFD5500 when configured for the ETSI regulatory region.

The application is provided as a cab file. Copy the cab file to the mobile computer that will be used with the RFD5500. Browse to the cab file using file explorer on the mobile computer and tap on the cab file to install the application. Accept the *default* location and tap **Install** to complete the installation. The application *ETSI Channel Select* will then appear as an application on the Start Menu.

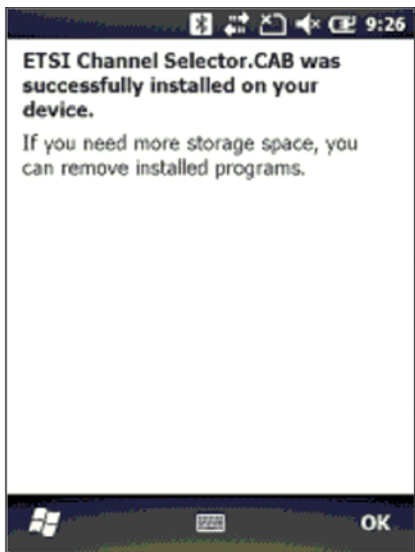

Figure 2-11 ETSI Channel Selector Installation Screens

ETSI Channel Selector Application

Tap the *Channel Selector* icon located on the Start Menu screen.

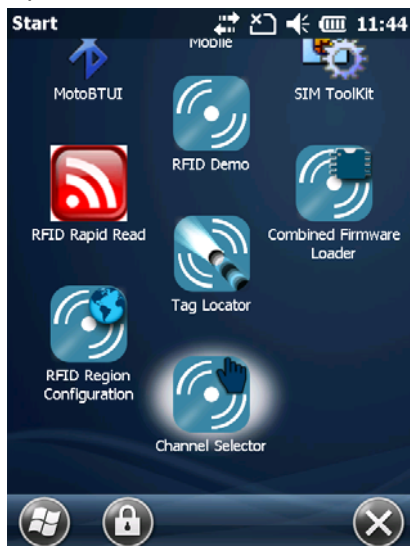

Figure 2-12 Channel Selector Icon

To start the application, tap the *ETSI Channel Select* icon on the main screen from the *Start* Menu. Select the check box(s) to enable required channels.

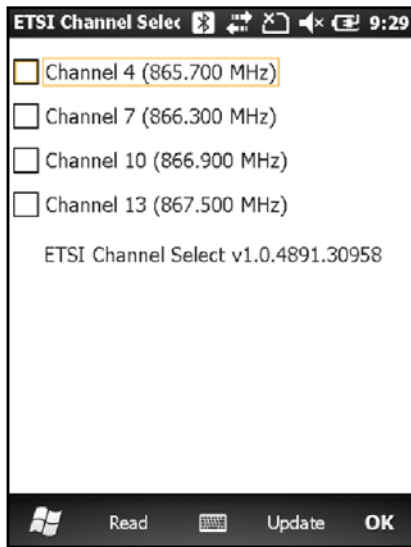

Figure 2-13 *ETSI Channel Selector Main Screen*

Channel selection options are as follows:

- *Read* - Reads the current selection from the UHF Reader and updates the screen
- *Write* - Writes the current selection to the UHF Reader
- *OK* - Exits the application.

Read Channel Selection

To read the current selection, tap the **Read** button. The application will connect to the Reader, read the configuration and disconnect.

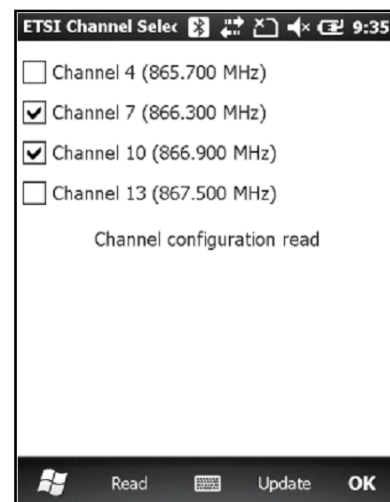
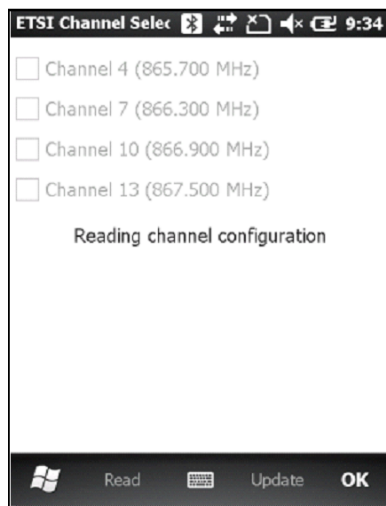

Figure 2-14 *Reading Channel Selection Screens*

Write Channel Selection

Select required channels and tap the **Write** button to write the current selection. The application connects to the reader, writes the configuration and disconnects.

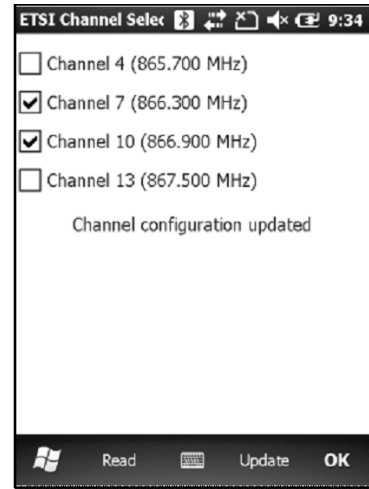
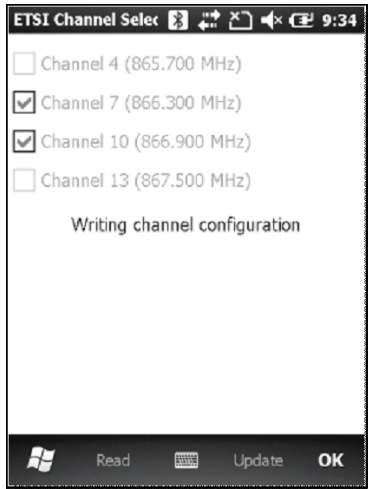

Figure 2-15 Writing Channel Selection Screens

ETSI Channel Selector Troubleshooting

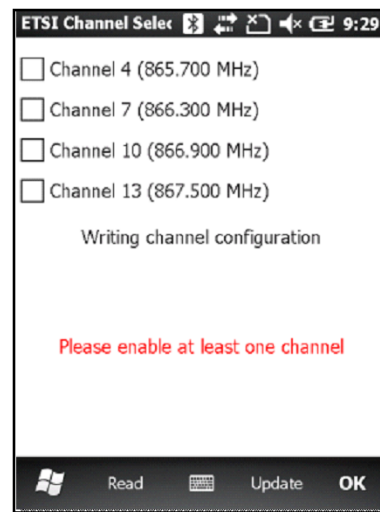
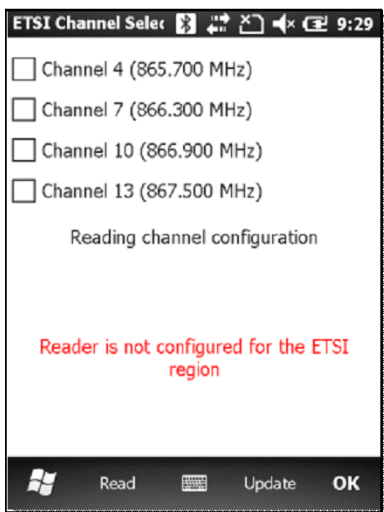

Figure 2-16 Channel Selector Failure Messages

- If a read or write does not succeed an error message displays.
- The application will only work with the 1138-01 ETSI units.
- When writing, at least one channel must be enabled.
- If you have trouble connecting to the UHF Reader:
 - Check connection
 - Confirm that the battery is installed
 - Check that the battery is charged.

RFID Region Configuration

Region Configuration Operation

Tap on the *RFID Region Configuration* icon on the *Start* Menu.

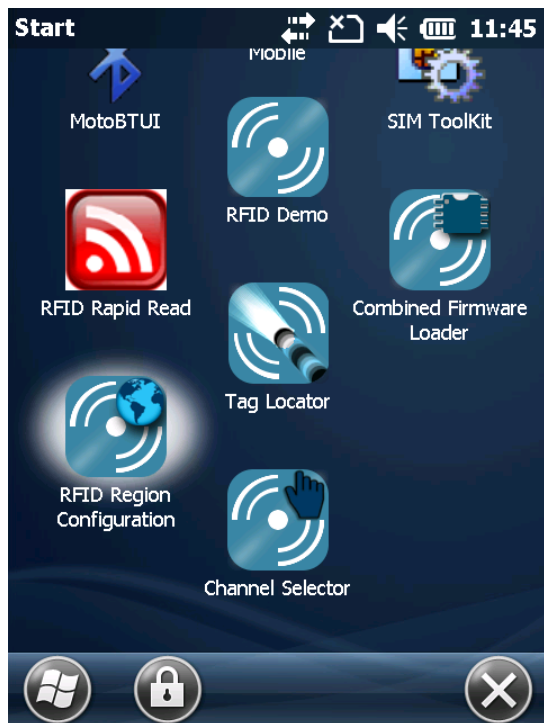

Figure 2-17 *RFID Region Configuration* Icon

The configuration application loads and a regulatory screen appears. Tap **OK** to accept the warning and continue. **Cancel** will exit the application.

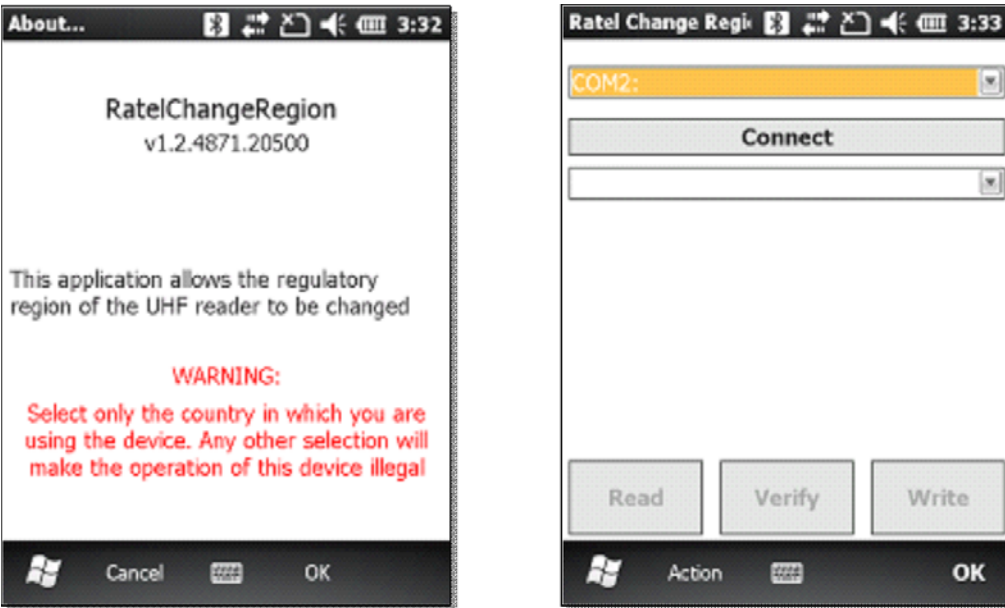

Figure 2-18 RFID Region Configuration Start Screen

Use the drop-down list to select the serial port (COM), virtual or real, that the Reader connects to. Tap on the **Connect** button.

After a short delay, the configuration application connects to the Reader. The **Connect** button appears grey and the list of available regulatory regions for the RFID Reader is displayed in the drop-down list.



Figure 2-19 Serial Port and Region Configuration Screen

Configuring Region by Country

Before writing a new region, make sure that the Reader and mobile computer batteries are fully charged. Select the country that is required (the region which applies is shown in brackets).



Figure 2-20 Change Region Screen

The list is filtered to only show the countries and regions that are compatible with the Reader that is currently connected. The contents of the list may vary from those shown above.

Select the required region and then tap the **Write** button to start the process of configuring the Reader to the new region. The message *Updating Region* displays.

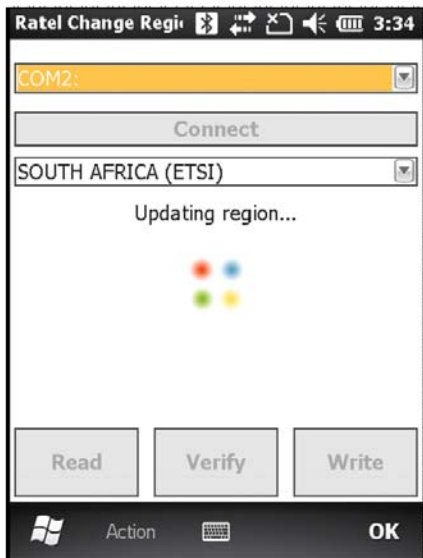

Figure 2-21 Updating Region Screen

When the update is complete, a confirmation message appears stating the region programmed. Tap the **OK** button to exit the application.



Figure 2-22 *Change Region Confirmation Screen*

The current country selection and regulatory region for a Reader can be viewed by tapping the **Read** button. When the read is complete, a message appears with the region that the Reader is set to and the date selected.



Figure 2-23 *View Region and Country Selection Screen*

To Verify the programmed Reader region against the region file, select the required region from the drop-down list and tap **Verify**. When the verify is complete, a message appears stating *Region is programmed correctly* or *Programmed region does not match values from file*.



Figure 2-24 Verify Region Screen

MobileRFID Client Mode

RFID is in Server Mode by default. To configure RFID to operate in Client Mode:

1. Invoke the MobileRFID menu and then tap **Configure RFID**.

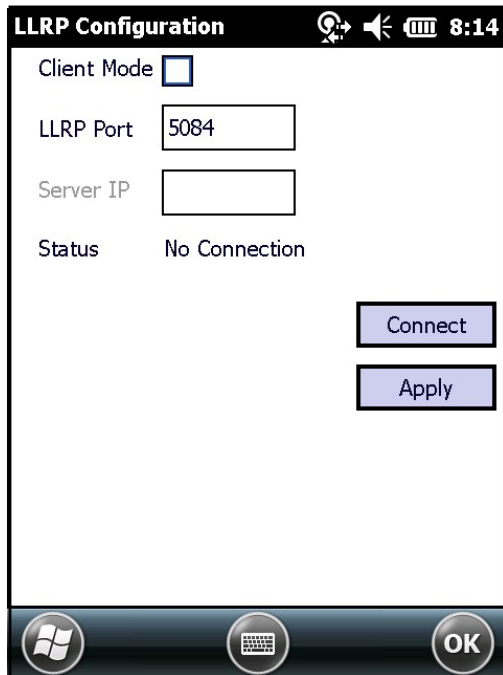

Figure 2-25 MobileRFID Configuration Screen

2. Select the *Client Mode* check box.
3. In the *LLRP Port* field, enter the port number on which the server waits for the RFID client to communicate. The default is *5084*.
4. In the *Server IP* field, enter the server IP for the remote host to which RFID communicates as a client.
5. Tap **Apply**.
6. Tap **OK** to close the window.

MobileRFID Version Information

To view software version information for the RFID application, invoke the MobileRFID menu and tap **About**.

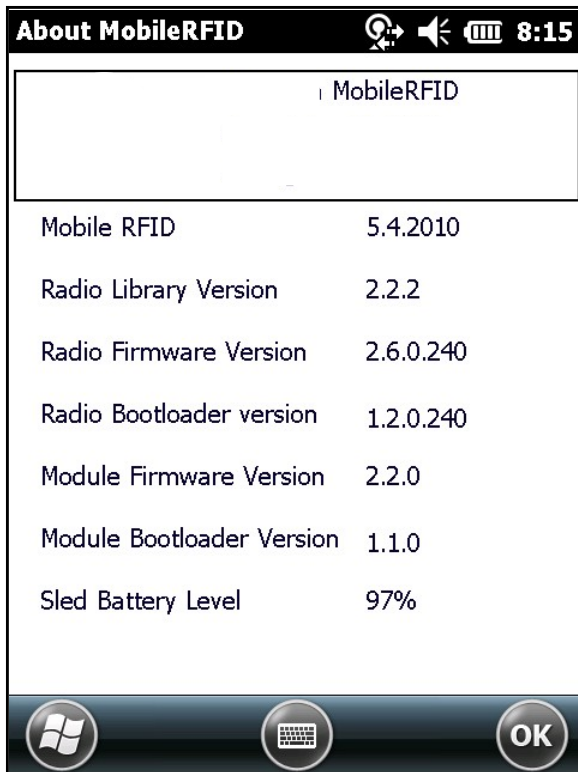

Figure 2-26 *About MobileRFID Screen*

✓ **NOTE** The version information in [Figure 2-26](#) may differ from the information on the actual mobile computer screen.

MobileRFID Run/Stop RFID

To stop RFID service, tap **Stop** in MobileRFID menu. To restart RFID, tap **Run** in MobileRFID menu.

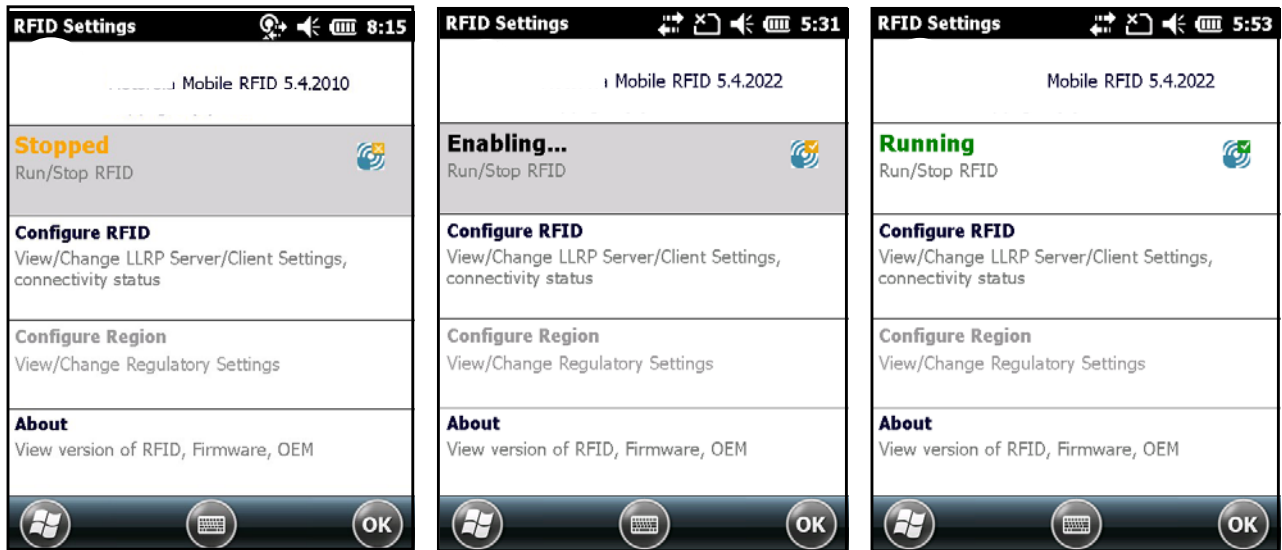

Figure 2-27 RFID Run/Stop Screen

Chapter 3 RFID Sample Application

Introduction

The RFID Application CS_RFID3Sample6.exe provides an overview of how the application works and assists application developers in developing custom applications.

The Mobile Computer can read, write, lock, kill, and program Gen2 tags. Each tag contains the EPC number (64 or 96 bits), CRC, and kill code. The Mobile Computer can also collect data by decoding in-range EPC Gen2 RFID tags.

Initiating the read command within the sample application causes the Mobile Computer to interrogate all RFID tags within the radio frequency (RF) field of view. The reader captures data from each new tag and adds it to the list box in the **EPC ID** window. Select **Stop Read** to stop interrogating tags.

✓ **NOTE** Images and screens pictured in this guide are samples and may differ from actual screens.

RFID Sample Application

To use the RFID sample application:

1. Tap the *RFID Demo* icon on the *Start* Menu to start the RFID sample application.



Figure 3-1 *RFID Demo* Icon

- In the sample application window, tap the **Start Reading** button to initiate the tag read. Tap **Stop Reading** to terminate tag reading.

✓ **NOTE** The RFD5500 does not support the *Mem Bank* drop-down used to select a tag memory bank to read.

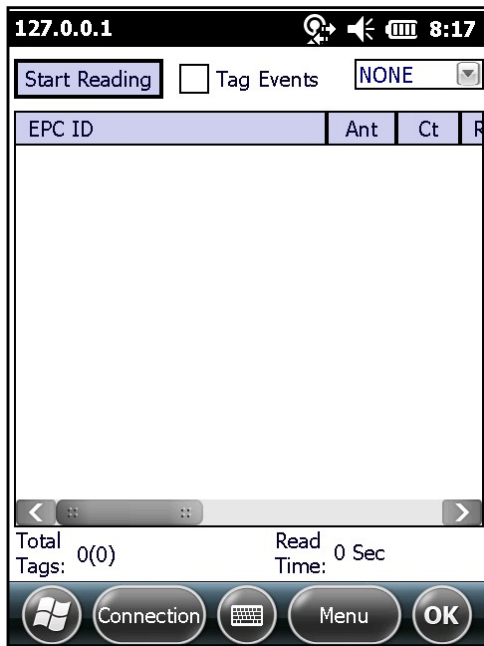

Figure 3-2 RFID Sample Application Screen

- Tap **Connection** to display the Reader IP and port number. Select **Disconnect** to disconnect the Reader.

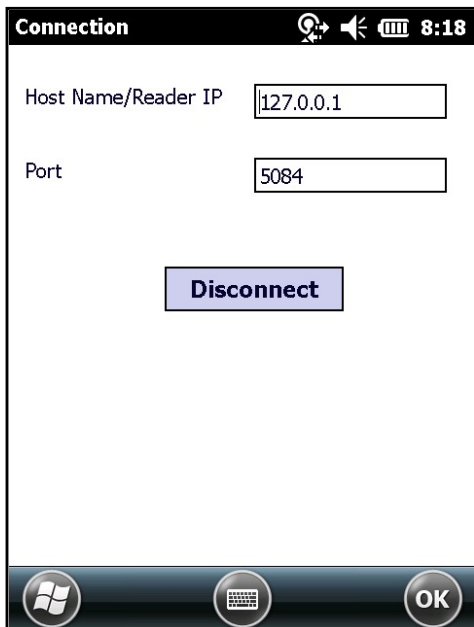
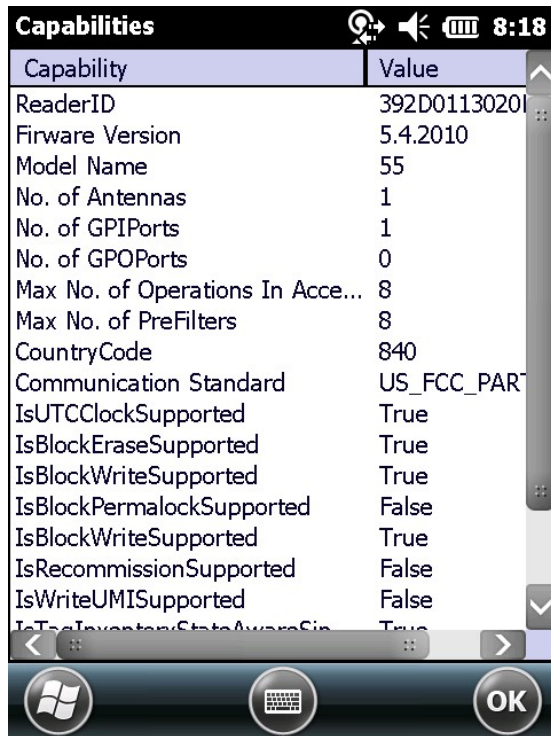

Figure 3-3 Connection Screen

Capabilities

Select **Menu > Capabilities** to view the capabilities of the connected Reader.



Capability	Value
ReaderID	392D01130201
Firmware Version	5.4.2010
Model Name	55
No. of Antennas	1
No. of GPIOPorts	1
No. of GPOPorts	0
Max No. of Operations In Acce...	8
Max No. of PreFilters	8
CountryCode	840
Communication Standard	US_FCC_PART
IsUTClockSupported	True
IsBlockEraseSupported	True
IsBlockWriteSupported	True
IsBlockPermalockSupported	False
IsBlockWriteSupported	True
IsRecommissionSupported	False
IsWriteUMISupported	False
IsTagInventoryStateAwareSin	True

Figure 3-4 Capabilities Screen

Configuration Menu Options

The Configuration menu includes the following options:

- Tag storage settings
- Antenna
- RF mode
- Singulation
- Reset to factory defaults.

Tag Storage Settings

Select **Menu > Config > Tag Storage Settings** to view/configure tag storage settings.

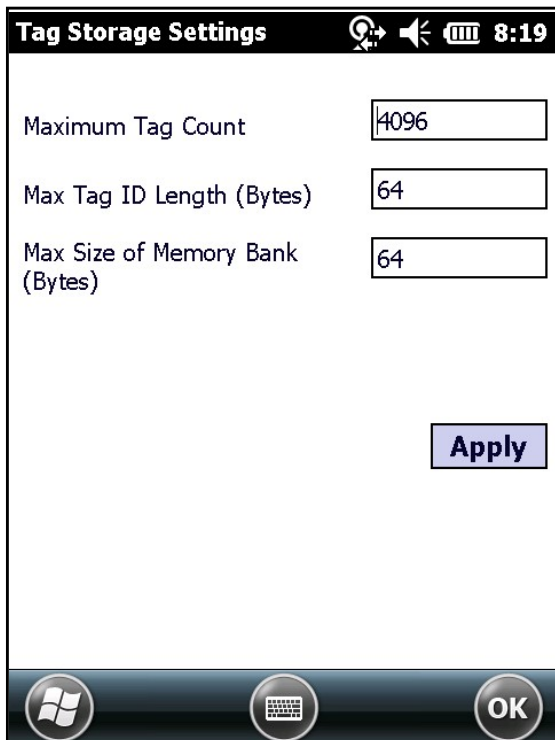

The screenshot shows a mobile application interface for configuring tag storage settings. The title bar at the top reads "Tag Storage Settings" and includes system icons for signal strength, volume, and battery, along with the time "8:19". The main area contains three text input fields, each with a label and a value:

Field Label	Value
Maximum Tag Count	4096
Max Tag ID Length (Bytes)	64
Max Size of Memory Bank (Bytes)	64

Below the input fields is a blue "Apply" button. At the bottom of the screen is a navigation bar with three circular icons: the Windows logo, a keyboard icon, and an "OK" button.

Figure 3-5 Tag Storage Settings Screen

- To configure tag storage settings, enter information in following fields:
 - *Maximum Tag Count* - The maximum number of tags to store in the DLL.
 - *Max Tag ID Length* - The maximum tag length.
 - *Max Size of Memory Bank* - Storage to allocate for the memory bank data.
- Select **Apply** to apply the configuration changes.

Antenna

Select **Menu > Config > Antenna** to view/configure the antenna.

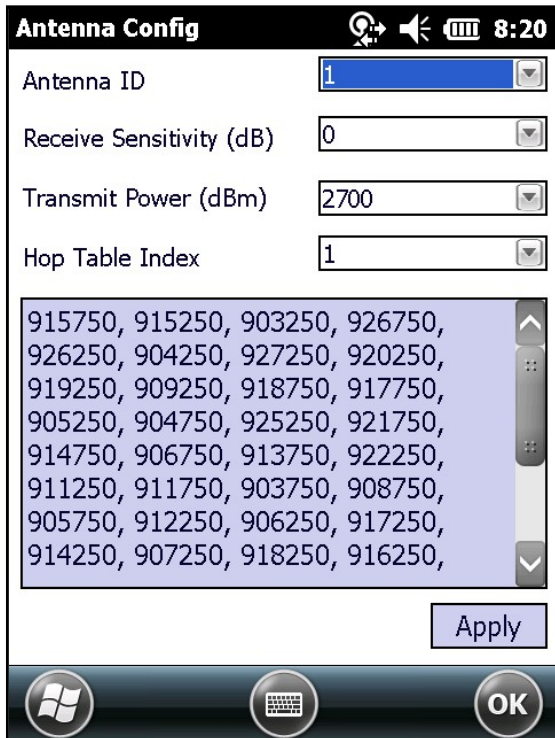

Figure 3-6 Antenna Configuration Screen

- To configure the antenna settings, enter information in the following fields:
 - *Antenna ID* - Selecting an antenna ID updates the configuration values in the other fields.
 - *Receive Sensitivity (dB)* - Lists the Reader-supported values for the selected antenna.
 - *Transmit Power (dBm)* - Lists the Reader-supported values for the selected antenna.
 - *Hop Table Index* - Updates the Hop Frequency list with its corresponding frequencies.
- Select **Apply** to apply the configuration changes.

RF Mode

Select **Menu > Config > RF Mode** to view/configure the RF mode for each antenna.

Parameter	Value
Mode Identifier	4
DR	DR_64_3
Bdr	62500
M	MV_4
Forward Link Modulation	FORWARD_LIN...
PIE	1500
Min Tari	25000
Max Tari	25000
Step tari	0
Spectral Mask Indicator	SMI_DI

Figure 3-7 RF Mode Screen

- To configure RF mode, enter information in the following fields:
 - *Antenna ID* - Selecting an antenna ID updates the configuration values in the other fields.
 - *Tari Value* - TARI specified in nsec.
 - *RF Mode Table* - RF mode table configured for the current antenna.
- **Apply** - Select to apply the configuration changes.

Singulation

Select **Menu > Config > Singulation** to view/configure the singulation control settings for each antenna.

Singulation 8:21

Antenna ID: 1

Session: S0

Tag Population: 100

Tag Transit Time: 0

State Aware

Inventory State: STATE A

SL Flag: DEASSERTED

Apply



Figure 3-8 Singulation Control Settings Screen

- To configure the singulation control settings, enter information in the following fields:
 - Antenna ID* - Selecting an antenna ID updates the configuration values in the other fields.
 - Session* - The session number for the inventory operation.
 - Tag Population* - The approximate tag population in the RF field of the antenna.
 - Tag Transit Time* - The time in milliseconds that the tag typically remains in the RF field of the antenna.
 - State Aware* - Indicates if the antenna performs state aware or state unaware singulation.
 - Inventory State* - Select a tag of state A or B. Valid only for State Aware singulation.
 - SL Flag* - Valid only for State Aware singulation.
- Select **Apply** to apply the configuration changes.

Reset to Factory Default

To restore the default reader configuration, **Menu > Config > Reset to Factory Default**.

Operations Menu Options

The **Operations** menu includes the following options:

- Antenna Info
- Filter
- Access
- Triggers.

Antenna Info

Select **Menu > Operations > Antenna Info** to view/configure the list of antennas that can be used for inventory/access operations. Select appropriate check boxes and tap **Apply** to apply changes.

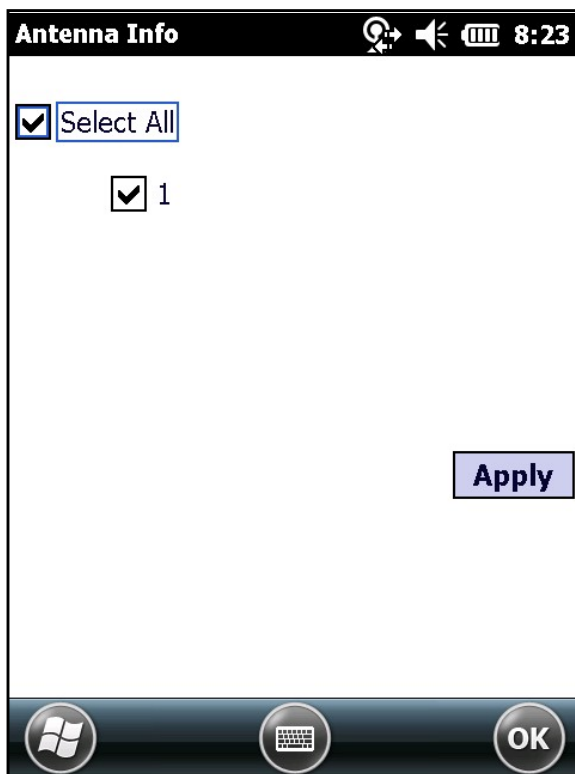

Figure 3-9 *Antenna Info Screen*

Filter

Select **Menu > Operations > Filter** to view/configure the following filters:

- Pre-Filter
- Post-Filter
- Access-Filter.

Pre-Filter

Select **Menu > Operations > Filter > Pre-Filter** to view/configure pre-filters.

The screenshot shows the 'PreFilter' configuration screen. At the top, the title 'PreFilter' and the time '8:25' are displayed. Below the title, there are several configuration fields: 'Antenna ID' is set to '1' with a dropdown arrow; 'Use Filter 1' is checked; 'Memory Bank' is set to 'EPC' with a dropdown arrow; 'Offset (Bits)' is set to '32' in a text box; 'Tag Pattern (Hex)' is set to 'AABBCCDD' in a text box; 'Filter Action' is set to 'STATE AWARE' with a dropdown arrow; 'Action' is set to 'INV A NOT INV B' with a dropdown arrow; and 'Target' is set to 'S0' with a dropdown arrow. Below these fields, there are two tabs: 'Filter 1' and 'Filter 2', with 'Filter 1' selected. An 'Apply' button is located at the bottom right of the configuration area. At the very bottom, there is a navigation bar with three icons: a Windows logo, a keyboard icon, and an 'OK' button.

Figure 3-10 PreFilter Screen

- To configure pre-filter, enter information in the following fields:
 - *Antenna ID* - Selecting an antenna ID updates the configuration values in the other fields.
 - *Memory Bank* - Memory bank on which the filter is applied.
 - *Offset* - The first (msb) bit location of the specified memory bank against which to compare the tag mask.
 - *Tag Pattern* - The pattern against which to compare the specified memory bank.
 - *Filter Action* - Select the required filter action. For more information, refer to the Gen2 specification available at <http://www.epcglobalinc.org/standards/>.
- Select **Apply** to apply the configuration changes.

Post-Filter

Select **Menu > Operations > Filter > Post-Filter** to view/configure post-filters.

Figure 3-11 *Post-Filter Screen*

- To configure post-filter, enter information in the following fields:
 - *Memory Bank* - Memory bank on which the filter is applied.
 - *Offset* - The first (msb) bit location of the specified memory bank against which to compare the tag mask.
 - *Tag Pattern* - The pattern against which to compare the specified memory bank.
 - *Tag Mask* - The bit mask to facilitate bit wise filtering.
 - *Match Pattern* - Select the tag pattern to match (A, B, both, or neither).
- Select **Apply** to apply the configuration changes.

Access-Filter

Select **Menu > Operations > Filter > Access-Filter** to view/configure the access-filters.

The screenshot shows the 'AccessFilter' configuration screen. At the top, there is a status bar with icons for signal strength, volume, and battery, along with the time '8:28'. The main area contains several input fields and a checkbox:

- Memory Bank:** A dropdown menu with 'EPC' selected.
- Offset (Bits):** A text input field containing '32'.
- Tag Pattern (Hex):** A text input field containing '11223344'.
- Tag Mask (Hex):** A text input field containing 'FFFFFFFF'.
- Tag Pattern A:** A tabbed interface with 'Tag Pattern A' and 'Tag Pattern B' tabs. 'Tag Pattern A' is currently selected.
- Match Pattern:** A dropdown menu with 'A' selected.
- Use Filter:** A checkbox that is checked.
- Apply:** A button to apply the settings.

At the bottom of the screen, there are three circular navigation buttons: a Windows logo, a keyboard icon, and an 'OK' button.

Figure 3-12 *AccessFilter* Screen

See *Post-Filter* on page 3-11 for field descriptions.

Access

Select **Menu > Operations > Access** to perform the following access operations.

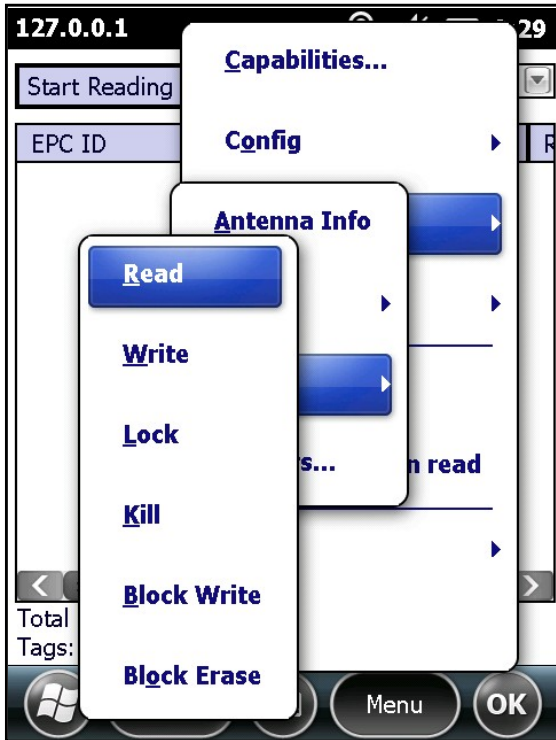

Figure 3-13 Access Menu

The Access menu includes the following options:

- Read
- Write
- Lock
- Kill
- Block Write
- Block Erase.

To perform an access option on a single tag, right-click the tag in the list of read tags on the main screen to invoke the tag's context menu.

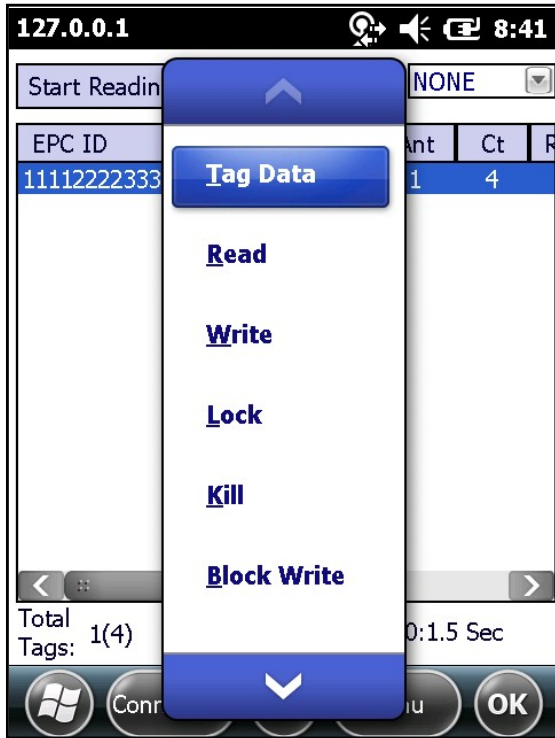

Figure 3-14 Tag Context Menu

Access Operation Windows

Set options as required in the various parameter windows. Not all windows include all options. The access operation windows include the following fields:

- *Tag ID* - The name of the selected tag.
- *Password* - Set a password before performing any access operation (except Kill).
- *Memory Bank* - Select the memory bank (Reserved, EPC, TID, User).
- *Offset* - Offset of the first word to read from the selected memory bank.
- *Length* - Tag/data length.
- *Write Data* - The data to write to the selected tag (Write window only).
- *Lock Privilege* - Access options for the selected tag (Write window only)
 - *None* - The can not change the lock privilege of the particular memory bank.
 - *Read_Write* - The user can read and write to the tag.
 - *Perma_Lock* - Permanent lock.
 - *Perma_Unlock* - Permanent unlock.
 - *Unlock* - The user can unlock the tag for writing.

Read 8:42

Tag ID (Hex) 111122223333444455556666

Password (Hex) 0

Memory Bank TID

Offset (Bytes) 0 Length (Bytes) 8

Data Read (Hex) E280110020003484

Access Filter Read

Windows Keyboard OK

Figure 3-15 Read Access Operation Screen

Write Tags 8:43

Tag ID (Hex) 111122223333444455556666

Password (Hex) 0

Memory Bank USER

Offset (Bytes) 0 Length (Bytes) 4

Data (Hex) AABBCCDD

Access Filter Write

Windows Keyboard OK

Figure 3-16 Write / Block-Write Access Operation Screen

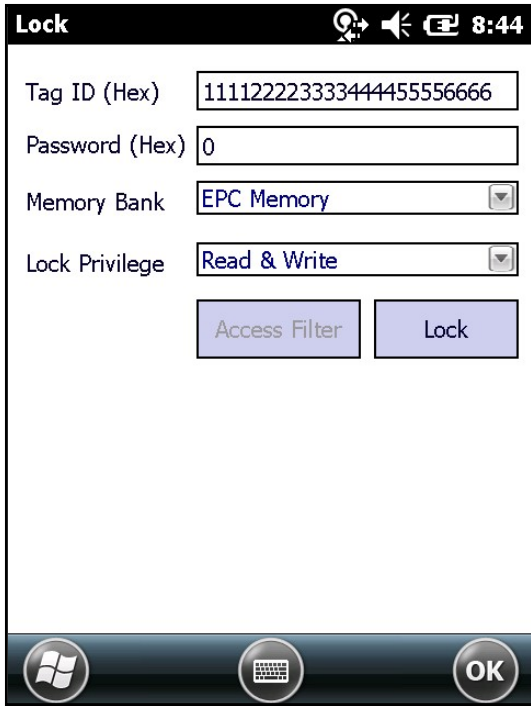

Figure 3-17 Lock Access Operation Screen



Figure 3-18 Kill Access Operation Screen

✓ **NOTE** A read length of 0 (zero) is not supported by the RFD5500.

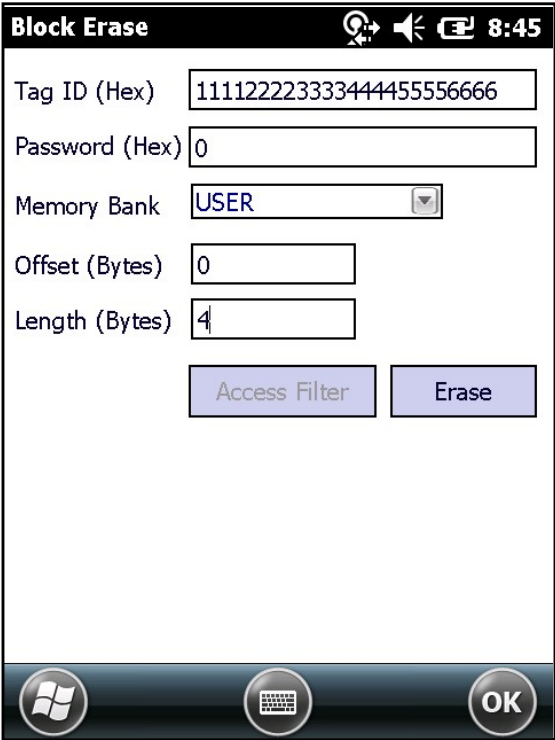

Figure 3-19 Block Erase Access Operation Screen

Triggers

Select **Menu > Operations > Trigger** to view/configure the following triggers:

- Start Trigger
- Stop Trigger
- Report Trigger.

Start Trigger

The screenshot shows a mobile application interface for configuring a trigger. The title bar reads "Trigger" and includes system icons for signal strength, volume, and battery, along with the time "8:46". The main content area contains three fields: "Trigger Type" with a dropdown menu set to "Periodic", "Start Date" with a dropdown menu set to "Feb/17/11 02:13:35 PM", and "Period(ms)" with a text input field containing "1". Below these fields is a horizontal row of four buttons: "Start Trigger", "Stop Trigger", "Report Trigger", and an empty button. At the bottom of the screen, there is a "Tag Report Trigger" field with a text input containing "1" and an "Apply" button. The bottom navigation bar features three circular icons: a Windows logo, a keyboard icon, and an "OK" button.

Figure 3-20 Start Trigger - Periodic Screen

Trigger 8:46

Trigger Type: GPI

Port: 1

Event:

High To Low

Low To High

Start Trigger | Stop Trigger | Report Trigger

Tag Report Trigger: 1

Figure 3-21 Start Trigger - GPI Screen

Trigger 8:47

Trigger Type: Handheld Trigger

Event:

Trigger Released

Trigger Pressed

Start Trigger | Stop Trigger | Report Trigger

Tag Report Trigger: 1

Figure 3-22 Start Trigger - Handheld Trigger Screen

Stop Trigger

The screenshot shows a mobile application interface titled "Trigger" with a status bar at the top displaying signal strength, volume, and the time 8:47. The main content area contains two fields: "Trigger Type" with a dropdown menu set to "Duration" and "Duration(ms)" with a text input field containing "2000". Below these fields is a horizontal menu with three tabs: "Start Trigger", "Stop Trigger" (which is selected), and "Report Trigger". Under the "Stop Trigger" tab, there is a "Tag Report Trigger" field with the value "1" and an "Apply" button. At the bottom of the screen is a navigation bar with three icons: a Windows logo, a keyboard icon, and an "OK" button.

Figure 3-23 Stop Trigger - Periodic Screen

The screenshot shows a mobile application interface titled "Trigger" with a status bar at the top displaying signal strength, volume, and the time 8:48. The main content area contains four fields: "Trigger Type" with a dropdown menu set to "GPI with Timeout", "Port" with a dropdown menu set to "1", "Timeout(ms)" with a text input field containing "2000", and "Event" with two radio button options: "High To Low" (which is selected) and "Low To High". Below these fields is a horizontal menu with three tabs: "Start Trigger", "Stop Trigger" (which is selected), and "Report Trigger". Under the "Stop Trigger" tab, there is a "Tag Report Trigger" field with the value "1" and an "Apply" button. At the bottom of the screen is a navigation bar with three icons: a Windows logo, a keyboard icon, and an "OK" button.

Figure 3-24 Stop Trigger - GPI with Timeout Screen

The screenshot shows a mobile application interface titled "Trigger". At the top, there are icons for location, volume, and battery, along with the time "8:48". The main area contains three input fields: "Trigger Type" is a dropdown menu set to "Tag Observation"; "Tag Observation" is a text box containing the number "5"; and "Timeout(ms)" is a text box containing "1000". Below these fields is a control bar with four buttons: "Start Trigger", "Stop Trigger", "Report Trigger", and an empty button. Underneath the control bar is another row with "Tag Report Trigger" (text box with "1") and an "Apply" button. At the bottom, there is a navigation bar with three circular icons: a Windows logo, a keyboard icon, and an "OK" button.

Figure 3-25 Stop Trigger - Tag Observation with Timeout Screen

The screenshot shows a mobile application interface titled "Trigger". At the top, there are icons for location, volume, and battery, along with the time "8:48". The main area contains three input fields: "Trigger Type" is a dropdown menu set to "N Attempts"; "No. of Attempts" is a text box containing the number "10"; and "Timeout(ms)" is a text box containing "1000". Below these fields is a control bar with four buttons: "Start Trigger", "Stop Trigger", "Report Trigger", and an empty button. Underneath the control bar is another row with "Tag Report Trigger" (text box with "1") and an "Apply" button. At the bottom, there is a navigation bar with three circular icons: a Windows logo, a keyboard icon, and an "OK" button.

Figure 3-26 Stop Trigger - N Attempts with Timeout Screen

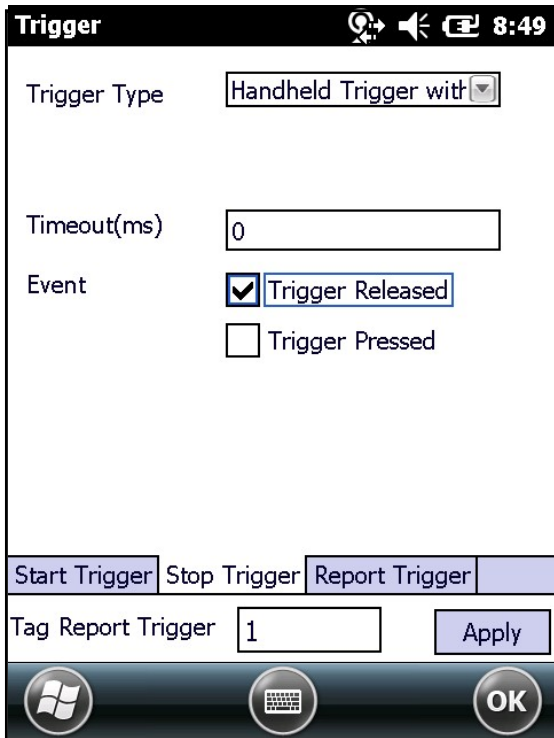

Figure 3-27 Stop Trigger - Handheld Trigger with Timeout Screen

Report Trigger

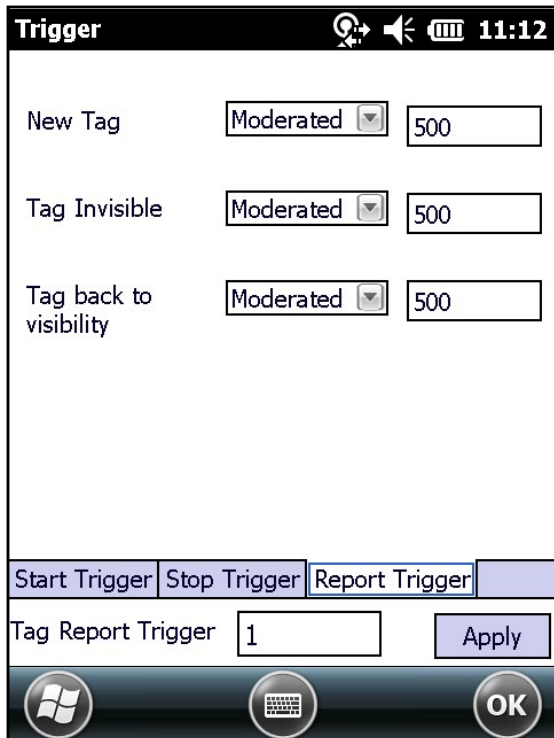

Figure 3-28 Report Trigger Screen

Management Menu Options

Management options are not applicable for handheld Readers.

Help Menu

Select **Menu > Help** to display version information. The version numbers displayed in *Figure 3-29* are examples. Actual version numbers are based on the versions of the files on the device.

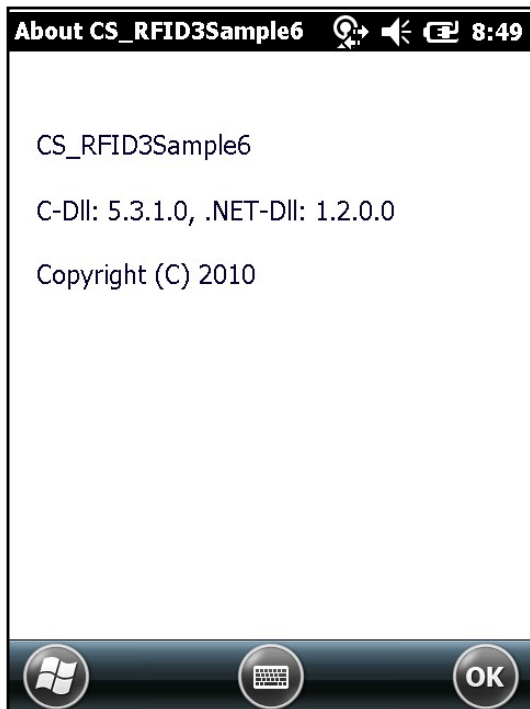

Figure 3-29 *Help Screen*

Exit

Select **Menu > Exit** to exit the RFID sample application.

Chapter 4 RapidRead Sample Application

RapidRead Introduction

RapidRead is a RFID handheld reader application used to demonstrate inventory and asset counting, tag writing and item locating.

RapidRead Options

To access RapidRead, double tap the *RapidRead* icon on the home screen of the handheld reader or select *File Explorer > Program Files > RapidRead*.



Figure 4-1 *RapidRead* Icon

To select specific options, select **Menu > Options**.

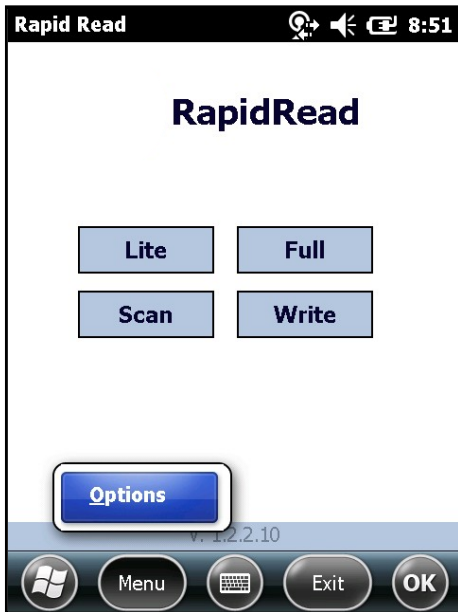

Figure 4-2 RapidRead Menu

The following selections are available on the **Options** screen:

- *Scan Sounds (applicable for Lite and Full)* - check to produce a sound for unique tag reads only, rather than on each tag read.
- *Tag (applicable for Lite only)* - check to display tag reads in SGTIN-96 format.
- *Barcode* - check to display number of unique bar codes read rather than the total number of bar codes read.
- *Unknown Tags (applicable for Full only)* - check to show tags which are not in the database but have been read.

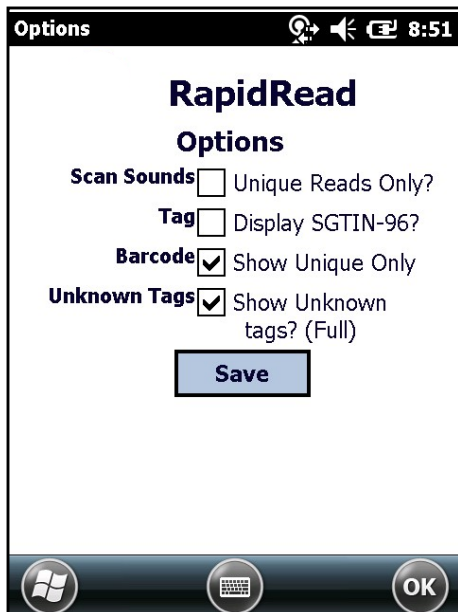

Figure 4-3 RapidRead Options Screen

RapidRead Tag File

RapidRead has the ability to read and compare against an onboard tag database (tags.csv) displaying matching results, missing and unknown items that have been read during a session.

To implement after installation is complete:

1. Locate the *tags.csv* file in the *RapidRead* application folder (under *Program* files) on the handheld reader.
2. While connected to the PC through ActiveSync or Windows Mobile Device Center, copy the *tags.csv* file from the handheld reader to desktop.

✓ **NOTE** The **tags.csv** file is a database of tagged inventory and is comma delimited without header information.

3. Using a simple text based application such as, Microsoft® Notepad, modify the file to match your specific tag EPC numbers and enter *Item Descriptions*. Separate the EPC number and item description with a comma per line for each 'valid' tag.
4. When complete, save the *tags.csv* file to your PC and copy the file back to the handheld reader, replacing the original file.

✓ **NOTE** The tag file must be renamed *tags* as it is the only database name that the handheld reader recognizes.

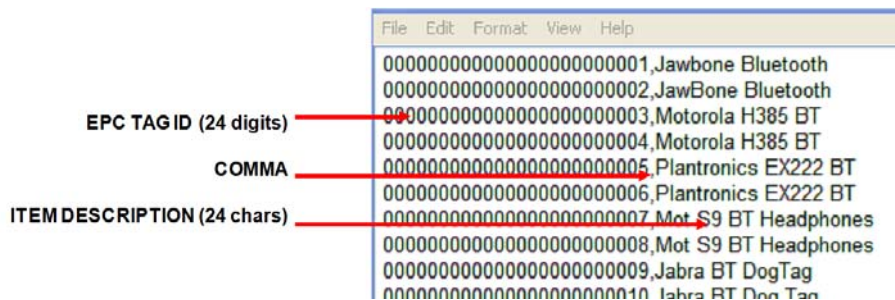

Figure 4-4 Sample List of Tags

Using RapidRead

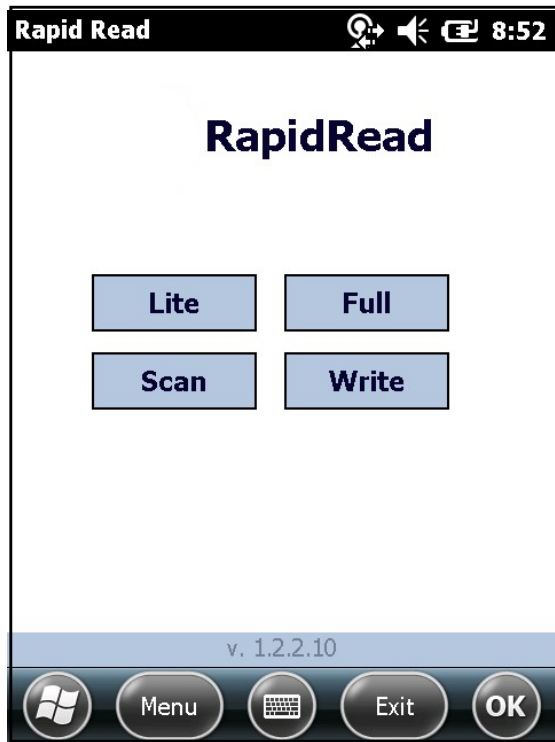

Figure 4-5 *RapidRead Main Screen*

The four modes of operation are as follows:

- **Lite** – read all tags in read range via RFID.
- **Full** – read all tags in read range via RFID; compare against database (tags.csv).
- **Scan** – bar code scanning (functions on both RFID enabled handheld as well as non-RFID handheld).
- **Write** – function to encode RFID tags by key entry, bar code scanning, or STGIN-96.

RapidRead Lite

RapidRead Lite offers the following features:

- Ability to scan all standard EPC class1 GEN2 tags within read range and display tag reads.
- Display EPC number read.
- Display number of times a particular tag has been read.
- Display unique tag count.

Summary Screen

The Summary screen displays the number of unique tags read.

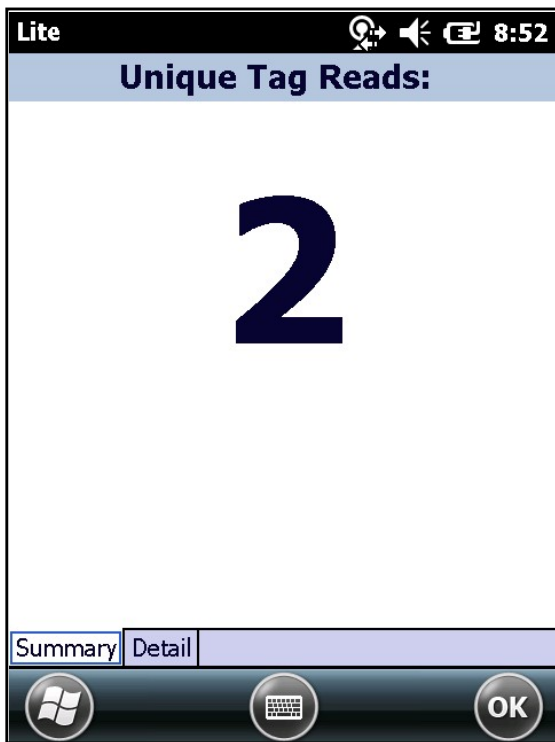

Figure 4-6 *RapidRead Lite Summary Screen*

RFID Read occurs only when the trigger is engaged.

Detail Screen

Select the *Detail* tab to display a list of individual reads. To clear the list, tap the **Clear List** button.

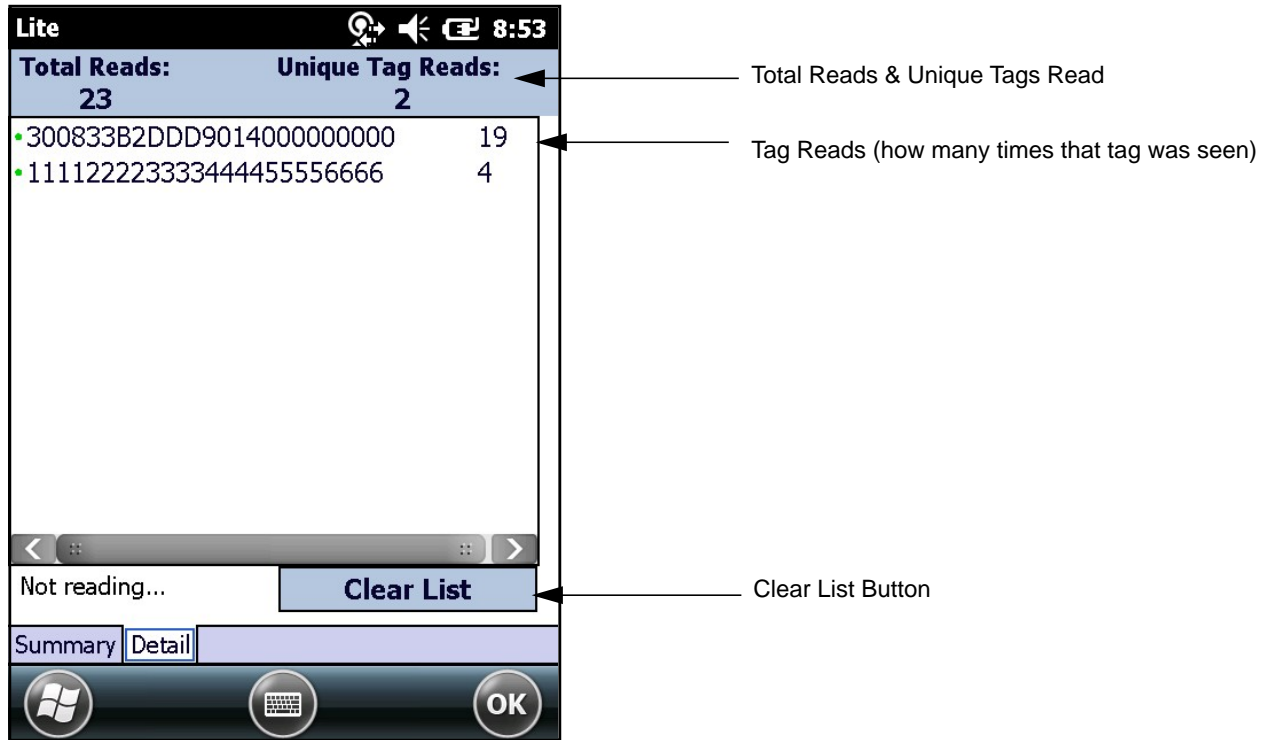

Figure 4-7 RapidRead Lite Detail Screen

- ✓ **NOTE** If SGTIN-96 format is selected, tags not in valid SGTIN-96 format appear in HEX format.
- ✓ **NOTE** If the reader display cannot accommodate the tag ID length, the application displays only a portion of the tag ID. Select the tag ID to open a window that displays the entire ID.

RapidRead Full

RapidRead Full offers the following features:

- Ability to scan all standard EPC class1 GEN2 tags within read range and display tag reads.
- Validate read against the tag database (tags.csv) in the RapidRead application folder.
- Display associated asset configurable description.
- Display number of times a particular tag has been read.
- Display total read and unique tag read counts.
- Visual and audible feedback to assist in locating a particular tag (Geiger counter).

Summary Screen

The Summary screen displays the number of unique tags read.

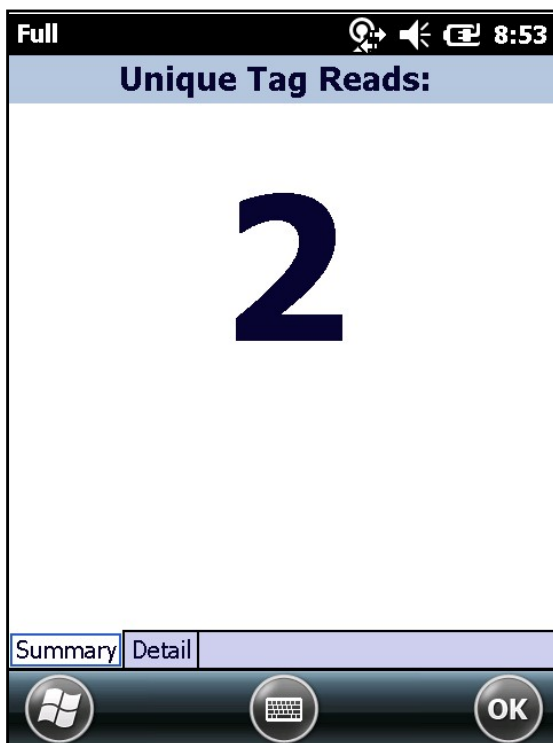

Figure 4-8 *RapidRead Full Summary Screen*

RFID Read occurs only when the trigger is engaged.

Detail Screen

The color coded indicators (located next to the titles) are defined as follows:

- Green - read is a match to an asset that has been defined in the tags.csv file.
- Yellow - expected tag but has not been read.
- Red - read does not have a match in the tags.csv file and is classified as unknown.

Select the **Detail tab** to display a list of individual reads. To clear the list, tap the **Clear Data** button.

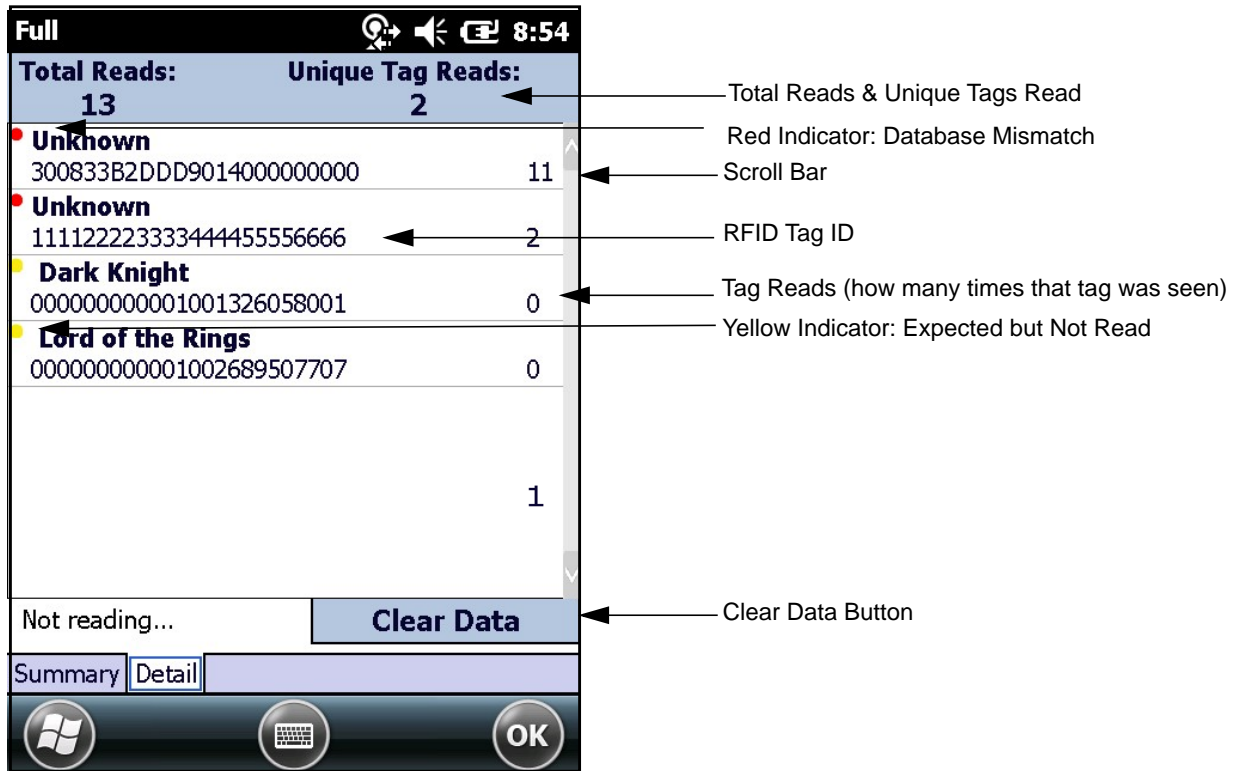

Figure 4-9 RapidRead Full Detail Screen

Geiger Counter

The Geiger counter is a tag locator application that assists with locating missing items (applicable to RapidRead Full only). To use the Geiger counter feature:

1. Select the *Detail* tab.

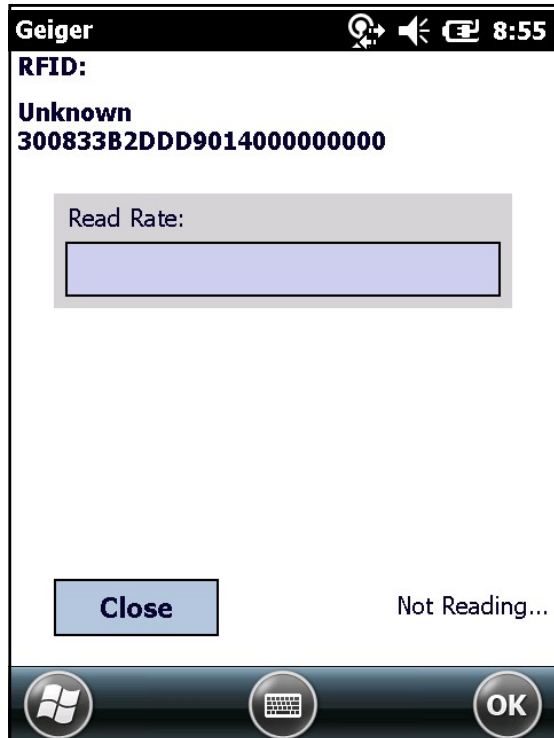

Figure 4-10 *RapidRead Full Detail Tab*

2. Tap one of the missing items. The Geiger Counter screen opens as displayed in [Figure 4-11](#).

3. Pull the handheld trigger and begin to slowly move the reader around. As the reader approaches the item, beeping frequency increases and the visual bar on the screen will become larger.

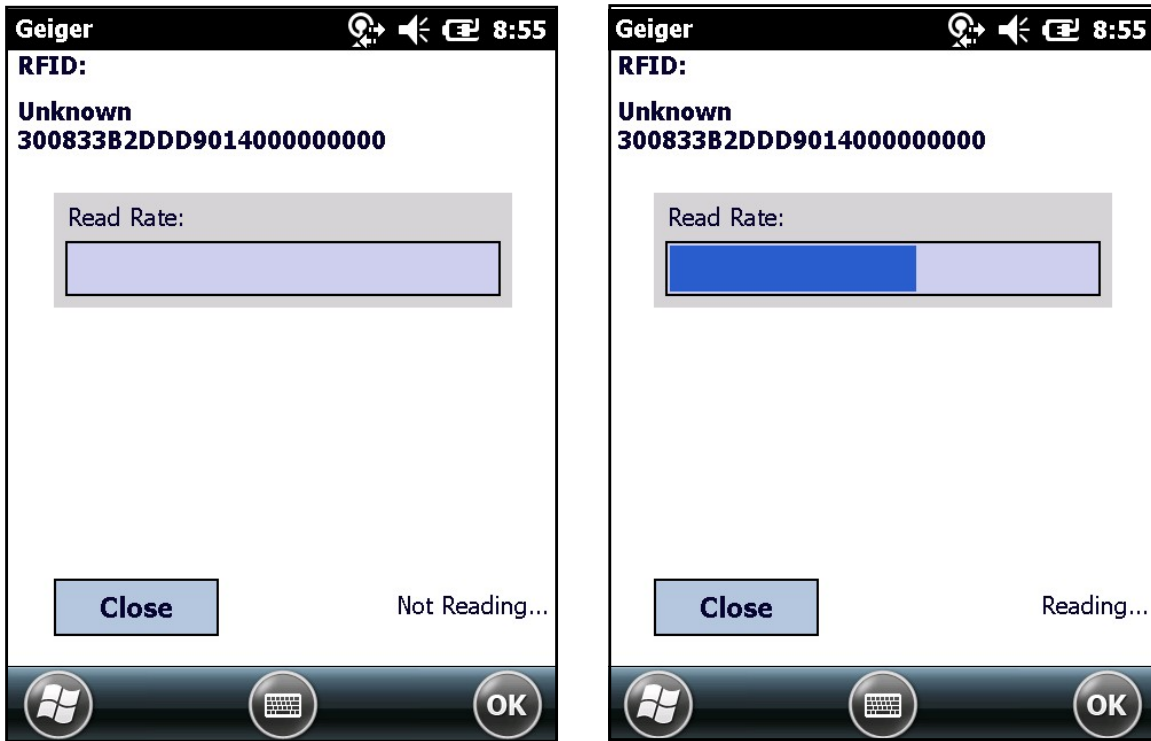

Figure 4-11 Geiger Counter Read Rate

RapidRead Scan

RapidRead Scan offers the following features:

- Ability to scan bar code.
- Display bar code read.
- Display number of times a particular bar code has been read.
- Display unique bar code count.

✓ **NOTE** RapidRead Scan mode also functions on a non-RFID handheld devices as well.

Summary Screen

Bar code read occurs only when the trigger is engaged. The Summary screen displays the number of unique bar codes read.

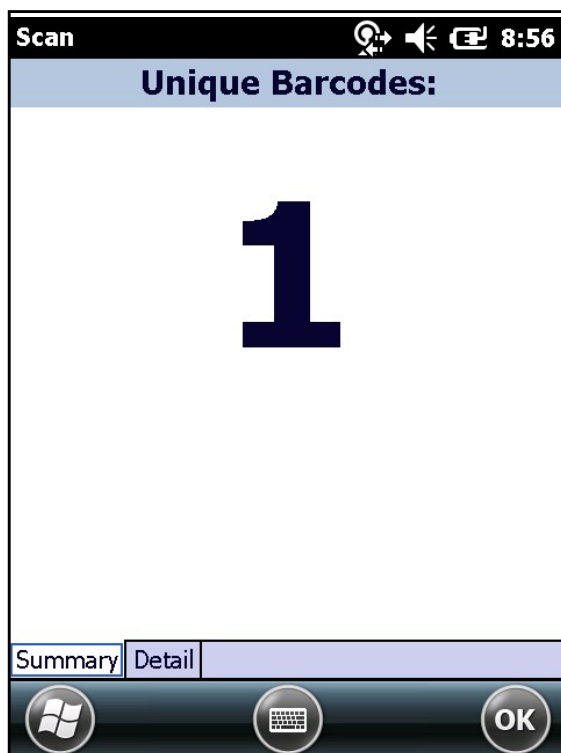

Figure 4-12 *RapidRead Scan Summary Screen*

Detail Screen

Select the *Detail* tab to display a list of individual reads. To clear the list, tap the **Clear List** button.

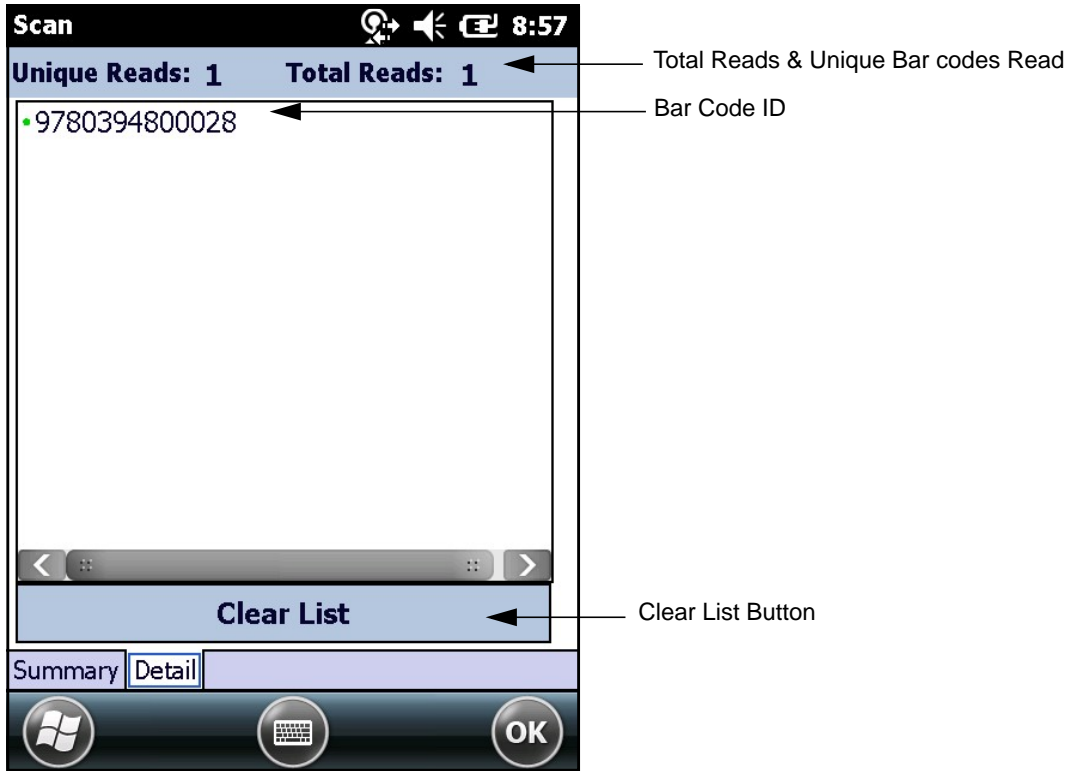

Figure 4-13 RapidRead Scan Detail Screen

RapidRead Write

The RapidRead Write methods of input are:

- Key entry
- Scan a bar code
- STGIN-96.

Key Enter Tab

To write to a tag via key entry:

1. Enter 24 digits representing the RFID tag ID.
2. Check **Auto-increment** to increment the entered number by one digit for the next tag encode.
3. Tap the **Write Tag** button to write the information to the tag. Once encoded, a successful encode message will be displayed on screen.

The screenshot shows a mobile application interface for writing to an RFID tag. The title bar at the top left says "Write" and includes system icons for signal, volume, and battery, along with the time "8:57". Below the title bar is a blue header with the text "Key Enter:". The main content area has a title "Key Enter RFID Tag ID:" followed by "(24 digits)". There is a checkbox labeled "Auto-increment" and a text input field below it. A blue button labeled "Write Tag" is centered on the screen. At the bottom, there is a tab bar with three tabs: "Key Enter" (selected), "Barcode", and "SGTIN-96". Below the tab bar is a navigation bar with three icons: a Windows logo, a keyboard icon, and an "OK" button.

Figure 4-14 RapidRead Write Key Enter Screen

Bar Code Tab

To write to a tag via bar code scan:

1. Scan a bar code to enter the bar code data in the text field. Leading zeros are added to the front of the ID if the bar code contains less than 24 digits.
2. Tap the **Write Tag** button to write the information to the tag. Once encoded, a successful encode message will be displayed on screen.

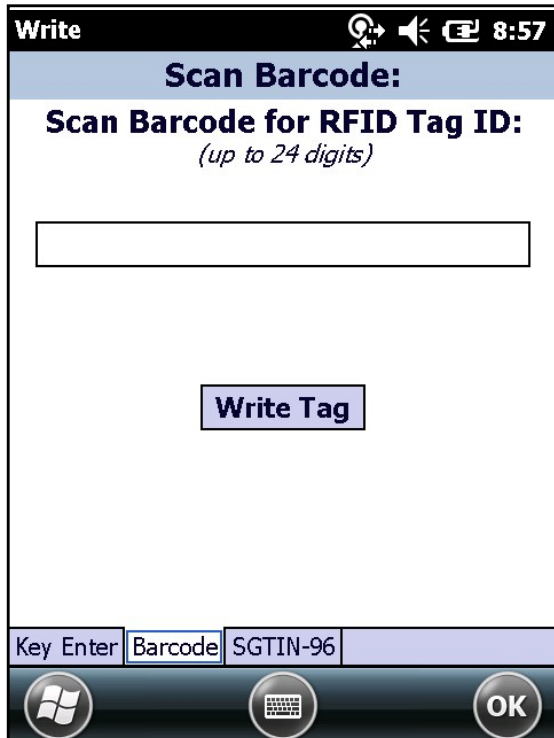

Figure 4-15 RapidRead Write Barcode Screen

SGTIN-96 Tab

Populate fields with appropriate information.

1. Enter filter data in the *Enter FILTER* field.
2. Enter partition data in the *Enter PARTITION* field.
3. Scan the corresponding UPC bar code in the *Scan UPC* field.
4. Tap the **Write Tag** button to write the information to the tag. Once encoded, a successful encode message will be displayed on screen.

The screenshot shows a mobile application interface for writing SGTIN-96 data. The top status bar includes the word "Write", signal strength, volume, and battery icons, and the time "8:58". Below this is a header bar with "SGTIN-96:". The main content area contains the text "HEADER = 48" followed by three input fields: "Enter FILTER: (001, 010, 011)", "Enter PARTITION: (0-6)", and "Scan UPC:". A "Write Tag" button is positioned in the center of the screen. At the bottom, there is a status bar with "Key Enter", "Barcode", and "SGTIN-96". The bottom navigation bar features three circular icons: a Windows logo, a keyboard icon, and an "OK" button.

Figure 4-16 RapidRead Write SGTIN-96 Screen

Chapter 5 Tag Locator

Introduction

Use Tag Locator to detect the location of a tag. By providing the Tag ID of an item, this application can find the relative position of the tag with respect to the mobile computer. Move the mobile computer back and forth to obtain the location of the tag as indicated by the beep frequency and a vertical progress bar showing the relative position of the tag.

The Tag Locator application requires the following components/DLLs on the device:

- RFIDAPI32.dll (Version 5.1.15 or higher)
- Symbol.RFID3.Device.dll (Assembly version 1.1.0.1, File version 1.1.0.7 or higher)
- Symbol.Audio.dll
- Symbol.dll
- Symbol.Notification.dll
- Symbol.StandardForms.dll.

Using Tag Locator

To use the Tag Locator application:

1. Tap *Tag Locator* icon on the mobile computer to open the Tag Locator application.



Figure 5-1 *Tag Locator*

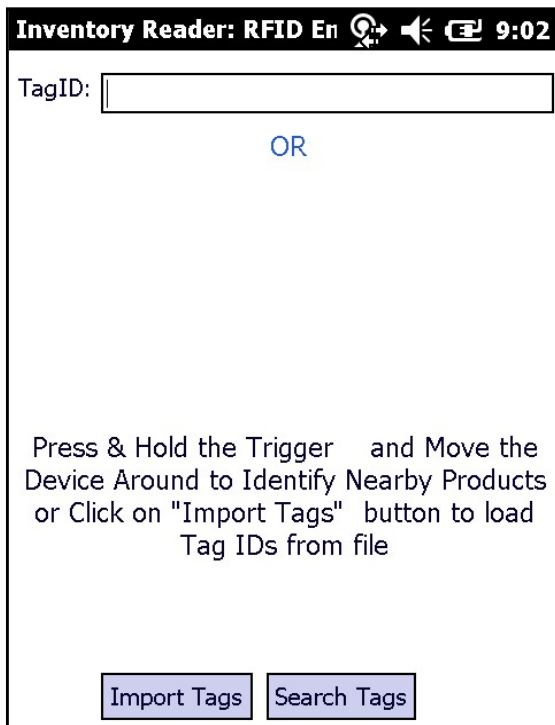

Figure 5-2 *Enter Tag ID*

Enter the tag ID in one of three ways:

- Type the tag ID in the *TagID* text box, then select **Locate** or press and hold the trigger.
- Perform a search operation by selecting the **Search Tags** button or by pressing and holding the trigger.
- Select the **Import Tags** button to import a list of saved tags from a .csv file. See [Locating Tags via .csv File on page 5-4](#).

Locating Tags via .csv File

To locate tags via a .csv file:

1. Select the **Import Tags** button to import a list of saved tags from a .csv file. The window in [Figure 5-3](#) displays.

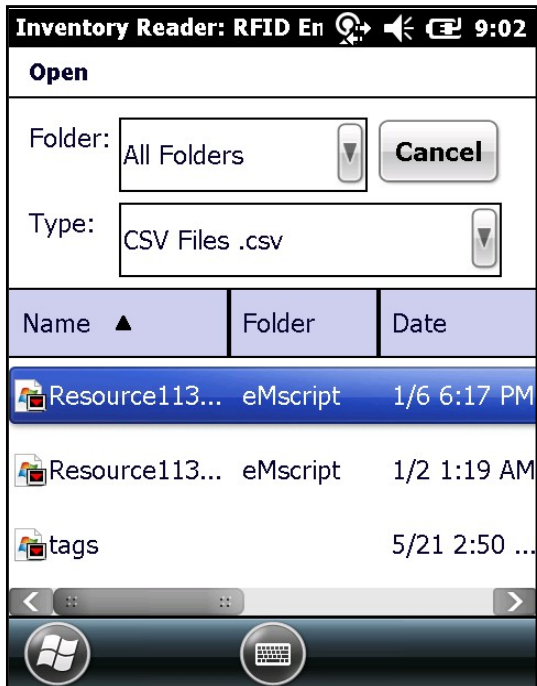

Figure 5-3 *Opening a .csv File*

2. Select the desired .csv file to import the tags to the list.

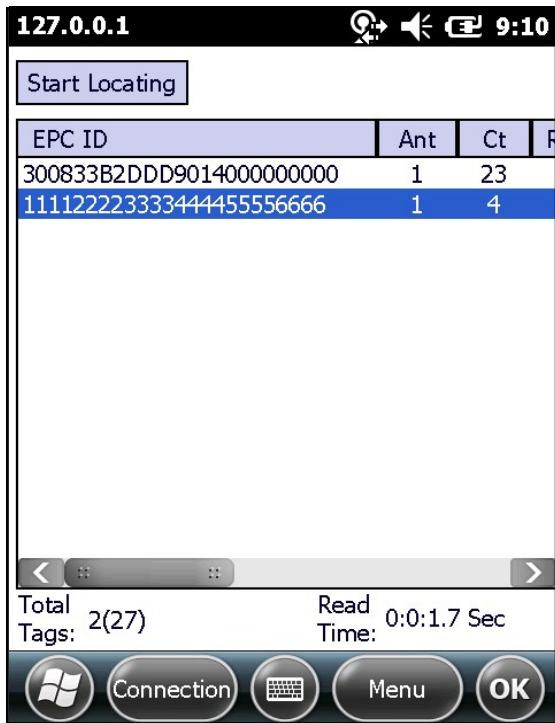

Figure 5-4 Tag List

3. Select a tag from the list to search.

4. Select the **Start Locating** button or press and hold the trigger. Move the mobile computer in all directions to get the relative position of the tag, indicated by a beep, the vertical progress bar, or both.

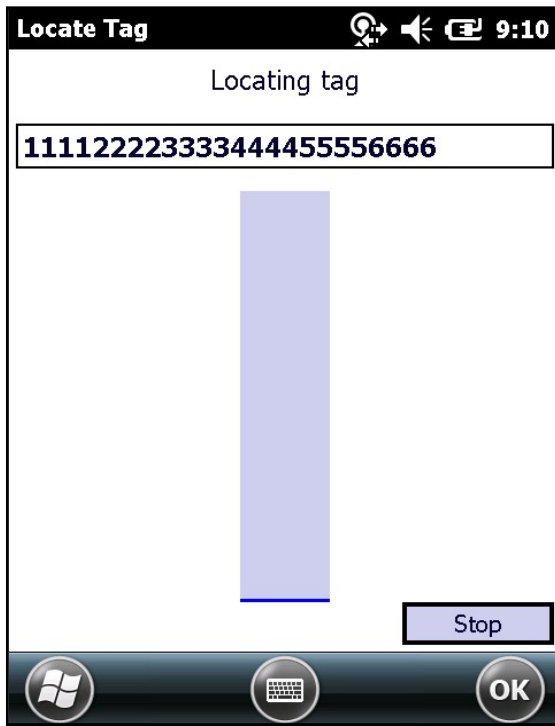

Figure 5-5 Tag Search

Select **Menu > Options** to turn the beeper on or off, and to display data in ASCII or hexadecimal format.

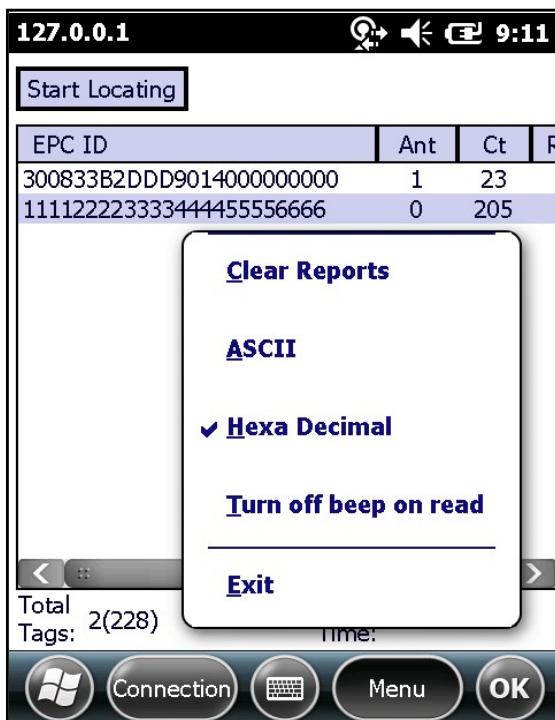

Figure 5-6 Options Menu

Chapter 6 Programming for RFD5500

Programming

The primary programming interface for the Zebra RFD5500 UHF sled reader is via the RFID3 API.

Applications for interacting with the RFD5500 sled reside on the mobile computer. Applications are developed using the RFID3 API set and use any standard assemblies included in the EMDK (as applicable). The supported programming languages are C (using Zebra EMDK for C) and .Net (using Zebra EMDK for .Net).

The recommended reference guide for the RFID3 API set is included as a part of the Zebra EMDK installer. It is available on the Zebra Support site at <http://www.zebra.com/support>. The *Programmers Guide* included in the Help section contains an introduction on how to perform various functions using the RFID3 API set.

Chapter 7 Maintenance and Troubleshooting

Introduction

This chapter includes instructions on cleaning and maintenance, and provides troubleshooting solutions for potential problems.

Cleaning



CAUTION Always wear eye protection.

Read warning label on compressed air and alcohol product before using.

If you have to use any other solution for medical reasons please contact Zebra for more information.



WARNING! Avoid exposing this product to contact with hot oil or other flammable liquids. If such exposure occurs, unplug the device and clean the product immediately in accordance with these guidelines.

Approved Cleanser Active Ingredients

100% of the active ingredients in any cleaner must consist of one or some combination of the following: isopropyl alcohol, bleach/sodium hypochlorite, hydrogen peroxide or mild dish soap.

Harmful Ingredients

The following chemicals are known to damage the plastics on the RFD5500 and Mobile Computers and should not come in contact with the device: ammonia solutions, compounds of amines or

ammonia; acetone; ketones; ethers; aromatic and chlorinated hydrocarbons; aqueous or alcoholic alkaline solutions; ethanolamine; toluene; trichloroethylene; benzene; carbolic acid and TB-lysoform.

Cleaning Instructions

Do not apply liquid directly to the RFD5500 and Mobile Computers. Dampen a soft cloth or use pre-moistened wipes. Do not wrap the device in the cloth or wipe, but gently wipe the unit. Be careful not to let liquid pool around the display window or other places. Allow the unit to air dry before use.

Special Cleaning Notes

Many vinyl gloves contain phthalate additives, which are often not recommended for medical use and are known to be harmful to the housing of the RFD5500 and Mobile Computers. The RFD5500 should not be handled while wearing vinyl gloves containing phthalates, or before hands are washed to remove contaminant residue after gloves are removed. If products containing any of the harmful ingredients listed above are used prior to handling the RFD5500, such as hand sanitizer that contain ethanolamine, hands must be completely dry before handling the RFD5500 to prevent damage to the plastics.

Materials Required

- Alcohol wipes
- Lens tissue
- Cotton tipped applicators
- Isopropyl alcohol
- Can of compressed air with a tube.

Cleaning Cradle Connectors

To clean the connectors on a cradle:

1. Remove the DC power cable from the cradle.
2. Dip the cotton portion of the cotton tipped applicator in isopropyl alcohol.
3. Rub the cotton portion of the cotton tipped applicator along the pins of the connector. Slowly move the applicator back-and-forth from one side of the connector to the other. Do not let any cotton residue on the connector.
4. All sides of the connector should also be rubbed with the cotton tipped applicator.
5. Spray compressed air in the connector area by pointing the tube/nozzle about ½ inch away from the surface.



CAUTION Do not point nozzle at yourself and others, ensure the nozzle or tube is pointed away from your face.

6. Ensure that there is no lint left by the cotton tipped applicator, remove lint if found.
7. If grease and other dirt can be found on other areas of the cradle, use lint free cloth and alcohol to remove.
8. Allow at least 10 to 30 minutes (depending on ambient temperature and humidity) for the alcohol to air dry before applying power to cradle.

If the temperature is low and humidity is high, longer drying time is required. Warm temperature and dry humidity requires less drying time.

Cleaning Frequency

The cleaning frequency is up to the customer's discretion due to the varied environments in which the mobile devices are used. They may be cleaned as frequently as required. However when used in dirty environments it may be advisable to periodically clean the scanner exit window to ensure optimum scanning performance.

Maintenance

For trouble-free service, observe the tips that follow when using the device.

RFD5500

- Although the device is water and dust resistant, do not expose it to rain or moisture for an extended period of time. In general, treat the device as a pocket calculator or other small electronic instrument.
- Do not clean the device or expose it to rain or moisture when the battery is removed. Without the battery, the device is not water/dust sealed.
- Do not drop the device or subject it to strong impact.
- Protect the device from temperature extremes. Do not leave it on the dashboard of a car on a hot day, and keep it away from heat sources.
- Do not store or use the device in any location that is extremely dusty, damp, or wet.
- Do not use window cleaning solution. Use a soft cloth dampened with a 50/50 solution of isopropyl alcohol and water. See [Cleaning on page 7-1](#).
- Do not allow the solution to form a pool of liquid anywhere on the screen or device.
- Do not use a large amount of solution to cause the device to remain wet.

Battery



WARNING! Do not store the device with the battery installed. Doing so long term may cause irreversible harm to the battery. Always store the battery removed from the device. If a battery is installed during long term storage, it may discharge to point at which it cannot be recovered.

Even when stored separately from device it is important to follow industry standard guidelines. When batteries are stored over a year, battery cell manufacturers advise that some irreversible deterioration in overall battery quality may occur. To minimize this loss, they recommend storing batteries half charged in a dry, cool place between 41° and 77°F (5° and 25°C), the cooler the better. Batteries should be charged to half capacity at least once a year. In order to charge a battery to half capacity, take a fully discharged battery and charge it for two hours. If an electrolyte leakage is observed, avoid any contact with the affected area and properly dispose of the battery.

ActiveSync RNDIS

When using the RFD5500 RFID Sled with a MC65 mobile computer, ActiveSync RNDIS is required to establish a connection with the host PC.

✓ **NOTE** The ActiveSync RNDIS selection is a requirement *Only* for the MC65 mobile computer.

To connect via ActiveSync RNDIS:

1. Tap on the **Start** button.
2. Select *Settings*.
3. Select *Connections*.
4. Select *USB Connect*.
5. The window shown in [Figure 7-1](#) displays. Select **ActiveSync RNDIS**.
6. Select **Connect**.

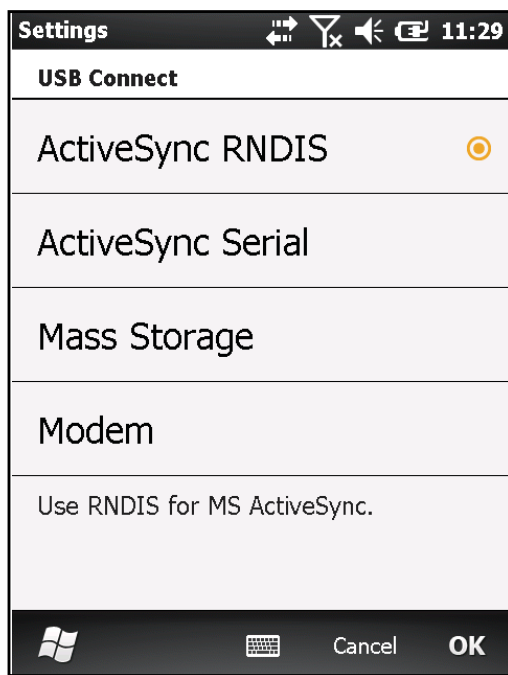

Figure 7-1 *ActiveSync over RNDIS Window*

Initial Sled Removal Error Notification

The first time a RFD5500 RFID Sled is detached from the mobile device, an error notification will appear.

The error notification prerequisite is as follows:

- Mobile computer is clean booted (factory defaults).
- MobileRFID is installed and running.

Select **Don't Send** to safely ignore the error message and to close the dialog box.

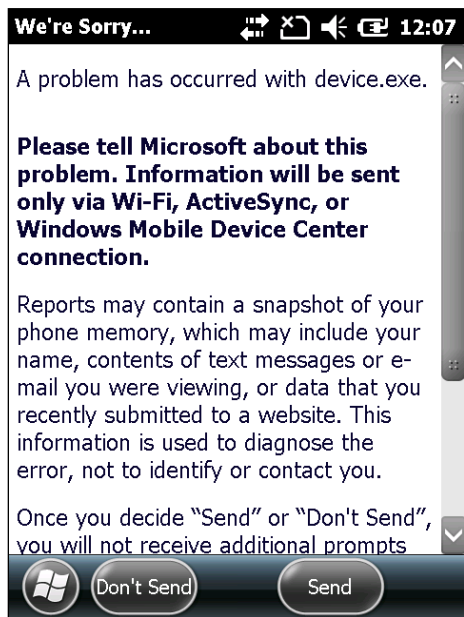

Figure 7-2 Initial Sled Removal Error Notification



NOTE The error notification will only happen once upon the initial RFID Sled removal from the mobile computer.

Troubleshooting

Single Slot USB Cradle

Table 7-1 Troubleshooting the RFD5500 RFID Sled

Symptom	Possible Cause	Action
RFID Sled is not reading tags; RFID operation results in failure.	MobileRFID software is not connected to radio module.	Check MobileRFID for status. If status <i>Stopped</i> , start RFID by selecting: <i>RFID > Settings > Run/Stop</i> . After successful connection with radio module, the status will change to <i>Running</i> . See MobileRFID Run/Stop RFID on page 2-20 .
	Mobile device is not inserted correctly in sled.	Remove and reinsert the Mobile Device securely in the RFID Sled.
	Required firmware was not installed on the Mobile Computer.	Confirm necessary firmware is installed on device.



IMPORTANT When using a single slot cradle with the RFD5500 and mobile computer, only use single slot cradle part number: CRD-MC5X-RCHG1-01.

This single slot cradle can be used for regular MC55, MC65, MC67 (WEH 6.5) operations both with and without the RFD5500 RFID sled.

Table 7-2 Troubleshooting the Single Slot USB Cradle

Symptom	Possible Cause	Action
LEDs do not light when Mobile Computer or spare battery is inserted.	Cradle is not receiving power.	Ensure the power cable is connected securely to both the cradle and to AC power.
	Mobile Computer is not seated firmly in the cradle.	Remove and re-insert the Mobile Computer into the cradle, ensuring it is firmly seated.
	Spare battery is not seated firmly in the cradle.	Remove and re-insert the spare battery into the charging slot, ensuring it is firmly seated.

Table 7-2 Troubleshooting the Single Slot USB Cradle (Continued)

Symptom	Possible Cause	Action
Mobile computer battery is not charging.	Mobile Computer was removed from cradle or cradle was unplugged from AC power too soon.	Ensure cradle is receiving power. Ensure Mobile Computer is seated correctly. Confirm main battery is charging under Start > Settings > System > Power.
	Battery is faulty.	Verify that other batteries charge properly. If so, replace the faulty battery.
	Mobile computer is not fully seated in the cradle.	Remove and re-insert the Mobile Computer into the cradle, ensuring it is firmly seated.
	Extreme battery temperature.	Battery does not charge if ambient temperature is below 0°C (32°F) or above 40°C (104°F).
Spare battery is not charging.	Battery not fully seated in charging slot.	Remove and re-insert the spare battery in the cradle, ensuring it is firmly seated.
	Battery inserted incorrectly.	Re-insert the battery so the charging contacts on the battery align with the contacts on the cradle.
	Battery is faulty.	Verify that other batteries charge properly. If so, replace the faulty battery.
During data communication, no data transmits, or transmitted data was incomplete.	Mobile computer removed from cradle during communications.	Replace Mobile Computer in cradle and retransmit.
	Communication software is not installed or configured properly.	Perform setup as described in User Guide of Mobile Computer.

Cables

Table 7-3 *Troubleshooting the Cables*

Symptom	Possible Cause	Action
Mobile computer battery is not charging.	Mobile computer was disconnected from AC power too soon.	Connect the power cable correctly. Confirm main battery is charging under Start > Settings > System > Power .
	Battery is faulty.	Verify that other batteries charge properly. If so, replace the faulty battery.
	The Mobile Computer is not fully attached to power.	Detach and re-attach the power cable to the Mobile Computer, ensuring it is firmly connected.
During data communication, no data transmits, or transmitted data was incomplete.	Cable was disconnected from Mobile Computer during communications.	Re-attach the cable and retransmit.
	Incorrect cable configuration.	See the system administrator.
	Communication software is not installed or configured properly.	Perform setup as described in the User Guide of Mobile Computer.

Index

A

activesync RNDIS 7-4
antenna 1-2

C

connection
 sample application 3-3
conventions
 notational x

D

demo 3-1
 connection 3-3

E

ESD 2-2

L

locating tags 5-1

M

maintenance 7-3
MobileRFID 2-1
 starting 2-20

P

programming 6-1

R

radio 1-2
RapidRead
 full 4-7
 gieger counter 4-9
 lite 4-5
 options 4-1
 scan 4-11
 tag file 4-3
 write 4-13
 STGIN-96 tab 4-15
RFID components 1-2
 antennas 1-2
 radio 1-2
 tags 1-2
RFID overview 1-1
RFID sample application
 access-filter 3-12
 antenna 3-6
 capabilities 3-4
 exit applicationl 3-23
 factory default 3-8
 filter 3-10
 help menu 3-23
 management menu 3-23
 menu options 3-5, 3-9
 post-filter 3-11
 report trigger 3-22
 RF mode 3-7
 singulation 3-8
 triggers 3-18

S

sample application 3-1
 connection 3-3

service informationxi
starting RFID 2-20
supportxi

T

tag locator 5-2
tags 1-2
 locating 5-1
troubleshooting 7-6
 cables 7-8
 cradle 7-6
 sled 7-6



Zebra Technologies Corporation
Lincolnshire, IL U.S.A.
<http://www.zebra.com>

Zebra and the Zebra head graphic are registered trademarks of ZIH Corp. The Symbol logo is a registered trademark of Symbol Technologies, Inc., a Zebra Technologies company.
© 2015 Symbol Technologies, Inc.



MN000077A04- Revision A - March 2015