

ET1 Enterprise Tablet USER GUIDE



Copyrights

The products described in this document may include copyrighted computer programs. Laws in the United States and other countries preserve for certain exclusive rights for copyrighted computer programs. Accordingly, any copyrighted computer programs contained in the products described in this document may not be copied or reproduced in any manner without the express written permission.

© 2015 Symbol Technologies, Inc. All Rights Reserved

No part of this document may be reproduced, transmitted, stored in a retrieval system, or translated into any language or computer language, in any form or by any means, without the prior written permission.

Furthermore, the purchase of our products shall not be deemed to grant either directly or by implication, estoppel or otherwise, any license under the copyrights, patents or patent applications, except for the normal non-exclusive, royalty-free license to use that arises by operation of law in the sale of a product.

Disclaimer

Please note that certain features, facilities, and capabilities described in this document may not be applicable to or licensed for use on a particular system, or may be dependent upon the characteristics of a particular mobile subscriber unit or configuration of certain parameters. Please refer to your contact for further information.

Trademarks

Zebra and the Zebra head graphic are registered trademarks of ZIH Corp. The Symbol logo is a registered trademark of Symbol Technologies, Inc., a Zebra Technologies company.

Revision History

Changes to the original guide are listed below:

Change	Date	Description
-01 Rev A	08/30/2013	Initial release.
-02 Rev A	02/10/2015	Zebra rebranding.

Contents

Copyrights.....	3
Revision History.....	5
About This Guide.....	11
Documentation Set.....	11
Configurations.....	11
Chapter Descriptions.....	12
Notational Conventions.....	12
Icon Conventions.....	12
Related Documents.....	13
Service Information.....	13
Chapter 1: Getting Started.....	15
Features.....	15
Unpacking.....	17
Setup.....	18
Installing the SIM Card.....	18
Installing the Battery.....	19
Charging the Battery.....	19
Charging the Main Battery.....	19
Charging Temperature.....	20
Charging Spare Batteries.....	20
Powering On the ET1.....	20
WAN Activation.....	21
GSM Activation.....	21
CDMA Activation.....	21
Replacing the Battery.....	21
Replacing the microSD Card.....	22
Handstrap.....	24
Battery Management.....	24
Monitor Battery Usage.....	25
Low Battery Notification.....	25
Battery Optimization.....	25
Changing the Screen Timeout Setting.....	26
Changing the Brightness Setting.....	26
Turning Off the Radios.....	26
Setting the Date and Time.....	27
Display Setting.....	27
Setting the Screen Brightness.....	27
Setting Screen Rotation.....	28
Setting Screen Sleep.....	28
Setting Font Size.....	28
General Sounds Setting.....	28
Chapter 2: Using the ET1.....	31
Home Screen.....	31
Status Bar.....	32
Status Icons.....	32
Notification Icons.....	34
Managing Notifications.....	35

Application Shortcuts and Widgets.....	35
Adding an Application or Widget to the Home Screen.....	35
Moving Items on the Home Screen.....	36
Removing an App or Widget from the Home Screen.....	36
Folders.....	36
Creating Folders.....	36
Naming Folders.....	36
Removing a Folder From the Home Screen.....	37
Home Screen Wallpaper.....	37
Change the Home Screen Wallpaper.....	37
Moving Items on the Home Screen.....	37
Removing Items from the Home Screen.....	38
Using the Touchscreen.....	38
Using the On-screen Keyboard.....	38
Entering Text.....	39
Applications.....	40
Switching Between Recent Applications.....	42
Un-Locking the Screen.....	42
Single User Mode.....	42
MultiUser Mode.....	44
Multiuser Login.....	44
Multiuser Logout.....	45
Resetting the Device.....	45
Performing a Soft Reset.....	45
Performing a Hard Reset.....	45
Wake-up Settings.....	46
Waking the ET1.....	46
File Browser.....	46
Messaging.....	48
Opening Messaging.....	48
Sending a Text Message.....	48
Responding to a Message.....	48
Forwarding a Message.....	48
Locking a Message.....	49
Viewing Message Details.....	49
Deleting a Message Thread.....	49
Messaging Settings.....	49
Chapter 3: Data Capture.....	51
Scanning Modules.....	51
Operational Modes.....	51
Digital Camera.....	51
Laser Scanning.....	52
Scanning Considerations.....	52
Bar Code Capture with Scanning or Scanning/MSR Module.....	52
Bar Code Capture with Integrated Camera.....	54
Bar Code Capture with CS3070 Bluetooth Scanner.....	54
Reading Magnetic Stripe Cards with Scanning/MSR Module.....	56
DataWedge.....	56
Enabling DataWedge.....	57
Disabling DataWedge.....	57
DataWedge Configuration.....	57
Chapter 4: WLAN.....	59

Connecting to a Wi-Fi Network.....	59
Chapter 5: Bluetooth.....	61
Adaptive Frequency Hopping.....	61
Security.....	61
Bluetooth Profiles.....	62
Bluetooth Power States.....	62
Bluetooth Radio Power – Android.....	62
Enabling Bluetooth.....	62
Disabling Bluetooth.....	63
Discovering Bluetooth Devices.....	63
Changing the Bluetooth Name.....	64
Connecting to a Bluetooth Device.....	64
Selecting Profiles on the Bluetooth Device.....	65
Unpairing a Bluetooth Device.....	65
Chapter 6: Photos and Videos.....	67
Taking Photos.....	67
Taking a Panoramic Photo.....	68
Recording Videos.....	68
Camera Settings.....	69
Rear-facing Camera Settings.....	69
Front-facing Camera Settings.....	70
Video Settings.....	70
Video - Rear-facing Camera Settings.....	70
Video - Front-facing Camera Settings.....	71
Viewing Photos and Videos.....	71
Working with Albums.....	72
Share an Album.....	73
Get Album Information.....	73
Deleting an Album.....	74
Working with Photos.....	74
Viewing and Browsing Photos.....	74
Rotating a Photo.....	75
Cropping a Photo.....	75
Setting a Photo as a Contact Icon.....	75
Get Photo Information.....	76
Share a Photo.....	76
Deleting a Photo.....	76
Working with Videos.....	76
Watching Videos.....	77
Sharing a Video.....	77
Deleting a Video.....	77
Chapter 7: Accessories.....	79
ET1 Accessories.....	79
Single-slot USB Docking Cradle.....	80
Four-slot Charge Only Docking Cradle.....	81
Four-Slot Battery Charger.....	82
USB/Charge Cable.....	85
Using the Host USB Module.....	86

Chapter 8: Maintenance and Troubleshooting.....	87
Maintaining the ET1.....	87
Battery Safety Guidelines.....	87
Cleaning Instructions.....	88
Cleaning the ET1.....	89
Housing.....	89
Display.....	89
Camera Window.....	89
Connector Cleaning.....	89
Cleaning Cradle Connectors.....	89
Troubleshooting.....	90
Troubleshooting the ET1 Enterprise Tablet.....	90
Single-slot USB Docking Cradle Troubleshooting.....	92
Four-slot Charge Only Docking Cradle Troubleshooting.....	92
Four-slot Battery Charger Troubleshooting.....	93
USB/Charge Cable Troubleshooting.....	93
 Appendix A: Technical Specifications.....	 95
ET1 Technical Specifications.....	95
Single-slot USB Docking Cradle Technical Specifications.....	97
Four-slot Charge Only Cradle Technical Specifications.....	98
Four-slot Battery Charger Technical Specifications.....	99
USB/Charge Cable Technical Specifications.....	99

About This Guide

This guide provides information on using the ET1 Enterprise Tablet and accessories.



Note: Screens and windows pictured in this guide are samples and can differ from actual screens.

Documentation Set

The documentation set for the ET1 provides information for specific user needs, and includes:



- *ET1 Enterprise Tablet Quick Start Guide* - describes how to set up the ET1 and basic operating instructions.
- *ET1 Enterprise Tablet User Guide* - describes how to use the ET1.
- *ET1 Enterprise Tablet Integrator Guide* - describes how to configure the ET1 and accessories.

Configurations

This guide covers the following configurations:

Configuration	Radios	Display	Memory	Data Capture Options	Operating System
ET1N0	WLAN: 802.11a/b/g/n WPAN: Blue- tooth v2.1 with EDR	7.0" WSVGA Color	1 GB RAM / 4 GB Flash / 4 GB microSD card	camera, Scanning Module, Scan- ning/MSR Mod- ule, optional CS3070	Android-based, Android Open- Source Project 4.1.1
ET1N2	WLAN: 802.11a/b/g/n WPAN: Blue- tooth v2.1 with EDR WWAN: HSDPA / CDMA	7.0" WSVGA Color	1 GB RAM / 4 GB Flash / 4 GB microSD card	camera, Scanning Module, Scan- ning/MSR Mod- ule, optional CS3070	Android-based, Android Open- Source Project 4.1.1

Software Versions

To determine the current software versions touch  >  **About device**.

- **Serial number** - Displays the serial number.
- **Model number**- Displays the model number.
- **Android version** - Displays the operating system version.
- **Kernel version** - Displays the kernel version number.
- **Build number** - Displays the software build number.

Chapter Descriptions

Topics covered in this guide are as follows:

- *Getting Started on page 15* provides information on getting the ET1 up and running for the first time.
- *Using the ET1 on page 31* provides basic instructions for using the ET1, including powering on and resetting the ET1.
- *Data Capture on page 51* provides information for capturing bar code data using the internal camera and optional scan modules and Bluetooth scanner.
- *WLAN on page 59* provides information for configuring Wi-Fi.
- *Bluetooth on page 61* provides information for configuring Bluetooth.
- *Photos and Videos on page 67* explains how to take photos, capture videos and video images in the Gallery application.
- *Accessories on page 79* describes the available accessories and how to use them with the ET1.
- *Maintenance and Troubleshooting on page 87* includes instructions on cleaning and storing the ET1, and provides troubleshooting solutions for potential problems during ET1 operation.
- *Technical Specifications on page 95* provides the technical specifications for the ET1.

Notational Conventions

The following conventions are used in this document:

- *Italics* are used to highlight the following:
 - Chapters and sections in this and related documents
 - Icons on a screen.
- **Bold** text is used to highlight the following:
 - Dialog box, window, and screen names
 - Drop-down list and list box names
 - Check box and radio button names
 - Button names on a screen.
- Bullets (•) indicate:
 - Action items
 - Lists of alternatives
 - Lists of required steps that are not necessarily sequential
- Sequential lists (for example, lists that describe step-by-step procedures) appear as numbered lists.

Icon Conventions

The documentation set is designed to give the reader more visual clues. The following graphic icons are used throughout the documentation set. These icons and their associated meanings are described below.



Warning: The word WARNING with the associated safety icon implies information that, if disregarded, could result in death or serious injury, or serious product damage.



Caution: The word CAUTION with the associated safety icon implies information that, if disregarded, may result in minor or moderate injury, or serious product damage.



Note: NOTE contains information more important than the surrounding text, such as exceptions or preconditions. They also refer the reader elsewhere for additional information, remind the reader how to complete an action (when it is not part of the current procedure, for instance), or tell the reader where something is located on the screen. There is no warning level associated with a note.

Related Documents

- *ET1 Enterprise Tablet Quick Start Guide*, p/n MN000021A01-xx
- *ET1 Enterprise Tablet Regulatory Guide*, p/n 72-148509-xx
- *ET1 Enterprise Tablet Integrator Guide*, p/n MN000022A01-xx
- *Symbol CS3000 Series Scanner Product Reference Guide*, p/n 72E-136088-xx
- *MSP Client Software Guide*, p/n 72E-128805-xx
- *MSP 4.2 Release Notes*, p/n 72E-100160-xx.

For the latest version of this guide and all guides, go to: <http://www.zebra.com/support>

Service Information

If you have a problem with your equipment, contact Zebra Customer Support Center for your region. Contact information is available at: <http://www.zebra.com/support>.

When contacting Zebra Customer Support Center, have the following information available:

- Serial number of the unit (found on the manufacturing label)
- Model number or product name (found on the manufacturing label)
- Software type and version number

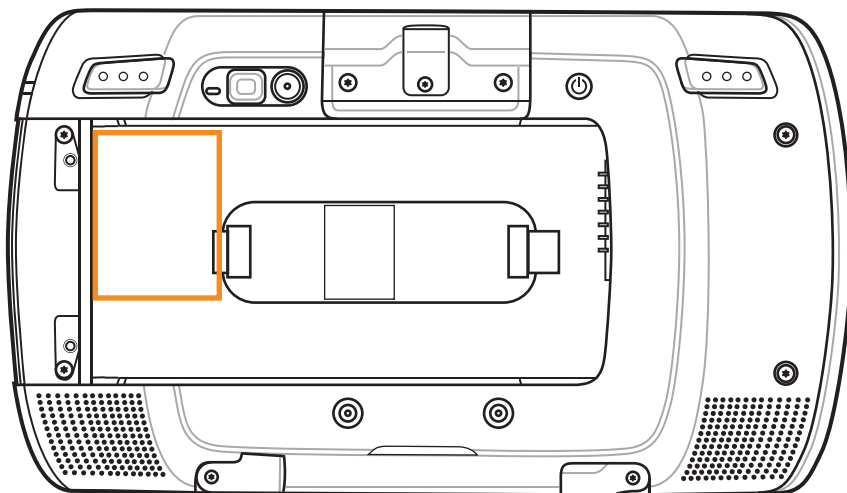

Zebra responds to calls by email or telephone within the time limits set in support agreements.

If the Zebra Customer Support Center cannot solve the problem, you may need to return the equipment for servicing. The Support Center provides the specific directions. Zebra is not responsible for any damages incurred during shipment if the approved shipping container is not used. Shipping the units improperly can possibly void the warranty.

If you purchased your product from a Zebra business partner, contact that business partner for support.

Chapter 1

Getting Started

This chapter provides the features of the ET1 and explains how to set it up for the first time.

Features

Figure 1: Front View

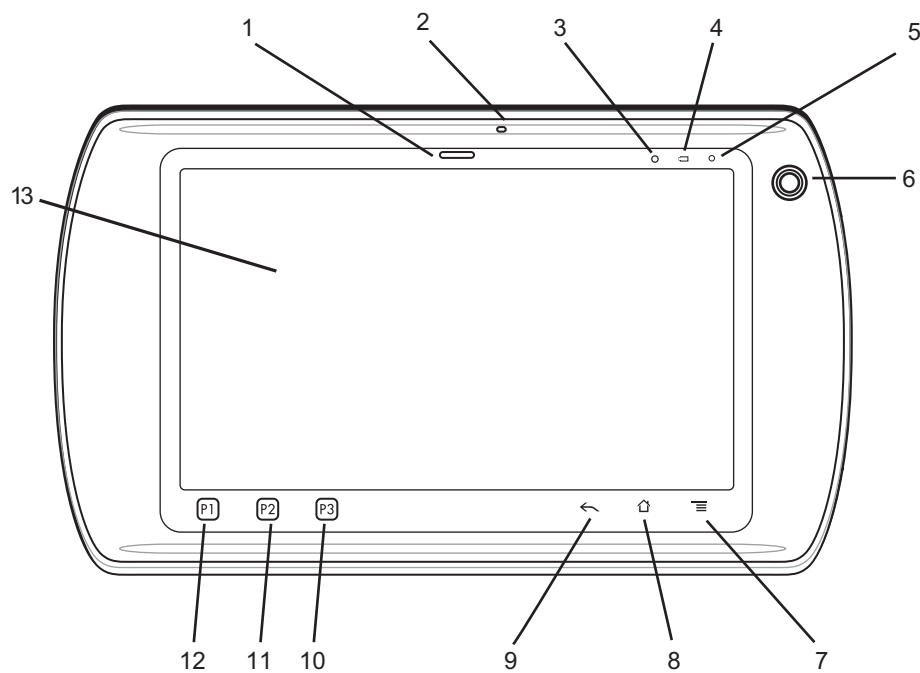
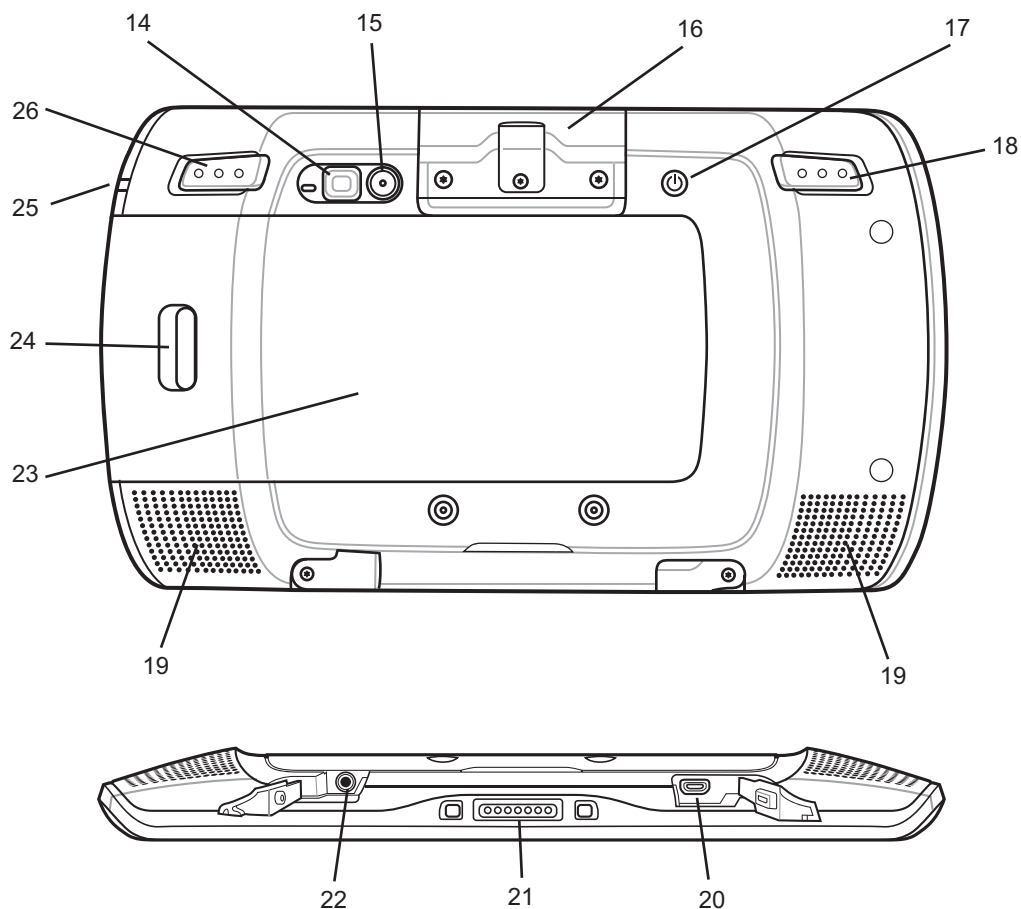



Figure 2: Back View**Table 1: Features**

Number	Item	Function
1	Decode LED	Indicates decode functionality. Lights red when scanning in process. Lights green indicating a successful decode.
2	Microphone	Use for making voice recordings.
3	Light Sensor	Determines ambient light for controlling display backlight intensity.
4	Battery Charge LED	Indicates battery charge state.
5	Communication LED	User programmable.
6	Front-facing Camera	Use for capturing a front view picture. Use for making video calls with third-party video applications.
7	☰	Menu Button — Opens a menu with items that affect the current screen or application.
8	🏠	Home Button — Displays the Home screen with a single touch. Displays recently used applications when held for a short period.

Table continued...

Number	Item	Function
9		Back Button — Displays the previous screen. Closes the keyboard if the on-screen keyboard is open.
10	P3	Launches the Search application (default). User configurable.
11	P2	Increases the volume (default). User configurable.
12	P1	Decreases the volume (default). User configurable.
13	Touch Screen	Displays all information required to operate the ET1.
14	Camera Flash	Provides illumination for rear-facing camera.
15	Rear-facing Camera	Takes photos, videos, and captures bar code data.
16	USB Host Expansion Module	Provides USB host connection to a peripheral.
	Scanning Module	Provides 1D and 2D bar code scanning.
	Scanning/MSR Module	Provides 1D and 2D bar code scanning and magnetic stripe card reading.
17	Power Button	<p>Press and hold to turn on the ET1. Press to turn on or off the screen. Press and hold to select one of these options:</p> <ul style="list-style-type: none"> • Silent mode - The device is set to vibrate mode; all sounds are disabled except for alarms. • Airplane mode - Disable all wireless connections. • Battery swap - Shut down the device when replacing the battery. • Reset - Reboot the ET1 when software stops responding. • Power off - Turn off the ET1.
18	Left Scan/Action Button	Opens the scan application (default). Programmable.
19	Speakers	Provides audio output for video and music playback.
20	HDMI Output Connector	Provides HDMI audio and video signals to an HDMI compatible monitor or television.
21	I/O Connector	Provides power to the device from cradles and cables and provides USB client and host communications.
22	Headset Jack	Connects to mono headphones (3-wire, 2.5 mm plug).
23	Battery	Provides operating power to the ET1.
24	Battery Latch	Releases the battery for removal.
25	Side LED	Indicates battery charge state.
26	Right Scan/Action Button	Opens the scan application (default). Programmable.

Unpacking

Carefully remove all protective material from the ET1 and save the shipping container for later storage and shipping.

Verify the following items are in the box:

- ET1 Enterprise Tablet with 4 GB micro secure digital (SD) card installed
- Lithium-ion battery
- Quick Start Guide
- Regulatory Guide.

Inspect the equipment for damage. If any equipment is missing or damaged, contact the Zebra Customer Support Center immediately. See [Service Information on page 13](#) for contact information.

Setup

To start using the ET1 for the first time:

- Install SIM card in an ET1N2 with GSM (optional).
- Install the battery.
- Charge the ET1.
- Power on the ET1.
- Activate the ET1N2 on a mobile data network (optional).

Installing the SIM Card



Note: ET1N2 only.

The ET1N2 requires an activated SIM card. Obtain the card from a service provider.

Procedure:

- 1 Lift the access door.

Figure 3: Installing SIM Card

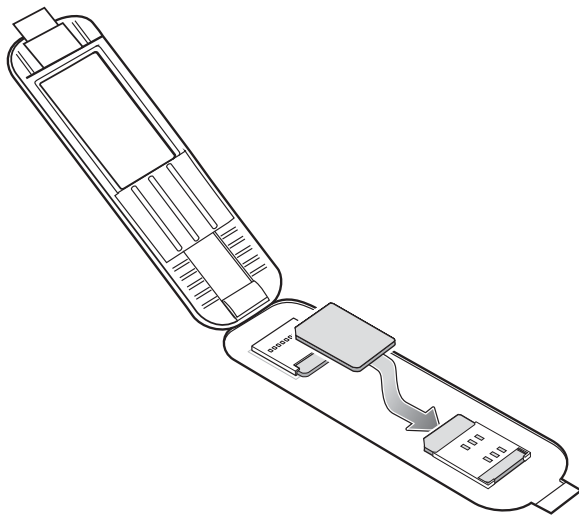

- 2 Insert SIM card into the SIM holder with the contacts facing down and the cut edge facing away from the holder.
- 3 Close the access door.

Installing the Battery



Note: Ensure that the correct battery is used with the ET1. On the ET1N0 use either the 4620 mAh battery, p/n 82-149690-xx or the 5640 mAh battery, p/n 82-158261-xx. On the ET1N2 use only the 5640 mAh battery, p/n 82-158261-xx.

To install the battery:

Procedure:

- 1 Align the tracks on the side of the battery with the rails in the battery compartment.
- 2 Push the battery in until the battery release latch snaps into place.
- 3 If the battery is charged, press and hold the Power button for two seconds until the splash screen appears.

Figure 4: Inserting the Battery

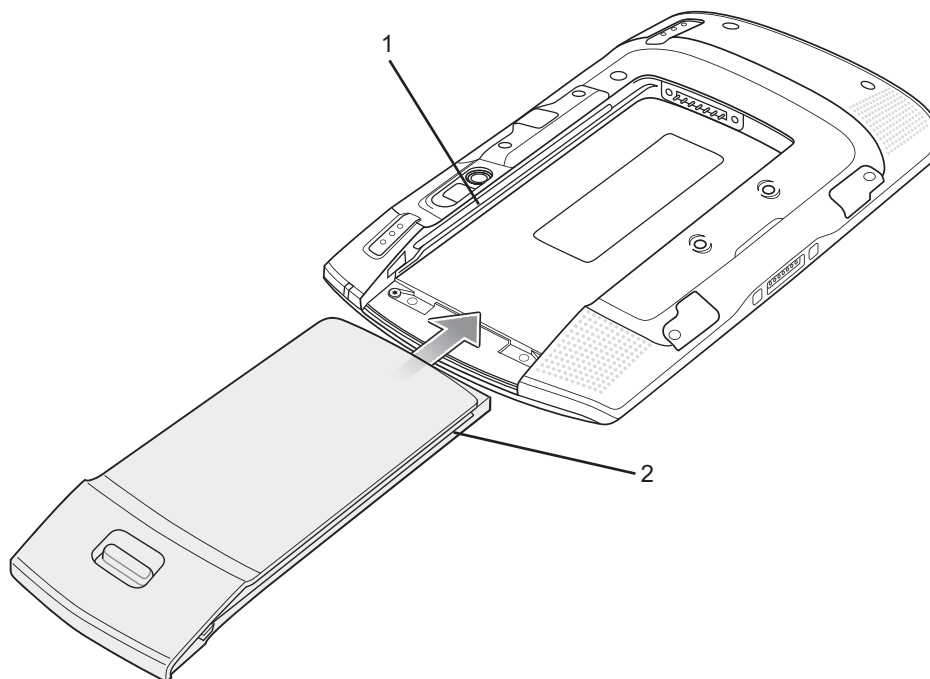

- 1 Rails
- 2 Battery Tracks

Charging the Battery



Caution: Ensure that you follow the guidelines for battery safety described in [Battery Safety Guidelines on page 87](#).

Charging the Main Battery

Before using the ET1 for the first time, charge the main battery until the Battery Charge light emitting diode (LED) turns solid green (see [Table 2: Battery Charge LED Status on page 20](#) for charge status indications). To charge the ET1, use a cable or a cradle with the appropriate power supply. For information about the accessories available for the ET1, see [Accessories on page 79](#).

The ET1 is equipped with a memory backup battery that automatically charges from the fully-charged main battery. When using the ET1 for the first time, the backup battery requires approximately 40 hours to fully charge. This is also true any time the backup battery is discharged, which occurs when the main battery is removed for several hours. The backup battery retains random access memory (RAM) data in memory for at least 15 minutes (at room temperature)

when the ET1's main battery is removed, when Battery swap feature is used. When the ET1 reaches a very low battery state, the combination of main battery and backup battery retains RAM data in memory for at least 36 hours.

For cable and cradle setup and charging procedures see [Accessories on page 79](#).

- USB/Charge Cable
- Single-slot USB Docking Cradle
- Four-slot Charge Only Docking Cradle.

To charge the main battery:

- 1 Connect the charging accessory to the appropriate power source. See [Accessories on page 79](#) for more information.
- 2 Insert the ET1 into a cradle or attach to a cable. The ET1 begins charging. The Battery Charge LEDs blink yellow while charging, then turns solid green when fully charged. See [Table 2: Battery Charge LED Status on page 20](#) for charging indications.

The battery charges in less than six hours.

Table 2: Battery Charge LED Status

Status	Indications
Off	ET1 is not inserted correctly in the cradle. ET1 is not connected to a power source. Charger or cradle is not powered.
Slow Blinking Yellow (3 blinks every 2 seconds)	ET1 is charging.
Solid Green	Charging complete.
Fast Blinking Yellow (2 blinks/second)	Charging error, e.g.: <ul style="list-style-type: none"> • Temperature is too low or too high. • Charging has gone on too long without completion (typically eight hours).
Flashes Yellow three times when Power button pressed	Critical battery state. Battery too low to boot device.
Fast Blinking Yellow (when Power button pressed)	Battery over-temperature condition. Device shuts down. Battery will not charge until temperature returns to normal operating value.

Charging Temperature

Charge batteries in temperatures from 0 °C to 40 °C (32 °F to 104 °F). Note that charging is intelligently controlled by the ET1. To accomplish this, for small periods of time, the ET1 or accessory alternately enables and disables battery charging to keep the battery at acceptable temperatures. The ET1 or accessory indicates when charging is disabled due to abnormal temperatures via its LED. See [Table 2: Battery Charge LED Status on page 20](#).

Charging Spare Batteries

See [Accessories on page 79](#) for information on using accessories to charge spare batteries.

Powering On the ET1

Press the Power button until the Battery Charge LED flashes three times. The splash screen displays for about a minute as the ET1 initializes its flash file system. Note that these windows also appear upon reset.

WAN Activation



Note: ET1N2 only.

In order to use the WAN radio for data communication, the ET1N2 must be activated on the service provider's network. By default, the ET1N2 is configured for a GSM network. To activate on a CDMA network, manual configuration is required.

Refer to the *ET1 Enterprise Tablet Integrator Guide* for detailed WAN configuration information.

GSM Activation

When the ET1N2 turns on it automatically configures for the network. If the SIM card requires a PIN, the PIN screen appears. Enter the PIN and touch **OK**.

CDMA Activation

Prior to using the ET1N2 on a CDMA network, the ET1 must be registered with the service provider. Contact the service provider to set up an account and provide the MEID number (located under the battery).

By default, the ET1N2 is configured for a GSM network. To activate on a CDMA network:

Procedure:

- 1 Touch .
- 2 Touch **More...**
- 3 Touch **Mobile networks**.
- 4 Touch **Technology preferences**.
- 5 Touch **Network mode**.
- 6 In the **Network mode** menu, select either **Sprint** or **Verizon**. The ET1 switches the modem firmware and the Activation Dialog box appears.

Figure 5: Activation Screen



- 7 Touch **Activate**. The ET1N2 begins the activation process. If the activation is unsuccessful, contact the service provider.

Replacing the Battery

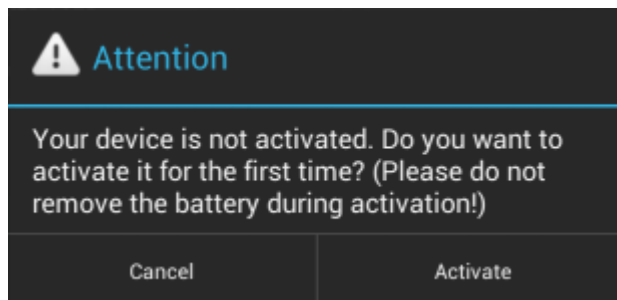

Caution:

Do not remove the microSD card while in Battery Swap mode.

Ensure that the Battery Swap mode procedures are followed, otherwise the backup battery will deplete quickly and on the ET1N2, SIM card data corruption might occur.

To replace the battery:

Procedure:

- 1 Press the Power button until the menu displays.
- 2 Touch **Battery Swap**. The Scan LED lights red.
- 3 Wait until the Scan LED turns off.
- 4 Press thumb against the side of the ET1 and battery. Using the index and middle fingers, move the battery release latch toward thumb.
- 5 Pull the battery out of the battery compartment.

Figure 6: Removing the Battery

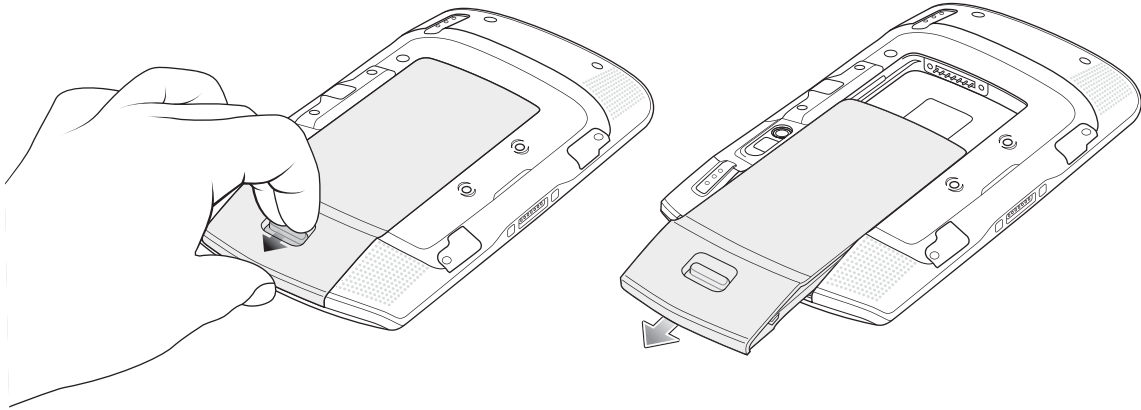

- 6 Align the tracks on the side of the replacement battery with the rails in the battery compartment.
- 7 Push the battery in until the battery release latch snaps into place.
- 8 Press the Power button to turn on the ET1.

Replacing the microSD Card



Caution:

For proper electrostatic discharge (ESD) precautions to avoid damaging the SD card. Proper ESD precautions include, but not limited to, working on an ESD mat and ensuring that the user is properly grounded.

Changing the microSD card can change the functionality of the ET1.

To replace the microSD card:

Procedure:

- 1 Press the Power button until the menu displays.
- 2 Touch **Power off**.
- 3 Touch **OK**.
- 4 Wait for the ET1 to power off completely.
- 5 Press thumb against the side of the ET1 and battery. Using the index and middle fingers, move the battery release latch toward thumb.
- 6 Pull the battery out of the battery compartment.
- 7 Lift the access door.

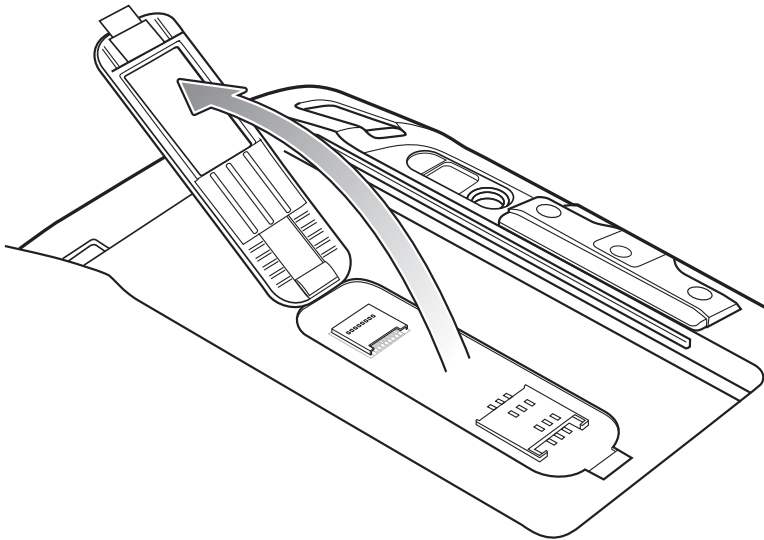
Figure 7: Lift Access Door

- 8 Remove the microSD card from the card holder.
- 9 Align the replacement microSD card with the card holder. Ensure that the contacts on the card are facing down and toward the card holder.
- 10 Insert the microSD card into the card holder.

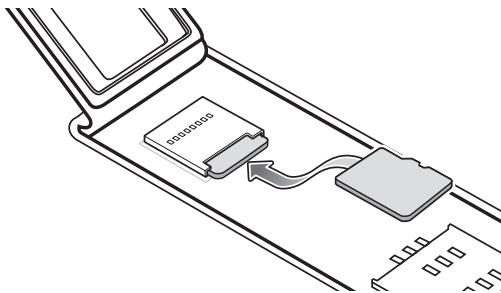
Figure 8: Insert microSD Card

- 11 Close the access door.

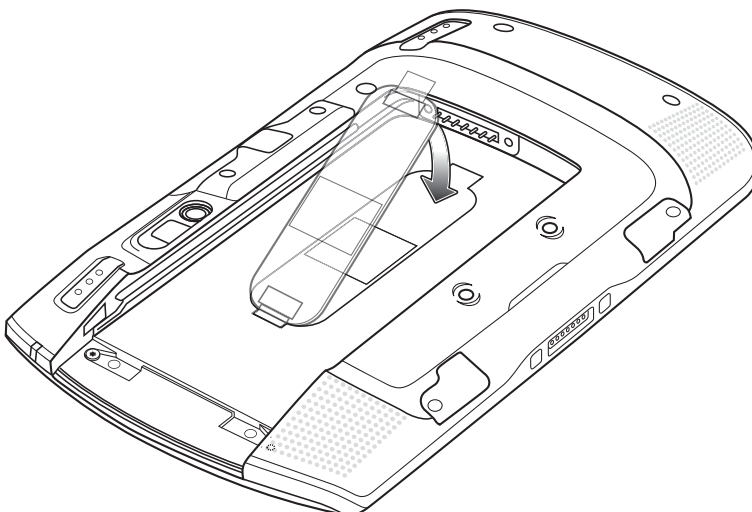
Figure 9: Close Access Door

- 12 Align the tracks on the side of the replacement battery with the rails in the battery compartment.

13 Push the battery in until the battery release latch snaps into place.

14 Press the Power button to turn on the ET1.

Handstrap

Use the optional 360-degree rotatable handstrap to securely hold the ET1 while working. Refer to the ET1 Enterprise Tablet Integrator Guide for information on installing the handstrap.

Rotate the handstrap for landscape or portrait viewing.

Figure 10: Rotate Handstrap 360 Degrees

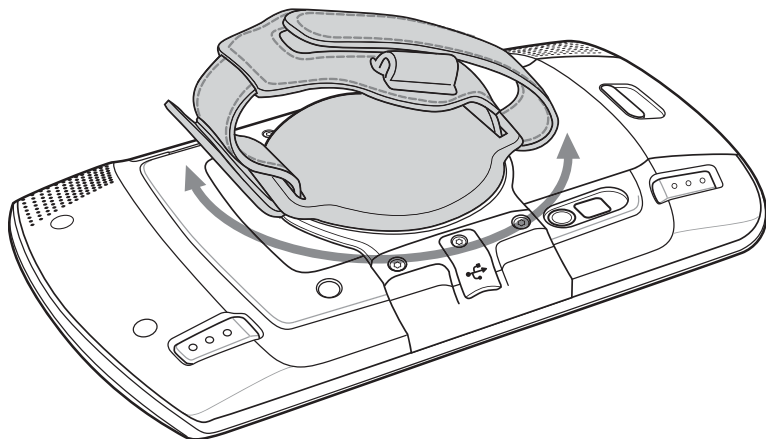

Insert hand into the handstrap and tighten strap.

Figure 11: Hand in Handstrap

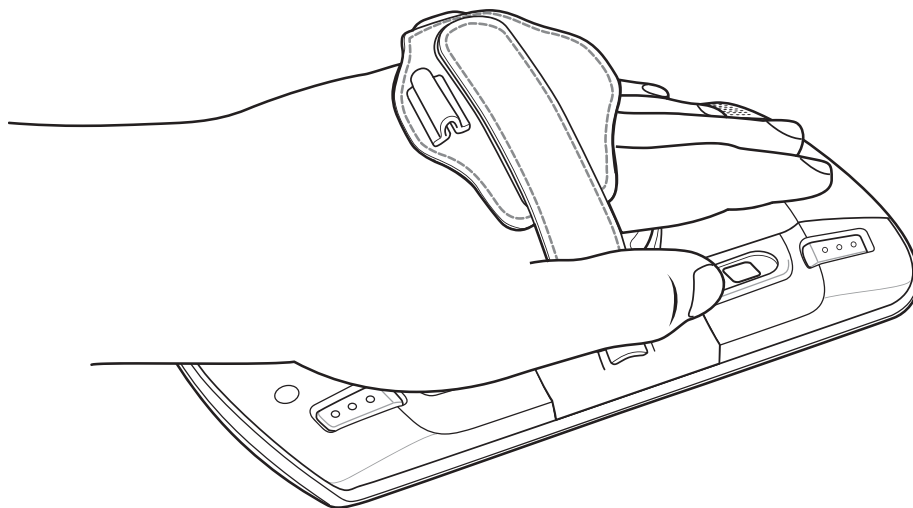



Battery Management



Note:

Prior to checking the battery charge level, remove the ET1 from any AC power source (cradle or cable).

To check the charge status of the main battery, touch  >  **About device** > **Status**.

Battery status indicates that the battery is discharging and **Battery level** lists the battery charge (as a percentage of fully charged).

Monitor Battery Usage

The **Battery** screen lists which applications consume the most battery power. Also use it to turn off applications that were downloaded if they are consuming too much power.

Touch  >  **Battery**.

Figure 12: Battery Screen

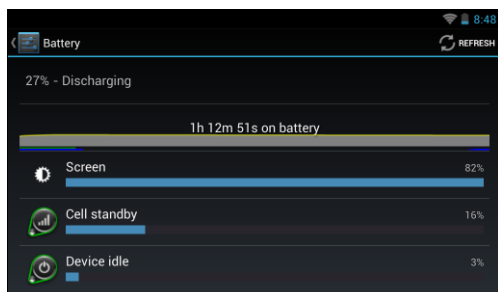

The **Battery** screen lists the applications using the battery. The discharge graph at the top of the screen shows the rate of the battery discharge since last charged (short periods of time when connected to a charger are shown as thin green lines at the bottom of the chart), and how long it has been running on battery power.

Touch an application in the **Battery** screen to display details about its power consumption. Different applications display different information. Some applications include buttons that open screens with settings to adjust power use.

Low Battery Notification

When the battery charge drops below 20%, the ET1 displays a notice to connect the ET1 to power.

Figure 13: Low Battery Notification

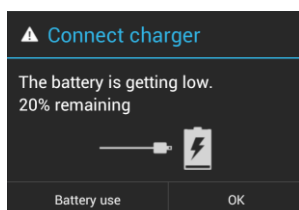

The user should replace the battery or charge the ET1 using one of the charging accessories.

When the battery charge drops below 10%, the ET1 goes into critical suspend mode to save data. The screen turns off. If the Power button is pressed, the Charge LED flashes yellow.

The user must replace the battery or charge the ET1 using one of the charging accessories to retain data.

Battery Optimization

Observe the following battery saving tips:



- Leave the ET1 connected to AC power at all times when not in use.
- Set the screen to turn off after a short period of non-use.
- Reduce screen brightness.

- Turn off all wireless radios when not in use. Note that the global positioning system (GPS) receiver is only turned on when a GPS application is using GPS.
- Turn off automatic syncing for Email, Calendar, Contacts and other applications.
- Use the **Power Control** widget to check and control the status of radios, the screen brightness, and syncing.
- Minimize use of applications that keep the ET1 from suspending, for example, music, GPS and video applications.

Changing the Screen Timeout Setting

To set the ET1 to turn off after a short period of non-use:



Procedure:

- 1 Touch .
- 2 Touch  **Display**.
- 3 Touch **Sleep**.
- 4 Select a value from the **Sleep** window. Options:
 - **15 seconds**
 - **30 seconds**
 - **1 minute** (default)
 - **2 minutes**
 - **5 minutes**
 - **10 minutes**
 - **30 minutes**
- 5 Touch .

Changing the Brightness Setting

To change the brightness setting in order to conserve more battery power:

Procedure:

- 1 Touch .
- 2 Touch  **Display**.
- 3 Touch **Brightness**.
- 4 If the **Automatic Brightness** checkbox is set, touch the checkbox to disable.
- 5 Move the slider to the left to reduce the brightness.
- 6 Touch **OK**.
- 7 Touch .

Turning Off the Radios

To turn off all the radios:

Procedure:



- 1 Press the Power button until the menu appears.
- 2 Touch **Airplane mode**. The airplane icon  appears in the Status bar indicating that all the radios are off.

Setting the Date and Time

The date and time are automatically synchronized using an NTP server when the ET1 is connected to a wireless network. The user is only required to set the time zone. Refer to the *ET1 Enterprise Tablet Integrator Guide* for more information on configuring the NTP server connection.

To set the date and time:

Procedure:

- 1 Touch .
- 2 Touch  **Date & time**.
- 3 Touch **Select time zone**.
- 4 Touch the time zone for the current location.
- 5 Touch .

Display Setting

The **Display** settings screen allows the user to set the following options:

- Brightness
- Screen rotation
- Sleep time
- Font size

Setting the Screen Brightness

To set the screen brightness:

Procedure:

- 1 Touch .
- 2 Touch  **Display**.
- 3 Touch **Brightness**.

Figure 14: Brightness Dialog Box

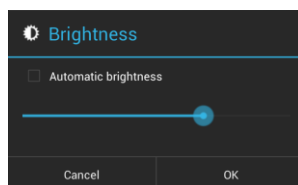



- 4 In the **Brightness** dialog box, check the **Automatic brightness** checkbox to set the ET1 to automatically adjust the brightness using the built-in light sensor. Uncheck the checkbox to set the brightness manually. Use the slider to set a brightness level.
- 5 Touch **OK**.
- 6 Touch .

Setting Screen Rotation

The user can set the ET1 screen to rotate 90 degrees left or right.



Procedure:

- 1 Touch .
- 2 Touch  **Display**.
- 3 In the **Display settings** screen, check **Auto-rotate screen** to set the ET1 to automatically switch orientation when the ET1 is rotated.
- 4 Touch .

Setting Screen Sleep

The user can set the ET1 display to turn off after a period of inactivity.



Procedure:

- 1 Touch .
- 2 Touch  **Display**.
- 3 Touch **Sleep**.
- 4 In the **Sleep** menu, select one of the sleep values.
 - **15 seconds**
 - **30 seconds**
 - **1 minute** (default)
 - **2 minutes**
 - **5 minutes**
 - **10 minutes**
 - **30 minutes**
- 5 Touch .

Setting Font Size

To set the size of the font in system applications:

Procedure:

- 1 Touch .
- 2 Touch  **Display**.
- 3 Touch **Font size**.
- 4 In the **Font size** menu, select one of the font size values.
 - **Small**
 - **Normal**
 - **Large**
 - **Huge**
- 5 Touch .

General Sounds Setting



Use the **Sounds** settings to configure media and alarm volumes. Touch  >  >  **Sounds**.

Figure 15: Sounds Screen



- **Volumes** — Use to change the volume of media, ringtones and notifications and alarms.

Figure 16: Volumes Dialog Box

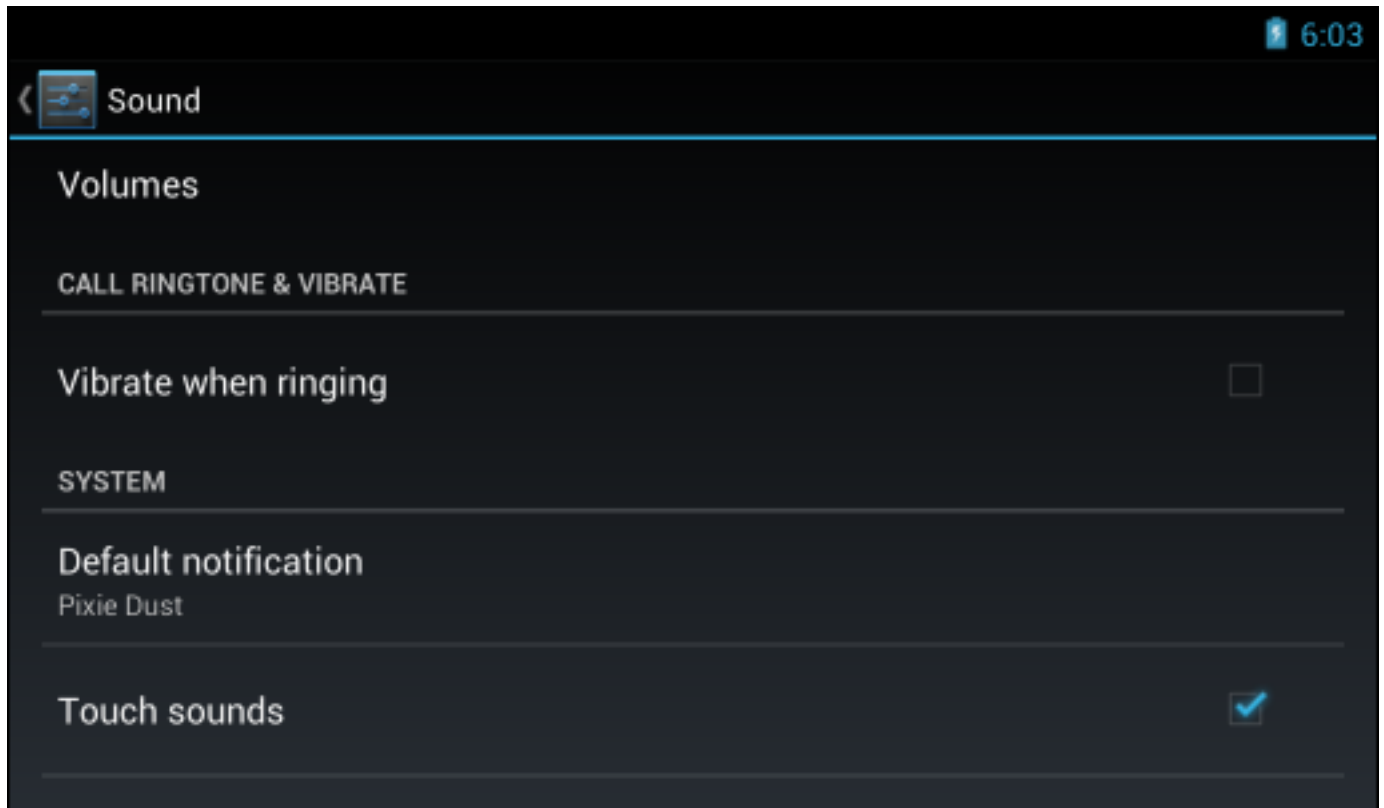
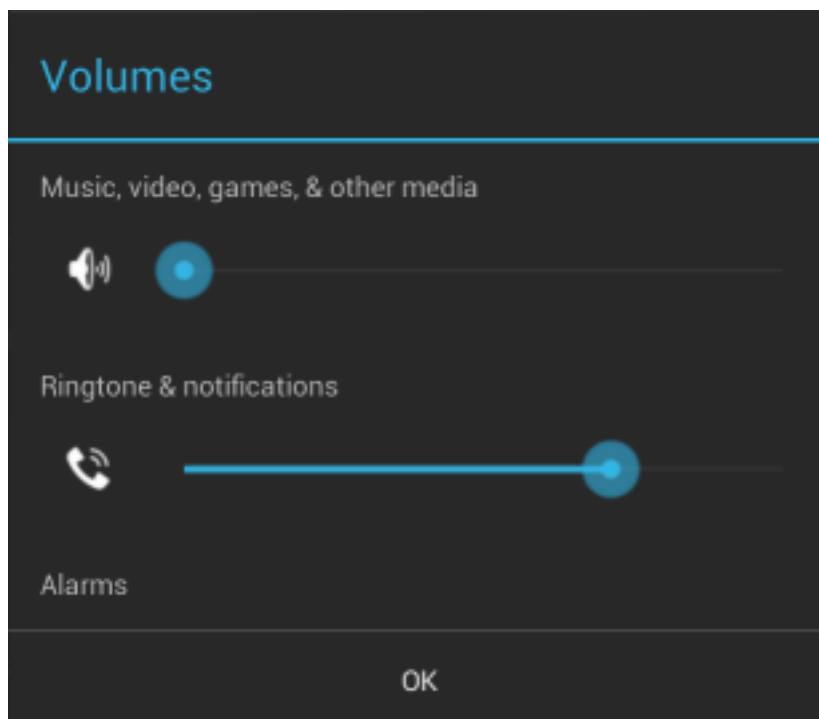

- **Call Ringtone and Vibrate**

- **Vibrate when ringing** - Check to make the ET1 vibrate when a call is received.
- **System**
 - **Default notification** - Touch to select a sound to play for all system notifications.
 - **Touch sounds** - Check to play a sound when making screen selections.
 - **Screen lock sounds** - Check to play a sound when locking and unlocking the screen.
 - **Vibrate on touch** - Check to have the ET1 vibrate when touching soft keys and on certain screen interactions.

Chapter 2

Using the ET1

This chapter describes the screens, status and notification icons, and controls on the ET1, and provides basic instructions for using the ET1.

Home Screen

The Home screen displays when the ET1 turns on. Depending upon the configuration, the Home screen might appear different. Contact your system administrator for more information.



After a suspend or screen time-out, the Home screen displays with the lock icon. Touch and slide  up until it touches . For screen locking information see [Un-Locking the Screen on page 42](#).

Figure 17: Home Screen

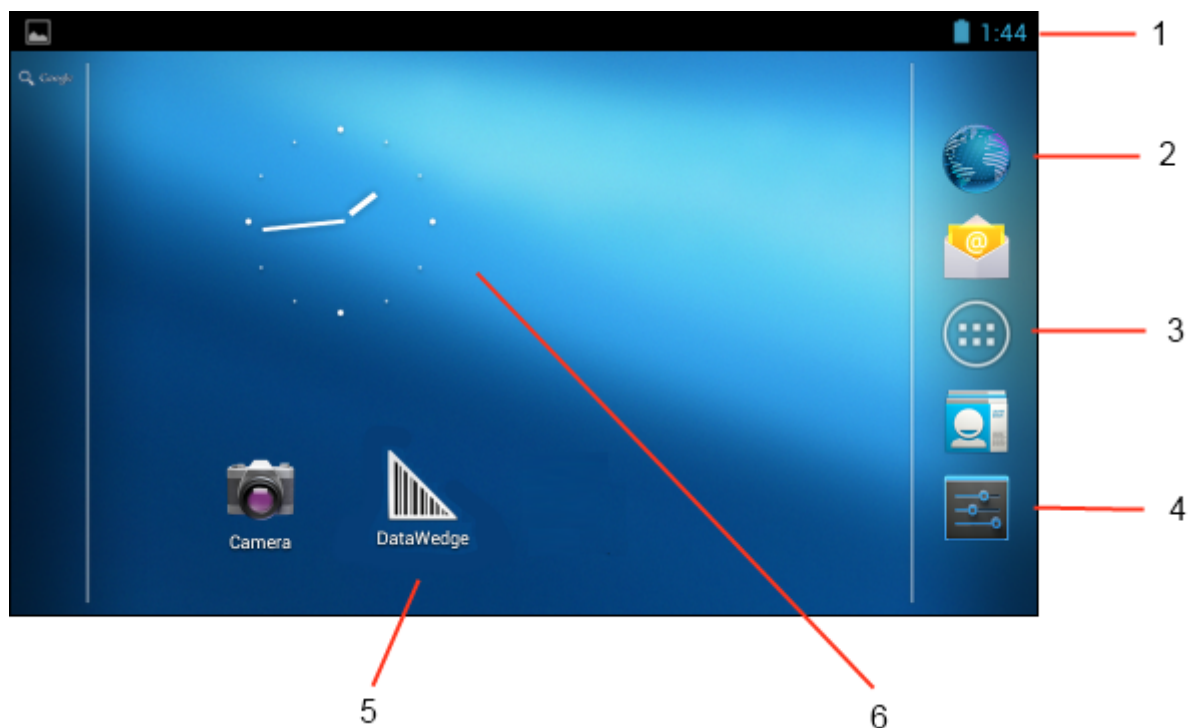

Table 3: Home Screen Items

Item	Description
1 — Status Bar	Displays the time, status icons (right side), and notification icons (left side). For more information see Status Icons on page 32 and Managing Notifications on page 35 .
2 — Browser Icon	Opens the Browser application.
3 — All Apps Icon	Opens the APPS window.
4 — Settings Icon	Opens the Settings window.
5 — Shortcut Icons	Opens applications installed on the ET1. See Application Shortcuts and Widgets on page 35 for more information.
6 — Widgets	Launches stand-alone applications that run on the Home screen. See Application Shortcuts and Widgets on page 35 for more information.

The Home screen provides four additional screens for placement of widgets and shortcuts. Swipe the screen left or right to view the additional screens.

Status Bar

The Status bar displays the time, notification icons (left side) and status icons (right side).

Figure 18: Notification and Status Icons

- 1 Notification icons
- 2 Status icons.

If there are more notifications than can fit in the Status bar,  displays indicating that more notifications exist. Open the Notifications panel to view all notifications and status.

Status Icons

[Table 4: Status Icons on page 32](#) lists Status icons that might appear in the Status Bar.

Table 4: Status Icons



Icon	Description
	Indicates that GPS is on.
	Indicates that the ET1 is receiving location data from GPS.
	Indicates that Bluetooth is on.

Table continued...

















Icon	Description
	Indicates that the ET1 is connected to a Bluetooth device.
	Indicates that the Alarm is active.
	Indicates that all sounds except media and alarms are silenced and vibrate mode is active.
	Indicates that the ringer is silenced.
	Connected to a Wi-Fi network.
	No Wi-Fi signal.
	Indicates that the battery charge is very low.
	Indicates that the battery charge is low.
	Indicates that the battery is partially drained.
	Indicates that the battery is fully charged.
	Indicates that the battery is charging.
	Indicates that the Airplane Mode is active. All radios are turned off.
	Mobile network signal strength (ET1N2 only).
	No mobile network signal (ET1N2 only).
	Connected to an EDGE or EVD0 network (ET1N2 only).
	Connected to a 3G network (ET1N2 only).
	Connected to an HSPA network (ET1N2 only).
	Connected to a 1X CDMA network (ET1N2 only).
	Roaming from a network (ET1N2 only).

















Table continued...

Icon	Description
	No SIM card installed (ET1N2 only).

Notification Icons

Table 5: Notification Icons on page 34 lists the possible notification icons. See *Managing Notifications on page 35* for information about responding to these notifications. In addition to these icons, installed applications may display their own notification icons.

Table 5: Notification Icons

Icon	Description
	Indicates that more notifications are available for viewing.
	Indicates that data is syncing.
	Indicates an upcoming event.
	Indicates that an open Wi-Fi network is available.
	Indicates that a song is playing.
	Indicates that a problem with sign-in or sync has occurred.
	Indicates that the ET1 is uploading data.
	Indicates that the microSD card is almost full.
	Indicates that the ET1 is downloading data when animated and download is complete when static.
	Indicates that the ET1 is connected via USB cable.
	Indicates that the ET1 is connected to or disconnected from virtual private network (VPN).
	Preparing SD card.
	Indicates that USB debugging is enabled on the ET1.
	Indicates that the MultiUser feature is enabled.
	Indicates that a new user is logging in.
	Indicates that the ET1 has received a text message (ET1N2 only).

Managing Notifications

Notification icons report the arrival of new messages, calendar events, and alarms, as well as ongoing events. When a notification occurs, an icon appears in the Status bar with a brief description. See [Table 5: Notification Icons on page 34](#). Open the Notifications Panel to view a list of all the notifications.

To open the Notification Panel drag the Status bar down from the top of the screen.

Figure 19: Notification Panel

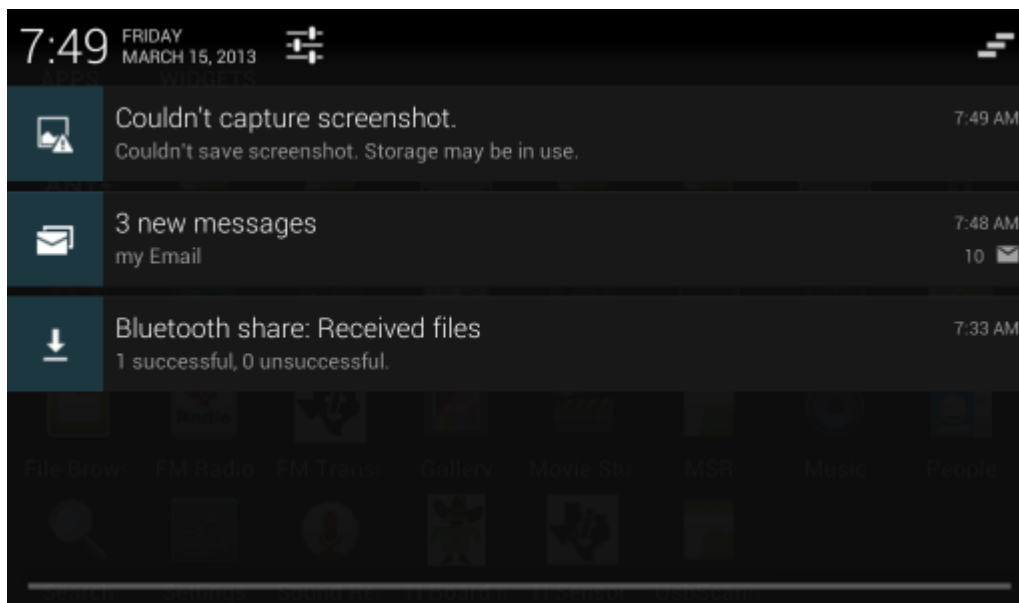

To respond to a notification, open the Notifications Panel and then touch a notification. The Notifications Panel closes and the subsequent activity is dependent on the notification.

To clear all notifications, open the Notifications Panel and then touch . All event-based notifications are removed. Ongoing notifications remain in the list.

To close the Notification Panel, drag the bottom of the Notifications Panel to the top of the screen or touch .

Application Shortcuts and Widgets

Application shortcuts placed on the Home screen allow quick and easy access to applications. Widgets are self-contained applications placed on the Home screen to access frequently used features.

Adding an Application or Widget to the Home Screen

Procedure:

- 1 Go to the desired Home screen.
- 2 Touch .
- 3 Swipe right, if necessary, to find the application icon or widget.
- 4 Touch and hold the icon or widget until the Home screen appears.
- 5 Position the icon on the screen and then release.

Moving Items on the Home Screen

Procedure:

- 1 Touch and hold the item until it floats on the screen.
- 2 Drag the item to a new location. Pause at the edge of the screen to drag the item onto an adjacent Home screen.
- 3 Lift finger to place the item on the Home screen.

Removing an App or Widget from the Home Screen

Procedure:

- 1 Go to the desired Home screen.
- 2 Touch and hold the application shortcut or widget icon until it floats on the screen.
- 3 Drag the icon to  **Remove** on the top of the screen and then release.

Folders

Use **Folders** to organize similar applications together. Tap the folder to open and display items in the folder.

Creating Folders

Procedure:

- 1 Go to the desired Home screen.
- 2 Place at least two application shortcuts on the Home screen.
- 3 Touch and hold a shortcut until it floats on the screen.
- 4 Move the icon over another icon. A blue circle appears around the icons.

Figure 20: Stacked Shortcut Icons



- 5 Lift finger to stack the icons. The shortcut icons appear over a black circle.

Figure 21: Unnamed Folder



Naming Folders

Procedure:

- 1 Touch the folder.

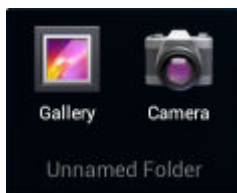
Figure 22: Open Folder

- 2 Touch the title area and enter a folder name using the keyboard.
- 3 Touch **Done**.
- 4 Touch anywhere on the Home screen to close the folder. The folder name appears under the folder.

Figure 23: Renamed Folder

Removing a Folder From the Home Screen

Procedure:

- 1 Touch and hold the folder icon until it floats on the screen.
- 2 Drag the icon to  in the top left corner of the screen and then release.

Home Screen Wallpaper



Note: Use of Live Wallpaper may reduce battery life.

Change the Home Screen Wallpaper

Procedure:

- 1 Touch and hold on the Home screen until the **Choose Wallpaper from** menu appears.
- 2 Touch **Gallery**, **Live wallpapers** or **Wallpapers**.
 - **Gallery** - Select to use an image stored on the device.
 - **Live wallpapers** - Select to use an animated wallpaper image.
 - **Wallpapers** - Select to use a wallpaper image.
- 3 Touch **Save** or **Set wallpaper**.

Moving Items on the Home Screen

Procedure:

- 1 Touch and hold the item until it enlarges.
- 2 Drag the item to a new location. Pause at the edge of the screen to drag the item onto an adjacent Home screen.
- 3 Lift finger to place item.

Removing Items from the Home Screen

Procedure:



- 1 Touch and hold the item until it enlarges.
- 2 Drag the item over  in the top left corner of the screen and then release..

Using the Touchscreen

Use the multi-tap sensitive screen to operate the device.

- **Tap** - Tap to:
 - select items on the screen
 - type letters and symbols using the on-screen keyboard
 - press on-screen buttons.
- **Tap and Hold** - Tap and hold:
 - an item on the Home screen to move it to a new location or to the trash.
 - an item in Apps to create a shortcut on the Home screen.
 - the Home screen to open a menu for customizing the Home screen.
 - an empty area on the Home screen until the menu appears.
- **Drag** - Tap and hold an item for a moment and then move finger on the screen until reaching the new position.
- **Swipe** - Move finger up and down or left and right on the screen to:
 - unlock the screen
 - view additional Home screens
 - view additional application icons in the Launcher window
 - view more information on an application's screen.
- **Double-tap** - Tap twice on a web page, map, or other screen to zoom in and out.
- **Pinch** - In some applications, zoom in and out by placing two fingers on the screen and pinching them together (to zoom out) or spreading them apart (to zoom in).

Using the On-screen Keyboard



Use the on-screen keyboard to enter text in a text field. To configure the keyboard settings, touch  (comma) >  and then select **Android keyboard settings**.

Editing Text

Edit entered text and use menu commands to cut, copy, and paste text within or across applications. Some applications do not support editing some or all of the text they display; others may offer their own way to select text.

Entering Numbers, Symbols and Special Characters

To enter numbers and symbols:

- Touch and hold one of the top-row keys until a menu appears then select a number. Keys with alternate characters display an ellipsis (...) below the character.
- Touch and hold the Shift key with one finger, touch one or more capital letters or symbols to enter them, and then lift both fingers to return to the lowercase keyboard.
- Touch  to switch to the numbers and symbols keyboard.
- Touch the  key on the numbers and symbols keyboard to view additional symbols.

To enter special characters, touch and hold a number or symbol key to open a menu of additional symbols.

- A larger version of the key displays briefly over the keyboard.
- Keys with alternate characters display an ellipsis (...) below the character.

Entering Text

Enter text using the on-screen keyboard:





Note:

Some apps open the keyboard automatically. In others, open it by touching where to type.

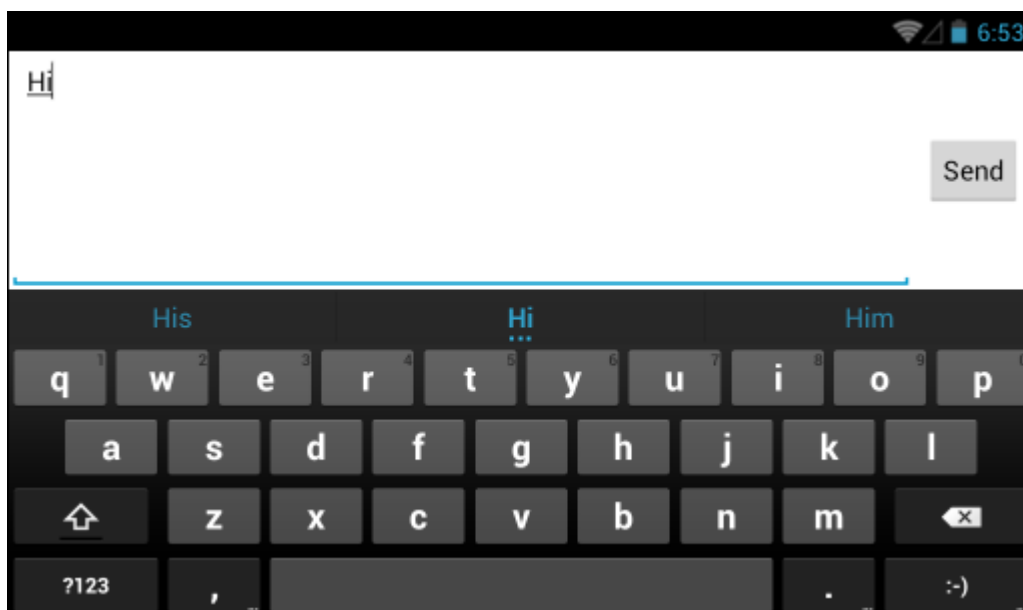
Figure 24: On-screen Keyboard



Procedure:

- 1 Touch a text field. The on-screen keyboard appears.
- 2 Touch keys on the keyboard to enter text.
The entered text appears in the text field and in the suggestion strip. When the keyboard has a suggestion, the word is underlined in the text field and the suggestions appear in blue. The boldfaced suggestion at the center of the strip is the keyboard's best suggestion. Drag the strip to the left to view additional suggestions.
- 3 Press space or a punctuation mark to enter the boldfaced suggested word.
- 4 Touch  to erase characters to the left of the cursor.
- 5 Touch  to close the keyboard.

Applications

The **APPS** screen displays icons for all installed applications. [Table 6: ET1 Default Applications on page 40](#) lists the default applications on the ET1. Refer to the *ET1 Enterprise Tablet Integrator Guide* for information on installing and uninstalling application.

Table 6: ET1 Default Applications











Icon	Description
	Browser - Use to access the Internet or intranet.
	Calculator - Provides the basic and scientific arithmetic functions.
	Calendar - Use to manage events and appointments.
	Camera - Take photos or record videos. See Photos and Videos on page 67 for more information.
	Clock - Use to schedule alarms for appointments or as a wake-up.
	DataWedge - Enables data capture using the camera or optional scanner.
	Downloads - lists all downloads files.
	DWDemo - Provides a way to demonstrate the data capture features using the Camera, Scanning Module or Magnetic Stripe Reader.
	Email - Use to send and receive email.
	File Browser - Organize and manage files on the ET1. See File Browser on page 46 for more information.
	Gallery - Use to view photos stored on the microSD card. See Photos and Videos on page 67 for more information.

Table continued...















Icon	Description
	GPS Status 2 - Use to configure location services.
	Messaging - Use to send and receive SMS messages on ET1N2 only.
	MSP Agent - Enables management of the ET1 from an MSP server. Requires the purchase of an appropriate MSP client license per device to suit the level of management functionality required.
	Music - Play music stored on the microSD card.
	Contacts - Use to manage contact information.
	Rapid Deployment - Allows the ET1 to stage a device for initial use by initiating the deployment of settings, firmware and software. Requires the purchase of an MSP client license per device.
	RIL Log - Use to capture debugging information. (ET1N2 only).
	Search - Use the search engine to search the Internet and the ET1.
	Settings - Use to configure the ET1. For more information, refer to the <i>ET1 Enterprise Tablet Integrator Guide</i> .
	Sound Recorder - Use to record audio.
	TechDocs - Displays the On-device User Guide.
	AppLock Administrator - Use to configure the Application Lock feature. This icon appears after the optional application is installed.
	MultiUser Administrator - Use to configure the MultiUser feature. This icon appears after the optional application is installed.

Table continued...

Icon	Description
	Secure Storage Administrator - Use to configure the Secure Storage feature. This icon appears after the optional application is installed.
	DWDemo - Provides a way to demonstrate the data capture features using the Camera, Scanning Module or Magnetic Stripe Reader.

Switching Between Recent Applications

Procedure:

- 1 Touch and hold . A screen appears with recently used applications.

Figure 25: Recently Used Applications

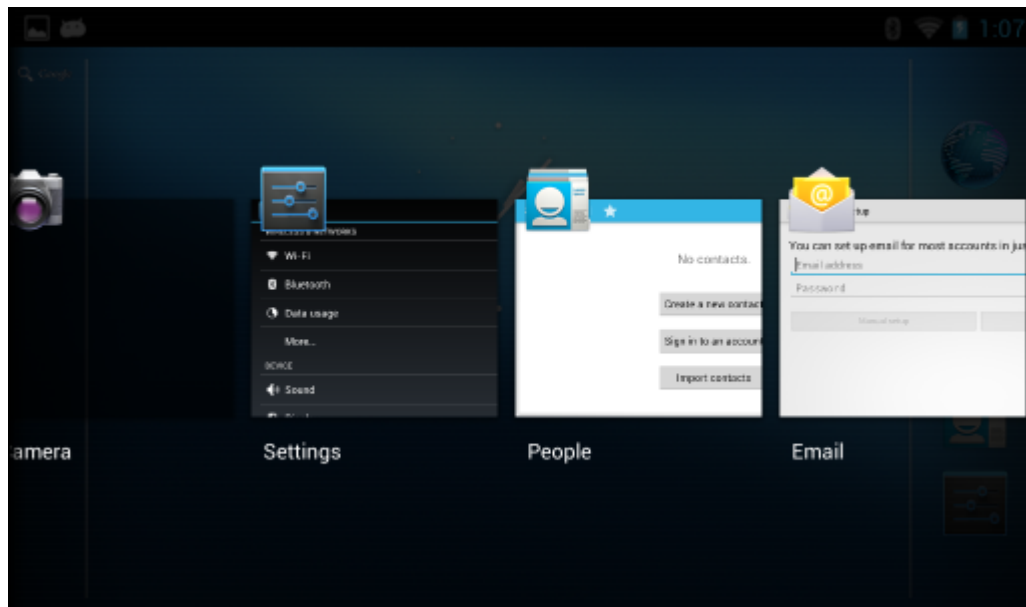

- 2 Touch an application to open it or press  to return to the current screen.
- 3 Swipe an application up or down to remove from the list.



Un-Locking the Screen

Use the Lock screen to protect access to data on the ET1. Some email accounts require locking the screen. Refer to the *ET1 Enterprise Tablet Integrator Guide* for information on setting up the locking feature. The Locking feature functions differently in Single User mode or Multiple User mode.

Single User Mode

When locked, a pattern, PIN or password is required to unlock the device. Press the Power button to lock the screen. The device also locks after a pre-defined time-out.

Press and release the Power button to wake the device.

The Lock screen displays. Touch and slide  up until it touches . If the Pattern screen unlock feature is enabled, the Pattern screen appears instead of the Lock screen.

If the PIN or Password screen unlock feature is enabled, enter the PIN or password after unlocking the screen.

Figure 26: Lock Screen

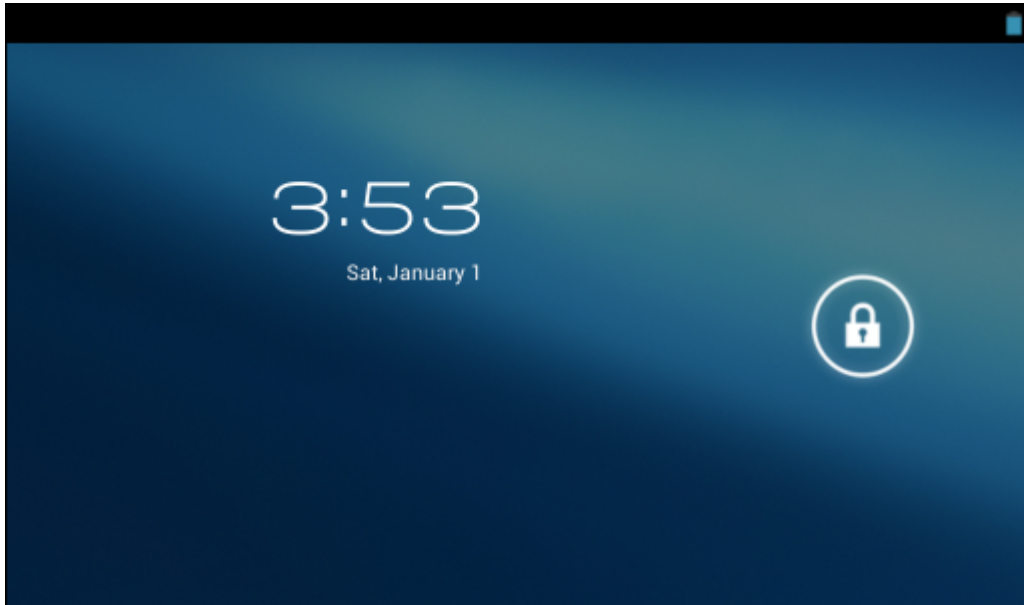

Figure 27: PIN Screen

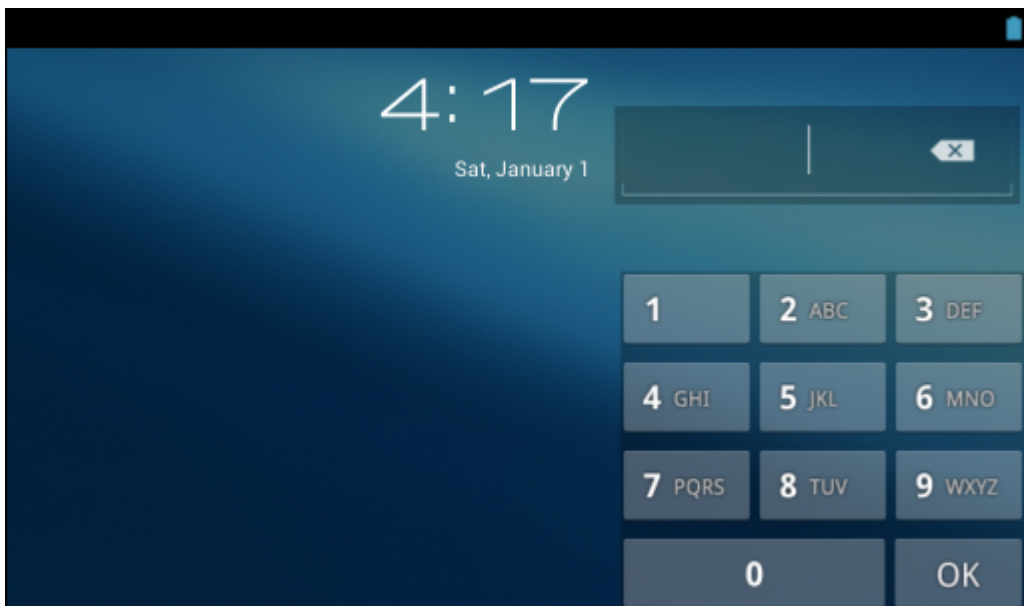
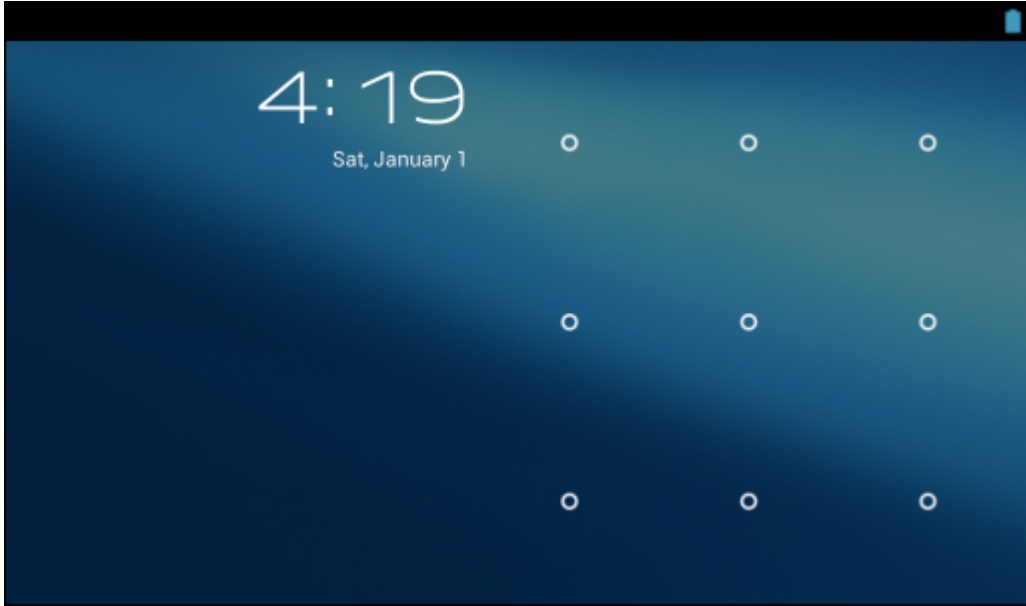
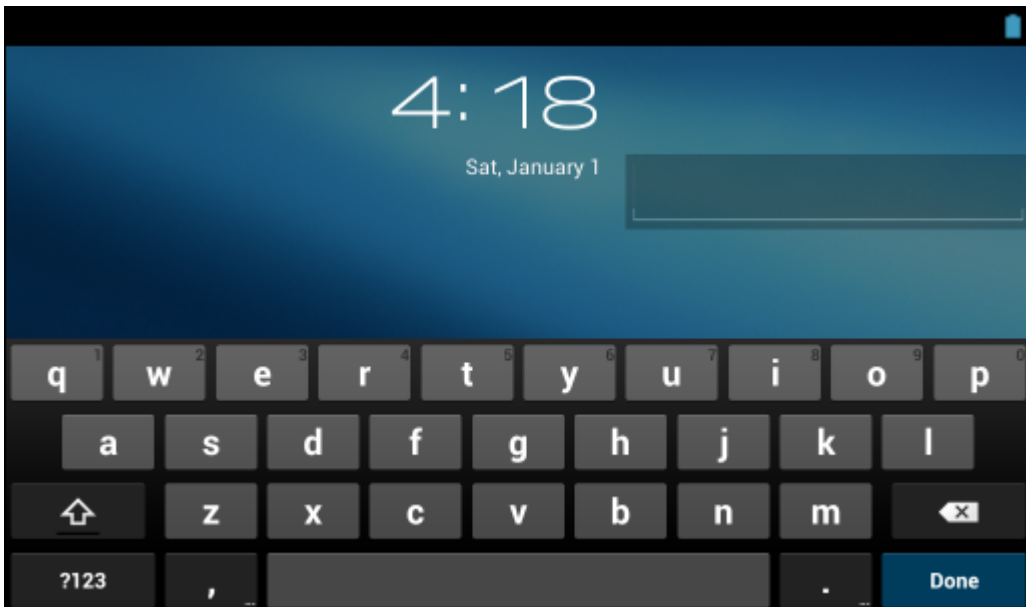

Figure 28: Pattern Screen**Figure 29: Password Screen**

MultiUser Mode

With MultiUser login, multiple users can log on to the device with each user having access to various applications and features. When enabled, the Login screen appears after powering on, resetting or after the device wakes from suspend mode.

Multiuser Login

Procedure:

- 1 In the **Login** text field, enter the username.

Figure 30: Multiple user Log In Screen

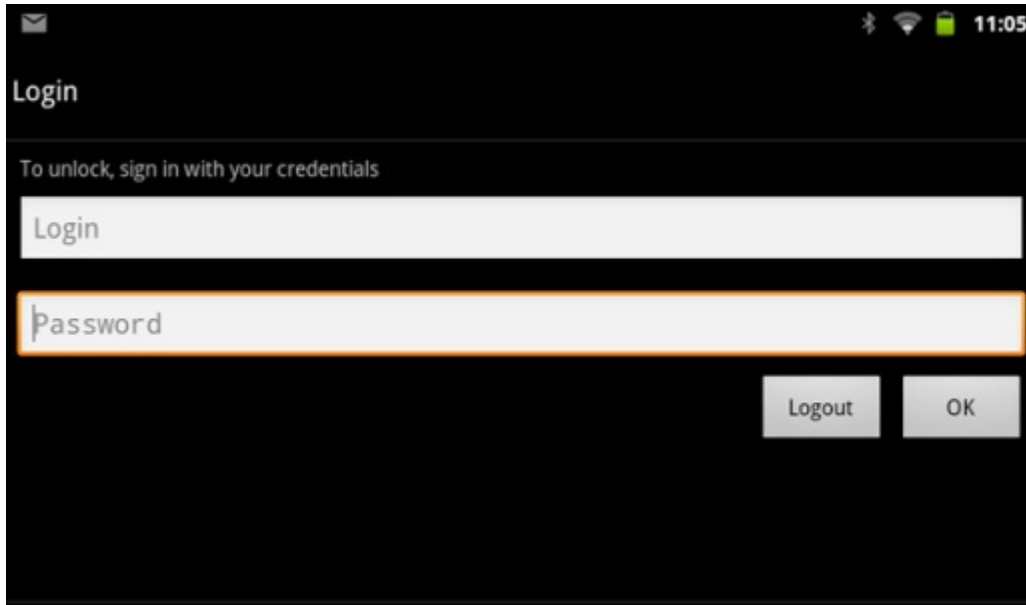

- 2 In the **Password** text field, enter the password.
- 3 Touch **OK**. After a resume from suspend, the user must enter the password.

Multiuser Logout

Procedure:

- 1 Drag the Status Bar down from the top of the screen.
- 2 Touch **MultiUser is active**.
- 3 Touch **Logout**.
- 4 The **Login** screen appears.

Resetting the Device

There are two reset functions, soft reset and hard reset.

Performing a Soft Reset

Perform a soft reset if applications stop responding.

Procedure:

- 1 Press and hold the Power button until the menu appears.
- 2 Touch **Reset**.
- 3 The device shuts down and then reboots.
- 4 The device reboots.

Performing a Hard Reset



Caution: Performing a hard reset with a SIM card installed in the ET1N2 may cause damage or data corruption to the SIM card.

Perform a hard reset if the ET1 stops responding. To perform a hard reset:

Procedure:

- 1 Simultaneously press the Power, Left Scan/Action and Right Scan/Action buttons.
- 2 The ET1 shuts down and then reboots.

Wake-up Settings



The wake-up conditions define what actions wake up the ET1 after it has gone into suspend mode. The ET1 can go into suspend mode by either pressing the Power button or automatically by a time-out settings. [Table 7: Wake-up Default Settings on page 46](#) list the default wake up conditions.

Table 7: Wake-up Default Settings

Condition for Wake-up	Power Button	Automatic Time-out
AC power is applied.	No	Yes
ET1 is inserted into a cradle.	Yes	Yes
ET1 is removed from a cradle.	No	No
ET1 is connected to a USB device.	No	Yes
ET1 is disconnected from a USB device.	No	Yes
Scan/Action button is pressed.	Yes	Yes
The screen is touched.	No	No
Bluetooth communication	Yes	Yes

Waking the ET1

If the ET1 is not used for a while, the screen dims and then darkens to conserve the battery.

The Lock screen displays. Touch and slide  up until it touch . If the Pattern screen unlock feature is enabled, the Pattern screen appears instead of the Lock screen. See [Un-Locking the Screen on page 42](#) for more information.

File Browser

Use the **File Browser** application to view and manage files on the ET1.

To open **File Browser**, touch  > .

Figure 31: File Browser Screen

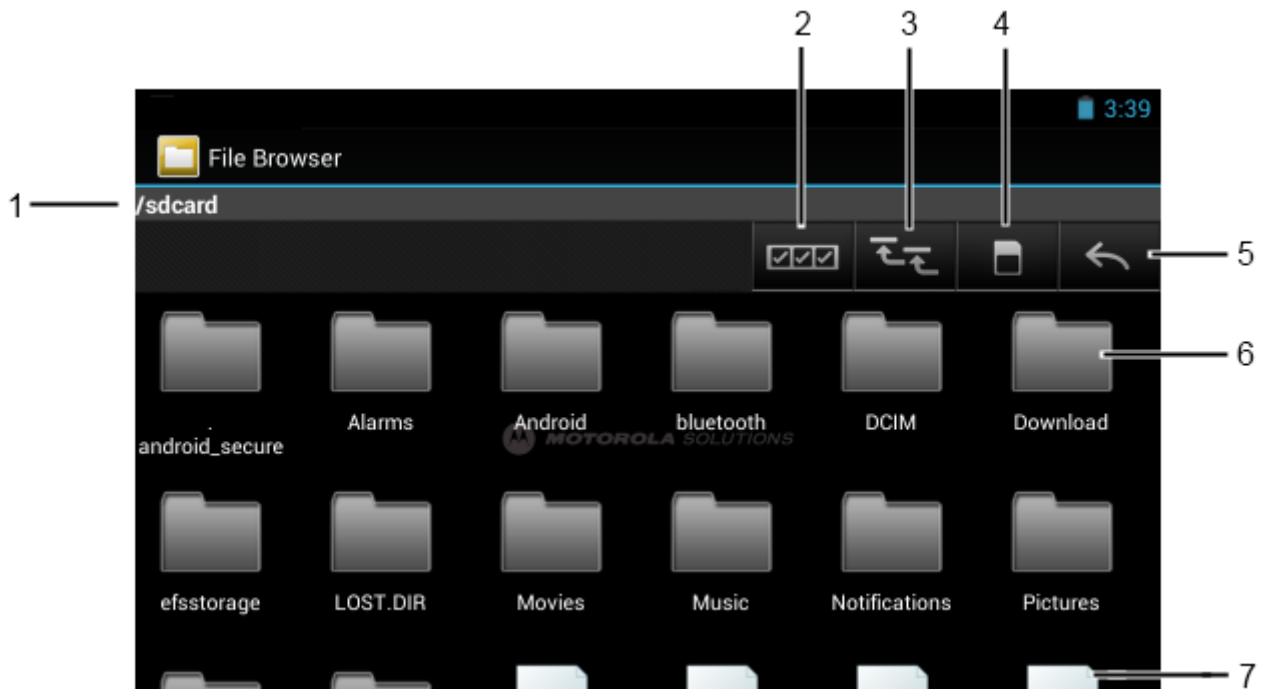

The address bar (1) indicates the current folder path. Touch the current folder path to manually enter a path and folder name.

Use  (2) to select multiple files/folder.

Use  (3) to view to the ET1 internal storage root folder.





Use  (3) to view the microSD card root folder.

Use  (4) to view the previous folder or to exit the application.

Touch and hold an item to perform an operation on that item. Select one of the options from the menu:

- **Information** - View detailed information about the file or folder.
- **Move** - Move the file or folder to a new location.
- **Copy** - Copy the select file.
- **Delete** - Delete the selected file.
- **Rename** - Rename the select file.
- **Open as** - Open the selected file as a specific file type.

Touch  to open additional functionality:

- Touch  > **New Folder** to create a new folder in the current folder.
- Touch  > **Search** to search for a file or folder.
- Touch  > **Sort** to sort the list by name, by type, by size or by date.
- Touch  > **Refresh** to re-display the contents of the current folder.
- Touch  > **List View** to change the folder view from tile to list format.

- Touch  > **Change Size** to change the size of the icons: Large, Normal or Small.

Messaging



Note:

Messaging is only available on the ET1N2 configuration.

Use **Messaging** to exchange text messages (SMS) with other mobile devices.

Opening Messaging

To open the Messaging application touch  > . The **Messaging** window opens.

- Touch **NEW MESSAGE** to start a new text message.
- Touch an existing message thread to open it.

Sending a Text Message

Procedure:

- 1 On the **Messaging** screen, touch **NEW MESSAGE**.
- 2 In the **To** field, enter a mobile phone number or contact name.
- 3 Touch the **Type message** text box to start entering a message.

A text message is limited to 160 character.

If the user goes over that limit, multiple text messages are sent. If the user presses  while composing a message, it's saved as a draft in the **Messaging** window. Touch the message to resume composing it.

- 4 Touch .

The Message window opens, with the message after the user's name. Responses appear in the window. As the user views and sends additional messages, a message thread is created

Responding to a Message

When a new message is received a notification appears and  appears in the Status bar.

Pull down the Notification Shade and touch the message notification.

The **Message** window appears.

Touch and hold a message until the **Message options** menu appears with number of options for working with the message and its sender's information.

Forwarding a Message

Procedure:

- 1 Touch and hold a message until the **Message options** menu appears.
- 2 Touch **Forward**.
- 3 Enter a recipient for the message and edit the content.

- 4 Touch .

Locking a Message

Lock a message so it can not be deleted if the storage limits is reached. If the user tries to delete a thread that contains a locked message, the user is asked to confirm deleting it.

Procedure:

- 1 Touch and hold a message in a Message window until the **Message options** menu appears.
- 2 Touch **Lock**. A lock icon appears to the right of the message.
To unlock a message, Touch and hold a message until the **Message options** menu appears. Touch **Unlock**.

Viewing Message Details

Procedure:



- 1 Touch and hold a message until the **Message options** menu appears.
- 2 Touch **View details**. The **Message details** dialog box appears.
- 3 Touch the screen anywhere outside the dialog box to close.

Deleting a Message Thread

Procedure:

- 1 Touch and hold the message thread until the a menu appears.
- 2 Touch **Delete thread**.

Messaging Settings

To change Messaging settings touch  >  >  > **Settings**.

- **STORAGE**
 - **Delete old messages** - Check to delete older messages in a thread when the text message limit is reached. Uncheck to keep all messages.
 - **Text message limit** - Touch to set the number of messages to save per thread of text messages. When the limit is reached, older messages are deleted if **Delete old messages** is checked.
- **TEXT (SMS) MESSAGES**
 - **Manage SIM card messages** - View text messages stored on a SIM card.
- **NOTIFICATIONS**
 - **Notifications** - Check to receive a notification whenever the ET1 receives a new message.
 - **Choose ringtone** - Opens a dialog box to select the ringtone to sound when the ET1 receives a new message notifications.
 - **Vibrate** - Opens a dialog box to set the ET1 to vibrate whenever it receives a new message notification. Options: **Always**, **Only when silent** or **Never** (default).

Chapter

3

Data Capture

The ET1 offers the following data capture options:

- Scanning Module
- Scanning/MSR Module
- integrated digital camera
- optional CS3070 Bluetooth laser scanner.



Note: DataWedge is installed and enabled on the ET1 by default.

Scanning Modules

The ET1 with an integrated Scan Module has the following features:

- Omnidirectional reading of a variety of bar code symbologies, including the most popular linear, postal, PDF417, and 2D matrix code types.
- Advanced intuitive laser aiming cross-hair for easy point-and-shoot operation.

The module uses digital camera technology to take a digital picture of a bar code, stores the resulting image in its memory, and executes state-of-the-art software decoding algorithms to extract the data from the image.

Operational Modes

The device with an integrated imager supports two modes of operation, listed below. Activate each mode by pressing a scan button.

- **Decode Mode:** In this mode, the device attempts to locate and decode enabled bar codes within its field of view. The imager remains in this mode as long as the user holds the scan button, or until it decodes a bar code.



Note: To enable Pick List Mode, configure in DataWedge.

- **Pick List Mode:** This mode allows the user to selectively decode a bar code when more than one bar code is in the device's field of view. To accomplish this, move the aiming crosshair over the required bar code to decode only this bar code. This feature is ideal for pick lists containing multiple bar codes and manufacturing or transport labels containing more than one bar code type (either 1D or 2D).

Digital Camera

The device with an integrated camera based bar code scanning solution has the following features:

- Omnidirectional reading of a variety of bar code symbologies, including the most popular linear, postal, QR, PDF417, and 2D matrix code types.
- Cross-hair reticle for easy point-and-shoot operation.

- Picklist mode to decode a particular bar code from many in the field of view.

The solution uses the advanced camera technology to take a digital picture of a bar code, and executes state-of-the-art software decoding algorithms to extract the data from the image.

Laser Scanning

The optional CS3070 scanner has the following features:

- Reading of a variety of bar code symbologies, including the most popular linear, postal, and 1-D code types.
- Intuitive aiming for easy point-and-shoot operation.

Scanning Considerations

Typically, scanning is a simple matter of aim, scan, and decode where a few quick trial efforts master it. However, consider the following to optimize scanning performance:

- Range
 - Any scanning device decodes well over a particular working range — minimum and maximum distances from the bar code. This range varies according to bar code density and scanning device optics.
 - Scanning within range brings quick and constant decodes; scanning too close or too far away prevents decodes. Move the scanner closer and farther away to find the right working range for the bar codes being scanned.
- Angle
 - Scan angle is important for promoting quick decodes. When laser beams reflect directly back into the scanner from the bar code, this specular reflection can “blind” the scanner.
 - To avoid this, scan the bar code so that the beam does not bounce directly back. But do not scan at too sharp an angle; the scanner needs to collect scattered reflections from the scan to make a successful decode. Practice quickly shows what tolerances to work within.
- Hold the device farther away for larger symbols.
- Move the device closer for symbols with bars that are close together.



Note: Scanning procedures depend on the application and device configuration. An application may use different scanning procedures from those described.

Bar Code Capture with Scanning or Scanning/MSR Module

Procedure:

- 1 Ensure that an application is open on the ET1 and a text field is in focus (text cursor in text field).
- 2 Point the top of the ET1 at a bar code.

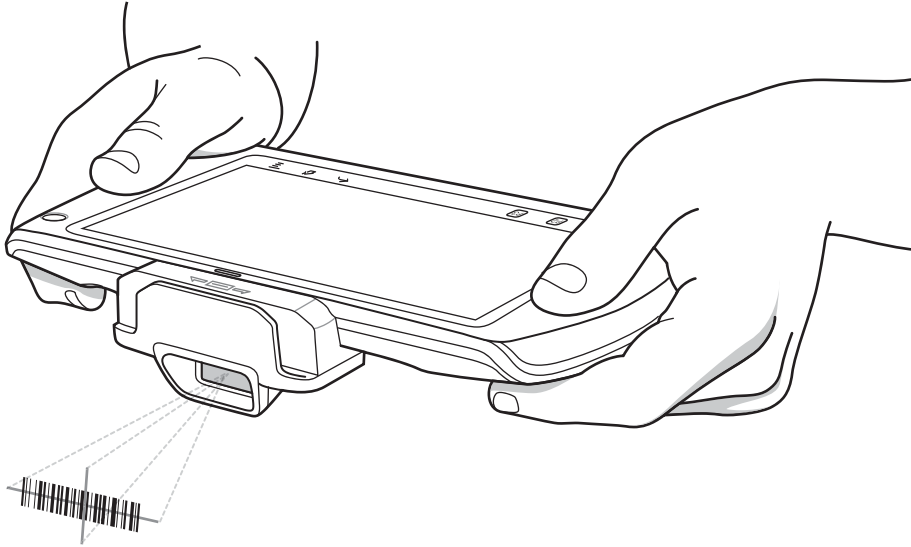
Figure 32: Bar Code Scanning

- 3 Press and hold either Scan/Action button.

The red laser aiming pattern turns on to assist in aiming. Ensure the bar code is within the area formed by the cross-hairs in the aiming pattern. The aiming dot is used for increased visibility in bright lighting conditions.

The Scan/Decode LED lights red to indicate that scanning is in process, then lights green, a beep sounds and the ET1 vibrates, by default, to indicate the bar code was decoded successfully. Note that when the ET1 is in Pick List Mode, the ET1 does not decode the bar code until the center of the crosshair touches the bar code.

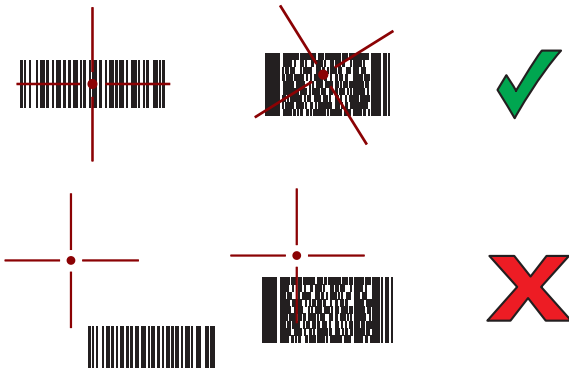
Figure 33: Aiming Pattern**Figure 34: Pick List Mode with Multiple Bar Codes in Aiming Pattern**

- 4 Release the scan button.
- 5 The captured data appears in the text field.

Bar Code Capture with Integrated Camera

Procedure:

- 1 Ensure that an application is open on the ET1 and a text field is in focus (text cursor in a text field).
- 2 Aim the rear-facing camera at a bar code.
- 3 Press and hold either Scan/Action button. By default, a preview window appears. The Decode light emitting diode (LED) lights red to indicate that data capture is in process.

Figure 35: Sample Scan Application with Preview Window

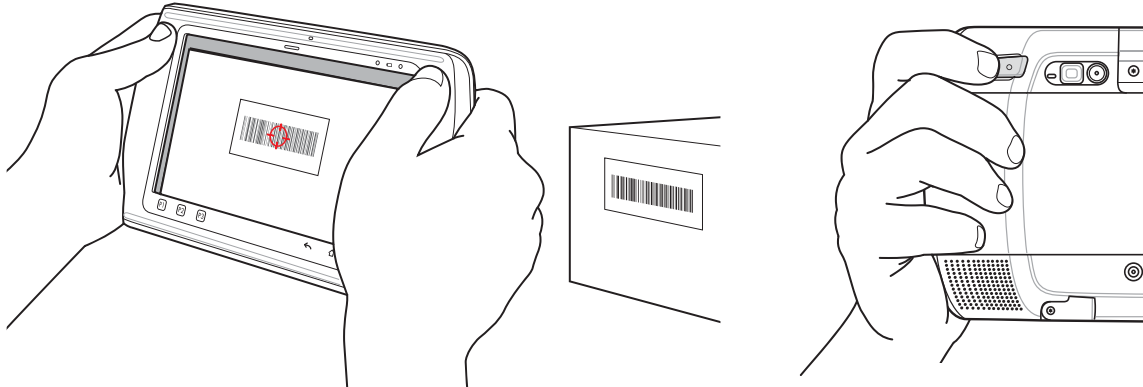

- 4 Move the ET1 until the bar code is centered.
- 5 The Decode LED lights green, a beep sounds and the ET1 vibrates, by default, to indicate the bar code was decoded successfully.
- 6 The captured data appears in the text field.

Bar Code Capture with CS3070 Bluetooth Scanner

The CS3070 Bluetooth scanner captures bar code data, and transmits it to the ET1 via Bluetooth. The scanner supports Bluetooth human interface device (HID) connection to the ET1 where the scanner emulates a keyboard, as well as Serial Port Profile (SPP) connection where the scanner behaves as if there is a serial connection. See the *ET1 Enterprise Tablet Integrator Guide* for setup and configuration information.

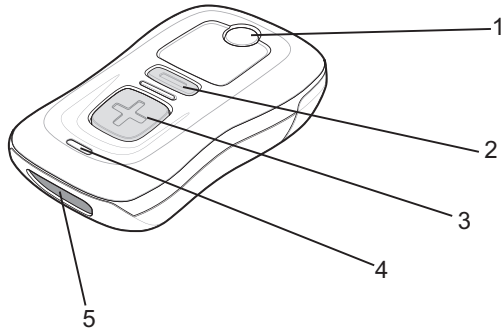
Figure 36: CS3070 Bluetooth Scanner

- 1 Bluetooth Button/LED
- 2 Delete Button
- 3 Scan Button
- 4 LED
- 5 Exit Window

Procedure:

- 1 Ensure that an application is open on the ET1 and a text field is in focus (text cursor in a text field).
- 2 Aim the scanner at the bar code.
- 3 Press the scan (+) button.

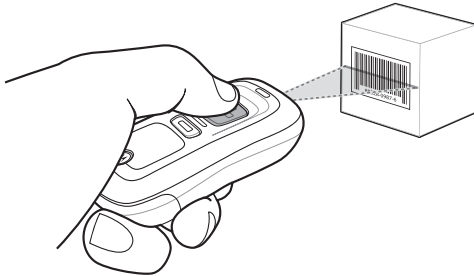
Figure 37: CS3070 Scanning

- 4 Ensure the scan line crosses every bar and space of the symbol.

Figure 38: Linear Scanner Aiming Pattern

- 5 The scanner beeps and the LED turns green to indicate a successful decode.
- 6 The captured data appears in the text field.

Reading Magnetic Stripe Cards with Scanning/MSR Module

Use the Scanning/MSR Module to read magnetic stripe cards.

Procedure:

- 1 Ensure that **MSR input** is enabled in DataWedge and the cursor is in a text field.
- 2 Align the magnetic stripe on the card toward the display and swipe the card in either direction.

Figure 39: Swiping a Magnetic Stripe Card

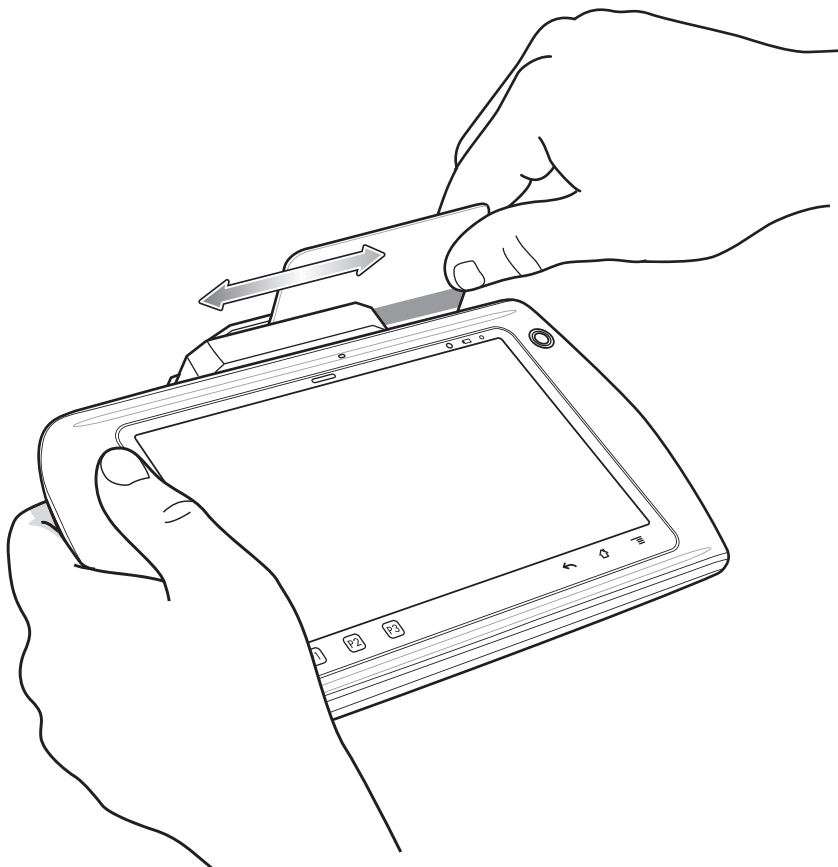

- 3 The captured data appears in the text field.

DataWedge





DataWedge is a utility that adds advanced bar code scanning capability to any application without writing code. It runs in the background and handles the interface to built-in bar code scanners. The captured bar code data is converted to keystrokes and sent to the target application as if it was typed on the keypad.

To configure DataWedge refer to the *ETI Integrator Guide*.

Enabling DataWedge

To enable DataWedge:





Procedure:

- 1 Touch .
- 2 Touch . The **DataWedge Profiles** window appears.
- 3 Touch .
- 4 Touch **Settings**.
- 5 Touch the **DataWedge enabled** checkbox. A blue checkmark appears in the checkbox indicating that DataWedge is enabled.
- 6 Touch .

Disabling DataWedge

To disable DataWedge:

Procedure:

- 1 Touch .
- 2 Touch . The **DataWedge Profiles** window appears.
- 3 Touch .
- 4 Touch **Settings**.
- 5 Touch the **DataWedge enabled** checkbox. The blue checkmark disappears from the checkbox indicating that DataWedge is disabled.
- 6 Touch .

DataWedge Configuration

To configure DataWedge see the *ETI Enterprise Tablet Integrator Guide*.

Chapter

4

WLAN

Wireless local area networks (WLANs) allow the ET1 to communicate wirelessly inside a building. Before using the ET1 on a WLAN, the facility must be set up with the required hardware to run the WLAN (sometimes known as infrastructure). The infrastructure and the ET1 must both be properly configured to enable this communication.

Refer to the documentation provided with the infrastructure (access points (APs), access ports, switches or Radius servers) for instructions on how to set up the infrastructure.

Once the infrastructure is set up to enforce the chosen WLAN security scheme, use the **Wi-Fi** settings configure the ET1 to match the security scheme.







Note: Turn off Wi-Fi when not using it, to extend the life of the battery.

The Status Bar displays icons that indicate Wi-Fi network availability and Wi-Fi status. See [Status Bar on page 32](#) more information.

Connecting to a Wi-Fi Network

Procedure:

- 1 Touch .
- 2 Touch  **Wi-Fi**.
- 3 Slide the Wi-Fi switch to the **On** position. The ET1 searches for WLANs in the area and displays them in the list. Open networks are indicated with  and secure networks are indicated with .
- 4 Scroll through the list and touch the desired WLAN network.
- 5 For open networks, the ET1 automatically connects to the network.
For secure networks, enter the required password or other credentials then touch **Connect**. See the system administrator for more information.
The ET1 obtains a network address and other required information from the network using the dynamic host configuration protocol (DHCP) protocol. To configure the ET1 with a fixed internet protocol (IP) address, see the *ET1 Enterprise Tablet Integrator Guide*.
- 6 When the ET1 connects to the network, the network name appears at the top of the list and **Connected** appears below the network name.

Chapter 5

Bluetooth

Bluetooth-equipped devices can communicate without wires, using frequency-hopping spread spectrum (FHSS) radio frequency (RF) to transmit and receive data in the 2.4 GHz Industry Scientific and Medical (ISM) band (802.15.1). Bluetooth wireless technology is specifically designed for short-range (10 meters (32.8 feet)) communication and low power consumption.

Devices with Bluetooth capabilities can exchange information (e.g., files, appointments, and tasks) with other Bluetooth enabled devices such as printers, access points, and other mobile devices.

Adaptive Frequency Hopping

Adaptive Frequency Hopping (AFH) is a method of avoiding fixed frequency interferers, and can be used with Bluetooth voice. All devices in the piconet (Bluetooth network) must be AFH-capable in order for AFH to work. There is no AFH when connecting and discovering devices. Avoid making Bluetooth connections and discoveries during critical 802.11b communications. AFH for Bluetooth consists of four main sections:

- Channel Classification - A method of detecting an interference on a channel-by-channel basis, or pre-defined channel mask.
- Link Management - Coordinates and distributes the AFH information to the rest of the Bluetooth network.
- Hop Sequence Modification - Avoids interference by selectively reducing the number of hopping channels.
- Channel Maintenance - A method for periodically re-evaluating the channels.

When AFH is enabled, the Bluetooth radio “hops around” (instead of through) the 802.11b high-rate channels. AFH coexistence allows Enterprise devices to operate in any infrastructure.

The Bluetooth radio in this device operates as a Class 2 device power class. The maximum output power is 2.5 mW and the expected range is 10 meters (32.8 ft.). A definition of ranges based on power class is difficult to obtain due to power and device differences, and whether one measures open space or closed office space.



Note: It is not recommended to perform Bluetooth wireless technology inquiry when high rate 802.11b operation is required.

Security

The current Bluetooth specification defines security at the link level. Application-level security is not specified. This allows application developers to define security mechanisms tailored to their specific need. Link-level security occurs between devices, not users, while application-level security can be implemented on a per-user basis. The Bluetooth specification defines security algorithms and procedures required to authenticate devices, and if needed, encrypt the data flowing on the link between the devices. Device authentication is a mandatory feature of Bluetooth while link encryption is optional.

Pairing of Bluetooth devices is accomplished by creating an initialization key used to authenticate the devices and create a link key for them. Entering a common personal identification number (PIN) in the devices being paired generates the initialization key. The PIN is never sent over the air. By default, the Bluetooth stack responds with no

key when a key is requested (it is up to user to respond to the key request event). Authentication of Bluetooth devices is based-upon a challenge-response transaction. Bluetooth allows for a PIN or passkey used to create other 128-bit keys used for security and encryption. The encryption key is derived from the link key used to authenticate the pairing devices. Also worthy of note is the limited range and fast frequency hopping of the Bluetooth radios that makes long-distance eavesdropping difficult.

Recommendations are:

- Perform pairing in a secure environment
- Keep PIN codes private and do not store the PIN codes in the device
- Implement application-level security.

Bluetooth Profiles

The ET1 supports the following Bluetooth services:

- Generic Access Profile (GAP) - Must support both Initiator and Acceptor roles.
- Service Discovery Protocol (SDP) - Supports both Local Device and Remote Device.
- Serial Port Profile (SPP) - Supports both Device A and Device B roles.
- Human Interface Device (HID) Profile - Supports Host role.
- Dial-up Networking (DUN) Profile - Supports connecting a computer to the ET1 to access the internet.

Bluetooth Power States

The Bluetooth radio is off by default.

- **Suspend** — When there is no active Bluetooth connections, the Bluetooth radio turns off.



Note: If there is an active Bluetooth connection between the ET1 and another Bluetooth device and there is no data activity, the ET1 will time out. However, if the user presses the Power button on the ET1, the ET1 will suspend and upon receiving data from a remote Bluetooth device, the ET1 will wake from suspend mode. For example, Bluetooth scanner sending data to the ET1.

- **Resume** — When the ET1 resumes, Bluetooth turns on if it was on prior to suspend.
- **Airplane Mode** — When the ET1 is placed in Airplane Mode, the Bluetooth radio turns off. When Airplane Mode is disabled, the Bluetooth radio returns to the prior state.

Bluetooth Radio Power – Android



Turn off the Bluetooth radio to save power or if entering an area with radio restrictions (e.g., an airplane). When the radio is off, other Bluetooth devices cannot see or connect to the device. Turn on the Bluetooth radio to exchange information with other Bluetooth devices (within range). Communicate only with Bluetooth radios in close proximity.



Note: To achieve the best battery life turn off radios when not in use.

Enabling Bluetooth



Procedure:

- 1 Touch .
- 2 Slide the Bluetooth switch to the **ON** position. The Bluetooth icon  also appears in the Status bar.

- 3 Touch .

Disabling Bluetooth

Procedure:

- 1 Touch .
- 2 Slide the Bluetooth switch to the **OFF** position.
- 3 Touch .

Discovering Bluetooth Devices

The ET1 can receive information from discovered devices without pairing. However, once paired, the ET1 and a paired device exchange information automatically when the Bluetooth radio is on. To find Bluetooth devices in the area:

Procedure:



- 1 Ensure that Bluetooth is enabled on both devices.
- 2 Ensure that the Bluetooth device to discover is in discoverable mode.
- 3 Ensure that the two devices are within 10 meters (32.8 ft.) of one another.
- 4 Touch .
- 5 Touch  **Bluetooth**.
- 6 Touch **SCAN FOR DEVICES**. The ET1 begins searching for discoverable Bluetooth devices in the area and displays them under **AVAILABLE DEVICES**.
- 7 Scroll through the list and select a device. The **Bluetooth pairing request** dialog box appears.

Figure 40: Bluetooth Pairing - Enter PIN

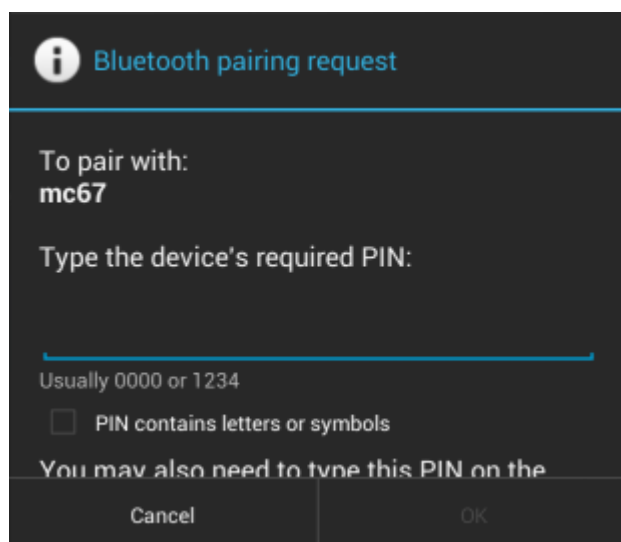
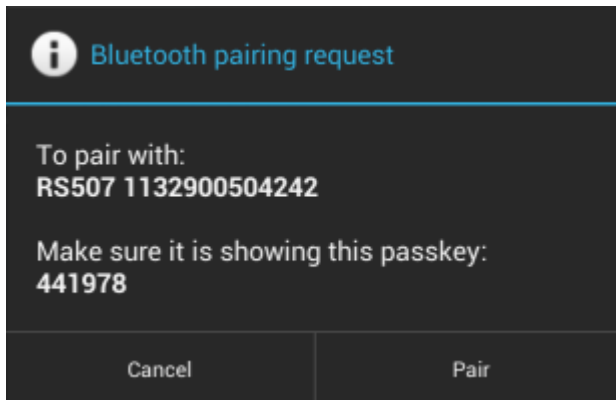

Figure 41: Bluetooth Pairing — Simple Pairing





- 8 Enter a PIN in the text box and touch **OK**.
- 9 Enter the same PIN on the other device. Touch **Pair**.
- 10 The Bluetooth device is added to the **PAIRED DEVICES** list and a trusted (“paired”) connection is established.

Changing the Bluetooth Name

By default, the ET1 has a generic Bluetooth name that is visible to other devices when connected.

To change the Bluetooth name:



Procedure:

- 1 Touch .
- 2 Touch  **Bluetooth**.
- 3 If Bluetooth is not on, slide the switch to the **ON** position.
- 4 Touch .
- 5 Touch **Rename device**. The **Rename device** dialog box appears.
- 6 Enter a name and touch **Done**.
- 7 Touch .

Connecting to a Bluetooth Device

Once paired, connect to a Bluetooth device:





Procedure:

- 1 Touch .
- 2 Touch  **Bluetooth**.
- 3 If Bluetooth is not on, slide the switch to the **ON** position.
- 4 In the **PAIRED DEVICES** list, touch and hold on an unconnected Bluetooth device until a menu appears.
- 5 Touch **Connect**. When connected, the device is displayed as connected in the list.

Selecting Profiles on the Bluetooth Device

Some Bluetooth devices have multiple profiles. To select a profile:



Procedure:

- 1 Touch .
- 2 Touch  **Bluetooth**.
- 3 If Bluetooth is not turned on, slide the blue switch to the **On** position.
- 4 In the **PAIRED DEVICES** list, touch  next to the device name.
- 5 Under **PROFILES**, check or uncheck a profile to allow the ET1 to use that profile.
- 6 Touch .

Unpairing a Bluetooth Device

To unpair a Bluetooth device and erase all pairing information:

Procedure:

- 1 Touch .
- 2 Touch **Bluetooth**.
- 3 In the **PAIRED DEVICES** list, touch  next to the device name.
- 4 Touch **Unpair**. The Bluetooth device is removed from the **PAIRED DEVICE** list.
- 5 Touch .

Chapter 6

Photos and Videos

This chapter provides information for taking photos and recording videos using the integrated digital cameras.



Note: Photos and videos are stored in Internal Storage.

Taking Photos







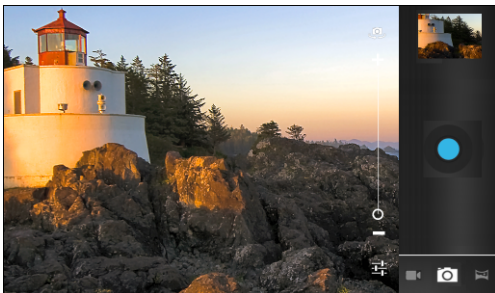

Note: Camera settings are described in [Camera Settings on page 69](#).

Procedure:

- 1 Touch .
- 2 Touch .



Figure 42: Camera Mode



- 3 If necessary, touch the options bar and touch .
- 4 Touch  to switch between the front or rear cameras.
- 5 Touch  to adjust exposure, flash, and other settings using the camera settings. See [Camera Settings on page 69](#) for more information.
- 6 Touch  and to adjust the zoom level.
- 7 Frame the subject on screen.
- 8 Touch .

The camera brings the image into focus. When the image is in focus, the focus indicators in each corner turn green, the camera takes a photo and a shutter sound plays.



Note: To disable the shutter sound, turn notification sounds off. Touch  >  **Sounds** > **Volumes** and slide the **Notifications** slider all the way to the left.

Alternately, touch  and hold to focus first, before taking a photo; then release to take a focused photo.

The photo appears momentarily then displays as a thumbnail in the upper right corner.

- 9 Touch the thumbnail to view the photo in **Gallery**. See [Viewing Photos and Videos on page 71](#) for more information.

Taking a Panoramic Photo

Panorama mode lets the user create a single wide image by panning slowly across a scene. To take a panoramic photo:

Procedure:





- 1 Touch .
- 2 Touch .
- 3 Touch the options bar and touch .

Figure 43: Panoramic Mode

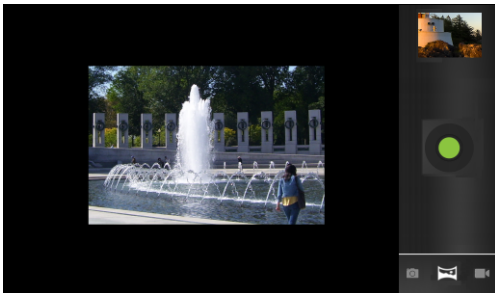

- 4 Frame one side of the scene to capture.
- 5 Touch  and slowly start panning across the area to capture. A small white square appears inside the button the shot is in progress.
If panning too quickly, the message **Too fast** appears.
- 6 Touch  to end the shot. The panorama appears immediately and a progress indicator displays while it saves the image.
- 7 Touch the thumbnail to view the photo in **Gallery**. See [Viewing Photos and Videos on page 71](#).

Recording Videos

Procedure:

- 1 Touch .
- 2 Touch .







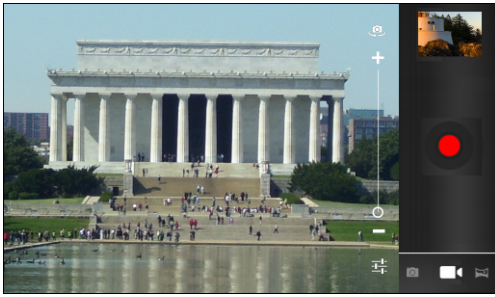

- 3 Touch the options bar and touch .

Figure 44: Video Mode





- 4 Touch  to switch between the front or rear cameras.
- 5 Touch  to adjust exposure, flash, and other settings using the video settings. See [Video Settings on page 70](#) for more information.
- 6 Touch  and to adjust the zoom level.
- 7 Point the camera and frame the scene.
- 8 Touch  to start recording.
- The ET1 starts recording the video. The video time remaining appears in the top left of the screen.
- 9 Touch  to end recording.
-  **Note:** Previously recorded video displays in the thumbnail at the top right.
- 10 Touch the thumbnail to access the **Gallery** application. See [Viewing Photos and Videos on page 71](#).













Camera Settings

When in Camera mode, Camera settings are displayed on screen. Touch  for the settings to change.

Rear-facing Camera Settings

Touch  to display the camera setting options.

-  **Camera Settings** - Touch to open a scrolling list of settings:
 - **Store location** - Include location information with each photo using the ET1 global positioning system (GPS). Options: **On** or **Off** (default).
 - **Focus Mode** - Set the focus mode of the camera. Options: **Macro**, **Infinity**, **Continuous**, or **Auto** (default).
 - **Capture mode** - Set the image capture mode. Options: **High Quality** (default) or **Zero Shutter Mode**.
 - **Picture size** - Touch to set the size (in pixels) of the photo. Options: **QVGA**, **VGA**, **1M Pixels**, **1.3M Pixels**, **2M pixels**, **3M pixels**, **5M pixels**, or **8M pixels** (default).
 - **ISO** - Set how sensitive the camera is to light. Options: **800**, **400**, **200**, **100**, or **Auto** (default).
 - **Picture quality** - Options: **Super fine** (default), **Fine** or **Normal**.
 - **Restore defaults** - Touch **Restore defaults** to restore all camera settings to the default values.

- **SCN Scene mode** - Touch to select a preset combination of camera settings designed for specific scenes. Options: **Auto** (default), **Portrait**, **Landscape**, **Night**, **Steady photo**, or **Sports**.
-  **Exposure** - Touch to adjust the exposure settings. Options: **+3**, **+2**, **+1**, **0** (default), **-1**, **-2**, or **-3**.
-  **White balance** - Touch to select how Camera adjusts colors in different kinds of light, to achieve the most natural-looking colors.
 -  **Auto** - Adjust the white balance automatically (default).
 -  **Incandescent** - Adjust the white balance for incandescent lighting.
 -  **Daylight** - Adjust the white balance for daylight.
 -  **Fluorescent** - Adjust the white balance for florescent lighting.
 -  **Cloudy** - Adjust the white balance for a cloudy environment.
-  **Flash mode** - Touch to set whether Rear-facing Camera relies on its light meter to decide whether a flash is necessary, or to turn it on or off for all shots.
 -  **Auto** - Camera adjusts flash automatically depending upon light meter.
 -  **On** - Enable flash upon taking a photo.
 -  **Off** - Disable flash (default).
 -  **Torch** - Turn flash on continuously.

Front-facing Camera Settings

Touch  to display the camera setting options.

-  **Camera Settings** - Touch to open a scrolling list of settings:
 - **Store location** - Include location information with each photo using the ET1 global positioning system (GPS). Options: **On** or **Off** (default).
 - **Picture size** - Touch to set the size (in pixels) of the photo. Options: **QVGA** or **VGA** (default).
 - **Picture quality** - Options: **Super fine** (default), **Fine**, **Normal**.
 - **Restore defaults** - Touch **Restore defaults** to restore all camera settings to the default values.
- **SCN Scene mode** - Touch to select a preset combination of camera settings designed for specific scenes. Options: **Auto** (default) or **Night**.







Video Settings

When in Video mode, Video settings are displayed on the screen. Touch  to change the video settings.

Video - Rear-facing Camera Settings

Touch  to display the camera setting options.

-  **Settings** - Touch to open a scrolling list of settings:

- **Store location** - Include location information with each photo using the ET1 global positioning system (GPS). Options: **On** or **Off** (default).
- **Restore defaults** - Touch to restore all camera settings to the default values.
- **Video quality** - Touch to select video quality:
 - **HD** - High definition 1080p.
 - **HD** - High definition 720p.
 - **SD** - Standard definition 480p (default).
- **Time lapse interval** — Touch to select a time interval to set the frame rate for time lapse photography. Options: **Off** (default), **1s**, **1.5s**, **2s**, **2.5s**, **3s**, **5s** or **10s**.
- **AW White balance** - Touch to select how the camera adjusts colors in different kinds of light, to achieve the most natural-looking colors for the video.
 - **AW Auto** - Adjust the white balance automatically (default).
 -  **Incandescent** - Adjust the white balance for incandescent lighting.
 -  **Daylight** - Adjust the white balance for daylight.
 -  **Fluorescent** - Adjust the white balance for florescent lighting.
 -  **Cloudy** - Adjust the white balance for a cloudy environment.
- **Flash mode** - Select to illuminate the video by turning on the camera flash.
 -  **On** - Enable flash.
 -  **Off** - Disable flash (default).

Video - Front-facing Camera Settings

Touch  to display the camera setting options.

-  **Camera Settings** - Touch to open a scrolling list of settings:
 - **Restore defaults** — Touch to restore all camera settings to the default values.
 - **Time lapse interval** — Touch to select a time interval to set the frame rate for time lapse photography. Options: **Off** (default), **1s**, **1.5s**, **2s**, **2.5s**, **3s**, **5s** or **10s**.

Viewing Photos and Videos





Note:

The ET1 supports the following image formats: jpeg, gif, png and bmp.

The ET1 supports the following video formats: H.263, H.264 and MPEG4 Simple Profile.

Use **Gallery** to:

- view photos
- play videos
- perform basic editing of photos
- set photos as wallpaper
- set photos as a contact photo
- share photos and videos.

To open the Gallery application, touch  >  or in the camera application touch the thumbnail image at the top right.

Gallery presents all photos and videos stored on the microSD card in albums.

Figure 45: Gallery — Albums



- Touch an album to open it and view its contents. The photos and videos in the album are displayed in chronological order.
- Touch a photo or video in an album to view it.
- Touch  icon (top left corner) to return to the main **Gallery** screen.

Working with Albums

Albums are groups of images and videos in folders. Touch an album to open it. The photos and videos are listed in a chronologically ordered grid. The name of the album displays at the top of the screen.



Figure 46: Photos Inside an Album



Swipe left or right to scroll images across the screen.



Share an Album

Procedure:

- 1 Touch .
- 2 Touch .
- 3 Touch and hold an album until it highlights.
- 4 Touch other albums as required.
- 5 Touch . The Share menu opens. Touch the application to use to share the selected albums.
- 6 Follow the instructions within the selected application.

Get Album Information



Procedure:

- 1 Touch .
- 2 Touch .
- 3 Touch and hold an album until it highlights.
- 4 Touch .
- 5 Touch **Details**.

Deleting an Album

To delete an album and its contents from the microSD card:

Procedure:

- 1 Touch .
- 2 Touch .
- 3 Touch and hold an album until it highlights.
- 4 Check other albums to delete. Ensure that other albums are selected.
- 5 Touch .
- 6 In the **Delete selected item?** menu, touch **OK** to delete the album.

Working with Photos

Use **Gallery** to view photos on the microSD card and edit and share photos.

Viewing and Browsing Photos

Procedure:



- 1 Touch .
- 2 Touch .
- 3 Touch an album to open it.
- 4 Touch a photo.

Figure 47: Photo Example



- 5 Swipe left or right to view the next or previous photo in the album.
- 6 Turn the ET1 to view the photo in upright (portrait) or sideways (landscape) orientation. The photo is displayed (but not saved) in the new orientation.
- 7 Touch the photo to view the controls.
- 8 Double-tap the screen to zoom in or pinch two fingers together or spread them apart to zoom in or out.

- 9 Drag the photo to view parts that are not in view.

Rotating a Photo

Procedure:

- 1 Touch a photo to view the controls.
- 2 Touch .
- 3 Touch **Rotate Left** or **Rotate Right**.
The photo is automatically saved with the new orientation.

Cropping a Photo

Procedure:

- 1 Touch a photo to view the controls.
- 2 Touch **Menu** > **Crop**. The blue cropping tool appears.
- 3 Use the cropping tool to select the portion of the photo to crop.
 - Drag from the inside of the cropping tool to move it.
 - Drag an edge of the cropping tool to resize it to any proportion.
 - Drag a corner of the cropping tool to resize it with fixed proportions.

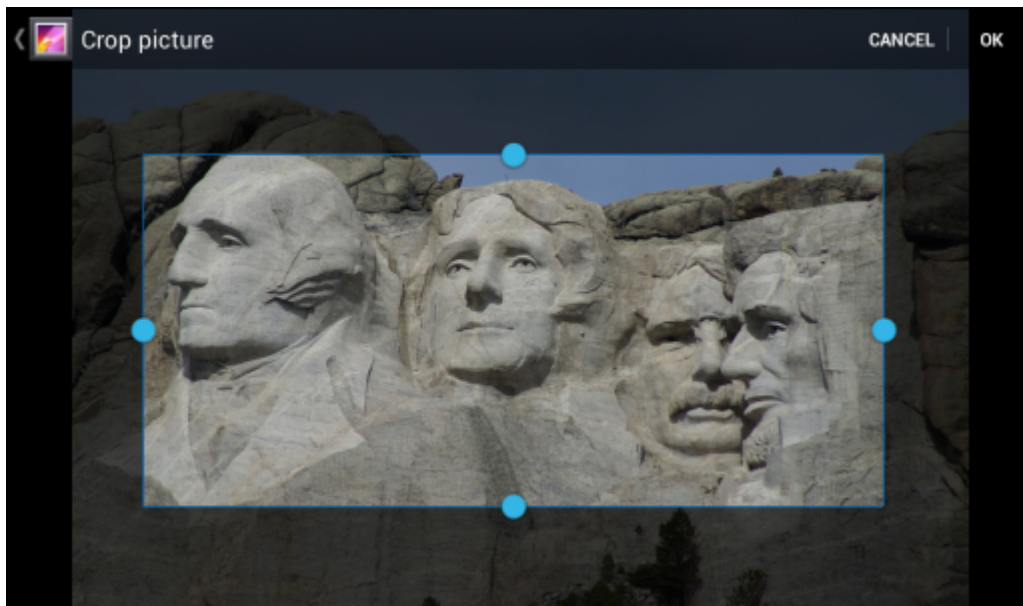

Figure 48: Cropping Tool



- 4 Touch **OK** to save a copy of the cropped photo. The original version is retained.

Setting a Photo as a Contact Icon



Procedure:

- 1 Touch .
- 2 Touch .
- 3 Touch an album to open it.
- 4 Touch the photo to open it.
- 5 Touch .

- 6 Touch **Set picture as**.
- 7 Touch **Contact photo**. The **People** app appears.
- 8 Touch a contact.
- 9 Touch the blue box and crop the photo accordingly.
- 10 Touch **OK**.



Get Photo Information

Procedure:

- 1 Touch .
- 2 Touch .
- 3 Touch an album to open it.
- 4 Touch the photo to open it.
- 5 Touch .
- 6 Touch **Details**.



Share a Photo

Procedure:

- 1 Touch .
- 2 Touch .
- 3 Touch an album to open it.
- 4 Touch a photo to open it.
- 5 Touch .
- 6 Touch the application to use to share the selected photo. The application selected opens with the photo attached to a new message.

Deleting a Photo

Procedure:

- 1 Touch .
- 2 Touch .
- 3 Touch an album to open it.
- 4 Touch a photo to open it.
- 5 Touch .
- 6 Touch **OK** to delete the photo.

Working with Videos

Use **Gallery** to view videos on the microSD card and share videos.

Watching Videos

Procedure:





- 1 Touch .
- 2 Touch .
- 3 Touch an album to open it.
- 4 Touch a video.



Figure 49: Video Example

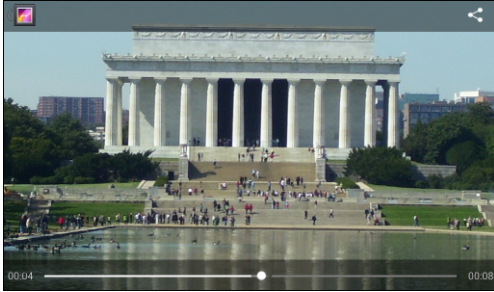

- 5 Touch . The video begins to play.
- 6 Touch the screen to view the playback controls.



Sharing a Video

Procedure:

- 1 Touch .
- 2 Touch .
- 3 Touch an album to open it.
- 4 Touch a video to open it.
- 5 Touch . The Share menu appears.
- 6 Touch the application to use to share the selected video. The application selected opens with the video attached to a new message.

Deleting a Video

Procedure:

- 1 Touch .
- 2 Touch .
- 3 Touch an album to open it.
- 4 Touch a video to open it.
- 5 Touch .
- 6 Touch **OK**.

Chapter 7

Accessories

This chapter provides information for using the accessories for the device.

ET1 Accessories

Table 8: ET1 Accessories on page 79 lists the accessories available for the ET1.

Table 8: ET1 Accessories

Accessory	Part Number	Description
Cradles		
Single-slot USB Docking Cradle	DC1000-1000U	Charges the ET1 main battery and a spare battery. Synchronizes the ET1 with a host computer through a USB connection.
Four-slot Charge Only Docking Cradle	DC1000-4000C	Charges up to four ET1 devices.
Chargers		
Four-slot Spare Battery Charger	SAC1000-4000C	Charges up to four ET1 battery packs.
Power Supply	PWRS-14000-148C	Provides power to the Single-slot USB Docking cradle or the USB/Charge cable. 12 VDC, 4.16 A.
Power Supply	PWRS-14000-241R	Provides power to the Four-slot Charge Only Docking cradle or the Four-slot Battery Charger. 12 VDC, 9 A.
Cables		
USB Charge Cable	25-153149-01R	Provides power to the ET1 and USB communication with a host computer.
DC Charge Cable	50-16002-029R	Connects one power supply to the one Four-slot Charge Only Docking Cradle or the Four-slot Battery Charger.
2-way Charge Cable	25-153150-01R	Connects one power supply to one Four-slot Charge Only Docking Cradle and one Four-slot Battery Charger or two Four-slot Battery Chargers.
US AC Line Cord (3-wire)	23844-00-00R	Provides power to the power supplies.
International AC line Cord	-	Provides power to the power supplies. Purchase separately.

Table continued...

Accessory	Part Number	Description
Miscellaneous		
Spare 4620 mAh lithium-ion battery	BTRY-ET01EAB0E	Replacement 4620 mAh battery for ET1N0.
	BTRY-ET01EAB0E-10	Replacement 4620 mAh battery for ET1N0 (10-pack)
Spare 5640 mAh lithium-ion battery	BTRY-ET01EAB0H	Replacement 5640 mAh battery for ET1N0 and ET1N2.
	BTRY-ET01EAB0H-10	Replacement 5640 mAh battery for ET1N0 and ET1N2 (10-pack).
Handstrap	SG-ET0123245-01R	Adjustable and 360-degree rotatable handstrap that mounts on the back of the ET1 and provides a secure option for holding the device.
Scanning Module	SCANMOD-ET1	Provides 2D bar code scanning.
Scanning/MSR Module	MSRSCAN-ET1	Provides 2D bar code scanning and magnetic stripe card reading.
Protective Rubber Bezel	KT-161552-01R	Add additional protection for the ET1.
Mobile Payment Module	MPM-100	Adds mobile point of sale capable of Chip and PIN, and MSR transactions to the ET1.

Single-slot USB Docking Cradle

The Single-slot USB Docking cradle:

- Provides 12 VDC power for operating the ET1.
- Synchronizes information between the ET1 and a host computer. See the *ET1 Enterprise Tablet Integrator Guide* for information on setting up a connection to a host computer.
- Charges the battery.

Charging the ET1 Battery

Connect the cradle to power, then insert the ET1 into the slot to begin charging.

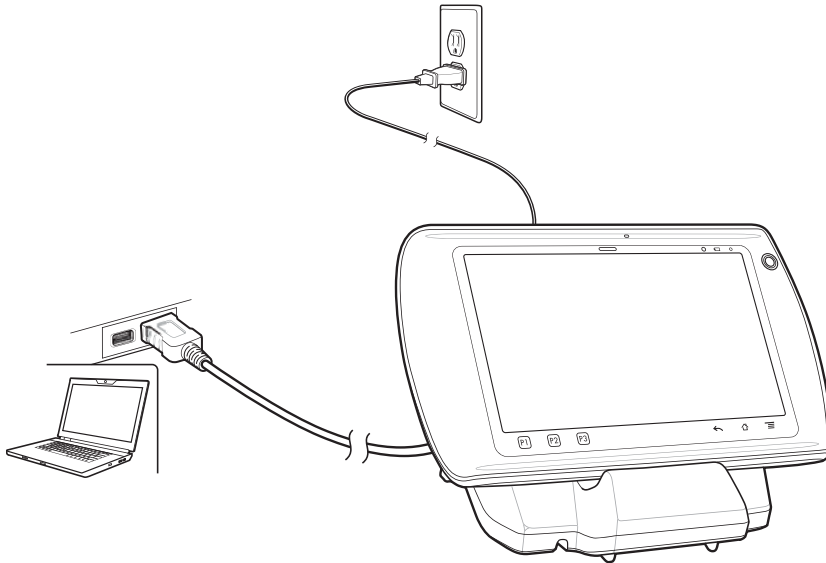
Figure 50: ET1 in Single-slot USB Docking Cradle

The ET1 charge Battery Charge light emitting diode (LED) indicates the status of the battery charging in the ET1. See [Table 2: Battery Charge LED Status on page 20](#) for charging status indications. The battery fully charges in approximately six hours.

Charge batteries in temperatures from 0 °C to 40 °C (32 °F to 104 °F). Charging is intelligently controlled by the ET1. To accomplish this charging, for small periods of time, the ET1 or accessory alternately enables and disables the battery charging to keep the battery at acceptable temperatures. The ET1 indicates when charging is disabled due to abnormal temperatures via Battery Charge LED. See [Table 2: Battery Charge LED Status on page 20](#).

Communication

When the ET1 is connected to a host computer using the Single-slot USB Docking cradle, the ET1 appears as a **Portable Device** on the host computer. Refer to the *ET1 Enterprise Tablet Integrator Guide* for more information.

Four-slot Charge Only Docking Cradle

The Four-slot Charge Only Docking cradle:

- Provides 12 VDC power for operating the ET1.
- Simultaneously charges up to four ET1 devices.

Charging the ET1 Battery

Insert the ET1 into a slot to begin charging.

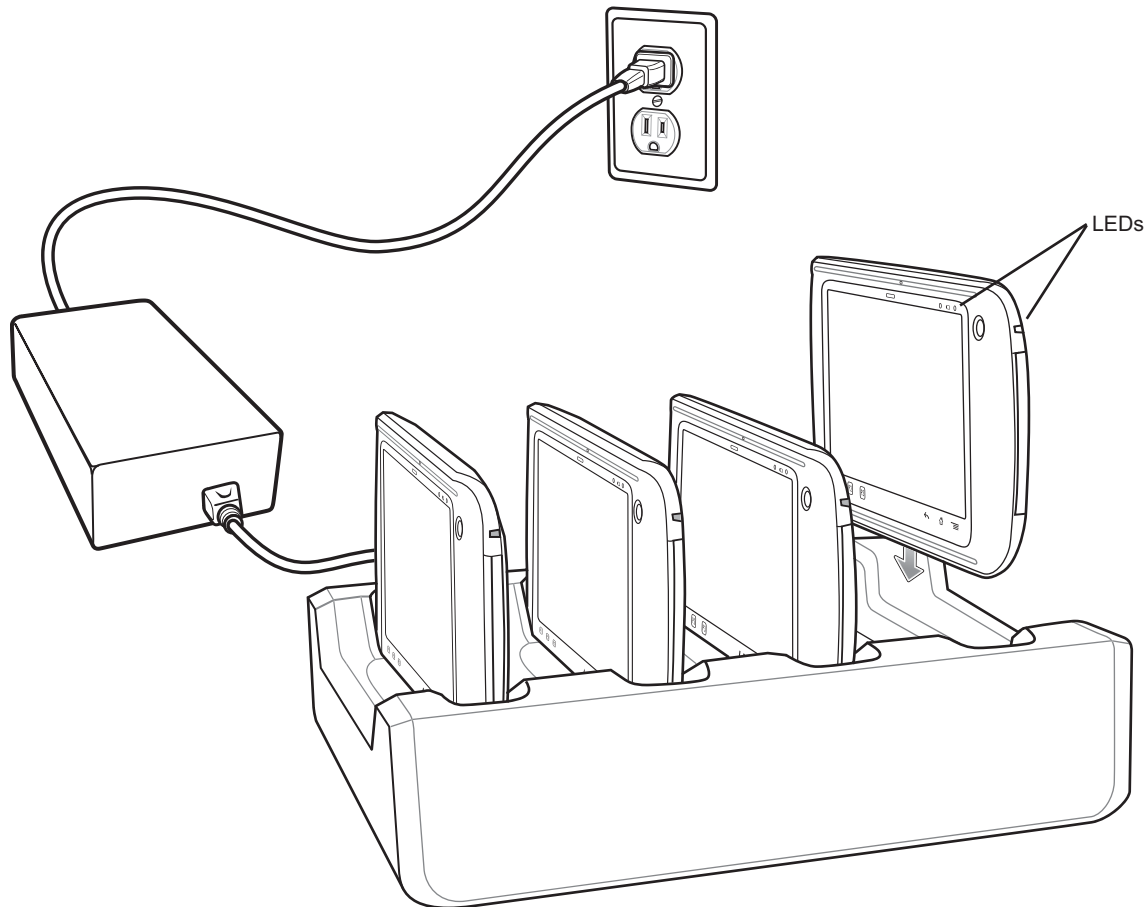
Figure 51: ET1 Battery Charging

The ET1's Battery Charge LED shows the status of the battery charging in the ET1. See [Table 2: Battery Charge LED Status on page 20](#) for charging status indications. The battery fully charges in approximately six hours.

Charge batteries in temperatures from 0 °C to 40 °C (32 °F to 104 °F). Charging is intelligently controlled by the ET1. To accomplish this, for small periods of time, the ET1 or accessory alternately enables and disables battery charging to keep the battery at acceptable temperatures. The ET1 indicates when charging is disabled due to abnormal temperatures via the Battery Charge LED. See [Table 2: Battery Charge LED Status on page 20](#).

Four-Slot Battery Charger

The Four-slot Battery Charger:

- Provides 12 VDC power for charging the batteries.
- Simultaneously charges up to four ET1 batteries.

Setup

Figure 52: Four-Slot Battery Charger Setup

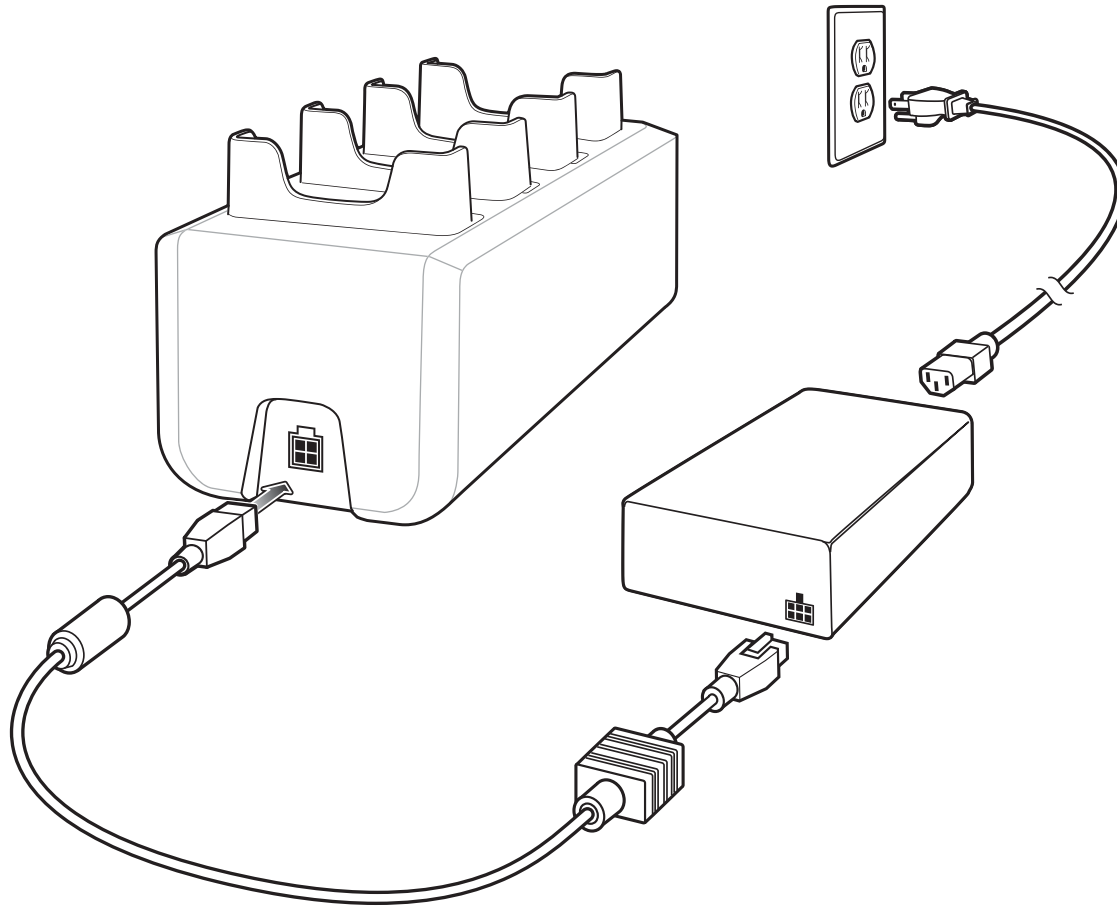

Charging the Batteries

Insert the spare battery into a spare battery charging well.

A Charge LED is provided for each battery charging well. See [Table 9: Battery LED Charging Indicators on page 84](#) for charging status indications. The 4620 mAh battery fully charges in approximately six hours.

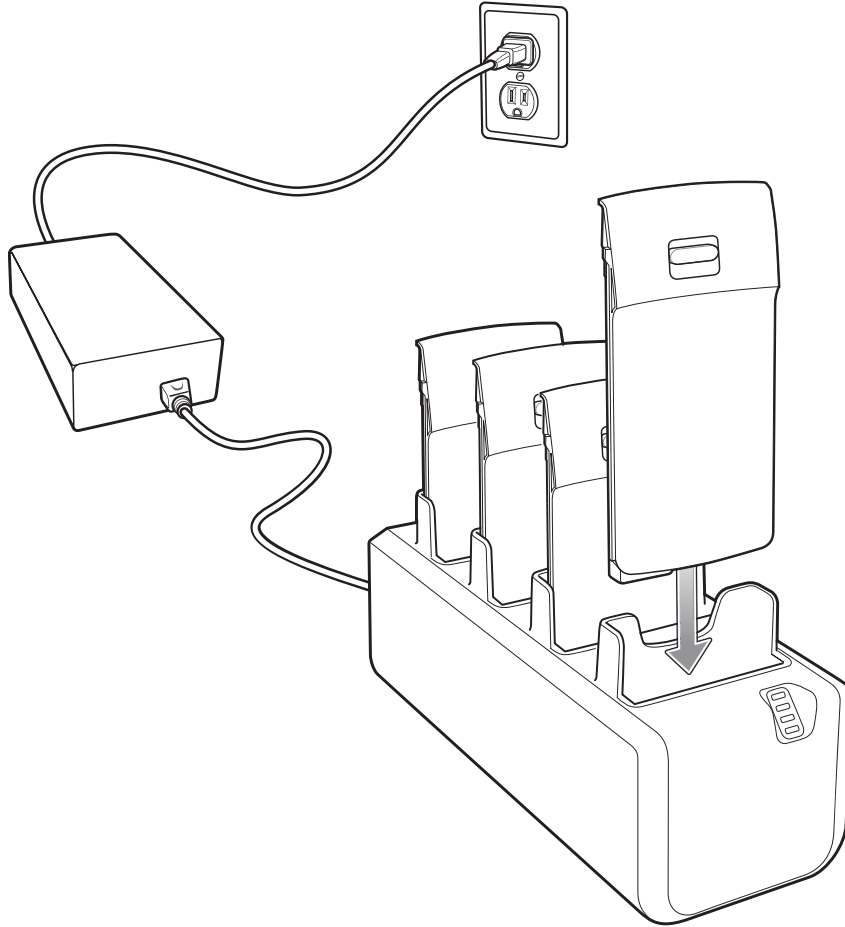
Figure 53: ET1 Battery Charging

Charge batteries in temperatures from 0 °C to 40 °C (32 °F to 104 °F). Charging is intelligently controlled by the charger in order to ensure safe operation and optimize long-term battery life. To accomplish this, for small periods of time, the charger alternately enables and disables battery charging to keep the battery at acceptable temperatures. The charger indicates when charging is disabled due to abnormal temperatures via the Charge LED. See [Table 9: Battery LED Charging Indicators on page 84](#).

Table 9: Battery LED Charging Indicators

LED	Indication
Off	No battery in slot. Battery is not charging. Battery is not inserted correctly in the charger. Charger is not powered.
Slow Blinking Amber	Battery is charging.
Solid Green	Charging complete.
Fast Blinking Amber	Charging error.

USB/Charge Cable

The USB/Charge cable:

- Provide the ET1 with operating and charging power.
- Synchronize information between the ET1 and a host computer.

Charging

Figure 54: Charging Using the USB/Charge Cable

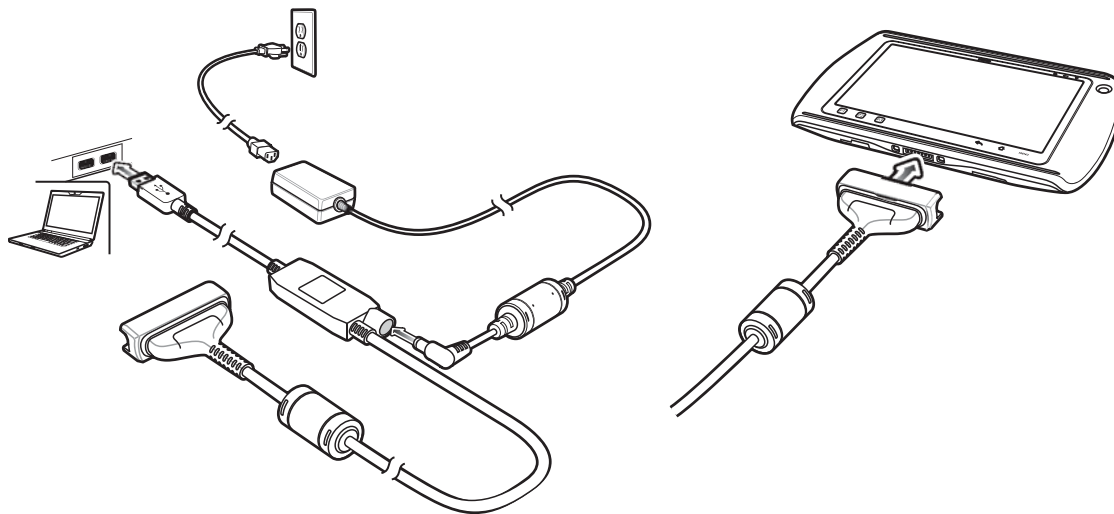

The Battery Charge LED indicates the battery charging status. See [Table 2: Battery Charge LED Status on page 20](#) for charging status indications. The battery charges in approximately six hours.

Charge batteries in temperatures from 0 °C to 40 °C (32 °F to 104 °F). Charging is intelligently controlled by the ET1. To accomplish this, for small periods of time, the ET1 alternately enables and disables battery charging to keep the battery at acceptable temperatures. The ET1 indicates when charging is disabled due to abnormal temperatures via the Battery Charge LED. See [Table 2: Battery Charge LED Status on page 20](#).

Communication

Use the USB/Charge Cable to communicate with a host computer.

Figure 55: Communication Using USB/Charge Cable

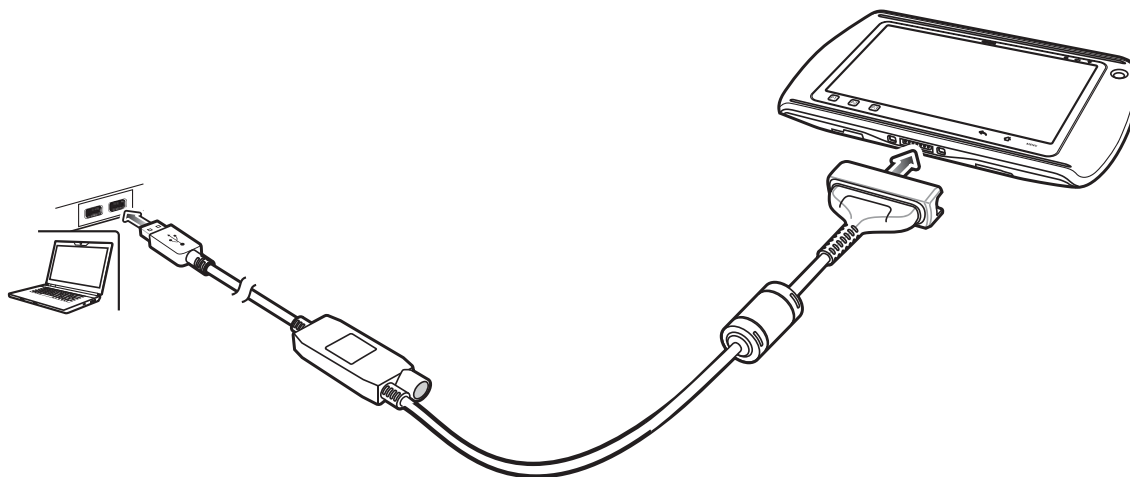

Connect the USB/Charge Cable cup to the bottom of the ET1. Align the ends of the cup with the alignment marks on the ET1.

When the ET1 is connected to a host computer using the USB/Charge cable, the ET1 appears as a **Portable Device** on the host computer.

Using the Host USB Module

The USB Host Module provides USB Host connection to a peripheral.

Procedure:

- 1 Lift the connector plug on the USB Host Module.
- 2 Connect the microUSB connector to the USB Host Module.

Figure 56: USB Host Module Connection

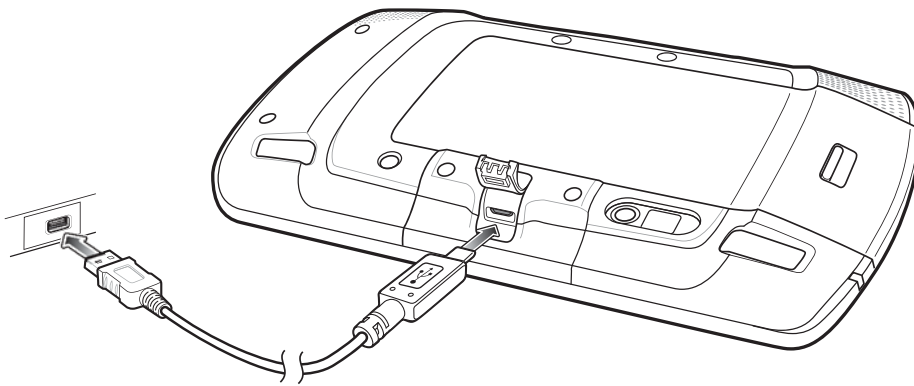

- 3 Connect the USB/Charge Cable cup to the bottom of the ET1. Align the ends of the cup with the alignment marks on the ET1.

When the ET1 is connected to a host computer using the USB/Charge cable, the ET1 appears as a **Removable Disk** on the host computer.

Chapter

8

Maintenance and Troubleshooting

This chapter includes instructions on cleaning and storing the device, and provides troubleshooting solutions for potential problems during operation.

Maintaining the ET1

For trouble-free service, observe the following tips when using the ET1:

- Do not scratch the screen of the ET1. When working with the ET1, use a finger or approved stylus or pen intended for use with a capacitive touch-sensitive screen. Never use an actual pen or pencil or other sharp object on the surface of the ET1 screen.
- The touch-sensitive screen of the ET1 is glass. Do not drop the ET1 or subject it to strong impact.
- Protect the ET1 from temperature extremes. Do not leave it on the dashboard of a car on a hot day, and keep it away from heat sources.
- Do not store or use the ET1 in any location that is dusty, damp, or wet.
- Use a soft lens cloth to clean the ET1. If the surface of the ET1 screen becomes soiled, clean it with a soft cloth moistened with a diluted window-cleaning solution.
- Periodically replace the rechargeable battery to ensure maximum battery life and product performance. Battery life depends on individual usage patterns.

Battery Safety Guidelines

- The area in which the units are charged should be clear of debris and combustible materials or chemicals. Particular care should be taken where the device is charged in a non commercial environment.
- Follow battery usage, storage, and charging guidelines found in this guide.
- Improper battery use may result in a fire, explosion, or other hazard.
- To charge the mobile device battery, the battery and charger temperatures must be between +32 °F and +104 °F (0 °C and +40 °C)
- Do not use incompatible batteries and chargers. Use of an incompatible battery or charger may present a risk of fire, explosion, leakage, or other hazard. If you have any questions about the compatibility of a battery or a charger, contact the Global Customer Support Center.
- For devices that utilize a USB port as a charging source, the device shall only be connected to products that bear the USB-IF logo or have completed the USB-IF compliance program.
- To enable authentication of an approved battery, as required by IEEE1725 clause 10.2.1, all batteries will carry a hologram. Do not fit any battery without checking it has the authentication hologram.
- Do not disassemble or open, crush, bend or deform, puncture, or shred.
- Severe impact from dropping any battery-operated device on a hard surface could cause the battery to overheat.
- Do not short circuit a battery or allow metallic or conductive objects to contact the battery terminals.
- Do not modify or remanufacture, attempt to insert foreign objects into the battery, immerse or expose to water or other liquids, or expose to fire, explosion, or other hazard.

- Do not leave or store the equipment in or near areas that might get very hot, such as in a parked vehicle or near a radiator or other heat source. Do not place battery into a microwave oven or dryer.
- Battery usage by children should be supervised.
- Please follow local regulations to properly dispose of used re-chargeable batteries.
- Do not dispose of batteries in fire.
- In the event of a battery leak, do not allow the liquid to come in contact with the skin or eyes. If contact has been made, wash the affected area with large amounts of water and seek medical advice.
- If you suspect damage to your equipment or battery, contact the Global Customer Support Center to arrange for inspection.

Cleaning Instructions



Caution:

Always wear eye protection.

Read warning label on compressed air and alcohol product before using.

If you have to use any other solution for medical reasons please contact the Global Customer Support Center for more information.



Warning: Avoid exposing this product to contact with hot oil or other flammable liquids. If such exposure occurs, unplug the device and clean the product immediately in accordance with these guidelines.

Approved Cleanser Active Ingredients

100% of the active ingredients in any cleaner must consist of one or some combination of the following: isopropyl alcohol, bleach/sodium hypochlorite, hydrogen peroxide or mild dish soap.

Harmful Ingredients

The following chemicals are known to damage the plastics on the device and should not come in contact with the device: ammonia solutions, compounds of amines or ammonia; acetone; ketones; ethers; aromatic and chlorinated hydrocarbons; aqueous or alcoholic alkaline solutions; ethanolamine; toluene; trichloroethylene; benzene; carbolic acid and TB-lysoform.

Cleaning Instructions

Do not apply liquid directly to the device. Dampen a soft cloth or use pre-moistened wipes. Do not wrap the device in the cloth or wipe, but gently wipe the unit. Be careful not to let liquid pool around the display window or other places. Allow the unit to air dry before use.

Special Cleaning Notes

Many vinyl gloves contain phthalate additives, which are often not recommended for medical use and are known to be harmful to the housing of the device. The device should not be handled while wearing vinyl gloves containing phthalates, or before hands are washed to remove contaminant residue after gloves are removed. If products containing any of the harmful ingredients listed above are used prior to handling the device, such as hand sanitizer that contain ethanolamine, hands must be completely dry before handling the device to prevent damage to the plastics.

Cleaning Materials Required

- Alcohol wipes
- Lens tissue
- Cotton-tipped applicators
- Isopropyl alcohol

- Can of compressed air with a tube.

Cleaning Frequency

The cleaning frequency is up to the customer's discretion due to the varied environments in which the mobile devices are used. They may be cleaned as frequently as required, but it is advisable to clean the camera window periodically when used in dirty environments to ensure optimum performance.

Cleaning the ET1

Housing

Using the alcohol wipes, wipe the housing including keys and in-between keys.

Display

The display can be wiped down with the alcohol wipes, but care should be taken not to allow any pooling of liquid around the edges of the display. Immediately dry the display with a soft, non-abrasive cloth to prevent streaking.

Camera Window

Wipe the camera window periodically with a lens tissue or other material suitable for cleaning optical material such as eyeglasses.

Connector Cleaning

To clean the connectors:

Procedure:

- 1 Remove the main battery from mobile computer.
- 2 Dip the cotton portion of the cotton-tipped applicator in isopropyl alcohol.
- 3 Rub the cotton portion of the cotton-tipped applicator back-and-forth across the connector. Do not leave any cotton residue on the connector.
- 4 Repeat at least three times.
- 5 Use the cotton-tipped applicator dipped in alcohol to remove any grease and dirt near the connector area.
- 6 Use a dry cotton-tipped applicator and repeat steps 4 through 6.



Caution: Do not point nozzle at yourself and others, ensure the nozzle or tube is away from your face.

- 7 Spray compressed air on the connector area by pointing the tube/nozzle about ½ inch away from the surface.
- 8 Inspect the area for any grease or dirt, repeat if required.

Cleaning Cradle Connectors

To clean the connectors on a cradle:

Procedure:

- 1 Remove the DC power cable from the cradle.
- 2 Dip the cotton portion of the cotton-tipped applicator in isopropyl alcohol.
- 3 Rub the cotton portion of the cotton-tipped applicator along the pins of the connector. Slowly move the applicator back-and-forth from one side of the connector to the other. Do not leave any cotton residue on the connector.
- 4 All sides of the connector should also be rubbed with the cotton-tipped applicator.



Caution: Do not point nozzle at yourself and others, ensure the nozzle or tube is pointed away from your face.

- 5 Spray compressed air in the connector area by pointing the tube/nozzle about ½ inch away from the surface.
- 6 Remove any lint left by the cotton-tipped applicator.
- 7 If grease and other dirt can be found on other areas of the cradle, use a lint-free cloth and alcohol to remove.
- 8 Allow at least 10 to 30 minutes (depending on ambient temperature and humidity) for the alcohol to air dry before applying power to cradle.

If the temperature is low and humidity is high, longer drying time is required. Warm temperature and dry humidity requires less drying time.

Troubleshooting



The following tables provides typical problems that might arise and the solution for correcting the problem.

Troubleshooting the ET1 Enterprise Tablet

Table 10: Troubleshooting the ET1 Enterprise Tablet

Problem	Cause	Solution
When the user presses the Power button, the ET1 does not turn on.	Battery is completely discharged.	Re-charge or replace the battery.
	Battery not installed properly.	Install the battery properly. See Installing the Battery on page 19 .
	Power button not held down long enough.	Press the Power button until the Battery Charge LED flashes three times.
	ET1 not responding.	Perform a hard reset. See Performing a Hard Reset on page 45 .
When the user presses the Power button the ET1 does not turn on but the Decode LED blinks yellow.	Battery charge level is very low.	Re-charge or replace the battery.
Battery did not charge.	Battery failed.	Replace battery. If the ET1 still does not operate, perform a hardware reset. Simultaneously press the Power, Left Scan/Action and Right Scan/Action buttons.
	ET1 was removed from cradle while battery was charging.	Insert ET1 in cradle. The 4620 mAh battery fully charges in less than six hours.
	Extreme battery temperature.	Battery does not charge if ambient temperature is below 0°C (32°F) or above 40°C (104°F).
During data communication, no data transmitted, or transmitted data was incomplete.	ET1 removed from cradle or disconnected from host com-	Replace the ET1 in the cradle, or reattach the communication cable and re-transmit.

Table continued...

Problem	Cause	Solution
	puter during communication.	
	Incorrect cable configuration.	See the system administrator.
No sound.	Volume setting is low or turned off.	Adjust the volume.
ET1 turns off.	ET1 is inactive.	The display turns off after a period of inactivity. Set this period to 15 seconds, 30 seconds, 1, 2, 10, or 30 minutes.
	Battery is depleted.	Recharge or replace the battery.
A message appears stating not enough storage memory.	Too many applications installed on the ET1.	Remove user-installed applications on the ET1 to recover memory. Select  >  Apps > Downloaded . Select the unused programs and touch Uninstall .
The ET1 does not decode when reading bar code.	DataWedge is not enabled.	Ensure that DataWedge is enabled and configured properly. Refer to the <i>ET1 Enterprise Tablet Integrator Guide</i> for more information.
	Unreadable bar code.	Ensure the symbol is not defaced.
	Distance between the ET1 and bar code is incorrect.	Place the ET1 within proper scanning range.
	ET1 is not programmed for the bar code type.	Program the ET1 to accept the type of bar code being scanned. Refer to the ET1 Enterprise Tablet Integrator Guide for DataWedge configuration.
	ET1 is not programmed to generate a beep.	If the ET1 does not beep on a good decode, set the application to generate a beep on good decode.
ET1 does not read magnetic stripe card.	Magnetic stripe on card is facing the wrong way.	Ensure that magnetic stripe card is oriented correctly. Magnetic stripe of card should be facing the display.
	MSR reading is not enabled.	Program the ET1 to accept MSR input. Refer to the <i>ET1 Enterprise Tablet Integrator Guide</i> for DataWedge configuration.
ET1 cannot find any Bluetooth devices nearby.	Too far from other Bluetooth devices.	Move closer to the other Bluetooth device(s), within a range of 10 meters (30 feet).
	The Bluetooth device(s) nearby are not turned on.	Turn on the Bluetooth device(s) to find.
	The Bluetooth device(s) are not in discoverable mode.	Set the Bluetooth device(s) to discoverable mode. If needed, refer to the device's user documentation for help.





Single-slot USB Docking Cradle Troubleshooting

Table 11: Troubleshooting the Single-slot USB Docking Cradle

Problem	Cause	Solution
ET1 battery is not charging.	ET1 was removed from cradle or cradle was unplugged from AC power too soon.	Ensure cradle is receiving power. Ensure ET1 is seated correctly. Confirm the battery is charging. The battery fully charges in less than six hours.
	Battery is faulty.	Verify that other batteries charge properly. If so, replace the faulty battery.
	The ET1 is not fully seated in the cradle.	Remove and re-insert the ET1 into the cradle, ensuring it is firmly seated.
	Extreme battery temperature.	Battery does not charge if ambient temperature is below 0 °C (32 °F) or above 40 °C (104 °F).
During data communication, no data transmits, or transmitted data was incomplete.	ET1 removed from cradle during communications.	Replace ET1 in cradle and retransmit.
	Communication software is not installed or configured properly.	Perform setup as described in the <i>ET1 Enterprise Tablet Integrator Guide</i> .

Four-slot Charge Only Docking Cradle Troubleshooting

Table 12: Troubleshooting the Four-slot Charge Only Docking Cradle

Problem	Cause	Solution
Battery is not charging.	ET1 removed from the cradle too soon.	Replace the ET1 in the cradle. The battery fully charges in less than six hours. Touch  >  About device > Status to view battery status.
	Battery is faulty.	Verify that other batteries charge properly. If so, replace the faulty battery.
	ET1 is not inserted correctly in the cradle.	Remove the ET1 and reinsert it correctly. Verify charging is active. Touch  >  About device > Status to view battery status.
	Ambient temperature of the cradle is too warm.	Move the cradle to an area where the ambient temperature is between 0 °C (32 °F) and 35 °C (95 °F).



Four-slot Battery Charger Troubleshooting

Table 13: Troubleshooting the Four-slot Battery Charger

Problem	Cause	Solution
Battery not charging.	Battery was removed from the charger or charger was unplugged from AC power too soon.	Re-insert the battery in the charger or re-connect the charger's power supply. The battery fully charges in less than six hours.
	Battery is faulty.	Verify that other batteries charge properly. If so, replace the faulty battery.
	Battery contacts not connected to charger.	Verify that the battery is seated in the battery well correctly with the contacts facing down.

USB/Charge Cable Troubleshooting

Table 14: Troubleshooting the USB/Charge Cable

Problem	Cause	Solution
Battery not charging.	ET1 was disconnected from AC power too soon.	Connect the power cable correctly. Confirm main battery is charging under  >  About device > Status . The battery fully charges in less than six hours.
	Battery is faulty.	Verify that other batteries charge properly. If so, replace the faulty battery.
	The ET1 is not connected to power.	Detach and re-attach the power cable to the ET1, ensuring it is firmly connected.
During data communication, no data transmits, or transmitted data was incomplete.	Cable was disconnected from ET1 during communications.	Re-attach the cable and retransmit.
	Incorrect cable configuration.	See the system administrator.
	Communication software is not installed or configured properly.	Perform setup as described in the <i>ET1 Enterprise Tablet Integrator Guide</i> .

Appendix

A

Technical Specifications

The following sections provide technical specification for the device.

ET1 Technical Specifications

The following table summarize the ET1's intended operating environment and technical hardware specifications.

Table 15: ET1 Technical Specifications

Item	Description
Physical Characteristics	
Dimensions (with USB Host Expansion Module)	Height: 130.5 mm (5.14 in.)
	Width: 224 mm (8.82 in.)
	Depth: 25 mm (0.98 in.)
Weight	ET1N0: 630 g (22.4 oz.)
	ET1N2: 706 g (24.9 oz.)
Display	7 in. capacitive; 1024 x 600; 350 nit; Corning® Gorilla® Glass.
Touch Panel	Capacitive multi-touch.
Backlight	LED backlight.
Battery Pack	Rechargeable Lithium Ion 3.7V, 4620 mAh or 5640 mAh Smart battery.
Backup Battery	NiMH battery (rechargeable) 15 mAh 3.6 V (not user accessible).
Expansion Slot	User accessible microSD slot, up to 32 GB.
Connectivity	Two USB interfaces: one USB 2.0 OTG connector (docking connector) and one USB 2.0 Host connector (expansion module port); HDMI output; communication via cradle and expansion ports; USB 2.0 host via expansion module.
Notification	LED, audio and vibration.
Keypad Options	On-screen keyboard.
Audio	Stereo speakers, microphone and headset connector (mono, 2.5 mm jack with microphone.)
Performance Characteristics	

Table continued...

Item	Description
CPU	Texas Instruments OMAP 4430 @ 1 GHz.
Operating System	Android-based ASOP 4.1.1.
Memory	1GB RAM, 4 GB Flash plus 4 GB microSD; user accessible microSD card slot (supports up to 32 GB).
Output Power (USB)	Docking Connector: 5 VDC @ 500 mA max. Expansion Module: 5 VDC @ 500 mA max.
User Environment	
Operating Temperature	0°C to 50°C (32°F to 122°F)
Storage Temperature	-40°C to 70°C (-40°F to 158°F)
Charging Temperature	0° C to 40° C (32°F to 104°F)
Humidity	10% to 95% RH non-condensing
Drop Specification	Multiple 1.2 m (4 ft.) drops per MIL-STD 810G specifications.
Electrostatic Discharge (ESD)	+/-15kVdc air discharge, +/-8kVdc direct discharge, +/-8kVdc indirect discharge
Sealing	IP54
Wireless LAN Data Communications	
Wireless Local Area Network (WLAN) radio	IEEE® 802.11a/b/g/n with internal antenna.
Data Rates Supported	1, 2, 5.5, 6, 9, 11, 12, 18, 24, 36, 48, and 54 Mbps. Note that 802.11n data rates may be higher.
Operating Channels	Chan 36-165 (5180 – 5825 MHz), Chan 1-13 (2412-2472 MHz); actual operating channels/frequencies depend on regulatory rules and certification agency.
Security	Security Modes: Legacy, WPA and WPA2 Encryption: WEP (40 and 128 bit), TKIP and AES Authentication: TLS, LEAP, EAP-FAST (MS-CHAP v2), EAP-FAST (GTC), EAP-PEAP (MSCHAPv2), EAP-PEAP (GTC), EAP-TTLS (PAP), EAP-TTLS (MSCHAP) and EAP-TTLS (MSCHAPv2).
Spreading Technique	Direct Sequence Spread Spectrum (DSSS) and Orthogonal Frequency Division Multiplexing (OFDM).
Wireless PAN Data and Voice Communications	
Bluetooth	Class II, v 2.1 with EDR; integrated antenna.
Wireless WAN Data (ET1N2 only)	
Wireless Wide Area Network	Data only: 3.5G GSM HSDPA and 3.5G CDMA-EVDO Rev A.
Data Capture	
Rear-facing Camera	For bar code scanning and image capture: 8 MP auto-focus camera with user controllable LED flash, illumination and aiming; captures 1D and 2D bar codes, photographs, video, signatures and documents.
Front-facing Camera	VGA camera optimized for video collaboration and low lighting condition.

Table continued...

Item	Description
Scanning Module	For bar code scanning.
Scanning/MSR Module	For bar code scanning and reading magnetic stripe cards.
Sensors	
Gyroscope	Maintains orientation based on principles of conservation of angular momentum.
Motion Sensor	3-axis accelerometer that enables motion sensing applications for dynamic screen orientation and power management.
Ambient Light Sensor	Automatically adjusts display brightness.
Electronic Compass	Independent — does not depend on GPS.
Scanning / Scanning/MSR Module (SE4500-DL) Specifications	
Field of View	Horizontal - 39.2° Vertical - 25.4°
Optical Resolution	WVGA 752 H x 480 V pixels (gray scale)
Roll	360°
Pitch Angle	+/- 60° from normal
Skew Tolerance	+/- 60° from normal
Ambient Light	Outdoor: 9000 ft. candles (96,900 lux)
Focal Distance	From center of exit window: 18.5 cm (7.3 in.)
Aiming Element (VLD)	655 nm +/- 10 nm
Illumination Element (LED)	625 nm +/- 5 nm
Supported Symbolologies	
1D	Chinese 2 of 5, Codabar, Code 11, Code 128, Code 39, Code 93, Discrete 2 of 5, EAN-8, EAN-13, GS1 DataBar, GS1 DataBar Expanded, GS1 DataBar Limited, Interleaved 2 of 5, Korean 2 of 5, MSI, TLC 39, Matrix 2 of 5, Trioptic, UPCA, UPCE, UPCE1, Web Code.
2D	Australian Postal, Aztec, Canadian Postal, Composite AB, Composite C, Data Matrix, Dutch Postal, Japan Postal, Maxicode, Micro PDF, Micro QR, PDF, QR Code, UK Postal, US Planet, US Postnet, US4State, US4State FICS.

Single-slot USB Docking Cradle Technical Specifications

The following table summarize the ET1's intended operating environment and technical hardware specifications.

Table 16: Single-slot USB Docking Cradle Technical Specifications

Item	Description
Dimensions (with USB Host Expansion Module)	Height: 61.62 mm (2.43 in.) Width: 151.9 mm (5.98 in.)

Table continued...

Item	Description
	Depth: 138.39 mm (5.45 in.)
Weight	620 g (21.87 oz)
Input Voltage	12 VDC
Power Consumption (with ET1)	24 watts
Interface	USB
Operating Temperature	0°C to 50°C (32°F to 122°F)
Storage Temperature	-40°C to 70°C (-40°F to 158°F)
Charging Temperature	0°C to 40°C (32°F to 104°F)
Humidity	5% to 95% non-condensing
Drop	76.2 cm (30.0 in.) drops to vinyl tiled concrete at room temperature
Electrostatic Discharge (ESD)	+/- 15 kV air +/- 8 kV contact

Four-slot Charge Only Cradle Technical Specifications

Table 17: Four-slot Charge Only Cradle Technical Specifications

Item	Description
Dimensions (with USB Host Expansion Module)	Height: 83.45 mm (3.29 in.) Width: 243.28 mm (9.58 in.) Depth: 330.17 mm (13.00 in.)
Weight	1.678 kg (3.70 lbs.)
Input Voltage	12 VDC
Power Consumption (with ET1)	50 watts
Operating Temperature	0 °C to 50 °C (32 °F to 122 °F)
Storage Temperature	-40 °C to 70 °C (-40 °F to 158 °F)
Charging Temperature	0 °C to 40 °C (32 °F to 104 °F)
Humidity	5% to 95% non-condensing
Drop	76.2 cm (30.0 in.) drops to vinyl tiled concrete at room temperature
Electrostatic Discharge (ESD)	+/- 15 kV air +/- 8 kV contact

Four-slot Battery Charger Technical Specifications

Table 18: Four-slot Battery Charger Technical Specifications

Item	Description
Dimensions (with USB Host Expansion Module)	Height: 110.62 mm (4.36 in.) Width: 100.88 mm (3.97 in.) Depth: 245.15 mm (9.65)
Weight	580 g (20.46 in.)
Input Voltage	12 VDC
Power Consumption (with ET1)	25 watts
Operating Temperature	0 °C to 40 °C (32 °F to 104 °F)
Storage Temperature	-40 °C to 70 °C (-40 °F to 158 °F)
Charging Temperature	0 °C to 40 °C (32 °F to 104 °F)
Humidity	5% to 95% non-condensing
Drop	76.2 cm (30.0 in.) drops to vinyl tiled concrete at room temperature
Electrostatic Discharge (ESD)	+/- 15 kV air +/- 8 kV contact

USB/Charge Cable Technical Specifications

Table 19: USB/Charge Cable Technical Specifications

Item	Description
Length	160.0 cm (63.0 in.)
Operating Temperature	0 °C to 40 °C (32 °F to 104 °F)
Storage Temperature	-40 °C to 70 °C (-40 °F to 158 °F)
Humidity	10% to 95% non-condensing
Electrostatic Discharge (ESD)	+/- 15 kV air +/- 8 kV contact

Index

2-way charge cable [79](#)

A

action button [17](#)
 activation
 CDMA [21](#)
 GSM [21](#)
 WAN [21](#)
 adaptive frequency hopping [61](#)
 airplane mode [62](#)
 albums [72](#)
 application shortcuts [35](#)
 applications [40](#)
 applock administrator [41](#)
 approved cleanser [88](#)

B

back button [17](#)
 battery
 charging [19](#)
 charging temperature [20](#)
 low battery notification [25](#)
 management [25](#)
 replacement [22](#)
 battery charge LED [16](#)
 battery installation [19](#)
 bezel [80](#)
 bluetooth
 changing name [64](#)
 connecting to a device [64](#)
 disable [63](#)
 discovering devices [63](#)
 enable [62](#)
 profiles [65](#)
 unpairing [65](#)
 Bluetooth
 PIN [61](#)
 security [61](#)
 bluetooth power states [62](#)
 browser [40](#)

C

calculator [40](#)
 calendar [40](#)
 camera
 front-facing [16](#)
 rear-facing [17](#)
 camera flash [17](#)
 camera scanning [54](#)
 camera settings [69](#)
 CDMA activation [21](#)
 charging
 four-slot charge only cradle [81](#)
 cleaning [88](#)

cleaning instructions [88](#)
 clock [40](#)
 communication [85](#)
 communication LED [16](#)
 configuration [11](#)
 contacts [41](#)
 cradle
 connector cleaning [89](#)
 creating folders [36](#)
 CS3070 [11](#), [51](#), [52](#)

D

data capture [51](#)
 data capture options [11](#)
 datawedge [40](#), [51](#), [56](#)
 date [27](#)
 DC charge cable [79](#)
 decode mode [51](#)
 default notifications [30](#)
 deleting a message [49](#)
 dial-up networking profile [62](#)
 digital camera [51](#)
 display
 cleaning [89](#)
 downloads [40](#)
 DWdemo [40](#), [42](#)

E

email [40](#)
 entering text [39](#)

F

file browser [40](#), [46](#)
 font [28](#)
 forwarding a message [48](#)
 four-slot battery charger [82](#)
 four-slot charge only cradle [79](#)
 four-slot charge only docking cradle [81](#)
 four-slot spare battery charger [79](#)

G

gallery [40](#)
 generic access profile [62](#)
 getting started [15](#)
 GSM activation [21](#)

H

handstrap [24](#), [80](#)
 hard reset [46](#)
 harmful ingredients [88](#)
 headset jack [17](#)
 home button [16](#)

home screen [31](#)
 Host USB module [86](#)
 human interface device profile [62](#)

I

I/O connector [17](#)

K

keyboard [38](#)

L

laser scanning [52](#)
 light sensor [16](#)

M

main battery charging [19](#)
 memory [11](#)
 menu button [16](#)
 messaging
 notifications [49](#)
 messaging settings [49](#)
 microphone [16](#)
 microSD card
 replacement [22](#)
 MSP agent [41](#)
 multiuser administrator [41](#)
 multiuser login [44](#)
 multiuser logout [45](#)
 music [41](#)

N

naming folders [36](#)
 notification icons [32](#)
 notification panel [35](#)

O

operating system [11](#)

P

panoramic [68](#)
 password [43](#)
 photos [67](#)
 picklist mode [51](#)
 PIN [43](#)
 power button [17, 20](#)
 protective rubber bezel [80](#)

R

radios [11](#)
 rapid deployment [41](#)
 recent applications [42](#)
 recording videos [68](#)

removing a folder [37](#)
 replacing the battery [22](#)
 replacing the microSD card [22](#)
 resetting [45](#)
 responding to a message [48](#)
 resume [62](#)
 rotate screen [28](#)

S

scan angle [52](#)
 scan button [17](#)
 scanning [52](#)
 scanning module [11, 51, 80](#)
 scanning range [52](#)
 scanning/MSR module [11, 51](#)
 screen brightness [26](#)
 screen lock sounds [30](#)
 screen rotation [28](#)
 screen timeout [26, 28](#)
 search [41](#)
 secure storage administrator [42](#)
 sending a text message [48](#)
 serial port profile [62](#)
 service [13](#)
 service discovery protocol [62](#)
 setting
 camera [69](#)
 setting font size [28](#)
 settings [41](#)
 setup [18](#)
 side LED [17](#)
 SIM card [18](#)
 SIM card installation [18](#)
 single user mode [42](#)
 single-slot USB docking cradle [79](#)
 soft reset [45](#)
 spare battery [80](#)
 spare battery charging [20](#)
 speakers [17](#)
 status bar [32](#)
 status icons [32](#)
 suspend [62](#)
 system sounds [30](#)

T

taking a panoramic photo [68](#)
 taking photos [67](#)
 text message limit [49](#)
 time [27](#)
 touch screen [17](#)
 troubleshooting [90](#)
 turning off radios [26](#)

U

unpacking [17](#)
 USB charge cable [79](#)
 USB communication [85](#)
 USB host mode [86](#)
 USB/charge cable [85](#)

user guide [41](#)

V

vibrate on touch [30](#)

videos [67](#), [68](#)

volume [29](#)

W

WAN activation [21](#)

WLAN [59](#)



Zebra Technologies Corporation
Lincolnshire IL, U.S.A.
<http://www.zebra.com>

Zebra and the Zebra head graphic are registered trademarks of ZIH Corp. The Symbol logo is a registered trademark of Symbol Technologies, Inc., a Zebra Technologies company.
© 2015 Symbol Technologies, Inc.

