

MC40 USER GUIDE

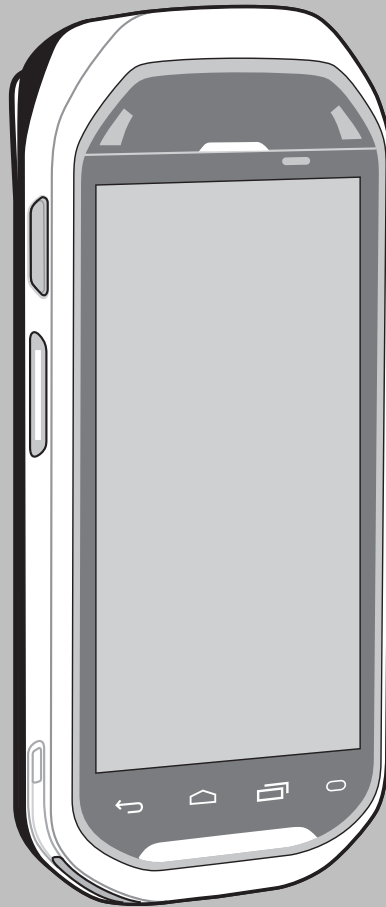
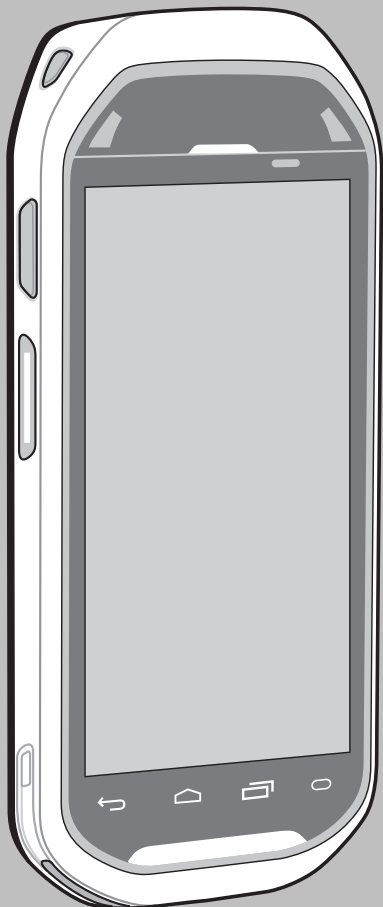

Copyrights

The products described in this document may include copyrighted computer programs. Laws in the United States and other countries preserve for certain exclusive rights for copyrighted computer programs. Accordingly, any copyrighted computer programs contained in the products described in this document may not be copied or reproduced in any manner without the express written permission.

© 2015 Symbol Technologies, Inc. All Rights Reserved

No part of this document may be reproduced, transmitted, stored in a retrieval system, or translated into any language or computer language, in any form or by any means, without the prior written permission.

Furthermore, the purchase of our products shall not be deemed to grant either directly or by implication, estoppel or otherwise, any license under the copyrights, patents or patent applications, except for the normal non-exclusive, royalty-free license to use that arises by operation of law in the sale of a product.

Disclaimer

Please note that certain features, facilities, and capabilities described in this document may not be applicable to or licensed for use on a particular system, or may be dependent upon the characteristics of a particular mobile subscriber unit or configuration of certain parameters. Please refer to your contact for further information.

Trademarks

Zebra and the Zebra head graphic are registered trademarks of ZIH Corp. The Symbol logo is a registered trademark of Symbol Technologies, Inc., a Zebra Technologies company.

Revision History

Changes to the original guide are listed below:

Change	Date	Description
-01 Rev A	08/30/2013	Initial release.
-02 Rev A	04/24/2014	Add RS507 support, Bluetooth pairing utility. Update PTT Express application.
-03 Rev A	02/10/2015	Zebra rebranding.

Contents

Copyrights.....	3
Revision History.....	5
About This Guide.....	11
Documentation Set.....	11
Configurations.....	11
Chapter Descriptions.....	12
Notational Conventions.....	12
Icon Conventions.....	12
Related Documents.....	13
Service Information.....	13
Chapter 1: Getting Started.....	15
Features.....	15
Unpacking.....	17
Setup.....	18
Installing the Battery.....	18
Charging the Battery.....	18
Powering On the MC40.....	19
Replacing the Battery.....	20
Battery Management.....	21
Setting the Date and Time.....	22
Display Setting.....	23
Setting the Screen Brightness.....	23
Setting Screen Rotation.....	23
Changing the Screen Timeout Setting.....	24
General Sounds Setting.....	24
Chapter 2: Using the MC40.....	27
Home Screen.....	27
Status Bar.....	28
Status Icons.....	28
Notification Icons.....	30
Managing Notifications.....	31
Application Shortcuts and Widgets.....	31
Adding an Application or Widget to the Home Screen.....	31
Moving Items on the Home Screen.....	32
Removing an App or Widget from the Home Screen.....	32
Folders.....	32
Creating Folders.....	32
Naming Folders.....	32
Removing a Folder.....	33
Home Screen Wallpaper.....	33
Change the Home Screen Wallpaper.....	33
Using the Touchscreen.....	33
Using the On-screen Keyboard.....	34
Applications.....	35
Accessing Applications.....	37
Switching Between Recent Applications.....	38
Un-Locking the Screen.....	38

Single User Mode.....	38
MultiUser Mode.....	40
MultiUser Login.....	40
MultiUser Logout.....	41
Resetting the Device.....	41
Performing a Soft Reset.....	41
Performing a Hard Reset.....	41
Suspend Mode.....	42
File Browser.....	42
PTT Express Voice Client.....	44
Enabling PTT Communication.....	45
Selecting a Talk Group.....	46
PTT Communication.....	46
Creating a Group Call.....	47
Responding to a Group Broadcast.....	47
Responding with a Private Response.....	47
Responding with a Private Response with the Wired Headset.....	48
Disabling PTT Express Voice Client Communication.....	48
VoIP Telephony Ready.....	48
Chapter 3: Data Capture.....	49
Imager.....	49
Digital Camera.....	49
RS507 Hands-Free Imager.....	50
Scanning Considerations.....	50
Bar Code Capture with Imager.....	51
Bar Code Capture with Integrated Camera.....	52
Bar Code Capture with RS507 Hands-Free Imager.....	52
Pairing the RS507 Hands-Free Imager Using SSI.....	54
Pairing the RS507 Hands-Free Imager Bluetooth HID.....	54
Reading Magnetic Stripe Cards.....	55
Improper Swiping.....	57
DataWedge.....	59
Enabling DataWedge.....	59
Disabling DataWedge.....	60
Chapter 4: WLAN.....	61
Scan and Connect to a Wi-Fi Network.....	61
Chapter 5: Bluetooth.....	63
Adaptive Frequency Hopping.....	63
Security.....	63
Bluetooth Profiles.....	64
Bluetooth Power States.....	64
Bluetooth Radio Power – Android.....	64
Enabling Bluetooth.....	65
Disabling Bluetooth.....	65
Discovering Bluetooth Device(s).....	65
Changing the Bluetooth Name.....	66
Connecting to a Bluetooth Device.....	66
Selecting Profiles on the Bluetooth Device.....	67
Disconnecting from a Bluetooth Device.....	67
Unpairing a Bluetooth Device.....	67

Chapter 6: Photos and Videos.....	69
Taking Photos.....	69
Taking a Panoramic Photo.....	70
Recording Videos.....	71
Camera Settings.....	72
Video Settings.....	72
Viewing Photos and Videos.....	73
Working with Albums.....	74
Share an Album.....	74
Get Album Information.....	74
Deleting an Album.....	75
Working with Photos.....	75
Viewing and Browsing Photos.....	75
Rotating a Photo.....	76
Cropping a Photo.....	76
Get Photo Information.....	77
Share a Photo.....	77
Deleting a Photo.....	77
Working with Videos.....	77
Watching Videos.....	77
Sharing a Video.....	78
Deleting a Video.....	78
Chapter 7: Accessories.....	79
MC40 Accessories.....	79
Micro USB Cable.....	80
Single Slot Charge Cradle.....	81
Five Slot Charge Only Cradle.....	82
Four Slot Battery Charger.....	84
Chapter 8: Maintenance and Troubleshooting.....	87
Maintaining the MC40.....	87
Battery Safety Guidelines.....	87
Cleaning Instructions.....	88
Cleaning the MC40.....	89
Connector Cleaning.....	89
Cleaning Cradle Connectors.....	89
Troubleshooting the MC40.....	90
Single-Slot Charge Cradle Troubleshooting.....	92
Five-Slot Charge Only Cradle CRDUNIV-40-5000R Troubleshooting.....	92
Four-Slot Battery Charger SACMC40XX-4000R Troubleshooting.....	93
Chapter 9: Technical Specifications.....	95
MC40 Technical Specifications.....	95
Single-Slot Charge Cradle CRDMC40XX-1000R Technical Specifications.....	98
Five-Slot Charge Only Cradle CRDUNIV-40-5000R Technical Specifications.....	98
Four-Slot Battery Charger SACMC40XX-4000R Technical Specifications.....	99

About This Guide

This guide provides information on using the MC40 and accessories.



Note: Screens and windows pictured in this guide are samples and can differ from actual screens.

Documentation Set

The documentation set for the MC40 provides information for specific user needs, and includes:

- *MC40 Quick Start Guide* - describes how to get the device up and running.
- *MC40 Regulatory Guide* - provides required regulatory information.
- *MC40 User Guide* - describes how to use the device.
- *MC40 Integrator Guide* - describes how to set up the device and accessories.

Configurations

This guide covers the following configurations:

Configuration	Radios	Display	Memory	Data Capture Options	Operating System
MC40	WLAN: 802.11a/b/g/n/r WPAN: Blue-tooth v2.1 with EDR	4.3" color WVGA	1 GB RAM / 8 GB Flash	camera and imager or camera, imager and MSR, optional RS507 Hands-free Imager	Android-based, Android Open-Source Project 4.1.1

Software Versions

To determine the current software versions touch  >  **About device**.

- **Serial number** – Displays the serial number.
- **Model number** – Displays the model number.
- **Android version** – Displays the operating system version.
- **Kernel version** – Displays the kernel version number.
- **Build number** – Displays the software build number.

The build number contains the software revision number and whether the MC40 is VoIP telephony ready.

Example Build Number: 0z-4AJ11-J-xxxx-xxxx-y0-M1-mmddy

- **z** = software version number
- **y** = VoIP telephone ready

where:

- **0** = not VoIP telephony ready
- **V** = VoIP telephony ready.
- **F** = FIPS & VoIP telephony ready.

Chapter Descriptions

Topics covered in this guide are as follows:

- *Getting Started on page 15* provides information on getting the MC40 up and running for the first time.
- *Using the MC40 on page 27* provides basic instructions for using the MC40, including powering on and resetting the MC40.
- *Data Capture on page 49* provides information for capturing bar code data using the internal camera and optional scan modules and Bluetooth scanner.
- *WLAN on page 61* provides information for configuring Wi-Fi.
- *Bluetooth on page 63* provides information for configuring Bluetooth.
- *Photos and Videos on page 69* explains how to take photos, capture videos and video images in the Gallery application.
- *Accessories on page 79* describes the available accessories and how to use them with the MC40.
- *Maintenance and Troubleshooting on page 87* includes instructions on cleaning and storing the MC40, and provides troubleshooting solutions for potential problems during MC40 operation.
- *Technical Specifications on page 95* provides the technical specifications for the MC40.

Notational Conventions

The following conventions are used in this document:

- *Italics* are used to highlight the following:
 - Chapters and sections in this and related documents
 - Icons on a screen.
- **Bold** text is used to highlight the following:
 - Dialog box, window, and screen names
 - Drop-down list and list box names
 - Check box and radio button names
 - Button names on a screen.
- Bullets (•) indicate:
 - Action items
 - Lists of alternatives
 - Lists of required steps that are not necessarily sequential
- Sequential lists (for example, lists that describe step-by-step procedures) appear as numbered lists.

Icon Conventions

The documentation set is designed to give the reader more visual clues. The following graphic icons are used throughout the documentation set. These icons and their associated meanings are described below.



Warning: The word WARNING with the associated safety icon implies information that, if disregarded, could result in death or serious injury, or serious product damage.



Caution: The word CAUTION with the associated safety icon implies information that, if disregarded, may result in minor or moderate injury, or serious product damage.



Note: NOTE contains information more important than the surrounding text, such as exceptions or preconditions. They also refer the reader elsewhere for additional information, remind the reader how to complete an action (when it is not part of the current procedure, for instance), or tell the reader where something is located on the screen. There is no warning level associated with a note.

Related Documents

- *MC40 Quick Start Guide*, p/n 72-166941-xx
- *MC40 Regulatory Guide*, p/n 72-166942-xx
- *MC40 Integrator Guide*, p/n 72E-166943-xx
- *RS507 Hands-free Imager Product Reference Guide*, p/n 72E-120802-xx

For the latest version of this guide and all guides, go to: <http://www.zebra.com/support>

Service Information

If you have a problem with your equipment, contact Zebra Support Center for your region. Contact information is available at: <http://www.zebra.com/support>.

When contacting the Zebra Support Center, please have the following information available:

- Serial number of the unit (found on manufacturing label)
- Model number or product name (found on manufacturing label)
- Software type and version number

Figure 1: Manufacturing Label Location

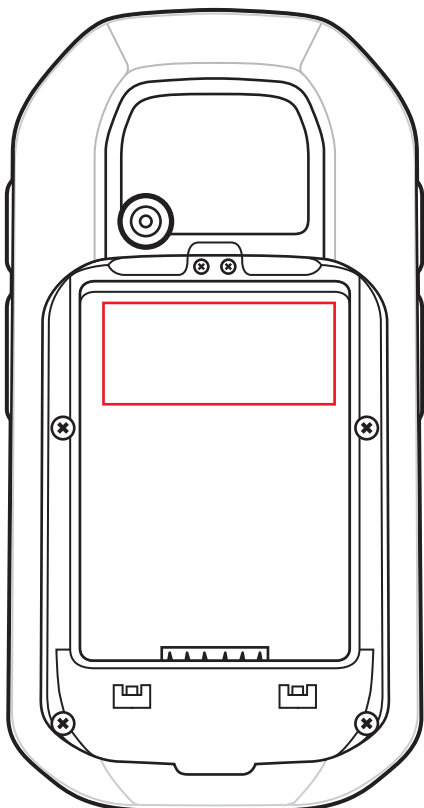

Zebra responds to calls by email or telephone within the time limits set forth in support agreements.

If your problem cannot be solved by the Zebra Support Center, you may need to return your equipment for servicing and will be given specific directions. Zebra is not responsible for any damages incurred during shipment if the approved shipping container is not used. Shipping the units improperly can possibly void the warranty.

If you purchased your product from a Zebra business partner, contact that business partner for support.

Chapter 1

Getting Started

This chapter provides the features of the MC40 and explains how to set it up for the first time.

Features

Figure 2: Front View

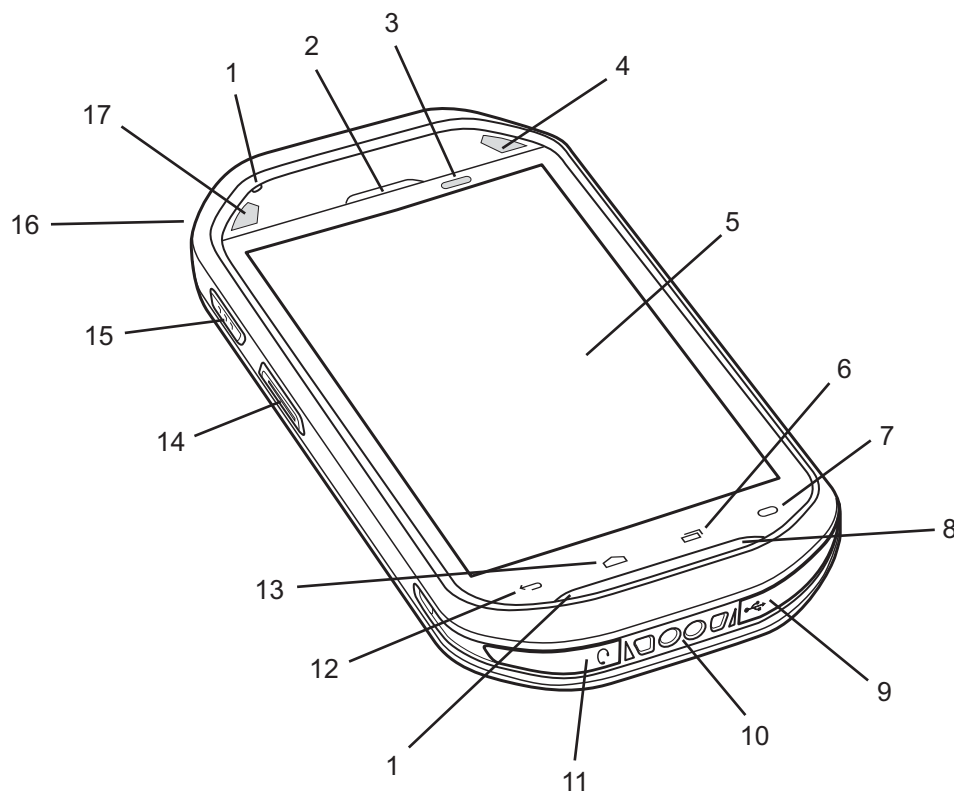

Table 1: Features - Front View

Number	Item	Function
1	Microphone	Use for making voice recordings.
2	Receiver	Provide audio in handset mode.
3	Light/Proximity Sensor	Determines ambient light for controlling display backlight intensity and for turning off display when in handset mode.

Table continued...





Number	Item	Function
4	Right LED	Indicates battery charge state when MC40 is in a charger. Indicates decode functionality. Lights green indicating a successful decode.
5	Touch Screen	Displays all information needed to operate the MC40.
6		Menu Button - Opens a menu with items that affect the current screen or application.
7		Search - Opens the Search window.
8	Speaker	Provides audio output for video and music playback.
9	USB Connector	Provides power to the device from cradles and cables and provides USB client and host communications.
10	Charging Contacts	Provides power to the MC40 from the cradles.
11	Headset Jack	Connects to mono headsets (3-wire, 2.5 mm plug).
12		Back Button — Displays the previous screen. Closes the keyboard if the on-screen keyboard is open.
13		Home Button — Displays the Home screen with a single touch. Displays recently used applications when held for a short period.
14	Left Scan/Action Button	Initiates scanning when a scan application is enabled (default). Programmable using Button Remap Program. See <i>MC40 Integrator Guide</i> for more information.
15	PTT Button	Initiates a Broadcast PTT call when PTT Express is active. Programmable using Button Remap Program. See <i>MC40 Integrator Guide</i> for more information.
16	Power Button	Press and hold to turn on the MC40. Press to turn on or off the screen. Press and hold to select one of these options: <ul style="list-style-type: none"> • Silent mode - The device is set to vibrate mode; all sounds are disabled except for alarms. • Airplane mode - Disable all wireless connections. • Disable Touch Keys - Disables or enables the four touch keys below the screen. • Battery swap - Place device in Battery Swap mode when replacing the battery. • Reset - Reboot the MC40 when software stops responding. • Power off - Turn off the MC40.
17	Left LED	Indicates decode functionality. Lights green indicating a successful decode.

Figure 3: Back View**Table 2: Features - Back View**

Number	Item	Function
18	Battery	Provides the MC40 with operating power.
19	Battery Latch	Secures the battery in position.
20	Camera	Takes photos, videos, and captures bar code data.
21	Right Scan/Action Button	Initiates scanning when a scan application is enabled (default). Programmable using Button Remap Program. See <i>MC40 Integrator Guide</i> for more information.
22	Volume Control	Increases and decrease audio volume. Programmable using Button Remap Program. See <i>MC40 Integrator Guide</i> for more information.
23	Imager	Captures bar code data.
24	MSR Slot (Optional)	Use to swipe magnetic stripe cards during credit or debit transactions.
25	Finger Strap Plug	Covers mounting area for optional Finger Strap.

Unpacking

Carefully remove all protective material from the MC40 and save the shipping container for later storage and shipping.

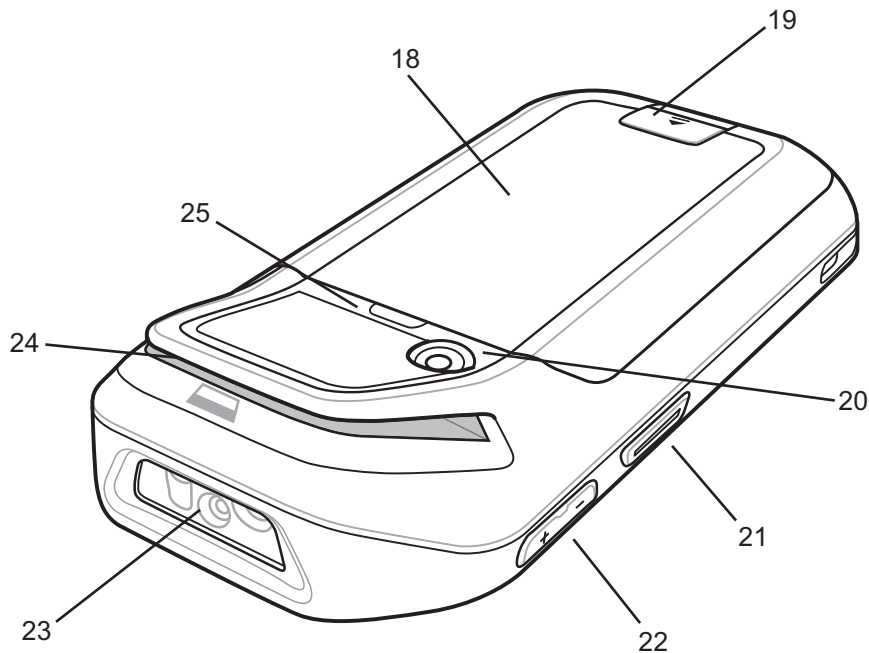
Verify the following items are in the box:

- MC40
- Lithium-ion battery
- Quick Start Guide
- Regulatory Guide.

Inspect the equipment for damage. If any equipment is missing or damaged, contact the Zebra Support Center immediately. See [Service Information on page 13](#) for contact information.

Setup

To start using the MC40 for the first time:

- Install the battery
- Charge the MC40
- Power on the MC40.

Installing the Battery

To install the battery:

Procedure:

- 1 Align the battery with the slots in the battery compartment.

Figure 4: Inserting the Battery

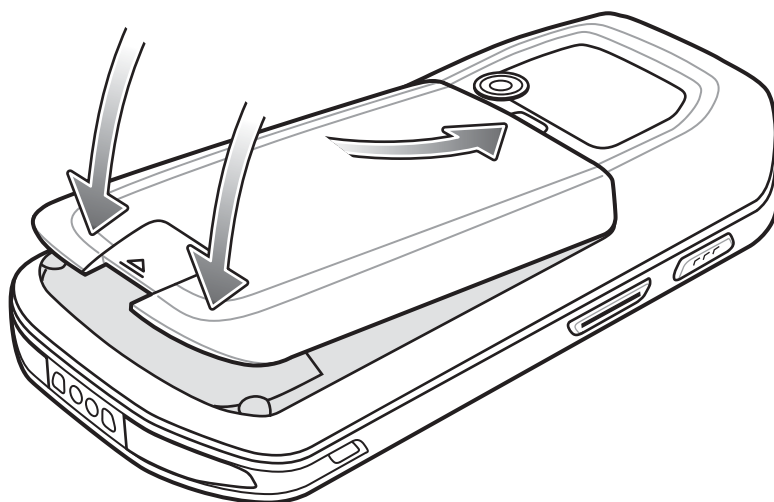

- 2 Lower the battery and press down until it snaps into place.
- 3 Press down on the battery latch.
- 4 Press the Power button to turn on the MC40.

Charging the Battery



Caution: Ensure that you follow the guidelines for battery safety described in [Battery Safety Guidelines on page 87](#).

Before using the MC40 for the first time, charge the main battery until the Right light emitting diode (LED) turns solid green (see [Table 3: Battery Charge LED Status on page 19](#) for charge status indications). To charge the MC40, use a cable or a cradle with the appropriate power supply. For information about the accessories available for the MC40, see [Accessories on page 79](#).

The MC40 is equipped with a memory backup battery that automatically charges from the fully-charged main battery. When using the MC40 for the first time, the backup battery requires approximately 36 hours to fully charge. This is also true any time the backup battery is discharged, which occurs when the main battery is removed for several hours. The backup battery retains random access memory (RAM) data in memory for at least 10 minutes (at room temperature) when the MC40's main battery is removed, when Battery Swap feature is used. When the MC40 reaches

a very low battery state, the combination of main battery and backup battery retains RAM data in memory for at least 48 hours.



For cable and cradle setup and charging procedures refer to the MC40 Integrator Guide.

- Micro USB Cable
- Single Slot Charging Cradle
- Five Slot Charge Only Cradle.

Table 3: Battery Charge LED Status

Status	Indications
Off	MC40 is not charging. MC40 is not inserted correctly in the cradle. MC40 is not connected to a power source. Charger or cradle is not powered.
Slow Blinking Amber (3 blinks every 2 seconds)	MC40 is charging.
Solid Green	Charging complete.
Fast Blinking Amber (3 blinks/second)	Charging error, e.g.: <ul style="list-style-type: none"> • Temperature is too low or too high. • Charging has gone on too long without completion (typically eight hours).
Flashes Amber once (when Power button pressed)	Critical battery state. Battery too low to boot device.
Fast Blinking Amber (when Power button pressed)	Battery over-temperature condition. Device shuts down. Battery will not charge until temperature returns to normal operating value.

Charging Temperature

Charge batteries in ambient temperatures from 0 °C to 40 °C (32 °F to 104 °F) or up to 45 °C (113 °F) as reported by the battery. To view the battery temperature, touch  >  **About device** > **Battery Information**.

Note that charging is intelligently controlled by the MC40. To accomplish this, for small periods of time, the MC40 or accessory alternately enables and disables battery charging to keep the battery at acceptable temperatures. The MC40 or accessory indicates when charging is disabled due to abnormal temperatures via its LED.

Charging Spare Batteries

See [Accessories on page 79](#) for information on using accessories to charge spare batteries.

Powering On the MC40

If the MC40 did not turn on when the battery was installed, press the Power button until the Right and Left LEDs flash once. The splash screen displays for about a minute as the MC40 initializes its flash file system. Note that these windows also appear upon reset.

Replacing the Battery



Note: Ensure that the Battery Swap mode procedures are followed, otherwise the backup battery will deplete quickly.

Procedure:

- 1 Press the Power button until the menu displays.
- 2 Touch **Battery swap**. The Right and Left LEDs light red.
- 3 Wait until the LEDs turns off.
- 4 Lift the battery latch.

Figure 5: Lift Battery Latch

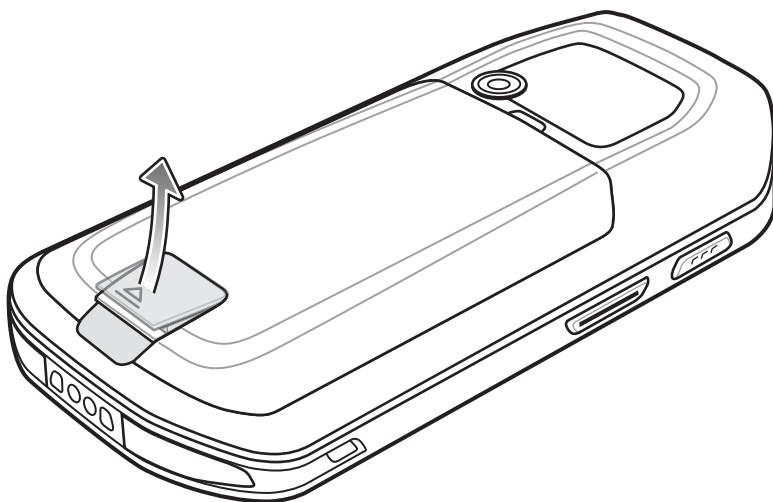

- 5 Remove the battery out of the battery compartment.

Figure 6: Remove Battery

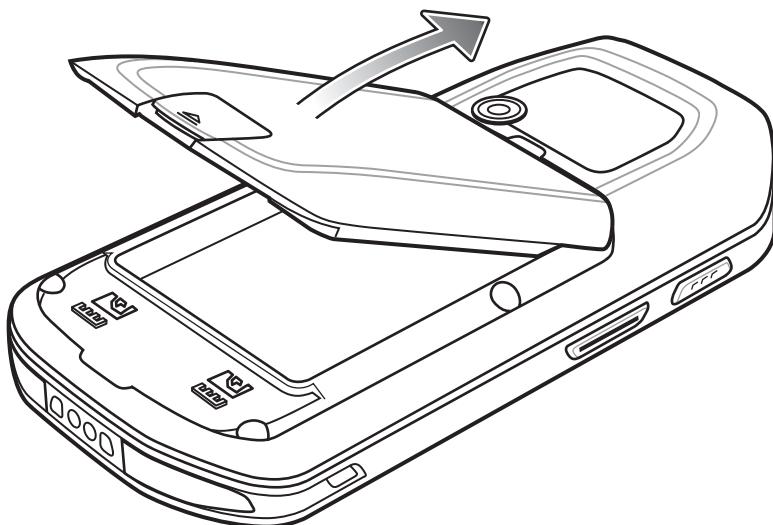

- 6 Align the replacement battery in the battery compartment.
- 7 Lower the battery and press down until it snaps into place.
- 8 Press down on the battery latch.
- 9 Press the Power button to turn on the MC40.

Battery Management



Note:

Prior to checking the battery charge level, remove the MC40 from any AC power source (cradle or cable).

To check the charge status of the main battery, touch  >  **About device** > **Status**.

Battery status indicates that the battery is discharging and **Battery level** lists the battery charge (as a percentage of fully charged).

Monitor Battery Usage

The Battery Use screen lists which applications consume the most battery power. Also use it to turn off applications that were downloaded if they are consuming too much power.

Touch  >  **Battery**.

Figure 7: Battery Use Screen

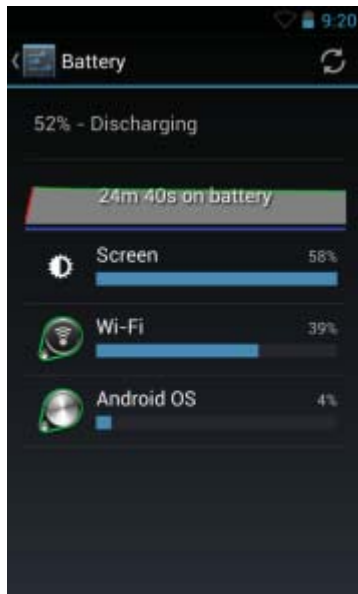

The Battery Use screen lists the applications using the battery. The discharge graph at the top of the screen shows the rate of battery discharge since last charged (short periods of time when connected to a charger are shown as thin green lines at the bottom of the chart), and how long it has been running on battery power.

Touch an application in the Battery Use screen to display details about its power consumption. Different applications display different information. Some applications include buttons that open screens with settings to adjust power use.

Low Battery Notification

When the battery charge drops below 20%, the MC40 sounds an alert and displays a notice to connect the MC40 to power.

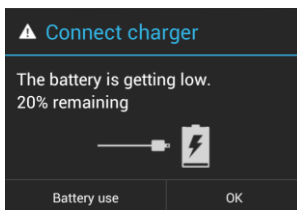
Figure 8: Low Battery Notification Screen

The user should replace the battery or charge the MC40 using one of the charging accessories.

When the battery charge drops below 15%, the MC40 sounds an alert and displays a notice to connect the MC40 to power.

When the battery charge drops below 12%, the MC40 sounds an alert and screen turns off. The Right and Left LEDs light red while goes into critical suspend mode to save data. Once it reaches critical suspend the Right and Left LEDs turn off.

The user must replace the battery or charge the MC40 using one of the charging accessories to retain data.

Battery Optimization



Observe the following battery saving tips:

- Leave the MC40 connected to AC power at all times when not in use.
- Set the screen to turn off after a short period of non-use.
- Reduce the screen brightness.
- Turn off all wireless radios when not in use.
- Turn off automatic syncing for Email, Calendar, Contacts, and other applications.
- Use the Power Control widget to check and control the status of radios, the screen brightness, and syncing.
- Minimize use of applications that keep the MC40 from suspending, for example, music and video applications.

Setting the Date and Time

The date and time is automatically synchronized using an NTP server when the MC40 is connected to a wireless network. The user is only required to set the time zone or set the date and time when not connected to a wireless network.

Procedure:

- 1 Touch .
- 2 Touch  **Date & time**.
- 3 Touch **Automatic date & time** to disable automatic date and time synchronization.
- 4 Touch **Automatic time zone** to disable automatic time zone synchronization.
- 5 Touch **Set date**.
- 6 Move the sliders up and down to select the month, date and year.
- 7 Touch **Done**.
- 8 Touch **Set time**.
- 9 Move the sliders up and down to select the hour, minutes and part of the day.
- 10 Touch **Done**.
- 11 Touch **Select time zone**.
- 12 Select the current time zone from the list.

13 Touch .

Display Setting

Use Display settings to change the screen brightness, change the background image, enable screen rotation, set sleep time and change font size.

Setting the Screen Brightness

Procedure:





- 1 Touch .
- 2 Touch  **Display**.
- 3 Touch **Brightness**.

Figure 9: Brightness Dialog Box



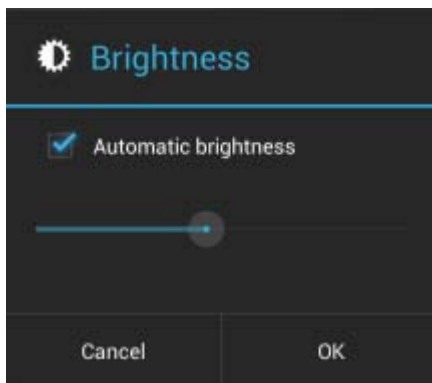

- 4 In the **Brightness** dialog box, check the **Automatic brightness** checkbox to set the device to automatically adjust the brightness using the built-in light sensor. Uncheck the checkbox to set the brightness manually. Use the slider to set a brightness level.
- 5 Use the slider to set a brightness level.
- 6 Touch **OK**.
- 7 Touch .

Setting Screen Rotation

The user can set the MC40 screen to rotate 90 degrees left or right.



Procedure:

- 1 Touch .
- 2 Touch  **Display**.
- 3 In the **Display settings** screen, check **Auto-rotate screen** to set the MC40 to automatically switch orientation when the MC40 is rotated.
- 4 Touch .

Changing the Screen Timeout Setting

To set the MC40 to turn off after a short period of non-use:

Procedure:

- 1 Touch .
- 2 Touch  **Display**
- 3 Touch **Sleep**
- 4 Select a value from the **Sleep** window. Options:
 - **15 seconds**
 - **30 seconds**
 - **1 minute** (default)
 - **2 minutes**
 - **5 minutes**
 - **10 minutes**
 - **30 minutes**
- 5 Touch .

General Sounds Setting

Use the **Sounds** settings to configure media and alarm volumes. Touch  >  **Sounds**.

Figure 10: Sounds Screen



- **Volumes** - Use to change the volume of media, ringtones and notifications and alarms.

Figure 11: Volumes Dialog Box

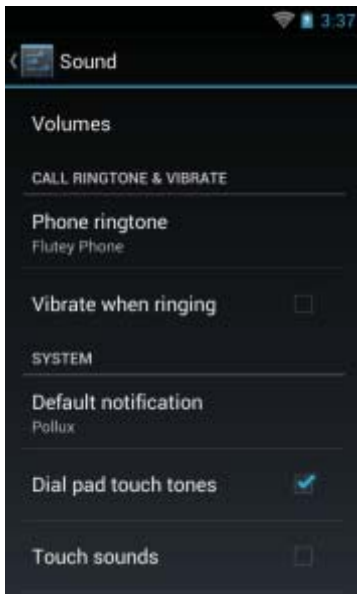
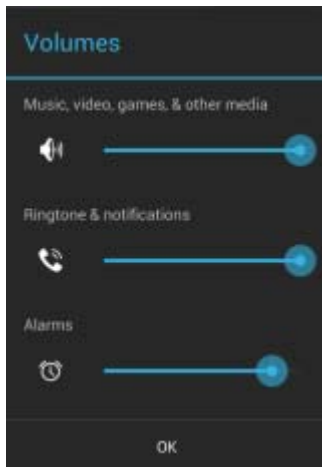
- **Call Ringtone and Vibrate**
 - **Phone ringtone** - Opens a dialog box to select the ringtone to sound when a VoIP call is received (VoIP telephony ready only).
 - **Vibrate when ringing** - Check to make the device vibrate when a call is received (VoIP telephony ready only).
- **System**
 - **Default notification** - Touch to select a sound to play for all system notifications.
 - **Touch sounds** - Check to play a sound when making screen selection.
 - **Screen lock sounds** - Check to play a sound when locking and unlocking the screen.
 - **Vibrate on touch** - Check to have the device vibrate when touching soft keys and on certain screen interactions.

Chapter 2

Using the MC40

This chapter describes the screens, status and notification icons, and controls on the MC40, and provides basic instructions for using the MC40.

Home Screen

The Home screen displays when the MC40 turns on. Depending upon the configuration, the Home screen might appear different. Contact your system administrator for more information.

After a suspend or screen time-out, the Home screen displays with the lock sliders. Slide  to the right toward  to unlock the screen. For screen locking information see [Un-Locking the Screen on page 38](#).

Figure 12: Home Screen



The Home screen consists of the following:

Table 4: Home Screen Items

Item	Description
1 — Status Bar	Displays the time, status icons (right side), and notification icons (left side). For more information see <i>Status Icons on page 28</i> and <i>Managing Notifications on page 31</i> .
2 — Browser Icon	Opens the Browser application.
3 — All Apps Icon	Opens the APPS window.
4 — Settings Icon	Opens the Settings window.
5 — Shortcut Icons	Opens applications installed on the MC40. See <i>Application Shortcuts and Widgets on page 31</i> for more information.
6 — Widgets	Launches stand-alone applications that run on the Home screen. See <i>Application Shortcuts and Widgets on page 31</i> for more information.

The Home screen provides four additional screens for placement of widgets and shortcuts. Swipe the screen left or right to view the additional screens.

Status Bar

The Status bar displays the time, notification icons (left side) and status icons (right side).

Figure 13: Notification and Status Icons

1	Notifications icons
2	Status icons

If there are more notifications than can fit in the Status bar,  displays indicating that more notifications exist. Open the Notifications panel to view all notifications and status.

Status Icons

Table 5: Status Icons







































Icon	Description
	Indicates that Bluetooth is on.
	Indicates that the device is connected to another Bluetooth device.

Table continued...

Icon	Description
	Indicates that the Alarm is active.
	Indicates that all sounds except media and alarms are silenced and vibrate mode is active.
	Indicates that the audio is silenced.
	Connected to a Wi-Fi network. Excellent signal strength.
	Connected to a Wi-Fi network. Good signal strength.
	Connected to a Wi-Fi network. Fair signal strength.
	Connected to a Wi-Fi network. Poor signal strength.
	No Wi-Fi signal.
	Indicates that the battery charge is very low.
	Indicates that the battery charge is low.
	Indicates that the battery is partially drained.
	Indicates that the battery is fully charged.
	Indicates that the battery is charging.
	Indicates that the MC40 is calculating the battery capacity level.
	Indicates an unknown charging error.
	Indicates that the battery temperature is nearing the high for charging to occur.
	Indicates that the battery temperature is nearing the low for charging to occur.
	Indicates that the Airplane Mode is active. All radios are turned off.
	Indicates that a wired headset is connected to the MC40.

Notification Icons

Table 6: Notification Icons

Icon	Description
	Indicates that more notifications are available for viewing.
	Indicates that data is syncing.
	Indicates an upcoming event.
	Indicates that an open Wi-Fi network is available.
	Indicates that a song is playing.
	Indicates that a problem with sign-in or sync has occurred.
	Indicates that the device is uploading data.
	Indicates that the Internal Storage is almost full.
	Indicates that the device is downloading data when animated and download is complete when static.
	Indicates that the device is connected via USB cable.
	Indicates that the device is connected to a virtual private network (VPN).
	Preparing Internal Storage.
	Indicates that USB debugging is enabled on the device.
	Screenshot captured.
	Error capturing screenshot.
	Indicates that the MultiUser feature is enabled.
	Indicates that a new user is logging in.
	Indicates the status of the PTT Express Voice Client.

Managing Notifications

Notification icons report the arrival of new messages, calendar events, and alarms, as well as ongoing events. When a notification occurs, an icon appears in the Status bar with a brief description. See [Notification Icons on page 30](#) for a list of possible notification icons and their description. Open the **Notifications** panel to view a list of all the notifications.

To open the Notification panel, drag the Status bar down from the top of the screen.

Figure 14: Notification Panel

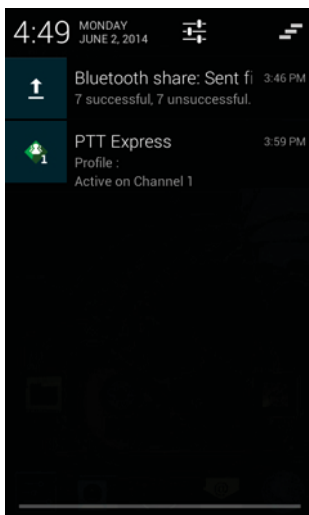

To respond to a notification, open the Notifications Panel and then touch a notification. The Notifications Panel closes and the subsequent activity is dependent on the notification.

To clear all notifications, open the Notifications Panel and then touch . All event-based notifications are removed. Ongoing notifications remain in the list.

To close the Notification Panel, drag the bottom of the Notifications Panel to the top of the screen or touch .

Application Shortcuts and Widgets

Application shortcuts placed on the Home screen allow quick and easy access to applications. Widgets are self-contained applications placed on the Home screen to access frequently used features.

Adding an Application or Widget to the Home Screen

Procedure:

- 1 Go to the desired Home screen.
- 2 Touch .
- 3 Swipe right, if necessary, to find the application icon or widget.
- 4 Touch and hold the icon or widget until the Home screen appears.
- 5 Position the icon on the screen and then release.

Moving Items on the Home Screen

Procedure:

- 1 Touch and hold the item until it floats on the screen.
- 2 Drag the item to a new location. Pause at the edge of the screen to drag the item onto an adjacent Home screen.
- 3 Lift finger to place the item on the Home screen.

Removing an App or Widget from the Home Screen

Procedure:

- 1 Go to the desired Home screen.
- 2 Touch and hold the application shortcut or widget icon until it floats on the screen.
- 3 Drag the icon to  **Remove** on the top of the screen and then release.

Folders

Use **Folders** to organize similar applications together. Tap the folder to open and display items in the folder.

Creating Folders

Procedure:

- 1 Go to the desired Home screen.
- 2 Place at least two application shortcuts on the Home screen.
- 3 Touch and hold a shortcut until it floats on the screen.
- 4 Move the icon over another icon. A blue circle appears around the icons.

Figure 15: Stacked Shortcut Icons



- 5 Lift finger to stack the icons. The shortcut icons appear over a black circle.

Figure 16: Unnamed Folder



Naming Folders

Procedure:

- 1 Touch the folder.

Figure 17: Open Folder

- 2 Touch the title area and enter a folder name using the keyboard.
- 3 Touch **Done**.
- 4 Touch anywhere on the Home screen to close the folder. The folder name appears under the folder.

Figure 18: Renamed Folder

Removing a Folder

Procedure:

- 1 Touch and hold the folder icon until it enlarges and the device vibrates.
- 2 Drag the icon to **X Remove** and release.

Home Screen Wallpaper



Note: Use of Live Wallpaper may reduce battery life.

Change the Home Screen Wallpaper

Procedure:

- 1 Touch and hold on the Home screen until the **Choose Wallpaper from** menu appears.
- 2 Touch **Gallery**, **Live wallpapers** or **Wallpapers**.
 - **Gallery** - Select to use an image stored on the device.
 - **Live wallpapers** - Select to use an animated wallpaper image.
 - **Wallpapers** - Select to use a wallpaper image.
- 3 Touch **Save** or **Set wallpaper**.



Using the Touchscreen

Use the dual-touch sensitive screen to operate the device.

- **Touch** - Touch to:
 - select items on the screen
 - type letters and symbols using the on-screen keyboard
 - press on-screen buttons.

- **Touch and Hold** - Touch and hold:
 - an item on the Home screen to move it to a new location or to the trash.
 - an item in the **All Apps** screen to create a shortcut on the Home screen.
 - the Home screen to change the Home screen wallpaper.
- **Drag** - Touch and hold an item for a moment and then move finger on the screen until reaching the new position.
- **Swipe** - Move finger up and down or left and right on the screen to:
 - unlock the screen
 - view additional Home screens
 - view additional application icons in the **All Apps** screen
 - view more information on an application's screen.
- **Double-tap** - Tap twice on a web page, map, or other screen to zoom in and out.
- **Pinch** - In some applications, zoom in and out by placing two fingers on the screen and pinching them together (to zoom out) or spreading them apart (to zoom in).

Using the On-screen Keyboard



Use the on-screen keyboard to enter text in a text field. To configure the keyboard settings, touch  (comma) >  and then select **Android keyboard settings**.

Editing Text

Edit entered text and use menu commands to cut, copy, and paste text within or across applications. Some applications do not support editing some or all of the text they display; others may offer their own way to select text.

Entering Numbers, Symbols and Special Characters

To enter numbers and symbols:

- Touch and hold one of the top-row keys until a menu appears then select a number. Keys with alternate characters display an ellipsis (...) below the character.
- Touch and hold the Shift key with one finger, touch one or more capital letters or symbols to enter them, and then lift both fingers to return to the lowercase keyboard.
- Touch  to switch to the numbers and symbols keyboard.
- Touch the  key on the numbers and symbols keyboard to view additional symbols.

To enter special characters, touch and hold a number or symbol key to open a menu of additional symbols.

- A larger version of the key displays briefly over the keyboard.
- Keys with alternate characters display an ellipsis (...) below the character.

Applications

The **All Apps** screen displays icons for all installed applications. *Table 7: Applications on page 35* lists the applications available on the MC40. Refer to the *MC40 Integrator Guide* for information on installing and uninstalling application.

Table 7: Applications

















Icon	Description
	Bluetooth Pairing Utility – Use to pair Bluetooth devices with the MC40 by scanning a bar code.
	Browser - Use to access the Internet or intranet.
	Calculator - Provides the basic and scientific arithmetic functions.
	Calendar - Use to manage events and appointments.
	Camera - Take photos or record videos. For more information see <i>Photos and Videos on page 69</i> .
	Card Swipe Tutorial - Use to practice swiping a magnetic stripe card through the MSR on devices with an MSR slot.
	Clock - Use to schedule alarms for appointments or as a wake-up.
	DataWedge - Enables data capture using the camera or optional scanner.
	Device-Config - Use to configure multiple MC40 devices. See the <i>MC40 Integrator Guide</i> for more information.
	Downloads - Lists all downloads files.

Table continued...

Icon	Description
	DWDemo - Provides a way to demonstrate the data capture features using the Camera, Scanning Module or Magnetic Stripe Reader.
	Email - Use to send and receive email.
	File Browser - Organize and manage files on the device. See <i>File Browser on page 42</i> for more information.
	Gallery - Use to view photos stored in Internal Storage. See <i>Viewing Photos and Videos on page 73</i> for more information.
	MLog Manager – Use to capture log files for diagnostics. See <i>MC40 Integrator Guide</i> for more information.
	MSP Agent - Enables management of the device from an MSP server. Requires the purchase of an appropriate MSP client license per device to suit the level of management functionality required.
	Music - Play music stored in Internal Storage.
	People - Use to manage contact information.
	Phone - use to dial a phone number when used with some VoIP clients (VoIP telephony ready only).
	PTT Express - Use to launch the PTT Express client for Voice over IP (VoIP) communication.
	Rapid Deployment - Allows the device to stage a device for initial use by initiating the deployment of settings, firmware and software. Requires the purchase of an MSP client license per device.
	RxLogger – Use to diagnose device and application issues. See <i>MC40 Integrator Guide</i> for more information.
	Search - Use the Google search engine to search the Internet and the device.

Table continued...

Icon	Description
	Settings - Use to configure the device. For more information, refer to the <i>MC40 Enterprise Tablet Integrator Guide</i> .
	Sound Recorder - Use to record audio.
	TecDocs - Displays the On-device User Guide.
	AppLock Administrator - Use to configure the Application Lock feature. This icon appears after the optional application is installed.
	MultiUser Administrator - Use to configure the MultiUser feature. This icon appears after the optional application is installed.
	Secure Storage Administrator - Use to configure the Secure Storage feature. This icon appears after the optional application is installed.

Accessing Applications

All applications installed on the device are accessed using the **APPS** window.

Procedure:

- 1 On the Home screen touch . The **APPS** window displays.

Figure 19: APPS Window



- 2 Slide the **APPS** window left or right to view more application icons. Touch an icon to open the application.



Note: See *Application Shortcuts and Widgets on page 31* for information on creating a shortcut on the Home screen.

Switching Between Recent Applications

Procedure:

- 1 Touch and hold A window appears on the screen with icons of recently used applications.

Figure 20: Recently Used Applications



- 2 Slide the window up and down to view all recently used applications.
- 3 Swipe left or right to remove application from the list and force close the application.
- 4 Touch an icon to open it or touch to return to the current screen.

Un-Locking the Screen

Use the Lock screen to protect access to data on the MC40. Some email account require locking the screen. Refer to the *MC40 Integrator Guide* for information on setting up the locking feature. The Locking feature functions differently in Single User mode or Multiple User mode.

Single User Mode

When locked, a pattern, PIN or password is required to unlock the device. Press the Power button to lock the screen. The device also locks after a pre-defined time-out.

Press and release the Power button to wake the device.

The Lock screen displays. Slide up to unlock the screen. If the Pattern screen unlock feature is enabled, the Pattern screen appears instead of the Lock screen.

If the PIN or Password screen unlock feature is enabled, enter the PIN or password after unlocking the screen.

Figure 21: Lock Screen**Figure 22: PIN Screen**

Figure 23: Pattern Screen**Figure 24: Password Screen**

MultiUser Mode

With MultiUser login, multiple users can log on to the device with each user having access to various applications and features. When enabled, the Login screen appears after powering on, resetting or after the device wakes from suspend mode.

MultiUser Login

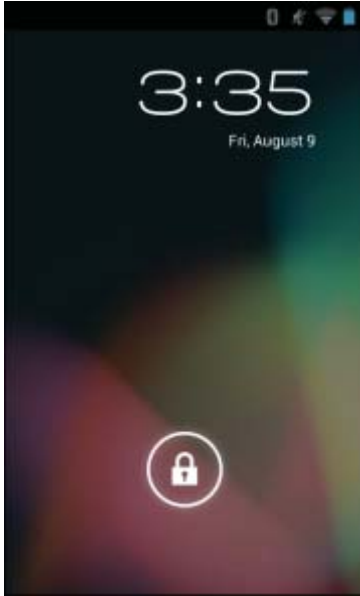
Procedure:

- 1 In the **Login** text field, enter the username.

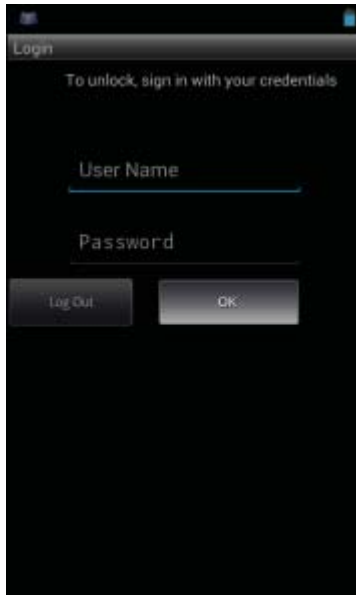
Figure 25: Multiple User Log In Screen

- 2 In the **Password** text field, enter the password.
- 3 Touch **OK**. After a resume from suspend, the user must enter the password.

MultiUser Logout

Procedure:

- 1 Drag the Status Bar down from the top of the screen.
- 2 Touch **MultiUser is active**.
- 3 Touch **Logout**.
- 4 The **Login** screen appears.

Resetting the Device

There are two reset functions, soft reset and hard reset.

Performing a Soft Reset

Perform a soft reset if applications stop responding.

Procedure:

- 1 Press and hold the Power button until the menu appears.
- 2 Touch **Reset**.
- 3 The device shuts down and then reboots.
- 4 The device reboots.

Performing a Hard Reset

Perform a Hard Reset if the device stops responding. To perform a Hard Reset:

Procedure:



- 1 Simultaneously press the Power, Left Scan/Action and Up Volume buttons.

- 2 The device shuts down and then reboots.

Suspend Mode

The MC40 goes into suspend mode when the user presses the Power button or after a period of inactivity (set in the Display settings window).

To wake the MC40 from Suspend mode, press the Power button.

The Lock screen displays. Slide  to the right toward  to unlock the screen. If the Pattern screen unlock feature is enabled, the Pattern screen appears instead of the Lock screen. See [Un-Locking the Screen on page 38](#).



Note:

If the user enters the PIN, password or pattern incorrectly five times, they must wait 30 seconds before trying again.

If the user forgets the PIN, password or pattern contact the system administrator.

Figure 26: Lock Screen

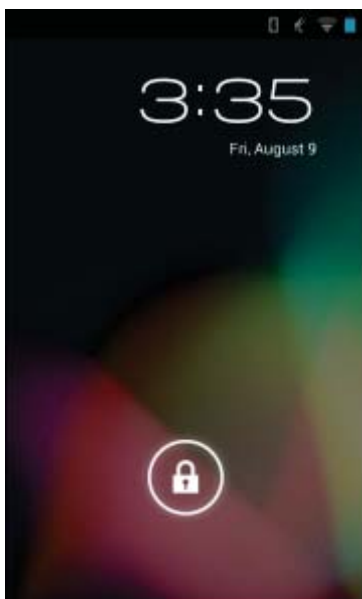

File Browser

Use the **File Browser** application to view and manage files on the device.

To open **File Browser**, touch  > .

Figure 27: File Browser Screen



The address bar (1) indicates the current folder path. Touch the current folder path to manually enter a path and folder name.

Use  (2) to select multiple files/folder.

Use  (3) to view the internal storage root folder.







Use  (4) to view the microSD card root folder.

Use  (5) to view the previous folder or to exit the application.

Touch and hold an item to perform an operation on that item. Select one of the options from the **File Operations** menu:

- **Information** - View detailed information about the file or folder.
- **Move** - Move the file or folder to a new location.
- **Copy** - Copy the select file.
- **Delete** - Delete the selected file.
- **Rename** - Rename the select file.
- **Open as** - Open the selected file as a specific file type.
- **Share** - Share the file with other devices.

Touch  to open additional functionality:

- Touch  > **New Folder** to create a new folder in the current folder.
- Touch  > **Search** to search for a file or folder.
- Touch  > **Sort** to sort the list by name, by type, by size or by date.
- Touch  > **Refresh** to re-display the contents of the current folder.
- Touch  > **List View** to change the folder view from tile to list format.
- Touch  > **Change Size** to change the size of the icons: Large, Normal or Small.

- Touch  > **About File Browser** to view the application version information.

PTT Express Voice Client



Note:

PTT Express Voice Client creates Push-To-Talk (PTT) communication capability between disparate enterprise devices. Leveraging existing Wireless Local Area Network (WLAN) infrastructure, PTT Express delivers simple PTT communication without the need of a voice communication server.

- **Group Call:** Press and hold the PTT (Talk) button to start communicating with other voice client users.
- **Private Response:** Press and hold the Left Scan/Action (Private) button to respond to the originator of the last broadcast or to make a Private Response.

PTT Audible Indicators

The following tones provide helpful cues when using the voice client.

- **Talk Tone:** Double chirp. Plays when the Talk (or Private) button is depressed. This is a prompt for the user to start talking.
- **Access Tone:** Single beep. Plays when another user just finished a broadcast or response. The user is now able to initiate a Group Broadcast or Private Response.
- **Busy Tone:** Continuous tone. Plays when the Talk (or Private) button is depressed and another user is already communicating on the same talkgroup. Plays after the maximum allowed talk time is reached (60 seconds).
- **Network Tone:**
 - Three increasing pitch beeps. Plays when PTT Express has acquired the WLAN connection and the service is enabled.
 - Three decreasing pitch beeps. Plays when PTT Express has lost the WLAN connection or the service is disabled.

Figure 28: PTT Express Default User Interface



Table 8: PTT Express Default user Interface Descriptions

Item	Description
Notification Icon	Indicates the current state of the PTT Express client.
Service Indication	Indicates the status of the PTT Express client. Options: Service Enabled , Service Disabled or Service Unavailable .







Table continued...

Item	Description
Talk Groups	Lists all 32 Talk Groups available for PTT communication.
Settings	Opens the PTT Express Settings screen.
Enable/Disable Switch	Turns the PTT service on and off.

Notification Icons

Indicates the current state of the PTT Express Voice client.

Table 9: PTT Express Default User Interface Descriptions

Status Icon	Description
	Indicates that PTT Express Voice client is disabled.
	Indicates that PTT Express Voice client is enabled but not connected to a WLAN.
	Indicates that PTT Express Voice client is enabled, connected to a WLAN and listening on the Talk Group indicated by the number next to the icon.
	Indicates that PTT Express Voice client is enabled, connected to a WLAN and communicating on the Talk Group indicated by the number next to the icon.
	Indicates that PTT Express Voice client is enabled, connected to a WLAN and in a private response.
	Indicates that PTT Express Voice client is enabled and muted.
	Indicates that the PTT Express Voice client is enabled but it is not able to communicate due to a VoIP telephony call is in progress.

Enabling PTT Communication

Procedure:

- 1 Touch .
- 2 Touch .
- 3 Slide the **Enable/Disable Switch** to the **ON** position. The button changes to an **ON** button.

Figure 29: PTT Express Window

Selecting a Talk Group

One of 32 Talk Groups can be selected by PTT Express users. However, only one talk group may be enabled at a time on the device. Touch one of the 32 Talk Groups. The selected Talk Group is highlighted.

PTT Communication



Note: This section describes the default PTT Express client configuration. See the *PTT Express V1.2 User Guide* for detailed information on using the client.

PTT communication may be established as a Group Call or Private Response. When PTT Express is enabled, the buttons on the left side of the device are assigned for PTT communication. When the Wired Headset is used, Group Calls and Private Responses can also be initiated using the headset Talk button.

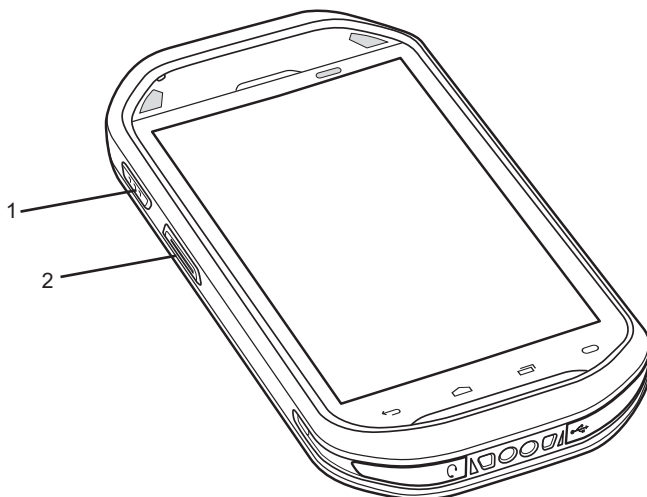
Figure 30: MC40 PTT Buttons

1	Group Call Hard Button
2	Private Call Hard Button

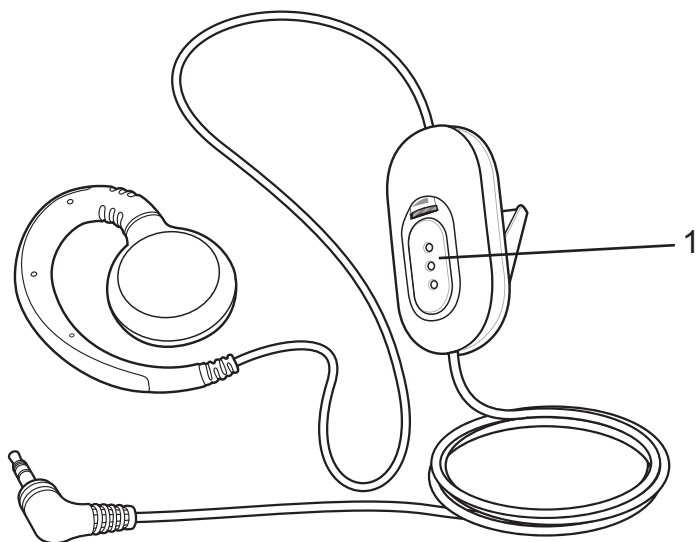
Figure 31: Wired Headset

1	Talk Button
---	-------------

Creating a Group Call

Procedure:

- 1 Press and hold the Group Call button (or the Talk button on the headset) and listen for the talk tone to play. If a busy tone is heard, release the button and wait a moment before making another attempt. Ensure that PTT Express and the WLAN are enabled.
- 2 Start talking after the talk tone is heard.



Note: If the user holds the button for more than 60 seconds (default), the call is dropped allowing others to make Group calls. The user should release the button when finished talking to allow others to make calls.

- 3 Release the button when finished talking.

Responding to a Group Broadcast

Procedure:

- 1 Wait until an access tone is heard.
- 2 Press and hold the Talk button, and listen for the talk tone to play. If a busy tone is heard, release the Talk button and wait a moment before making another attempt. Ensure that PTT Express and the WLAN are enabled.
- 3 Start talking after the talk tone plays.
- 4 Release the Talk button when finished talking.

Responding with a Private Response

The Private Response can only be initiated once a Group Call has been established. The initial Private Response is made to the originator of the Group Call.

Procedure:

- 1 Wait until an access tone is heard.
- 2 Within 10 seconds, press and hold the Private Response Hard Button, and listen for the talk tone to play.

If a busy tone is heard, release the button and wait a moment before making another attempt. Ensure that PTT Express and the WLAN are enabled.

- 3 Start talking after the talk tone plays.
- 4 Release the button when finished talking.

Responding with a Private Response with the Wired Headset

The Private Call can only be initiated once a Group Call has been established. The initial Private Response is made to the originator of the Group Call.

Procedure:

- 1 Wait until an access tone is heard.
- 2 Within 10 seconds, press and release and then press and hold the Talk button, and listen for the talk tone to play.
If a busy tone is heard, release the button and wait a moment before making another attempt. Ensure that PTT Express and the WLAN are enabled.
- 3 Start talking after the talk tone plays.
- 4 Release the button when finished talking.

Disabling PTT Express Voice Client Communication

Procedure:

- 1 Touch .
- 2 Touch .
- 3 Slide the **Enable/Diable Switch** to the **OFF** position. The button changes to **OFF**.
- 4 Touch .

VoIP Telephony Ready

The MC40 VoIP telephony-ready models are optimized to support telephony VoIP functionality.

Use the Zebra Mobile Extensions Client or other 3rd party clients are required. Refer to the documentation provided with the client software for installation and usage information.

Chapter

3

Data Capture

The MC40 offers the following data capture options:

- integrated imager
- integrated digital camera
- Magnetic stripe reader (MSR)
- RS507 Hands-free imager.



Note:

By default, the good decode beep is set to system volume (Music and Media). The good decode beep can be set to another sound (Notifications or Alarms) and the volume can be independently controlled. See the *DataWedge* section in the *MC40 Integrator Guide* for more information.

DataWedge is installed and enabled on the MC40 by default.

Imager

The device with an integrated imager has the following features:

- Omnidirectional reading of a variety of bar code symbologies, including the most popular linear, postal, PDF417, and 2D matrix code types.
- Advanced intuitive laser aiming cross-hair for easy point-and-shoot operation.

The module uses digital camera technology to take a digital picture of a bar code, stores the resulting image in its memory, and executes state-of-the-art software decoding algorithms to extract the data from the image.

Operational Modes

The device with an integrated imager supports two modes of operation, listed below. Activate each mode by pressing a scan button.

- **Decode Mode:** In this mode, the device attempts to locate and decode enabled bar codes within its field of view. The imager remains in this mode as long as the user holds the scan button, or until it decodes a bar code.



Note: To enable Pick List Mode, configure in DataWedge.

- **Pick List Mode:** This mode allows the user to selectively decode a bar code when more than one bar code is in the device's field of view. To accomplish this, move the aiming crosshair over the required bar code to decode only this bar code. This feature is ideal for pick lists containing multiple bar codes and manufacturing or transport labels containing more than one bar code type (either 1D or 2D).

Digital Camera

The device with an integrated camera based bar code scanning solution has the following features:

- Omnidirectional reading of a variety of bar code symbologies, including the most popular linear, postal, QR, PDF417, and 2D matrix code types.
- Cross-hair reticle for easy point-and-shoot operation.
- Picklist mode to decode a particular bar code from many in the field of view.

The solution uses the advanced camera technology to take a digital picture of a bar code, and executes state-of-the-art software decoding algorithms to extract the data from the image.

RS507 Hands-Free Imager

The RS507 Hands-free Imager is a wearable bar code scan solution for both 1D and 2D bar code symbologies. The scanner supports Simple Serial Interface (SSI) and Bluetooth Human Interface Device (HID) connection to the device.

Figure 32: RS507 Hands-Free Imager

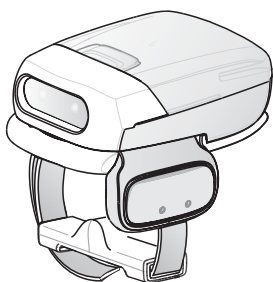

See to the *RS507 Hands-free Imager Product Reference Guide* for more information.

Scanning Considerations

Typically, scanning is a simple matter of aim, scan, and decode where a few quick trial efforts master it. However, consider the following to optimize scanning performance:

- Range
 - Any scanning device decodes well over a particular working range — minimum and maximum distances from the bar code. This range varies according to bar code density and scanning device optics.
 - Scanning within range brings quick and constant decodes; scanning too close or too far away prevents decodes. Move the scanner closer and farther away to find the right working range for the bar codes being scanned.
- Angle
 - Scan angle is important for promoting quick decodes. When laser beams reflect directly back into the scanner from the bar code, this specular reflection can “blind” the scanner.
 - To avoid this, scan the bar code so that the beam does not bounce directly back. But do not scan at too sharp an angle; the scanner needs to collect scattered reflections from the scan to make a successful decode. Practice quickly shows what tolerances to work within.
- Hold the device farther away for larger symbols.
- Move the device closer for symbols with bars that are close together.



Note: Scanning procedures depend on the application and device configuration. An application may use different scanning procedures from those described.

Bar Code Capture with Imager

To capture bar code data:

Procedure:

- 1 Ensure that an application is open on the device and a text field is in focus (text cursor in text field).
- 2 Point the top of the device at a bar code.

Figure 33: Bar Code Scanning

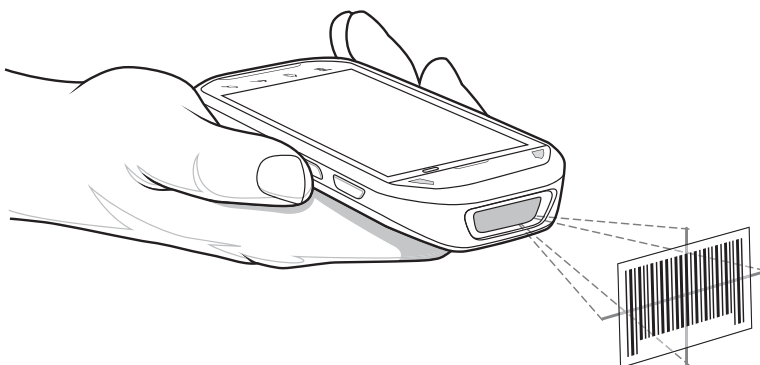

- 3 Press and hold the Scan button.

The red laser aiming pattern turns on to assist in aiming. Ensure the bar code is within the area formed by the cross-hairs in the aiming pattern. The aiming dot is used for increased visibility in bright lighting conditions.

The Left and Right LEDs light light green and a beep sounds to indicate the bar code was decoded successfully. Note that when the MC40 is in Pick List Mode, the MC40 does not decode the bar code until the center of the crosshair touches the bar code.

Figure 34: Aiming Pattern

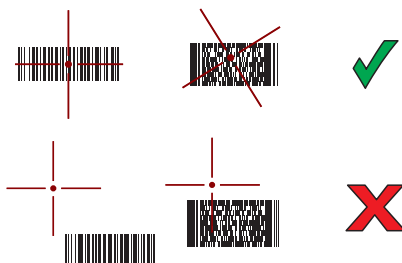

Figure 35: Pick List Mode with Multiple Bar Codes in Aiming Pattern



- 4 Release the scan button.
- 5 The captured data appears in the text field.

Bar Code Capture with Integrated Camera

To capture bar code data:

Procedure:

- 1 Ensure that an application is open on the device and a text field is in focus (text cursor in text field).
- 2 Aim the camera at a bar code.
- 3 Press and hold the Scan button. By default, a preview window appears on the screen. The Decode light emitting diode (LED) lights red to indicate that data capture is in process.

Figure 36: Application with Preview Window

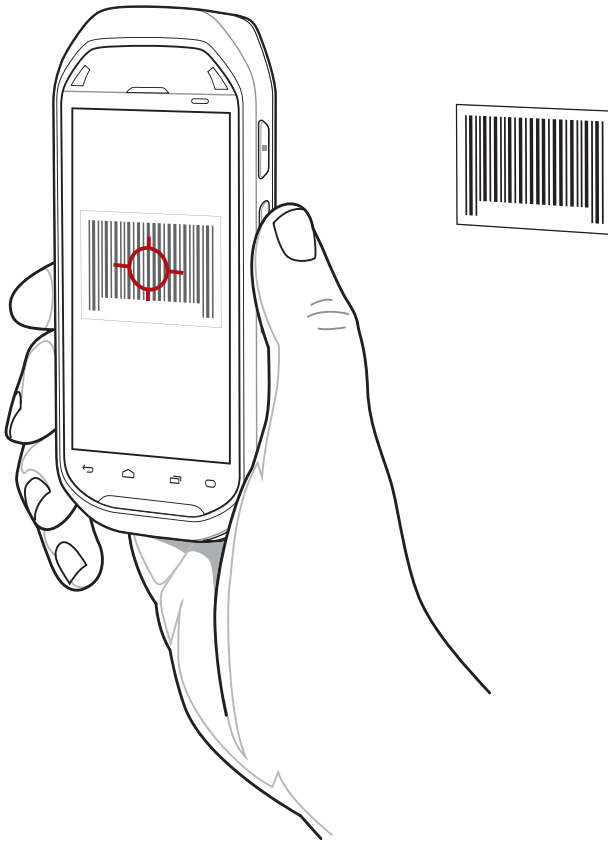

- 4 Move the device until the bar code is centered.
- 5 The Decode LED lights green and a beep sounds to indicate the bar code was decoded successfully.
- 6 The captured data appears in the text field.

Bar Code Capture with RS507 Hands-Free Imager

Prerequisites: Pair the RS507 with the MC40. See *Pairing the RS507 Hands-Free Imager Using SSI on page 54* or *Pairing the RS507 Hands-Free Imager Bluetooth HID on page 54* for more information.

Procedure:

- 1 Ensure that an application is open on the device and a text field is in focus (text cursor in text field).
- 2 Point the RS507 at a bar code.

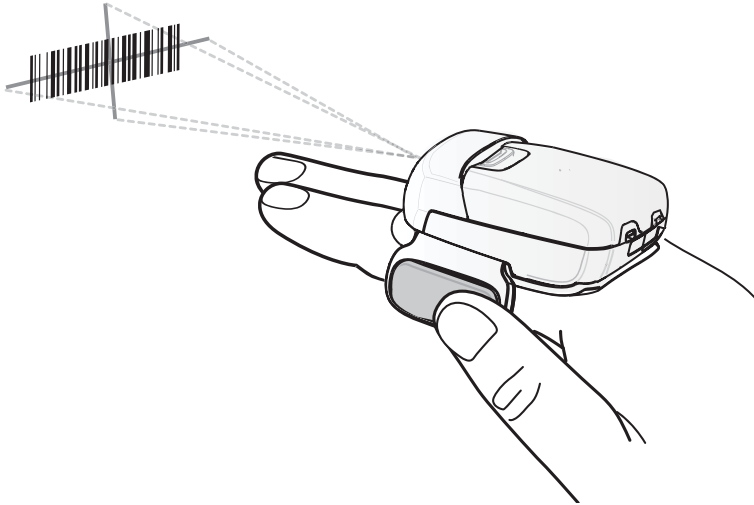
Figure 37: Bar Code Scanning with RS507

- 3 Press and hold the trigger.

The red laser aiming pattern turns on to assist in aiming. Ensure the bar code is within the area formed by the cross-hairs in the aiming pattern. The aiming dot is used for increased visibility in bright lighting conditions.

The RS507 LEDs light green, a beep sounds to indicate the bar code was decoded successfully. Note that when the RS507 is in Pick List Mode, the RS507 does not decode the bar code until the center of the crosshair touches the bar code.

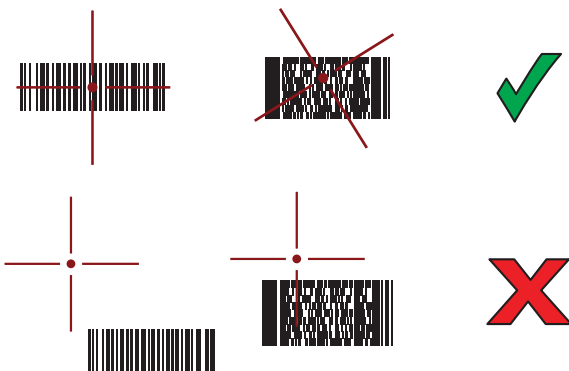
Figure 38: Aiming Pattern**Figure 39: Pick List Mode with Multiple Bar Codes in Aiming Pattern**

- 4 The captured data appears in the text field.

Pairing the RS507 Hands-Free Imager Using SSI

An RS507 Hands-free Imager can be used with the device to capture bar code data.

Procedure:



- 1 Ensure that the two devices are within 10 meters (32.8 feet) of one another.
- 2 Install the battery into the RS507.
- 3 On the MC40, touch .
- 4 Touch .

Figure 40: Bluetooth Pairing Utility



- 5 Using the RS507, scan the bar code on the screen.
The RS507 emits a high/low/high/low beeps. The Scan LED flashes green indicating that the RS507 is attempting to establish connection with the MC40. When connection is established, the Scan LED turns off and the RS507 emits one string of low/high beeps.
- 6 On the MC40, touch **Exit**.



Pairing the RS507 Hands-Free Imager Bluetooth HID

An RS507 Hands-free Imager can be used with the device to capture bar code data.

Procedure:

- 1 Ensure that Bluetooth is enabled on both devices.
- 2 Ensure that the Bluetooth device to discover is in discoverable mode.
- 3 Ensure that the two devices are within 10 meters (32.8 feet) of one another.
- 4 Place the RS507 in Human Interface Device (HID) mode. If the RS507 is already in HID mode, skip to step 5.
 - a Remove the battery from the RS507.
 - b Press and hold the Restore key.
 - c Install the battery onto the RS507.
 - d Keep holding the Restore key for about five seconds until a chirp is heard and the Scan LEDs flash green.
 - e Scan the bar code below to place the RS507 in HID mode.

Figure 41: RS507 Bluetooth HID Bar Code

- 5 Remove the battery from the RS507.
- 6 Re-install the battery into the RS507.
- 7 On the MC40, touch .
- 8 Touch .
- 9 Touch  **Bluetooth**.
- 10 Touch **SCAN FOR DEVICES**. The device begins searching for discoverable Bluetooth devices in the area and displays them under **AVAILABLE DEVICES**.
- 11 Scroll through the list and select RS507.
The device connects to the RS507 and **Connected** appears below the device name. The Bluetooth device is added to the **Bluetooth devices** list and a trusted (“paired”) connection is established.

Reading Magnetic Stripe Cards

Use the integrated MSR to read magnetic stripe card.



Note: Use the **Card Swipe Tutorial** application to practice swiping magnetic stripe cards through the MSR.

Procedure:

- 1 Ensure that **MSR input** is enabled in DataWedge and the cursor is in a text field.
- 2 Grip MC40 firmly in one hand.
- 3 Hold magnetic stripe card firmly in the other hand.
- 4 Align the magnetic stripe on the card toward the display and swipe the card smoothly in either direction.

Figure 42: Swiping a Magnetic Stripe Card

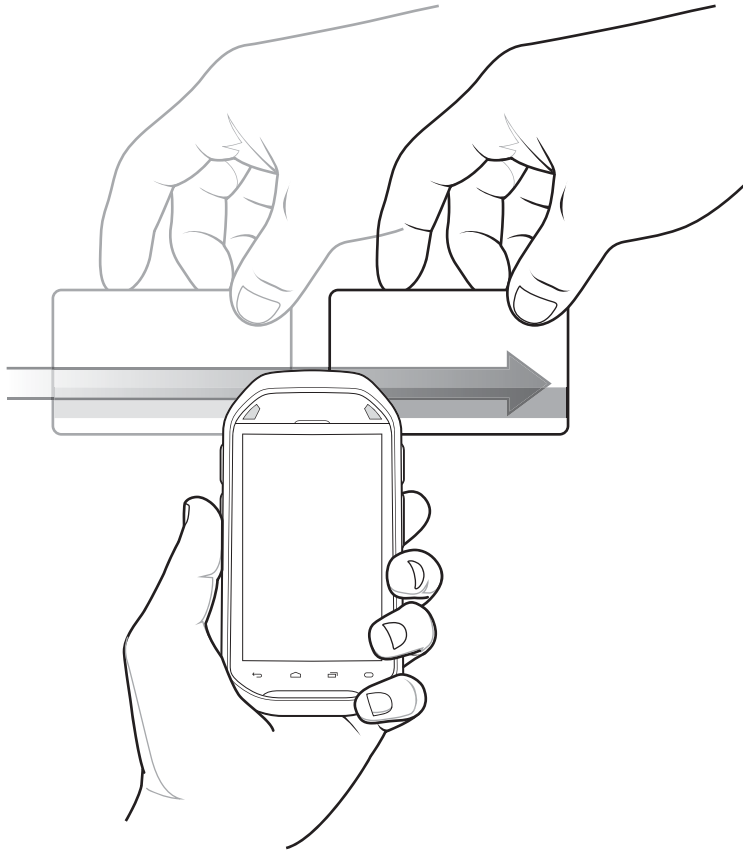

5 The captured data appears in the text field.

Improper Swiping

Figure 43: Do Not Start Swipe in Middle of Card



Figure 44: Avoid Thumb Hitting Device

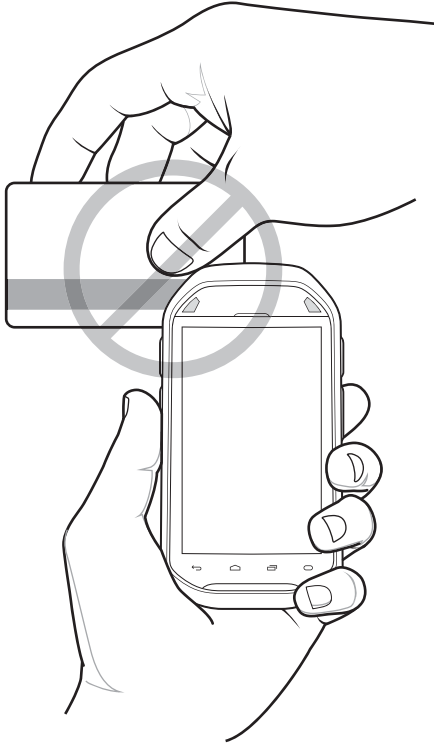

Figure 45: Do Not Hold End of Card While Swiping

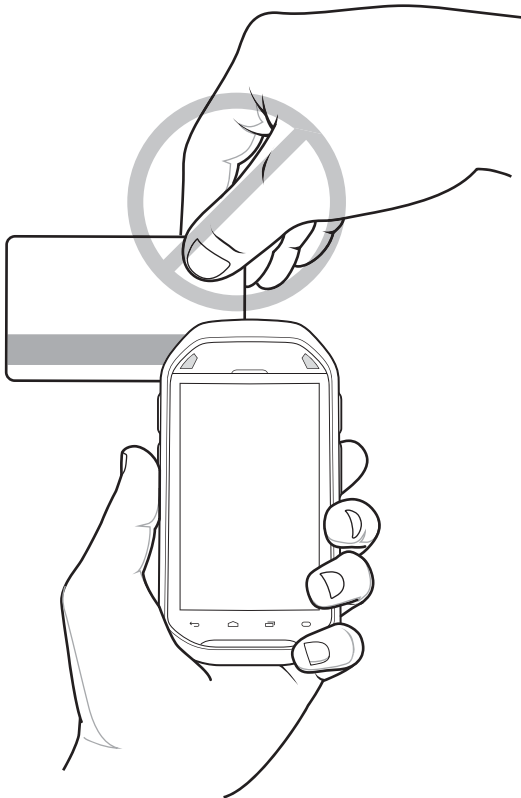
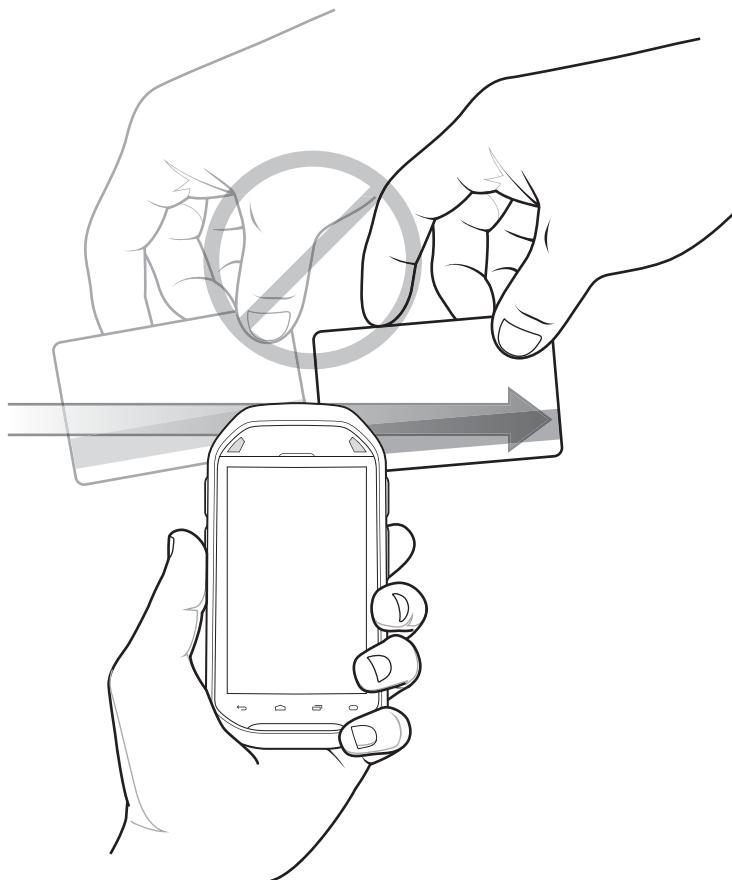

Figure 46: Do Not Swipe Card on Angle





DataWedge

DataWedge is a utility that adds advanced bar code scanning capability to any application without writing code. It runs in the background and handles the interface to built-in bar code scanners. The captured bar code data is converted to keystrokes and sent to the target application as if it was typed on the keypad.

To configure DataWedge refer to the *MC40 Integrator Guide*.





Enabling DataWedge

Procedure:

- 1 Touch .
- 2 Touch .
- 3 Touch .
- 4 Touch **Settings**.
- 5 Touch the **DataWedge enabled** checkbox. A blue checkmark appears in the checkbox indicating that DataWedge is enabled.
- 6 Touch .

Disabling DataWedge

Procedure:

- 1 Touch .
- 2 Touch .
- 3 Touch .
- 4 Touch **Settings**.
- 5 Touch the **DataWedge enabled** checkbox. The blue checkmark disappears from the checkbox indicating that DataWedge is disabled.
- 6 Touch .

Chapter 4

WLAN

Wireless local area networks (WLANs) allow the MC40 to communicate wirelessly inside a building. Before using the MC40 on a WLAN, the facility must be set up with the required hardware to run the WLAN (sometimes known as infrastructure). The infrastructure and the MC40 must both be properly configured to enable this communication.

Refer to the documentation provided with the infrastructure (access points (APs), access ports, switches, Radius servers, etc.) for instructions on how to set up the infrastructure.

Once the infrastructure is set up to enforce the chosen WLAN security scheme, use the **Wireless & networks** settings to configure the MC40 to match the security scheme.



Note: Turn off Wi-Fi when not using it, to extend the life of the battery.

The **Status** bar displays icons that indicate Wi-Fi network availability and Wi-Fi status. See *Status Bar on page 28* for more information.

Scan and Connect to a Wi-Fi Network

To set up WLAN on the device:

Procedure:

- 1 Touch .
- 2 Slide the Wi-Fi switch to the **On** position.
- 3 Touch **Wi-Fi**. The MC40 searches for WLANs in the area and lists them.

Figure 47: Wi-Fi Screen

- 4 Scroll through the list and select the desired WLAN network.
- 5 For open networks, touch **Connect** or for secure networks enter the required password or other credentials then touch **Connect**. See the system administrator for more information.

The MC40 obtains a network address and other required information from the network using the dynamic host configuration protocol (DHCP) protocol. To configure the MC40 with a fixed internet protocol (IP) address, Refer to the *MC40 Integrator Guide* for more information.

- 6 In the Wi-Fi setting field, **Connected** appears indicating that the MC40 is connected to the WLAN.

Chapter 5

Bluetooth

Bluetooth-equipped devices can communicate without wires, using frequency-hopping spread spectrum (FHSS) radio frequency (RF) to transmit and receive data in the 2.4 GHz Industry Scientific and Medical (ISM) band (802.15.1). Bluetooth wireless technology is specifically designed for short-range (10 meters (32.8 feet)) communication and low power consumption.

Devices with Bluetooth capabilities can exchange information (e.g., files, appointments, and tasks) with other Bluetooth enabled devices such as printers, access points, and other mobile devices.

Adaptive Frequency Hopping

Adaptive Frequency Hopping (AFH) is a method of avoiding fixed frequency interferers, and can be used with Bluetooth voice. All devices in the piconet (Bluetooth network) must be AFH-capable in order for AFH to work. There is no AFH when connecting and discovering devices. Avoid making Bluetooth connections and discoveries during critical 802.11b communications. AFH for Bluetooth consists of four main sections:

- Channel Classification - A method of detecting an interference on a channel-by-channel basis, or pre-defined channel mask.
- Link Management - Coordinates and distributes the AFH information to the rest of the Bluetooth network.
- Hop Sequence Modification - Avoids interference by selectively reducing the number of hopping channels.
- Channel Maintenance - A method for periodically re-evaluating the channels.

When AFH is enabled, the Bluetooth radio “hops around” (instead of through) the 802.11b high-rate channels. AFH coexistence allows Enterprise devices to operate in any infrastructure.

The Bluetooth radio in this device operates as a Class 2 device power class. The maximum output power is 2.5 mW and the expected range is 10 meters (32.8 ft.). A definition of ranges based on power class is difficult to obtain due to power and device differences, and whether one measures open space or closed office space.



Note: It is not recommended to perform Bluetooth wireless technology inquiry when high rate 802.11b operation is required.

Security

The current Bluetooth specification defines security at the link level. Application-level security is not specified. This allows application developers to define security mechanisms tailored to their specific need. Link-level security occurs between devices, not users, while application-level security can be implemented on a per-user basis. The Bluetooth specification defines security algorithms and procedures required to authenticate devices, and if needed, encrypt the data flowing on the link between the devices. Device authentication is a mandatory feature of Bluetooth while link encryption is optional.

Pairing of Bluetooth devices is accomplished by creating an initialization key used to authenticate the devices and create a link key for them. Entering a common personal identification number (PIN) in the devices being paired generates the initialization key. The PIN is never sent over the air. By default, the Bluetooth stack responds with no

key when a key is requested (it is up to user to respond to the key request event). Authentication of Bluetooth devices is based-upon a challenge-response transaction. Bluetooth allows for a PIN or passkey used to create other 128-bit keys used for security and encryption. The encryption key is derived from the link key used to authenticate the pairing devices. Also worthy of note is the limited range and fast frequency hopping of the Bluetooth radios that makes long-distance eavesdropping difficult.

Recommendations are:

- Perform pairing in a secure environment
- Keep PIN codes private and do not store the PIN codes in the device
- Implement application-level security.

Bluetooth Profiles

The MC40 supports the following Bluetooth services:

- Generic Access Profile (GAP) - Use for device discovery and authentication.
- Service Discovery Protocol (SDP) - Handles the search for known and specific services as well as general services.
- Serial Port Profile (SPP) - Sets up a virtual serial port and connects two Bluetooth enabled devices. For example, connecting the MC40 to a printer.
- Human Interface Device Profile (HID) - Allows Bluetooth keyboards, pointing devices, gaming devices and remote monitoring devices to connect to the MC40.
- Object Push Profile (OPP) - Allows the MC40 to push and pull objects to and from a push server.
- Dial-up Networking (DUN) - Allows the MC40 to access the Internet and other dial-up services using a Bluetooth enabled mobile phone.
- Headset Profile (HSP) - Allows a Bluetooth headset to communicate with the MC40.
- Advanced Audio Distribution Profile (A2DP) - Allows the MC40 to stream stereo-quality audio to a wireless headset or wireless stereo speakers.
- Audio/Video Remote Control Profile (AVRCP) - Allows the MC40 to control televisions, hi-fi equipment, etc.

Bluetooth Power States

The Bluetooth radio is off by default.

- **Suspend** — When the MC40 goes into suspend mode, the Bluetooth radio state is retained upon resume.
- **Airplane Mode** — When the MC40 is placed in Airplane Mode, the Bluetooth radio turns off. When in Airplane Mode, the Bluetooth radio can be turned back on if desired.

Bluetooth Radio Power – Android



Turn off the Bluetooth radio to save power or if entering an area with radio restrictions (e.g., an airplane). When the radio is off, other Bluetooth devices cannot see or connect to the device. Turn on the Bluetooth radio to exchange information with other Bluetooth devices (within range). Communicate only with Bluetooth radios in close proximity.



Note: To achieve the best battery life turn off radios when not in use.



Enabling Bluetooth

Procedure:

- 1 Touch .
- 2 Slide the Bluetooth switch to the **ON** position. The Bluetooth icon also appears in the Status bar.
- 3 Touch .

Disabling Bluetooth

Procedure:

- 1 Touch .
- 2 Slide the Bluetooth switch to the **OFF** position.
- 3 Touch .

Discovering Bluetooth Device(s)

The MC40 can receive information from discovered devices without pairing. However, once paired, the MC40 and the paired device will exchange information automatically when the Bluetooth radio is on.

Procedure:



- 1 Ensure that Bluetooth is enabled on the device to discover.
- 2 Ensure that the Bluetooth device to discover is in discoverable mode.
- 3 Ensure that the two devices are within 10 meters (32.8 feet) of one another.
- 4 Touch .
- 5 If Bluetooth is off, slide the switch to the **ON** position.
- 6 Touch  **Bluetooth**.
- 7 The MC40 begins searching for discoverable Bluetooth devices in the area and displays them under **Available Devices**.
- 8 Scroll through the list and select a device. The **Bluetooth pairing request** dialog box appears.

Figure 48: Bluetooth Pairing - Enter PIN

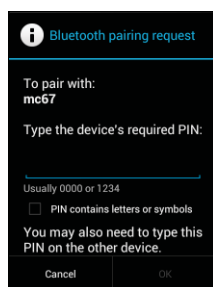
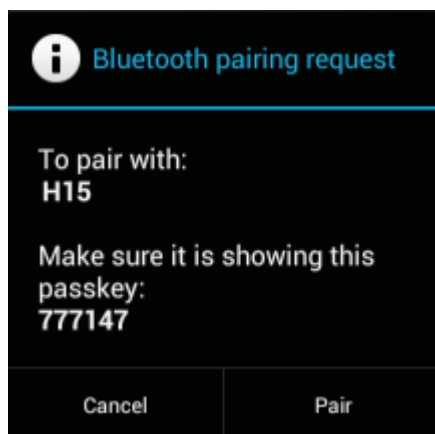





Figure 49: Bluetooth Pairing — Simple Pairing

- 9 Enter a PIN in the text box and touch **OK**.
- 10 Enter the same PIN on the other device. Touch **Pair**.
- 11 The Bluetooth device is added to the **Paired Devices** list and a trusted (“paired”) connection is established.

Changing the Bluetooth Name

By default, the MC40 has a generic Bluetooth name that is visible to other devices when connected.



Procedure:

- 1 Touch .
- 2 Touch  **Bluetooth**.
- 3 If Bluetooth is not on, slide the switch to the **ON** position.
- 4 Touch .
- 5 Touch **Rename device**.
- 6 In the **Rename device** dialog box, enter a name and touch **Rename**.
- 7 Touch .

Connecting to a Bluetooth Device

Once paired, connect to a Bluetooth device:





Procedure:

- 1 Touch .
- 2 Touch  **Bluetooth**.
- 3 If Bluetooth is not on, slide the switch to the **ON** position.
- 4 In the **PAIRED DEVICES** list, touch and hold on an unconnected Bluetooth device until a menu appears.
- 5 Touch **Connect**. When connected, the device is displayed as connected in the list.

Selecting Profiles on the Bluetooth Device



Some Bluetooth devices have multiple profiles. To select a profile:

Procedure:

- 1 Touch .
- 2 Touch  **Bluetooth**.
- 3 If Bluetooth is not turned on, slide the blue switch to the **ON** position.
- 4 In the **PAIRED DEVICES** list, touch  next to the device name.
- 5 Under **PROFILES**, check or uncheck a profile to allow the device to use that profile.
- 6 Touch .





Disconnecting from a Bluetooth Device

Procedure:

- 1 Touch .
- 2 Touch  **Bluetooth**.
- 3 In the **Bluetooth devices** list, touch and hold on a device until a menu appears.
- 4 Touch **Disconnect**.
- 5 Touch .

Unpairing a Bluetooth Device

Procedure:

- 1 Touch .
- 2 Touch  **Bluetooth**.
- 3 In the **Paired Devices** list, touch  next to the device name.
- 4 Touch **Unpair**.
- 5 Touch .

Chapter 6

Photos and Videos

This chapter provides information for taking photos and recording videos using the integrated digital cameras.



Note: Photos and videos are stored in Internal Storage.

Taking Photos



Note:

Camera settings are described in *Camera Settings on page 72*.

To take a photo:

Procedure:





- 1 Touch .
- 2 Touch .

Figure 50: Camera Mode



- 3 If necessary, touch the options bar and touch .
- 4 Touch  to adjust exposure, flash, and other settings using the camera settings. See *Camera Settings on page 72* for more information.



5 Touch  and to adjust the zoom level.

6 Frame the subject on screen.

7 Touch .

The camera brings the image into focus. When the image is in focus, the focus indicators in each corner turn green, the camera takes a photo and a shutter sound plays.



Note: To disable the shutter sound, turn notification sounds off. Touch  >  **Sounds** > **Volumes** and slide the **Notifications** slider all the way to the left.

Alternately, touch  and hold to focus first, before taking a photo; then release to take a focused photo.

The photo appears momentarily then displays as a thumbnail in the upper right corner.

8 Touch the thumbnail to view the photo in **Gallery**. See [Viewing Photos and Videos on page 73](#) for more information.

Taking a Panoramic Photo

Panorama mode lets the user create a single wide image by panning slowly across a scene. To take a panoramic photo:

Procedure:

1 Touch .



2 Touch .

3 Touch the options bar and touch .

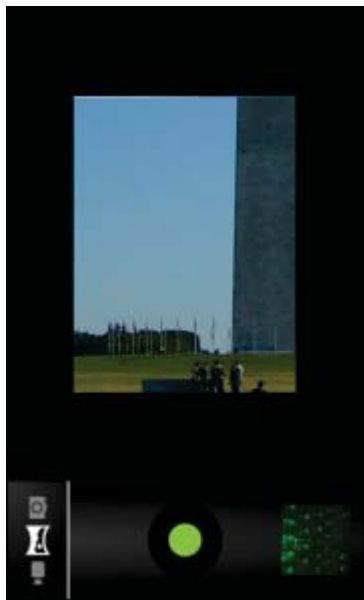
Figure 51: Panoramic Mode



4 Frame one side of the scene to capture.

- 5 Touch  and slowly start panning across the area to capture. A small white square appears inside the button indicating that the shot is in progress.
If panning too quickly, the message **Too fast** appears.
- 6 Touch  to end the shot. The panorama appears immediately and a progress indicator displays while it saves the image.
- 7 Touch the thumbnail to view the photo in **Gallery**. See *Viewing Photos and Videos on page 73*.

Recording Videos





To record a video:

Procedure:

- 1 Touch  > .
- 2 Touch the options bar and touch .

Figure 52: Video Mode



- 3 Touch  to adjust exposure, flash, and other settings using the video settings. See *Video Settings on page 72* for more information.
- 4 Touch  and  to adjust the zoom level.
- 5 Point the camera and frame the scene.
- 6 Touch  to start recording.
The device starts recording the video. The video time remaining appears in the top left of the screen.
- 7 Touch  to end recording.











Note: Previously recorded video displays in the thumbnail at the top right.

- 8 Touch the thumbnail to access the **Gallery** application. See *Viewing Photos and Videos on page 73*.

Camera Settings

When in Camera mode, Camera settings are displayed on screen.

Touch  to display the camera setting options.

-  **Settings** - Touch to open a scrolling list of settings:
 - **Focus Mode** - Touch to select the camera focus setting. Options: **Macro**, **Infinity**, **Continuous** or **Auto** (default).
 - **Capture Mode** - Touch to select the capture mode. Options: **High Quality** (default) or **Zero Shutter Lag**.
 - **Picture size** - Touch to set the size (in pixels) of the photo. Options: **8M pixels** (default), **5M pixels**, **3M pixels**, **2M pixels**, **1M pixels**, **VGA** or **QVGA**.
 - **ISO** - Options: **Auto** (default), **100**, **200**, **400** or **800**.
 - **Picture quality** - Touch to select picture quality setting. Options: **Super fine** (default), **Fine** or **Normal**.
 - **Restore defaults** - Touch **Restore defaults** to restore all camera settings to the default values.
- **SCN Scene mode** - Touch to select a preset combination of camera settings designed for specific scenes. Options: **Auto** (default), **Portrait**, **Landscape**, **Night**, **Steady Photo** or **Sports**.
-  **Exposure** - Touch to adjust the exposure settings. Options: **+3**, **+2**, **+1**, **0** (default), **-1**, **-2**, or **-3**.
-  **White balance** - Touch to select how Camera adjusts colors in different kinds of light, to achieve the most natural-looking colors.
 -  **Auto** - Adjust the white balance automatically (default).
 -  **Incandescent** - Adjust the white balance for incandescent lighting.
 -  **Daylight** - Adjust the white balance for daylight.
 -  **Fluorescent** - Adjust the white balance for florescent lighting.
 -  **Cloudy** - Adjust the white balance for a cloudy environment.

Video Settings

When in Video mode, Video settings are displayed on screen.

Touch  to display the video setting options.

-  **Settings** - Touch to open a scrolling list of settings:
 - **Restore defaults** - Touch **Restore defaults** to restore all video settings to the default values.
- **Video quality** - Touch to select video quality:
 - **HD 1080p** - High definition 1080p.
 - **HD 720p** - High definition 720p.
 - **SD 480p** - Standard definition 480p.
- **Time lapse interval** - Touch to select a time interval to set the frame rate for time lapse photography. Options: **Off** (default), **1s**, **1.5s**, **2s**, **2.5s**, **3s**, **5s** or **10s**.

- **AW White balance** - Touch to select how Camera adjusts colors in different kinds of light, to achieve the most natural-looking colors.
 - **AW Auto** - Adjust the white balance automatically (default).
 - **Incandescent** - Adjust the white balance for incandescent lighting.
 - **Daylight** - Adjust the white balance for daylight.
 - **Fluorescent** - Adjust the white balance for florescent lighting.
 - **Cloudy** - Adjust the white balance for a cloudy environment.

Viewing Photos and Videos





Note:

The device supports the following image formats: jpeg, gif, png and bmp.

The device supports the following video formats: H.263, H.264 and MPEG4 Simple Profile.

Use **Gallery** to:

- view photos
- play videos
- perform basic editing of photos
- set photos as wallpaper
- set photos as a contact photo
- share photos and videos.

To open the Gallery application, touch  >  or in the camera application touch the thumbnail image at the top right.

Gallery presents all photos and videos stored in the Internal Storage.

Figure 53: Gallery — Albums

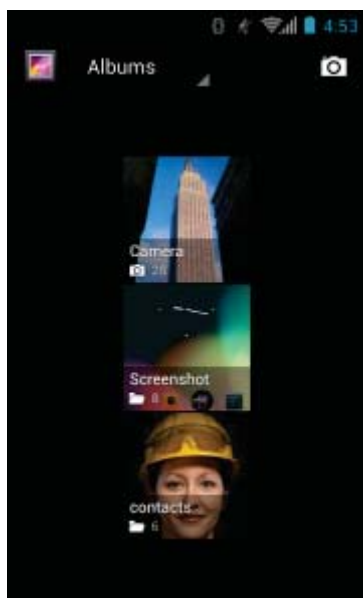

- Touch an album to open it and view its contents. The photos and videos in the album are displayed in chronological order.
- Touch a photo or video in an album to view it.
- Touch  icon (top left corner) to return to the main **Gallery** screen.

Working with Albums

Albums are groups of images and videos in folders. Touch an album to open it. The photos and videos are listed in a chronologically ordered grid. The name of the album displays at the top of the screen.



Figure 54: Photos Inside an Album



Swipe left or right to scroll images across the screen.



Share an Album

Procedure:

- 1 Touch .
- 2 Touch .
- 3 Touch and hold an album until it highlights.
- 4 Touch other albums as required.
- 5 Touch . The Share menu opens. Touch the application to use to share the selected albums.
- 6 Follow the instructions within the selected application.

Get Album Information

Procedure:



- 1 Touch .
- 2 Touch .

- 3 Touch and hold an album until it highlights.
- 4 Touch .
- 5 Touch **Details**.

Deleting an Album

To delete an album and its contents from the microSD card:

Procedure:

- 1 Touch .
- 2 Touch .
- 3 Touch and hold an album until it highlights.
- 4 Check other albums to delete. Ensure that other albums are selected.
- 5 Touch .
- 6 In the **Delete selected item?** menu, touch **OK** to delete the album.

Working with Photos

Use **Gallery** to view photos on the microSD card and edit and share photos.

Viewing and Browsing Photos

To view a photo:

Procedure:



- 1 Touch .
- 2 Touch .
- 3 Touch an album to open it.
- 4 Touch a photo.

Figure 55: Photo Example



- 5 Swipe left or right to view the next or previous photo in the album.
- 6 Turn the device to view the photo in upright (portrait) or sideways (landscape) orientation. The photo is displayed (but not saved) in the new orientation.
- 7 Touch the photo to view the controls.
- 8 Double-tap the screen to zoom in or pinch two fingers together or spread them apart to zoom in or out.
- 9 Drag the photo to view parts that are not in view.

Rotating a Photo

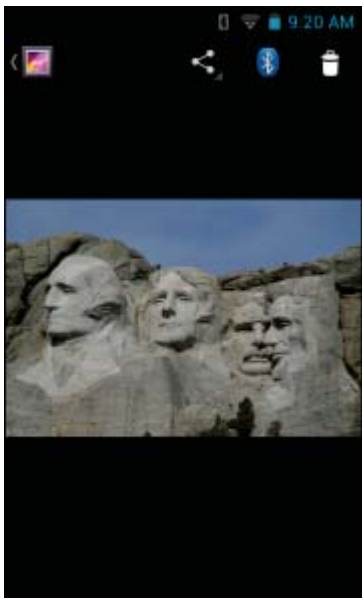
Procedure:

- 1 Touch a photo to view the controls.
- 2 Touch .
- 3 Touch **Rotate Left** or **Rotate Right**.
The photo is automatically saved with the new orientation.

Cropping a Photo

Procedure:

- 1 In **Gallery**, touch a photo to view the controls.
- 2 Touch .
- 3 Touch **Crop**. The blue cropping tool appears.
- 4 Use the cropping tool to select the portion of the photo to crop.
 - Drag from the inside of the cropping tool to move it.
 - Drag an edge of the cropping tool to resize it to any proportion.
 - Drag a corner of the cropping tool to resize it with fixed proportions.



Figure 56: Cropping Tool



- 5 Touch **OK** to save a copy of the cropped photo. The original version is retained.

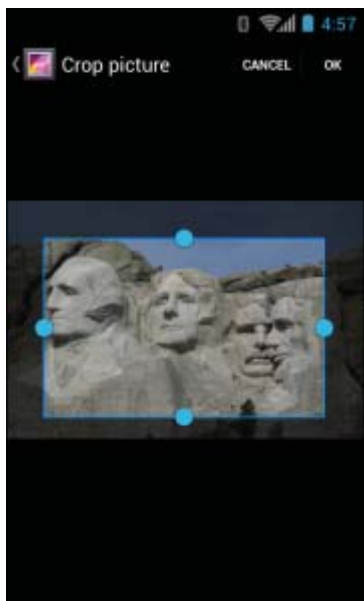

Get Photo Information

Procedure:

- 1 Touch .
- 2 Touch .
- 3 Touch an album to open it.
- 4 Touch the photo to open it.
- 5 Touch .
- 6 Touch **Details**.
- 7 Touch **Close**.



Share a Photo

Procedure:

- 1 Touch .
- 2 Touch .
- 3 Touch an album to open it.
- 4 Touch a photo to open it.
- 5 Touch .
- 6 Touch the application to use to share the selected photo. The application selected opens with the photo attached to a new message.

Deleting a Photo

Procedure:



- 1 Touch .
- 2 Touch .
- 3 Touch an album to open it.
- 4 Touch a photo to open it.
- 5 Touch .
- 6 Touch **OK** to delete the photo.

Working with Videos

Use **Gallery** to view videos on the microSD card and share videos.

Watching Videos

Procedure:

- 1 Touch .
- 2 Touch .
- 3 Touch an album to open it.

- 4 Touch a video.



Figure 57: Video Example



- 5 Touch . The video begins to play.
- 6 Touch the screen to view the playback controls.



Sharing a Video

Procedure:

- 1 Touch .
- 2 Touch .
- 3 Touch an album to open it.
- 4 Touch a video to open it.
- 5 Touch . The Share menu appears.
- 6 Touch the application to use to share the selected video. The application selected opens with the video attached to a new message.

Deleting a Video

Procedure:

- 1 Touch .
- 2 Touch .
- 3 Touch an album to open it.
- 4 Touch a video to open it.
- 5 Touch .
- 6 Touch **OK**.

Chapter 7

Accessories

This chapter provides information for using the accessories for the device.

MC40 Accessories

Table 10: MC40 Accessories on page 79 lists the accessories available for the MC40.

Table 10: MC40 Accessories

Accessory	Part Number	Description
Cradles		
Single Slot Charge Only Cradle	CRDMC40XX-1000R	Charges the MC40.
Five Slot Charge Only Cradle Base	CRDUNIV-XX-5000R	Provides charging for up to five MC40 devices or four MC40 devices and one Four Slot Battery Charger using optional Charging Cups. Requires additional power supplies.
Five Slot Charge Only Cradle	CRDUNIV-40-5000R	Provides charging for up to five MC40 devices.
Chargers		
Four Slot Battery Charger	SACMC40XX-4000R	Charges up to four MC40 batteries.
Power Supply	PWRS-124306-01R	Provides power to the MC40 and Single Slot Charge Cradle.
Power Supply (12 VDC, 4.16 A)	PWRS-14000-148C	Provides power to the Five Slot Charge Only Cradle and the Four Slot Battery Charger.
Cables		
Micro USB Cable	25-MCXUSB-01R	Provides power to the MC40 and USB communication with a host computer.
US AC Line Cord (3-wire)	23844-00-00R	Provides power to the power supplies.
2-way DC Cable	25-122026-02R	Connects one power supply (PWRS-14000-148C) to two Four Slot Battery Chargers.
4-way DC Cable	25-85992-01R	Connects one power supply (PWRS-14000-241R) to four Four Slot Battery Chargers.

Table continued...

Accessory	Part Number	Description
Miscellaneous		
Spare 2680 mAh lithium-ion battery	BTRY-MC40EAB0E	Replacement 2680 mAh battery.
	BTRY-MC40EAB0E-10R	Replacement 2680 mAh battery (10-pack)
Charging Cup	CUPMC40XX-1000R	Mounts onto the Five Slot Charge Only Cradle Base and provides MC40 charging slot (Single pack).
Battery Charger Cup	CUPUNIBTRY-1000R	Mounts on the Five Slot Charge Only Cradle Base and provides mounting for the Four Slot Battery Charger.
Universal Blank Slot Cover	CUPUNICVR-5000R	Mounts on the Five Slot Charge Only Cradle and covers a slot when a cup is not required (5-pack).
Protective Rubber Boot	SG-MC40-RBOOT-01R	Provides additional protection for the MC40.
	SG-MC40-RBOOT-10R	Provides additional protection for the MC40 (10-pack).
Soft Hip Holster	SG-MC40HLSTR-02R	Mounts on belt and provides storage for the MC40.
Finger Strap	SG-MC40STRAP-01R	Mounts on the back of the MC40 and provides secure option for holding the device (Single pack or 10-pack).
	SG-MC40STRAP-10R	
Rack/Wall Mount Bracket	KT-UNIVLBRKT-01R	Provides for mounting the Five Slot Charge Only Cradle onto a standard rack or wall.
Wired Headset	HDST-25MM-PTVP-01	2.5 mm wired headset for PTT and VoIP telephony communications.

Micro USB Cable

Use the Micro USB cable to connect the MC40 to the power supply for charging or to a host computer for communication.

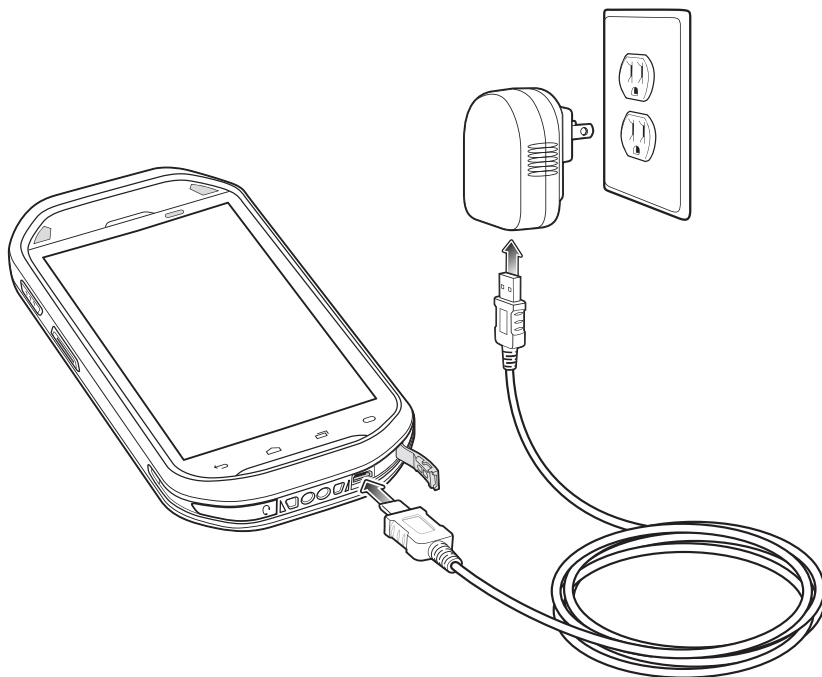
Figure 58: Charging Using the Micro USB Cable

Communication

When the MC40 is connected to a host computer using the Micro USB cable, the MC40 appears as a Removable Disk on the host computer. Refer to the MC40 Integrator Guide for more information.

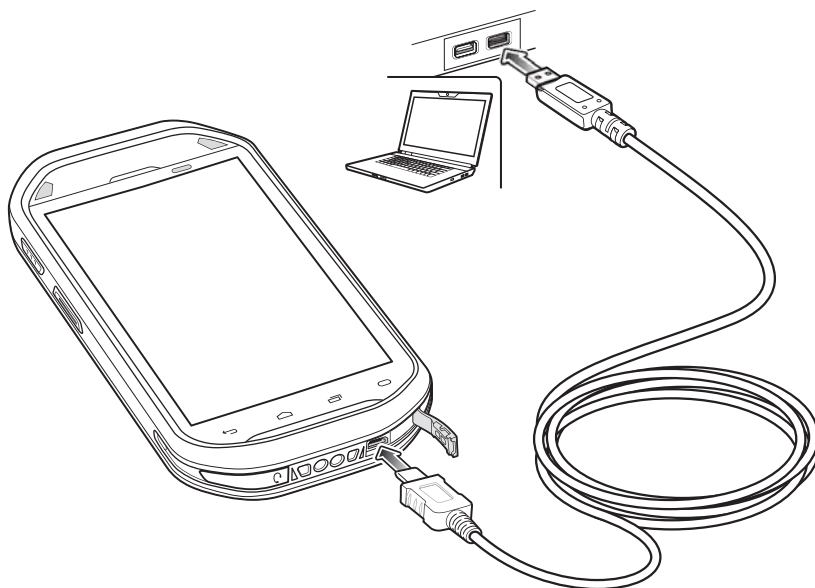
Figure 59: Communication Using the Micro USB Cable

Single Slot Charge Cradle

The Single Slot Charge Cradle provides 5 VDC power for operating the MC40 and charging the battery.



Charging the MC40 Battery

Connect the cradle to power. Insert the MC40 into the slot to begin charging.

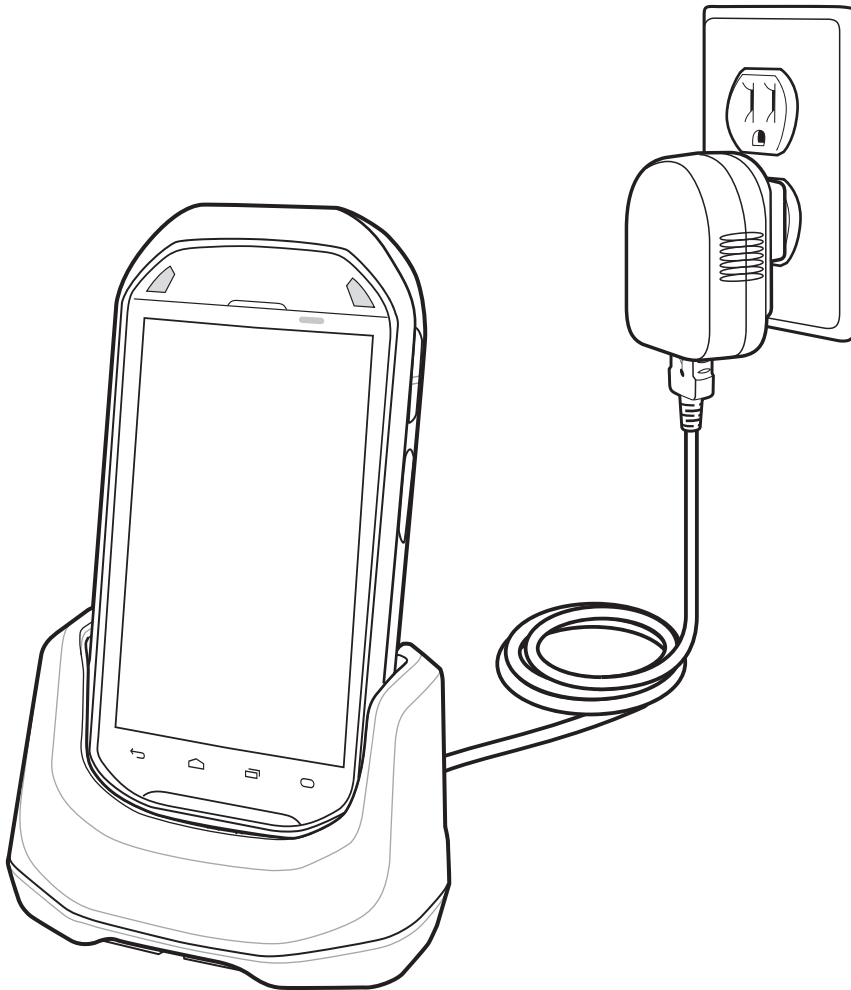
Figure 60: MC40 Battery Charging



The MC40's Right light emitting diode (LED) indicates the status of the battery charging in the MC40. See [Table 3: Battery Charge LED Status on page 19](#) for charging status indications. The 2680 mAh battery charges in approximately four hours.

Charge batteries in ambient temperatures from 0 °C to 40 °C (32 °F to 104 °F) or up to 45 °C (113 °F) as reported by the battery. To view the battery temperature, touch  >  **About device > Battery Information.**

Note that charging is intelligently controlled by the MC40. To accomplish this, for small periods of time, the MC40 or accessory alternately enables and disables battery charging to keep the battery at acceptable temperatures. The MC40 or accessory indicates when charging is disabled due to abnormal temperatures via its Right LED. See [Table 3: Battery Charge LED Status on page 19](#).

Five Slot Charge Only Cradle

The Five Slot Charge Only Cradle:

- Provides 5 VDC power for operating the MC40.
- Simultaneously charges up to five MC40s.

- Consists of a cradle base and optional cups that can be configured for various charging requirements.
- Provides mounting for a Four Slot Battery Charger (requires separate power supply).

See the *MC40 Integrator Guide* for setup and configuration instructions. To charge the MC40, insert the MC40 into an open slot.

Figure 61: Charging MC40s and Spare Batteries

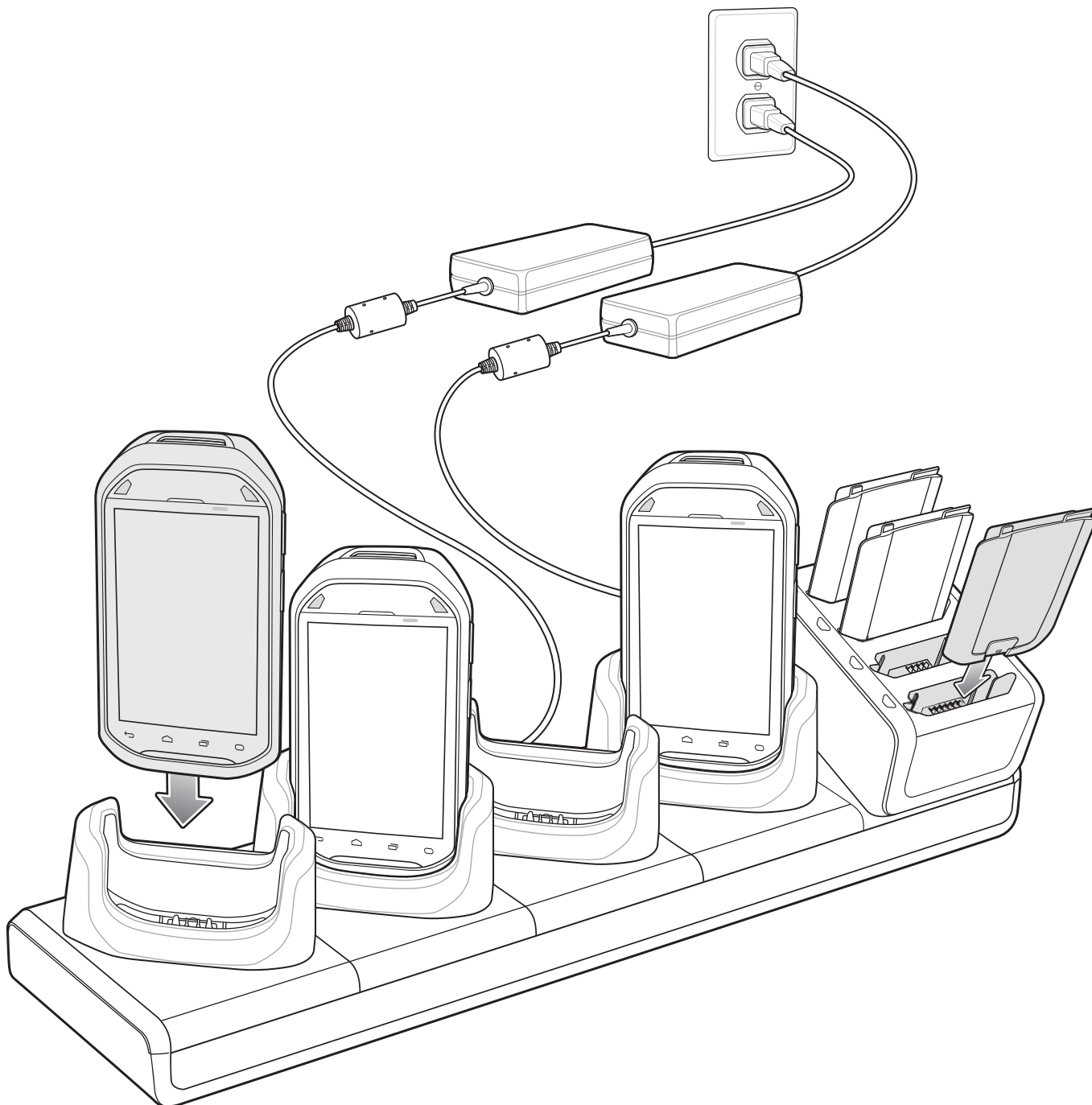

The MC40's Right LED shows the status of the battery charging. See [Table 3: Battery Charge LED Status on page 19](#) for charging status indications. The 2680 mAh battery charges in approximately four hours.

Charge batteries in ambient temperatures from 0 °C to 40 °C (32 °F to 104 °F) or up to 45 °C (113 °F) as reported by the battery. To view the battery temperature, touch  > ⓘ About device > **Battery Information**.

Note that charging is intelligently controlled by the MC40. To accomplish this, for small periods of time, the MC40 or accessory alternately enables and disables battery charging to keep the battery at acceptable temperatures. The MC40 or accessory indicates when charging is disabled due to abnormal temperatures via its Right LED. See [Table 3: Battery Charge LED Status on page 19](#).

Four Slot Battery Charger

The Four Slot Battery Charger:

- Provides 12 VDC power for charging the batteries.
- Simultaneously charges up to four MC40 batteries.

To charge a spare battery:

Figure 62: Four Slot Battery Charger

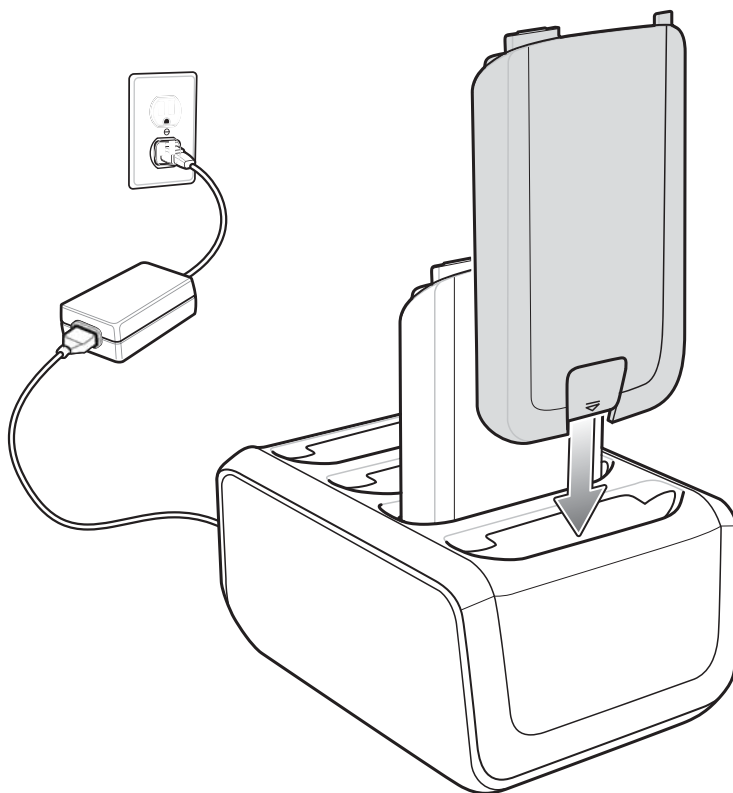

The Four Slot Battery Charger has four amber Battery Charging LEDs, one for each battery charging well. The 2680 mAh battery charges in approximately four hours.

Charge batteries in ambient temperatures from 0 °C to 40 °C (32 °F to 104 °F) or up to 45 °C (113 °F) as reported by

the battery. To view the battery temperature, touch  >  **About device > Battery Information**. Charging is intelligently controlled by the MC40. To accomplish this, for small periods of time, the charger alternately enables and disables battery charging to keep the battery at acceptable temperatures. The charger indicates when charging is disabled due to abnormal temperatures via its LED.

Table 11: Spare Battery Charge LED Status

Status	Indications
Off	No battery in a slot. Battery is not charging. Battery is not inserted correctly in the charger. Charger is not powered.
Slow Blinking Amber	Battery is charging.
Solid Green	Charging complete.
Fast Blinking Amber	Charging error, e.g.: <ul style="list-style-type: none">• Temperature is too low or too high.• Charging has gone on too long without completion.

Chapter

8

Maintenance and Troubleshooting

This chapter includes instructions on cleaning and storing the device, and provides troubleshooting solutions for potential problems during operation.

Maintaining the MC40

For trouble-free service, observe the following tips when using the MC40:

- Do not scratch the screen of the MC40. When working with the MC40, use only a finger. Never use an actual pen or pencil or other sharp object on the surface of the MC40 screen.
- The touch-sensitive screen of the MC40 is glass. Do not to drop the MC40 or subject it to strong impact.
- Protect the MC40 from temperature extremes. Do not leave it on the dashboard of a car on a hot day, and keep it away from heat sources.
- Do not store or use the MC40 in any location that is dusty, damp, or wet.
- Use a soft lens cloth to clean the MC40. If the surface of the MC40 screen becomes soiled, clean it with a soft cloth moistened with a diluted window-cleaning solution.
- Periodically replace the rechargeable battery to ensure maximum battery life and product performance. Battery life depends on individual usage patterns.

Battery Safety Guidelines

- The area in which the units are charged should be clear of debris and combustible materials or chemicals. Particular care should be taken where the device is charged in a non commercial environment.
- Follow battery usage, storage, and charging guidelines found in this guide.
- Improper battery use may result in a fire, explosion, or other hazard.
- To charge the mobile device battery, the battery and charger temperatures must be between +32 °F and +104 °F (0 °C and +40 °C)
- Do not use incompatible batteries and chargers. Use of an incompatible battery or charger may present a risk of fire, explosion, leakage, or other hazard. If you have any questions about the compatibility of a battery or a charger, contact Zebra Customer Support Center.
- For devices that utilize a USB port as a charging source, the device shall only be connected to products that bear the USB-IF logo or have completed the USB-IF compliance program.
- Do not disassemble or open, crush, bend or deform, puncture, or shred.
- Do not short circuit a battery or allow metallic or conductive objects to contact the battery terminals.
- Do not modify or remanufacture, attempt to insert foreign objects into the battery, immerse or expose to water or other liquids, or expose to fire, explosion, or other hazard.
- Do not leave or store the equipment in or near areas that might get very hot, such as in a parked vehicle or near a radiator or other heat source. Do not place battery into a microwave oven or dryer.
- Battery usage by children should be supervised.
- Please follow local regulations to properly dispose of used re-chargeable batteries.

- Do not dispose of batteries in fire.
- In the event of a battery leak, do not allow the liquid to come in contact with the skin or eyes. If contact has been made, wash the affected area with large amounts of water and seek medical advice.
- If you suspect damage to your equipment or battery, contact Zebra Customer Support Center to arrange for inspection.

Cleaning Instructions

**Caution:**

Always wear eye protection.

Read warning label on compressed air and alcohol product before using.

If you have to use any other solution for medical reasons please contact the Global Customer Support Center for more information.



Warning: Avoid exposing this product to contact with hot oil or other flammable liquids. If such exposure occurs, unplug the device and clean the product immediately in accordance with these guidelines.

Approved Cleanser Active Ingredients

100% of the active ingredients in any cleaner must consist of one or some combination of the following: isopropyl alcohol, bleach/sodium hypochlorite, hydrogen peroxide or mild dish soap.

Harmful Ingredients

The following chemicals are known to damage the plastics on the device and should not come in contact with the device: ammonia solutions, compounds of amines or ammonia; acetone; ketones; ethers; aromatic and chlorinated hydrocarbons; aqueous or alcoholic alkaline solutions; ethanolamine; toluene; trichloroethylene; benzene; carbolic acid and TB-lysoform.

Cleaning Instructions

Do not apply liquid directly to the device. Dampen a soft cloth or use pre-moistened wipes. Do not wrap the device in the cloth or wipe, but gently wipe the unit. Be careful not to let liquid pool around the display window or other places. Allow the unit to air dry before use.

Special Cleaning Notes

Many vinyl gloves contain phthalate additives, which are often not recommended for medical use and are known to be harmful to the housing of the device. The device should not be handled while wearing vinyl gloves containing phthalates, or before hands are washed to remove contaminant residue after gloves are removed. If products containing any of the harmful ingredients listed above are used prior to handling the device, such as hand sanitizer that contain ethanolamine, hands must be completely dry before handling the device to prevent damage to the plastics.

Cleaning Materials Required

- Alcohol wipes
- Lens tissue
- Cotton-tipped applicators
- Isopropyl alcohol
- Can of compressed air with a tube.

Cleaning Frequency

The cleaning frequency is up to the customer's discretion due to the varied environments in which the mobile devices are used. They may be cleaned as frequently as required, but it is advisable to clean the camera window periodically when used in dirty environments to ensure optimum performance.

Cleaning the MC40

Housing

Using the alcohol wipes, wipe the housing including keys and in-between keys.

Display

The display can be wiped down with the alcohol wipes, but care should be taken not to allow any pooling of liquid around the edges of the display. Immediately dry the display with a soft, non-abrasive cloth to prevent streaking.

Exit and Camera Window

Wipe the camera window periodically with a lens tissue or other material suitable for cleaning optical material such as eyeglasses.

Connector Cleaning

To clean the connectors:

Procedure:

- 1 Remove the main battery from mobile computer.
- 2 Dip the cotton portion of the cotton-tipped applicator in isopropyl alcohol.
- 3 Rub the cotton portion of the cotton-tipped applicator back-and-forth across the connector. Do not leave any cotton residue on the connector.
- 4 Repeat at least three times.
- 5 Use the cotton-tipped applicator dipped in alcohol to remove any grease and dirt near the connector area.
- 6 Use a dry cotton-tipped applicator and repeat steps 4 through 6.



Caution: Do not point nozzle at yourself and others, ensure the nozzle or tube is away from your face.

- 7 Spray compressed air on the connector area by pointing the tube/nozzle about ½ inch away from the surface.
- 8 Inspect the area for any grease or dirt, repeat if required.

Cleaning Cradle Connectors

To clean the connectors on a cradle:

Procedure:

- 1 Remove the DC power cable from the cradle.
- 2 Dip the cotton portion of the cotton-tipped applicator in isopropyl alcohol.
- 3 Rub the cotton portion of the cotton-tipped applicator along the pins of the connector. Slowly move the applicator back-and-forth from one side of the connector to the other. Do not leave any cotton residue on the connector.
- 4 All sides of the connector should also be rubbed with the cotton-tipped applicator.



Caution: Do not point nozzle at yourself and others, ensure the nozzle or tube is pointed away from your face.





- 5 Spray compressed air in the connector area by pointing the tube/nozzle about ½ inch away from the surface.
- 6 Remove any lint left by the cotton-tipped applicator.
- 7 If grease and other dirt can be found on other areas of the cradle, use a lint-free cloth and alcohol to remove.
- 8 Allow at least 10 to 30 minutes (depending on ambient temperature and humidity) for the alcohol to air dry before applying power to cradle.
If the temperature is low and humidity is high, longer drying time is required. Warm temperature and dry humidity requires less drying time.

Troubleshooting the MC40

Table 12: Troubleshooting the MC40

Problem	Cause	Solution
When the user presses the Power button, the MC40 does not turn on.	Battery is completely discharged.	Re-charge or replace the battery.
	Battery not installed properly.	Install the battery properly. See <i>Installing the Battery on page 18</i> .
	Power button not held down long enough.	Press the Power button until the Right LED flashes once.
	MC40 not responding.	Perform a hard reset. See <i>Resetting the Device on page 41</i> .
When the user presses the Power button the MC40 does not turn on but the Decode LED blinks amber.	Battery charge level is very low.	Re-charge or replace the battery.
Battery did not charge.	Battery failed.	Replace battery. If the MC40 still does not operate, perform a hardware reset. See <i>Resetting the Device on page 41</i> .
	MC40 was removed from power while battery was charging.	Insert MC40 in cradle. The 2680 mAh battery fully charges in less than four hours.
	Extreme battery temperature.	Battery does not charge if ambient temperature is below 0 °C (32 °F) or above 40 °C (104 °F).
During data communication, no data transmitted, or transmitted data was incomplete.	MC40 disconnected from host computer during communication.	Reattach the communication cable and re-transmit.
	Incorrect cable configuration.	See the system administrator.

Table continued...

Problem	Cause	Solution
No sound.	Volume setting is low or turned off.	Adjust the volume.
MC40 turns off.	MC40 is inactive.	The display turns off after a period of inactivity. Set this period to 15 seconds, 30 seconds, 1, 2, 10, or 30 minutes.
	Battery is depleted.	Recharge or replace the battery.
A message appears stating not enough storage memory.	Too many applications installed on the MC40.	Remove user-installed applications on the MC40 to recover memory. Select  >  Apps > Downloaded . Select the unused programs and touch Uninstall .
The MC40 does not decode when reading bar code.	DataWedge is not enabled.	Ensure that DataWedge is enabled and configured properly. Refer to the <i>MC40 Integrator Guide</i> for more information.
	Unreadable bar code.	Ensure the symbol is not defaced.
	Distance between the MC40 and bar code is incorrect.	Place the MC40 within proper scanning range.
	MC40 is not programmed for the bar code type.	Program the MC40 to accept the type of bar code being scanned. Refer to the <i>MC40 Integrator Guide</i> for DataWedge configuration.
	MC40 is not programmed to generate a beep.	If the MC40 does not beep on a good decode, set the application to generate a beep on good decode.
MC40 cannot find any Bluetooth devices nearby.	Too far from other Bluetooth devices.	Move closer to the other Bluetooth device(s), within a range of 10 meters (30 feet).
	The Bluetooth device(s) nearby are not turned on.	Turn on the Bluetooth device(s) to find.
	The Bluetooth device(s) are not in discoverable mode.	Set the Bluetooth device(s) to discoverable mode. If needed, refer to the device's user documentation for help.
MC40 does not read magnetic stripe card.	Magnetic stripe on the card is facing the wrong way.	Ensure that magnetic stripe card is oriented correctly. Magnetic stripe on the card should be facing the display.
Cannot connect to WLAN.	Access Point (AP) does not broadcast country code.	Disable 802.11d feature. Touch  > Wi-Fi >  > Advanced . Deselect the Enable 802.11d checkbox.
Wired headset is not working as headset hook or not able to initiate a PTT call even through wired headset.	Wired headset not connected properly.	Ensure that the wired headset is connected properly.





Single-Slot Charge Cradle Troubleshooting

Table 13: Troubleshooting the Single-slot Charge Cradle

Problem	Cause	Solution
MC40 battery is not charging.	MC40 was removed from cradle or cradle was unplugged from AC power too soon.	Ensure cradle is receiving power. Ensure MC40 is seated correctly. Confirm the battery is charging. The 2680 mAh battery charges in approximately four hours.
	Battery is faulty.	Verify that other batteries charge properly. If so, replace the faulty battery.
	The MC40 is not fully seated in the cradle.	Remove and re-insert the MC40 into the cradle, ensuring it is firmly seated.
	Extreme battery temperature.	Battery does not charge if ambient temperature is below 0 °C (32 °F) or above 40 °C (104 °F).

Five-Slot Charge Only Cradle CRDUNIV-40-5000R Troubleshooting

Table 14: Troubleshooting the Five-Slot Charge Only Cradle

Problem	Cause	Solution
Battery is not charging.	MC40 removed from the cradle too soon.	Replace the MC40 in the cradle. The 2680 mAh battery charges in approximately four hours. Touch  >  About device > Status to view battery status.
	Battery is faulty.	Verify that other batteries charge properly. If so, replace the faulty battery.
	MC40 is not inserted correctly in the cradle.	Remove the MC40 and reinsert it correctly. Verify charging is active. Touch  >  About device > Status to view battery status.
	Ambient temperature of the cradle is too warm.	Move the cradle to an area where the ambient temperature is between 0 °C (32 °F) and 35 °C (95 °F).
Spare batteries are not charging in Four Slot Battery Charger.	Missing Four Slot Battery Charger power supply.	The Four Slot Battery Charger requires a separate power supply. Obtain the correct power supply and connect to the charger.

Four-Slot Battery Charger SACMC40XX-4000R Troubleshooting

Table 15: Troubleshooting the Four-slot Battery Charger

Problem	Cause	Solution
Battery not charging.	Battery was removed from the charger or charger was unplugged from AC power too soon.	Re-insert the battery in the charger or re-connect the charger's power supply. The 2680 mAh battery charges in approximately four hours.
	Battery is faulty.	Verify that other batteries charge properly. If so, replace the faulty battery.
	Battery contacts not connected to charger.	Verify that the battery is seated in the battery well correctly with the contacts facing down.

Chapter

9

Technical Specifications

The following sections provide technical specification for the device.

MC40 Technical Specifications

The following table summarizes the MC40's intended operating environment and technical hardware specifications.

Table 16: MC40 Technical Specifications

Item	Description
Physical Characteristics	
Dimensions	Height: 143.9 mm (5.66 in.) Width: 72.8 mm (2.87 in.) Non-MSR: Depth: 20.1 mm (0.79 in.) MSR: Depth: 31.8 mm (1.25 in.)
Weight	Non-MSR: 257.7 g (9.09 oz.) MSR: 266.1 g (9.38 oz.)
Display	4.3 in. capacitive; 480 x 800; 300 nit
Touch Panel	Capacitive dual-touch
Backlight	LED backlight
Battery	Rechargeable Lithium Ion 3.7V, 2680 mAh Smart battery.
Backup Battery	NiMH battery (rechargeable) 15 mAh 3.6 V (not user accessible).
Connectivity	One USB 2.0 OTG connector.
Notification	LED, audio and vibration.
Keypad Options	On-screen keyboard.
Audio	Speakers, microphone and headset connector (mono, 2.5 mm jack with microphone). Stereo audio through Bluetooth stereo headsets.
Disinfectant Ready	Yes (Healthcare version)
Colors	Silver, Healthcare Blue and White
Communications	All models: Push-to-Talk. PTT Express Client pre-loaded. VoIP Telephony Ready models: Optimized for VoIP telephony. VoIP client not included.

Table continued...

Item	Description
Performance Characteristics	
CPU	Texas Instruments OMAP 4430 @ 800 MHz, dual-core.
Operating System	Android-based ASOP 4.1.1.
Memory	1 GB RAM, 8 GB Flash.
Output Power (USB)	Docking Connector: 5 VDC @ 500 mA max.
User Environment	
Operating Temperature	0°C to 50°C (32°F to 122°F)
Storage Temperature	-40°C to 70°C (-40°F to 158°F)
Charging Temperature	0° C to 40° C (32°F to 104°F)
Humidity	5% to 95% RH non-condensing
Drop Specification	Multiple 1.2 m (4 ft.) drops to plywood per MIL-STD 810G specifications. Multiple 0.9 m (3 ft.) drops to tile.
Electrostatic Discharge (ESD)	+/-15kVdc air discharge, +/-8kVdc direct discharge, +/-2kVdc indirect discharge
Sealing	IP54
Wireless LAN Data Communications	
Wireless Local Area Network (WLAN) radio	IEEE® 802.11a/b/g/n/r with internal antenna
Data Rates Supported	802.11b: 1, 2, 5.5, 11 Mbps 802.11a/g: 6, 9, 12, 18, 24, 36, 48, 54 Mbps 802.11n: 6.5, 13, 19.5, 26, 39, 52, 58.5, 65 Mbps 802.11n with SGI: 7.2, 14.4, 21.7, 28.9, 43.3, 57.8, 65, 72.2 Mbps Fast Roam: Pre-Authentication, PMKID Caching, Opportunistic Key Caching (OKC), Cisco CCKM, Zebra HFSR, 802.11r Certifications: Wi-Fi, CCXv4
Operating Channels	Chan 36 - 165 (5180 – 5825 MHz), Chan 1 - 13 (2412 - 2472 MHz); actual operating channels/frequencies depend on regulatory rules and certification agency.
Security	Security Modes: Legacy, WPA and WPA2 Encryption: WEP (40 and 128 bit), TKIP and AES Authentication: TLS, TTLS (MSCHAP), TTLS (MSCHAPV2), TTLS (PAP), PEAP (MSCHAPV2), PEAP (GTC), FAST (MSCHAPV2), FAST (GTC), LEAP. CCXv4 certified.
Spreading Technique	Direct Sequence Spread Spectrum (DSSS) and Orthogonal Frequency Division Multiplexing (OFDM)
Wireless PAN Data and Voice Communications	
Bluetooth	Class II, v 2.1 with EDR; integrated antenna.
Data Capture	

Table continued...

Item	Description
Imager	Captures 1D and 2D bar codes.
Rear-facing Camera	For bar code scanning and image capture: 8 MP auto-focus camera with aiming; captures 1D and 2D bar codes, photographs, video, signatures and documents.
Magnetic Stripe Reader	Reads data on magnetic stripe cards.
RS507 Hands-free Imager	Captures 1D and 2D bar codes.
Sensors	
Motion Sensor	3-axis accelerometer that enables motion sensing applications for dynamic screen orientation and power management.
Ambient Light/Proximity Sensor	Automatically adjusts display brightness and turns off the display during PTT calls.
Imager (SE4500-DL) Specifications	
Field of View	Horizontal - 39.2° Vertical - 25.4°
Optical Resolution	WVGA 752 H x 480 V pixels (gray scale)
Roll	360°
Pitch Angle	+/- 60° from normal
Skew Tolerance	+/- 60° from normal
Ambient Light	Indoor: 450 ft. candles (4845 lux) Outdoor: 9000 ft. candles (96,900 lux) Sunlight: 8000 ft. candles Fluorescent: 450 ft. candles
Focal Distance	From center of exit window: 18.5 cm (7.3 in.)
Aiming Element (VLD)	655 nm +/- 10 nm
Illumination Element (LED)	625 nm +/- 5 nm
Supported Symbologies	
1D	Chinese 2 of 5, Codabar, Code 11, Code 128, Code 39, Code 93, Discrete 2 of 5, EAN-8, EAN-13, GS1 DataBar, GS1 DataBar Expanded, GS1 DataBar Limited, Interleaved 2 of 5, Korean 2 of 5, MSI, TLC 39, Matrix 2 of 5, Trioptic, UPCA, UPCE, UPCE1, Web Code.
2D	Australian Postal, Aztec, Canadian Postal, Composite AB, Composite C, Data Matrix, Dutch Postal, Japan Postal, Maxicode, Micro PDF, Micro QR, PDF, QR Code, UK Postal, US Planet, US Postnet, US4State, US4State FICS.

Single-Slot Charge Cradle CRDMC40XX-1000R Technical Specifications

Table 17: Single-slot Charge Cradle Technical Specifications

Item	Description
Dimensions	Height: 69.4 mm (2.73 in.) Width: 102.5 mm (4.04 in.) Depth: 88.9 mm (3.50 in.)
Weight	274 g (9.67 oz)
Input Voltage	5 VDC
Power Consumption (with MC40)	6 watts
Operating Temperature	0 °C to 40 °C (32 °F to 104 °F)
Storage Temperature	-40 °C to 70 °C (-40 °F to 158 °F)
Charging Temperature	0 °C to 40 °C (32 °F to 104 °F)
Humidity	0% to 95% non-condensing
Drop	76.2 cm (30.0 in.) drops to vinyl tiled concrete at room temperature.
Electrostatic Discharge (ESD)	+/- 15 kV air +/- 8 kV contact

Five-Slot Charge Only Cradle CRDUNIV-40-5000R Technical Specifications

Table 18: Five-Slot Charge Only Cradle Technical Specifications

Item	Description
Dimensions (Base only)	Height: 40.2 mm (1.6 in.) Width: 449.6 mm (17.7 in.) Depth: 120.3 mm (4.7 in.)
Dimensions (Base with five Charging Cups)	Height: 90.1 mm (3.5 in.) Width: 449.6 mm (17.7 in.) Depth: 120.3 mm (4.7 in.)
Dimensions (Base with four Charging Cups and one Battery Charger Cup)	Height: 77.0 mm (3.0 in.) Width: 449.6 mm (17.7 in.)

Table continued...

Item	Description
	Depth: 120.3 mm (4.7 in.)
Weight (Base only)	0.93 kg (20.5 lbs.)
Weight (Base with five Charging Cups)	1.31 kg (2.89 lbs.)
Weight (Base with four Charging Cups and one Battery Charger Cup)	1.30 kg (2.86 lbs.)
Input Voltage	12 VDC
Power Consumption (with MC40)	37.5 watts
Operating Temperature	0 °C to 50 °C (32 °F to 122 °F)
Storage Temperature	-40 °C to 70 °C (-40 °F to 158 °F)
Charging Temperature	0 °C to 40 °C (32 °F to 104 °F)
Humidity	0% to 95% non-condensing
Drop	76.2 cm (30.0 in.) drops to vinyl tiled concrete at room temperature.
Electrostatic Discharge (ESD)	+/- 15 kV air +/- 8 kV contact

Four-Slot Battery Charger SACMC40XX-4000R Technical Specifications

Table 19: Four-slot Battery Charger Technical Specifications

Item	Description
Dimensions (with USB Host Expansion Module)	Height: 59.9 mm (2.36 in.) Width: 84.0 mm (3.31 in.) Depth: 116.3 mm (4.58 in.)
Weight	257 g (9.07 in.)
Input Voltage	12 VDC
Power Consumption (with MC40)	25 watts
Operating Temperature	0 °C to 40 °C (32 °F to 104 °F)
Storage Temperature	-40 °C to 70 °C (-40 °F to 158 °F)
Charging Temperature	0 °C to 40 °C (32 °F to 104 °F)
Humidity	0% to 95% non-condensing
Drop	76.2 cm (30.0 in.) drops to vinyl tiled concrete at room temperature.

Table continued...

Item	Description
Electrostatic Discharge (ESD)	+/- 15 kV air
	+/- 8 kV contact

Index

A

adaptive frequency hopping [63](#)
 albums [74](#)
 android version [11](#)
 application shortcuts [31](#)
 approved cleanser [88](#)

B

back button [16](#)
 battery
 charging [18](#)
 management [21](#)
 replacement [20](#)
 bluetooth
 connecting to a device [66](#)
 profiles [67](#)
 Bluetooth
 PIN [63](#)
 security [63](#)
 build number [11](#)

C

camera
 rear-facing [17](#)
 camera settings [72](#)
 cleaning [88](#)
 cleaning instructions [88](#)
 configuration [11](#)
 cradle
 connector cleaning [89](#)
 creating folders [32](#)

D

datawedge [59](#)
 decode mode [49](#)
 default notifications [25](#)
 digital camera [49](#)
 display
 cleaning [89](#)

F

file browser [42](#)
 five-slot charge only cradle base [79](#)
 four slot battery charger [79](#)

H

harmful ingredients [88](#)
 home button [16](#)

K

keyboard [34](#)

L

light sensor [15](#)

M

memory [11](#)
 menu button [16](#)
 micro USB cable [79](#)
 microphone [15](#)

N

naming folders [32](#)

O

operating system [11](#)

P

panoramic [70](#)
 photos [69](#)
 picklist mode [49](#)
 power button [16](#)
 power on [19](#)

R

radios [11](#)
 recording videos [71](#)
 replacing the battery [20](#)
 resetting [41](#)
 right LED [16](#)
 rotate screen [23](#)
 RS507 scanning [52](#)

S

scan angle [50](#)
 scanning range [50](#)
 screen lock sounds [25](#)
 screen rotation [23](#)
 screen timeout [24](#)
 serial number [11](#)
 service information [13](#)
 set date [22](#)
 set time [22](#)
 set time zone [22](#)
 setting
 camera [72](#)
 video [72](#)

single-slot charge only cradle [79](#)
soft reset [41](#)
spare battery [80](#)
status bar [28](#)
system sounds [25](#)

T

taking a panoramic photo [70](#)
taking photos [69](#)
touch screen [16](#)

V

vibrate on touch [25](#)
video settings [72](#)
videos [69](#), [71](#)
volume [24](#)



Zebra Technologies Corporation
Lincolnshire IL, U.S.A.
<http://www.zebra.com>

Zebra and the Zebra head graphic are registered trademarks of ZIH Corp. The Symbol logo is a registered trademark of Symbol Technologies, Inc., a Zebra Technologies company.

© 2015 Symbol Technologies, Inc.

