

MC45 USER GUIDE

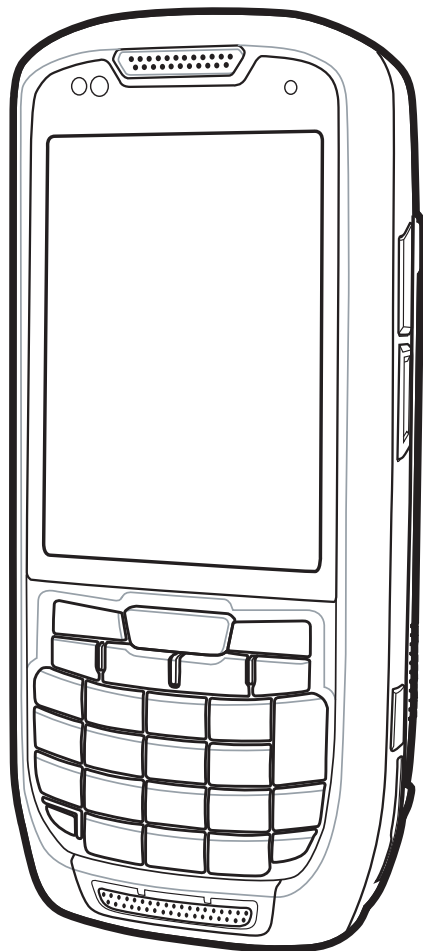

MC45
User Guide

72E-164159-02

Rev. A

February 2015

No part of this publication may be reproduced or used in any form, or by any electrical or mechanical means, without permission in writing from Zebra. This includes electronic or mechanical means, such as photocopying, recording, or information storage and retrieval systems. The material in this manual is subject to change without notice.

The software is provided strictly on an “as is” basis. All software, including firmware, furnished to the user is on a licensed basis. Zebra grants to the user a non-transferable and non-exclusive license to use each software or firmware program delivered hereunder (licensed program). Except as noted below, such license may not be assigned, sublicensed, or otherwise transferred by the user without prior written consent of Zebra. No right to copy a licensed program in whole or in part is granted, except as permitted under copyright law. The user shall not modify, merge, or incorporate any form or portion of a licensed program with other program material, create a derivative work from a licensed program, or use a licensed program in a network without written permission from Zebra. The user agrees to maintain Zebra’s copyright notice on the licensed programs delivered hereunder, and to include the same on any authorized copies it makes, in whole or in part. The user agrees not to decompile, disassemble, decode, or reverse engineer any licensed program delivered to the user or any portion thereof.

Zebra reserves the right to make changes to any software or product to improve reliability, function, or design.

Zebra does not assume any product liability arising out of, or in connection with, the application or use of any product, circuit, or application described herein.

No license is granted, either expressly or by implication, estoppel, or otherwise under any Zebra intellectual property rights. An implied license only exists for equipment, circuits, and subsystems contained in Zebra products.

Zebra Technologies Corporation
Lincolnshire, IL U.S.A
<http://www.zebra.com>

Revision History

Changes to the original manual are listed below:

Change	Date	Description
-01 Rev. A	12/2012	Initial release.
-01 Rev. B	1/2013	Edited installation instructions and illustrations for Vehicle Charge Cradle.
-02 Rev. A	2/2015	Zebra Rebranding

Table of Contents

Revision History	iii
------------------------	-----

About This Guide

Introduction	xi
Documentation Set	xi
Configurations	xii
Software Versions	xii
Chapter Descriptions	xiv
Notational Conventions	xv
Related Documents	xv
Service Information	xvi

Chapter 1: Getting Started

Introduction	1-1
Unpacking	1-2
Getting Started	1-2
Installing the Micro Secure Digital (microSD) Card	1-3
Installing the mini-SIM Card	1-4
Installing the Battery	1-5
Charging the Battery	1-6
Charging the Battery	1-6
Charging Spare Batteries	1-7
Charging Temperature	1-7
Powering On the MC45	1-8
Calibrating the Screen	1-8
Checking Battery Status	1-8
Replacing the Battery	1-8
First-time Network Activation	1-9
GSM/UMTS Activation	1-9
Network Activation	1-9
Battery Management	1-10
Changing the Power Settings	1-10
Changing the Backlight & Keylight Settings	1-10

Turning Off the Radios	1-10
------------------------------	------

Chapter 2: Using the MC45

Introduction	2-1
Home Screen	2-1
Status Bar	2-2
Icon Bar	2-4
Today Screen	2-5
Classic Today Screen	2-6
Soft Keys Bar	2-8
Start Screen	2-8
Settings Folder	2-11
Adjusting Volume	2-14
Battery Status Indications	2-15
LED Indicators	2-16
Resetting the MC45	2-17
Waking the MC45	2-17
Locking the MC45	2-17
Password Locking	2-18
Function Buttons	2-20
Stylus	2-21
Entering Data	2-21
Display Orientation	2-22
Taking Photos	2-23
Recording Video	2-23
Viewing Photos and Videos	2-23

Chapter 3: Data Capture

Introduction	3-1
Laser Scanning	3-1
Scanning Considerations	3-1
Bar Code Scanning	3-2
Adaptive Scanning	3-2
Color Digital Camera	3-3
Digital Camera Scanning	3-3
DataWedge	3-4

Chapter 4: Using the Phone

Introduction	4-1
Accessing the Phone Dialer	4-1
Turning the Phone On and Off	4-2
Using a Bluetooth Headset	4-3
Adjusting Audio Volume	4-4
Using the Phone Keypad	4-5
Using Contacts	4-5
Using Call Log	4-6
Making a Speed Dial Call	4-7
Making an Emergency Call	4-7

Answering a Call	4-7
Incoming Call Features	4-8
Smart Dialing	4-8
Muting a Call	4-9
Using Speed Dial	4-10
Adding a Speed Dial Entry	4-10
Editing a Speed Dial Entry	4-12
Deleting a Speed Dial Entry	4-12
Using Call Log	4-13
Managing Call Log	4-13
Changing the Call Log View	4-13
Deleting All Call Log Items	4-14
Viewing Call Status	4-15
Using the Call Log Options	4-16
SMS Messaging	4-20
Sending a Text Message	4-20
Viewing Text Messages	4-21
Replying to a Text Message	4-22
MMS Messaging	4-22
Creating and Sending MMS Messages	4-23
Viewing an MMS Message	4-23
Replying to an MMS Message	4-24
Blocking Incoming MMS Messages	4-24
Voice Commander	4-24
Call	4-25
Find	4-26
Redial	4-26
Callback	4-26
Start	4-27
Appointments	4-27
Read	4-27
What time is it	4-27
Call History	4-27
Voice Play Music	4-27
What can I say	4-28
Goodbye	4-28

Chapter 5: Using WLAN

Introduction	5-1
Fusion Overview	5-1
Connecting to the Internet	5-2
Wireless Zero Config Overview	5-2
Switching Between Fusion and WZC	5-2
Supported Applications	5-3
Wireless Zero Config Setup	5-6
More Information on WZC	5-8

Chapter 6: Using GPS Navigation

Introduction	6-1
--------------------	-----

Software Installation	6-1
MC45 GPS Setup	6-1
Operation	6-2
GPS Maps on microSD Cards	6-2
Answering a Phone Call While Using GPS	6-2
Losing the GPS Signal While in a Vehicle	6-2
GPS Reset	6-3

Chapter 7: Using Bluetooth

Introduction	7-1
Adaptive Frequency Hopping	7-1
Security	7-2
Bluetooth Power States	7-3
Suspend	7-3
Resume	7-3
Turning Bluetooth On and Off	7-4
Enabling Bluetooth	7-4
Discovering Bluetooth Device(s)	7-5
Available Services	7-8
Object Push Services via Beam	7-8
Internet Sharing	7-9
Hands-free Services	7-10
Serial Port Services	7-11
ActiveSync Using Serial Port Services	7-11
Phone Book Access Profile Services	7-13
Dial-Up Networking Services	7-13
Connect to a HID Device	7-14
A2DP/AVRCP Services	7-14

Chapter 8: Accessories

Introduction	8-1
Communication with Host Computer	8-3
Charging the MC45 Battery	8-4
Charging Temperature	8-5
Vehicle Charge Cradle	8-6
Windshield Installation	8-6
Install the MC45	8-7
Connect Power	8-8
Remove the MC45	8-9
Battery Charging Indicators	8-10
Charging Temperature	8-10
micro USB Adapter	8-11
Installing ActiveSync	8-13
MC45 Setup	8-13
Setting Up an ActiveSync Connection on the Host Computer	8-14
Synchronization with the MC45	8-14

Chapter 9: Maintenance & Troubleshooting

Introduction	9-1
Maintaining the MC45	9-1
Removing the Screen Protector	9-2
Battery Safety Guidelines	9-3
Cleaning	9-3
Materials Required	9-3
Cleaning the MC45	9-4
Housing	9-4
Display	9-4
Scanner Exit Window	9-4
Connector	9-4
Cleaning Cradle Connectors	9-4
Cleaning Frequency	9-5
Troubleshooting	9-5
MC45	9-5
Single Slot Charge Cradle	9-8
Multi Slot Universal Charge Only Cradle	9-9
Vehicle Charge Cradle	9-9
Four Slot Battery Charger	9-10
Cables	9-11

Appendix A: Technical Specifications

MC45 Technical Specifications	A-1
MC45 Accessory Specifications	A-4
Single Slot Charge Cradle	A-4
Multi Slot Universal Charge Only Cradle	A-5
Four Slot Battery Charger	A-6

Appendix B: Keypads

Numeric Keypad Configuration	B-1
Special Character Key	B-4

Glossary**Index**

About This Guide

Introduction

This guide provides information about using the MC45 and accessories.

✓ **NOTE** Screens and windows pictured in this guide are samples and can differ from actual screens.

Documentation Set

The documentation set for the MC45 provides information for specific user needs, and includes:

- **MC45 Quick Start Guide** - describes how to get the MC45 up and running.
- **MC45 User Guide** - describes how to use the MC45.
- **MC45 Integrator Guide** - describes how to set up the MC45 and accessories.
- **MC45 Regulatory Guide** - provides all regulatory, service and EULA information for the MC45.
- **Enterprise Mobility Developer Kit (EMDK) Help File** - provides API information for writing applications.

Configurations

This guide covers the following configurations:

Configuration	Radios	Display	Memory	Data Capture	Operating System	Keypads
MC4587	WWAN: GSM/HSDPA	3.2" QVGA16 Bit Color	256 MB RAM/ 1 GB Flash	Camera	Microsoft Windows Embedded Handheld 6.5.3, Professional Edition	Numeric
MC4597	WLAN: 802.11a/b/g WWAN: GSM/HSDPA	3.2" QVGA16 Bit Color	256 MB RAM/ 1 GB Flash	1-D laser scanner or camera	Microsoft Windows Embedded Handheld 6.5.3, Professional Edition	Numeric

Software Versions

This guide covers various software configurations and references are made to operating system or software versions for:

- Adaptation Kit Update (AKU) version
- OEM version
- Phone version
- Fusion version

AKU Version

To determine the Adaptation Kit Update (AKU) version:

Tap **Start > Settings > System** folder > **About** icon > **Version** tab.



The second line lists the operating system version and the build number. The last part of the build number represents the AKU number. *Build 29102.5.3.12.13* indicates that the device is running AKU version 5.3.12.13.

OEM Version

To determine the OEM software version:

Tap **Start** > **Settings** > **System** folder > **System Info** icon > **System** tab.

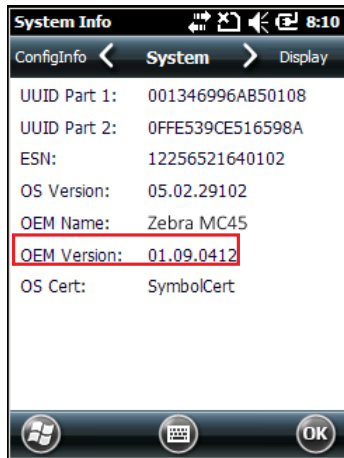

Fusion Software

To determine the Fusion software version:

Tap **Start** > **Wireless Companion** icon > **Wireless Status** icon > **Versions**.

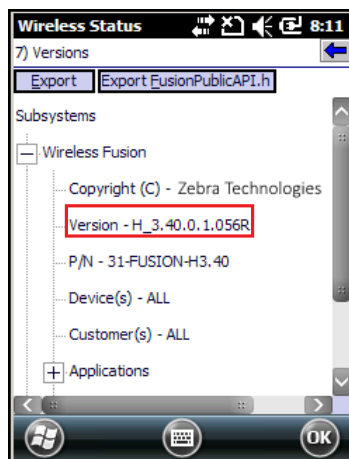

Phone Software

To determine the Phone software version:

Tap **Start** > **Phone** >  > **Phone information**.

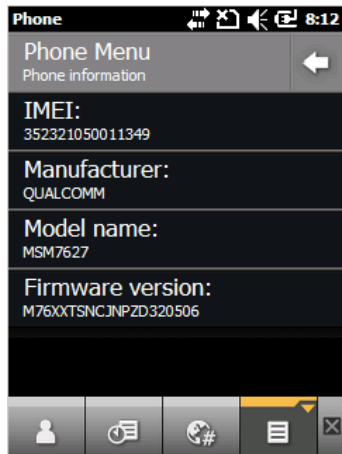

Chapter Descriptions

Topics covered in this guide are as follows:

- [Chapter 1, Getting Started](#) provides information on getting the MC45 up and running for the first time.
- [Chapter 2, Using the MC45](#) provides basic instructions for using the MC45, including powering on and resetting the MC45, and entering and capturing data.
- [Chapter 3, Data Capture](#) provides information for using the MC45 to capture data using the laser scanner or camera.
- [Chapter 4, Using the Phone](#) provides basic instructions for using the MC45 phone.
- [Chapter 5, Using WLAN](#) explains the WLAN functionality on the MC45.
- [Chapter 6, Using GPS Navigation](#) provides information about GPS navigation with the MC45.
- [Chapter 7, Using Bluetooth](#) explains Bluetooth functionality on the MC45.
- [Chapter 8, Accessories](#) describes the available accessories and how to use them with the MC45.
- [Chapter 9, Maintenance & Troubleshooting](#) includes instructions on cleaning and storing the MC45, and provides troubleshooting solutions for potential problems during MC45 operation.
- [Appendix A, Technical Specifications](#) provides the technical specifications for the MC45.
- [Appendix B, Keypads](#) provides keypad layouts and operation.

Notational Conventions

The following conventions are used in this document:

- “Mobile Computer” refers to the Zebra MC45 series of handheld computers.
- *Italics* are used to highlight the following:
 - Chapters and sections in this and related documents
 - Icons on a screen.
- **Bold** text is used to highlight the following:
 - Dialog box, window, and screen names
 - Drop-down list and list box names
 - Check box and radio button names
 - Key names on a keypad
 - Button names on a screen.
- Bullets (•) indicate:
 - Action items
 - Lists of alternatives
 - Lists of required steps that are not necessarily sequential
- Sequential lists (e.g., those that describe step-by-step procedures) appear as numbered lists.

Related Documents

- *MC45 Quick Start Guide*, p/n 72-164157-xx.
- *MC45 Regulatory Guide*, p/n 72-164158-xx.
- *MC45 Integrator Guide*, p/n 72E-164160-xx.
- *Enterprise Mobility Developer Kits (EMDKs)*, available at: <http://www.zebra.com/support>.
- Latest ActiveSync software, available at: <http://www.microsoft.com>.

For the latest version of this guide and all guides, go to: <http://www.zebra.com/support>.

Service Information

If you have a problem with your equipment, contact Zebra Global Customer Support for your region. Contact information is available at: <http://www.zebra.com/support>.

When contacting Zebra Global Customer Support, please have the following information available:

- Serial number of the unit
- Model number or product name
- Software type and version number

Zebra responds to calls by email, telephone or fax within the time limits set forth in support agreements.

If your problem cannot be solved by Zebra Global Customer Support, you may need to return your equipment for servicing and will be given specific directions. Zebra is not responsible for any damages incurred during shipment if the approved shipping container is not used. Shipping the units improperly can possibly void the warranty.

If you purchased your Zebra business product from a Zebra business partner, contact that business partner for support.

Chapter 1 Getting Started

Introduction

This chapter lists the parts for the MC45 and explains how to install and charge the batteries, replace the strap, and power on the MC45 for the first time.

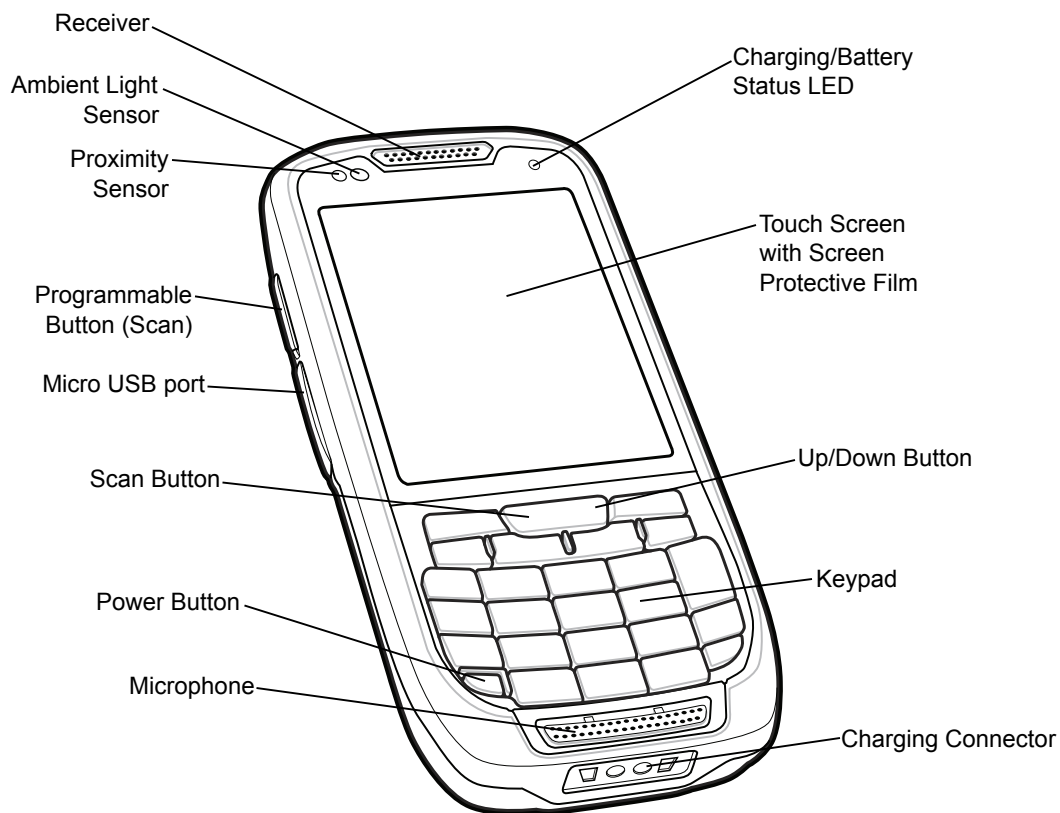

Figure 1-1 MC45 Front View

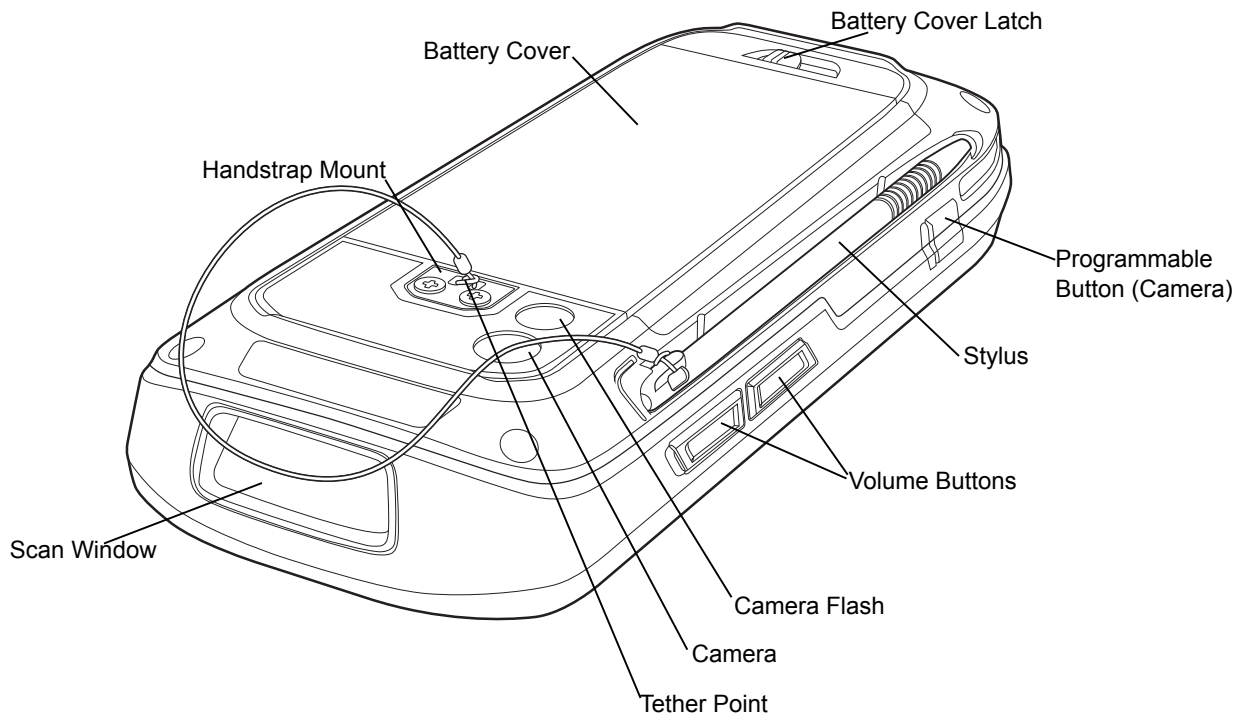

Figure 1-2 MC45 Rear View

Unpacking

Carefully remove all protective material from the MC45 and save the shipping container for later storage and shipping.

Verify that you received the following:

- MC45
- Lithium-ion battery
- Battery cover
- Tethered stylus
- Screen Protector
- Regulatory Guide
- Quick Start Guide.

Inspect the equipment for damage. If any equipment is missing or damaged, contact the Zebra Global Customer Support center immediately. See [page xvi](#) for contact information.

Getting Started

To start using the MC45 for the first time:

- Install microSD card (optional)

- Install the mini-SIM card
- Install the battery.
- Charge the MC45
- Power on the MC45
- Configure the MC45.

Installing the Micro Secure Digital (microSD) Card

The microSD card slot provides secondary non-volatile storage. The slot is located under the battery (see [Figure 1-3](#)). Refer to the documentation provided with the card for more information, and follow the manufacturer's recommendations for use.



CAUTION Follow proper ESD precautions to avoid damaging the microSD card. Proper ESD precautions include, but are not limited to, working on an ESD mat and ensuring that the operator is properly grounded.

To install the microSD card:

1. Slide the mini-SIM card holder to the right to unlock.
2. Lift the mini-SIM card holder.

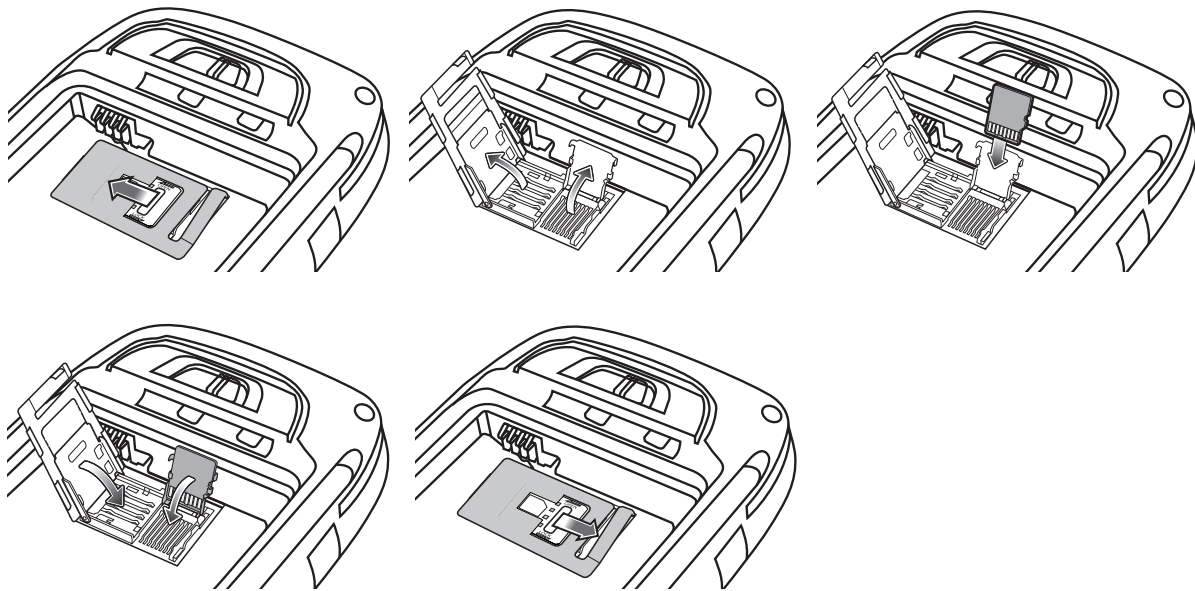

Figure 1-3 *microSD Card Installation*

3. Slide the microSD card holder down to unlock.
4. Lift up the microSD card holder.
5. Insert the card with the card contacts facing down and lower the microSD card holder.
6. Slide the microSD card holder up to lock.
7. Lower the mini-SIM card holder.
8. Slide the mini-SIM card holder to the left to lock.

To remove the microSD card:

1. Slide the microSD card holder down to unlock.
2. Lift the microSD card holder.

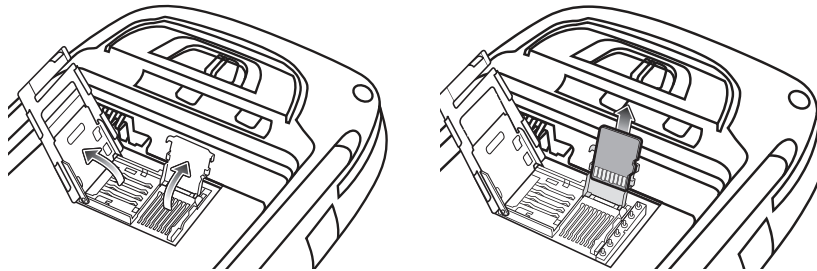

Figure 1-4 Card Removal

3. Remove the card from the card holder.
4. Lower the microSD card holder.
5. Slide the microSD card holder up to lock.

Installing the mini-SIM Card

- ✓ **NOTE** The MC45 does not support copying multiple contacts to some SIM cards. If an error message appears, see [Chapter 9, Maintenance & Troubleshooting](#) for more information.

GSM phone service requires a Subscriber Identification Module (SIM) card, or smart card. Obtain this card from the your service provider. The card fits into the MC45 and can contain the following information:

- Mobile phone service provider account details.
- Information regarding service access and preferences.
- Contact information, which can be moved to **Contacts** on the MC45.
- Any additional services to which you have subscribed.

- ✓ **NOTE** For more information about SIM cards, refer to the service provider's documentation.

To install the mini-SIM card:

1. Slide the mini-SIM card holder to the right to unlock.
2. Lift the mini-SIM card holder.

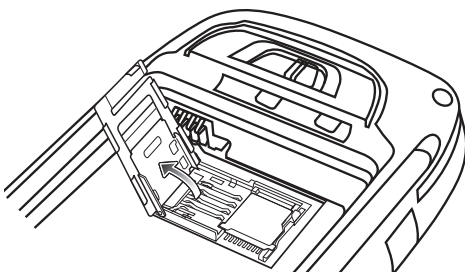

Figure 1-5 Lifting the mini-SIM Card Cover

3. Insert the mini-SIM card, as shown in [Figure 1-6](#), with the cut edge of the card facing out and the contacts facing down.

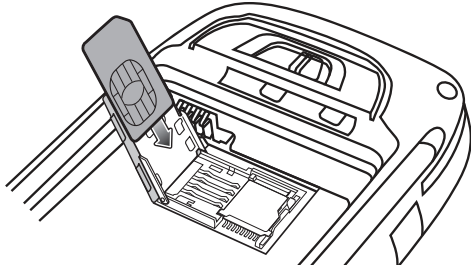

Figure 1-6 Inserting the mini-SIM Card

4. Lower the mini-SIM card holder and slide it to the left to lock.
5. Install the battery. See [Installing the Battery on page 1-5](#) for more information.
6. After completing initial MC45 setup or after replacing a mini-SIM card:
 - a. Press the red **Power** button.
 - b. Ensure **Phone** is on.
 - c. Make a call to verify cellular connection.

✓ **NOTE** For detailed information about WWAN activation and settings, refer to the *MC45 Integrator Guide*.

Installing the Battery

✓ **NOTE** When installing the battery for the first time out of the box, the back cover and battery are not installed.

To install the battery:

1. Insert the battery, bottom first, into the battery compartment in the back of the MC45.

✓ **NOTE** Position the battery correctly, with the battery gold charging contacts positioned on top of the gold charging pins in the MC45 battery compartment.

2. Press the battery down into the battery compartment.

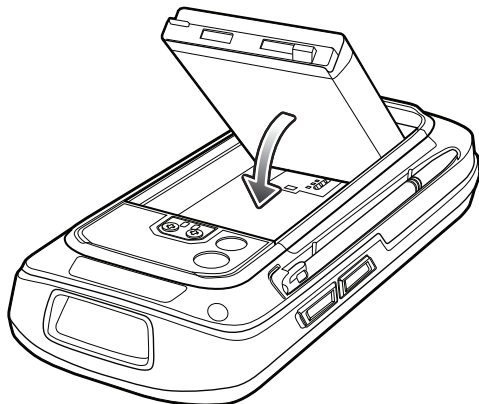

Figure 1-7 *Inserting the Battery*

3. With the battery cover latch open, insert the cover, top first, then press down on the bottom of the cover.
4. Slide the battery cover latch to the right until the red dot is not visible.

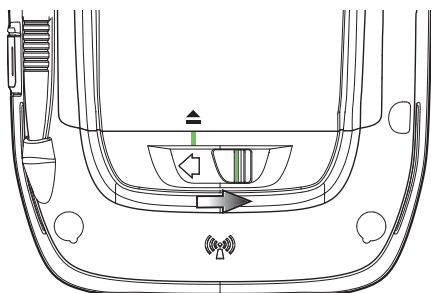

Figure 1-8 *Locking the Battery Cover Latch*

5. Power up the MC45 by pressing the red **Power** button.

Charging the Battery



CAUTION Ensure that you follow the guidelines for battery safety described in [Battery Safety Guidelines on page 9-3](#).

Charging the Battery

Before using the MC45 for the first time, charge the main battery until the green Charging/Battery Status LED remains lit (see [Table 1-1 on page 1-7](#) for charge status indications). To charge the MC45, use the USB Rapid Charge Cable or a cradle with the appropriate power supply. For information about the accessories available for the MC45, see [Chapter 8, Accessories](#).

To charge the battery, use either a USB Rapid Charge Cable or a cradle. For USB Rapid Charge Cable or cradle setup and charging procedures refer to the *MC45 Integrator Guide*.

- Single Slot Charge Cradle
- Multi Slot Universal Charge Only Cradle
- Vehicle Charge Cradle.

To charge the battery:

1. Connect the charging accessory to the appropriate power source.
2. Insert the MC45 into a cradle or attach to the USB Rapid Charge Cable and Power Supply. The MC45 begins charging. The Charging/Battery Status LED blinks green while charging, then turns solid green when fully charged. See [Table 1-1](#) for charging indications.
3. The 3080mAh battery fully charges in less than six hours at room temperature of approximately 25 °C (77°F). Charging time may vary at different temperatures.

✓ **NOTE** The MC45 Battery Cover must be in place and closed properly for the MC45 to power on and charge the battery.

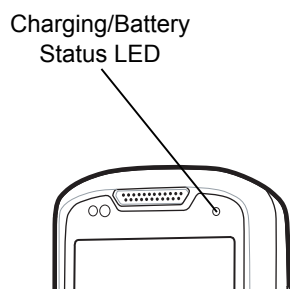

Figure 1-9 LED Indicators

Table 1-1 LED Charge Indications

Charging/Battery Status LED	Indication
Off	MC45 is not charging. MC45 is not inserted correctly in the cradle or connected to a power source. Cradle is not powered.
Slow Blinking Green (1 blink every 2 seconds)	MC45 is charging.
Solid Green	Charging complete.
Fast Blinking Red (2 blinks / second)	Charging error, e.g.: <ul style="list-style-type: none"> • Temperature is too low or too high. • Charging has gone on too long without completion (typically eight hours).

Charging Spare Batteries

See [Chapter 8, Accessories](#) for information on using accessories to charge spare batteries.

Charging Temperature

Charge batteries in temperatures from 0°C to 40°C (32°F to 104°F). Charging is intelligently controlled by the MC45.

To accomplish this, for small periods of time, the MC45 or accessory alternately enables and disables battery charging to keep the battery at acceptable temperatures. The MC45 or accessory indicates when charging is disabled due to abnormal temperatures via its LED. See [Table 1-1](#).

Powering On the MC45

Press the **Power** button to turn on the MC45. If the MC45 does not power on perform a reset. See [Resetting the MC45 on page 2-17](#).

When turning the MC45 on for the first time, the splash screen displays for about a minute as the MC45 initializes its flash file system, then the calibration window appears. Note that these windows also appear upon reset.

Calibrating the Screen

✓ **NOTE** The Calibration screen can be accessed by pressing **Blue** key - **BKSP** key or tapping **Start > Settings > System > Screen > General > Align Screen** button.

To calibrate the screen so the cursor on the touch screen aligns with the tip of the stylus:

1. Remove the stylus from its holder on the back of the MC45.
2. Tap the screen to begin calibration.
3. Carefully press and briefly hold the tip of stylus on the center of each target that appears on the screen.
4. Repeat as the target moves around the screen.

Checking Battery Status

To check the charge status of the main battery or backup battery in the MC45, tap **Start > Settings > Power** icon to display the **Power** window.

Replacing the Battery

To replace the battery:

1. Press the red **Power** button to wake the device.
2. Hold down the red **Power** button for 3 seconds and release. A screen appears. Tap the **Power Off** to turn off the MC45.
3. Slide the battery cover latch to the left until the green indicators align with the eject icon and the red dot is visible. The battery cover ejects slightly.

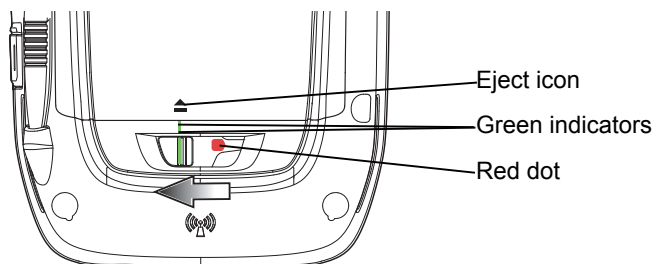

Figure 1-10 *Unlocking the Battery Cover Latch*

4. Lift the bottom of the battery cover and remove.
5. Lift the battery, top first, out of the well.



CAUTION Do not attempt to remove the battery using a screwdriver or sharp instrument.

6. Insert the replacement battery, bottom first, into the battery compartment in the back of the MC45.



NOTE Position the battery correctly, with the battery gold charging contacts positioned on top of the gold charging pins in the MC45 battery compartment.

7. With the battery cover latch open, insert the cover, top first, then press down on the bottom of the cover.

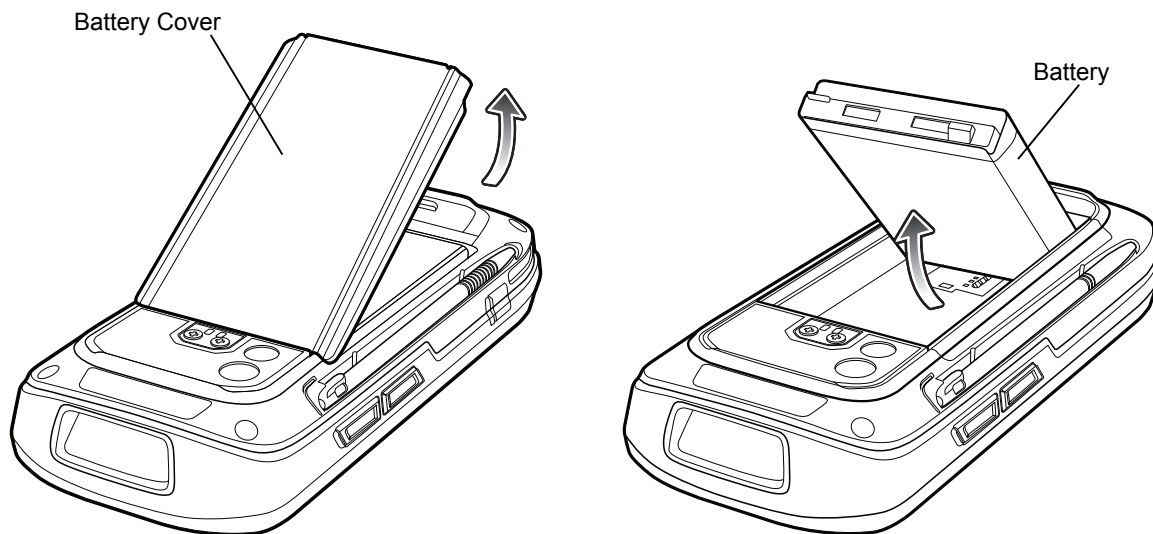

Figure 1-11 Replacing the Battery

8. Slide the battery cover latch to the right until the red dot is not visible.
9. Press the red **Power** button to power on the MC45.

First-time Network Activation

GSM/UMTS Activation

Network Activation

To activate on a GSM/UMTS network:

1. If an active SIM card was installed in the MC45, the MC45 performs the activation process.
2. The **Phone Network - GSM/UMTS Setup** dialog box displays.
3. Tap **Yes** and then **OK**. For some carriers, the MC45 resets.
4. If during start-up, no update connection settings message appears, tap **Start > Settings > Connections > Phone Network Setup** and tap **Update Connection Settings** button.
5. If the network is unsupported, a message appears with links for manually setting the data connection and MMS settings.

For detailed information for configuring the phone and activating on a different network, refer to the *MC45 Integrator Guide*.

Battery Management

Observe the following battery saving tips:

✓ **NOTE** The MC45 factory default settings for the WLAN radio is set to OFF.

- Leave the MC45 connected to AC power at all times when not in use.
- Set the MC45 to turn off after a short period of non-use.
- Set the backlight to turn off after a short period of non-use.
- Turn off all wireless activities when not in use.
- Power off the MC45 when charging to charge at a faster rate.

Changing the Power Settings

To set the MC45 to turn off after a short period of non-use:

1. Tap **Start > Settings > Power icon > Advanced tab**.
2. Select the **On battery power: Turn off screen if not used for** check box and select a value from the drop-down list.
3. Select **ok**.

Changing the Backlight & Keylight Settings

To change the backlight settings in order to conserve more battery power:

1. Tap **Start > Settings > System tab > Backlight & Keylight icon > Battery Power tab**.
2. Select the **Disable backlight if device is not used for** check box and select a value from the drop-down list.
3. Select the **Brightness tab**.
4. Tap the **Disable backlight** check box to turn off the display backlight, or use the slider to set a low value for the backlight.
5. Select **ok**.

Turning Off the Radios

Windows Embedded Handheld 6.5 devices include **Wireless Manager**, which provides a simple method of enabling, disabling, and configuring all the device's wireless capabilities in one place.

To open **Wireless Manager**, tap **Status Bar > Connectivity icon > Wireless Manager** on the **Today** screen.



Figure 1-12 Tapping the Connectivity Icon

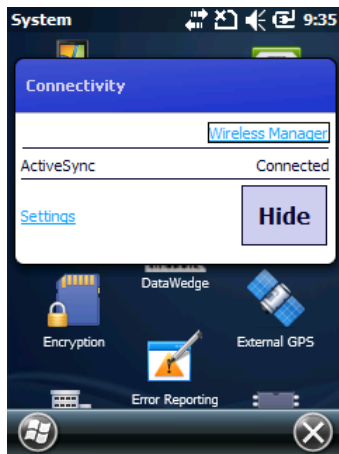

Figure 1-13 Opening Wireless Manager

Select **Wireless Manager**.



Figure 1-14 *Wireless Manager Window*

✓ **NOTE** Wireless connection options vary depending upon configurations.

To enable or disable a wireless connection, tap the specific button.

To enable or disable all wireless connections, tap the **All** button.

To configure settings for a connection, tap **Menu**.

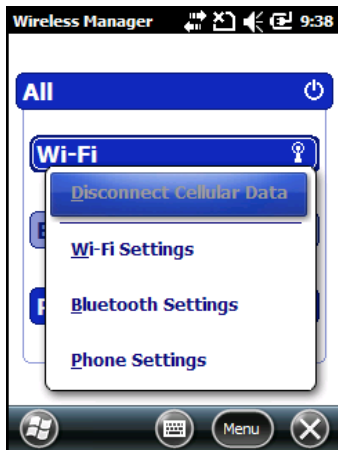

Figure 1-15 *Wireless Manager Menu*

Chapter 2 Using the MC45

Introduction

✓ **NOTE** The WLAN feature is only applicable for the MC4597.

This chapter explains the buttons, status icons, and controls on the MC45, and provides basic instructions for using the MC45, including powering on and resetting the MC45, and entering and capturing data.

The MC45 factory default radio states are:

- WLAN - OFF
- Bluetooth - OFF
- Phone - ON.

Home Screen

The Home contains the Status Bar at the top of the screen, the Today screen in the center and the Soft Keys at the bottom of the screen.

Each of these are described below.



Figure 2-1 Home Screen

Status Bar

The Status Bar at the top of the screen can contain the status icons listed in [Table 2-1](#).



Table 2-1 Status Icons

Icon	Description
Notifications	
	Notification that one or more instant messages were received.
	Notification that one or more e-mail/text messages were received.
	Notification that one or more voice messages were received.
	Speakerphone is on.
	There are more notification icons than can be displayed. Tap to display remaining icons.
	Indicates a reminder of an upcoming calendar event.
	One or more Email messages were received.
	Receiving MMS message.
	Sending MMS message.
	MMS message sent successfully.

Table 2-1 Status Icons (Continued)











































Icon	Description
	MMS message received successfully.
	Bluetooth is on.
	TTY Headset enabled.
	TTY HCO enabled.
	TTY VCO enabled.
	Microsoft customer feedback alert.
Connectivity	
	Connection is active.
	Connection is not active.
	Synchronization is occurring.
	WLAN available.
	WLAN in use.
	HSDPA available.
	3G available.
	GPRS available.
	EGPRS available.
	Call missed.
WAN	
	Dialing while no SIM card is installed.
	Voice call in progress.
	Calls are forwarded.
	Call on hold.
	Antenna/signal icon: wireless on/good signal.
	Antenna/signal icon: wireless off.
	Antenna/signal icon: no service or searching.
	HSDPA connecting.
	HSDPA in use.
	3G connecting.
	3G in use.
	GPRS connecting.
	GPRS in use.

Table 2-1 *Status Icons (Continued)*

Icon	Description
	EGPRS connecting.
	EGPRS in use.
	Roaming.
	SIM Card not installed.
Audio	
	All sounds are on.
	All sounds are off.
	Vibrate is on.
Battery	
	Battery is charging.
	Battery has a full charge.
	Battery has a high charge.
	Battery has a medium charge.
	Battery has a low charge.
	Battery has a very low charge.

Icon Bar

Tap the Status Bar to display the icon bar. Tap an icon to get additional notification or status information.

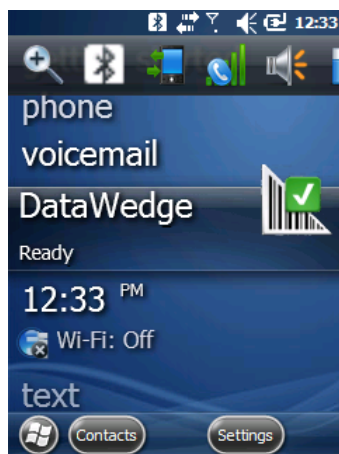











**Figure 2-2** *Icon Bar*

Table 2-2 Bar Icons

Icon	Name	Description
	Magnify	Enlarges the screen.
	Bluetooth	Displays the Bluetooth dialog box.
	WLAN	Displays the Network Detection dialog box.
	Voicemail	Dials Voicemail.
	Notifications	Indicates that notifications are available.
	Headset	Indicates that a wireless stereo headset is connected to the MC45.
	Connectivity	Displays the Connectivity dialog box.
	Phone Data	Displays the Phone dialog box.
	Volume	Displays the Volume dialog box.
	Power	Displays the Power window.
	Clock & Alarms	Opens the Clock & Alarms window.

Today Screen

The Today screen is scrollable and contains a list of applications and an Information Status bar. The Information Status bar highlights the application that is under it and provides additional information.

Touch and hold the screen with your finger and move the Today screen up and down. As the application names move under the Information Status bar, information relevant to that application appears in the bar.

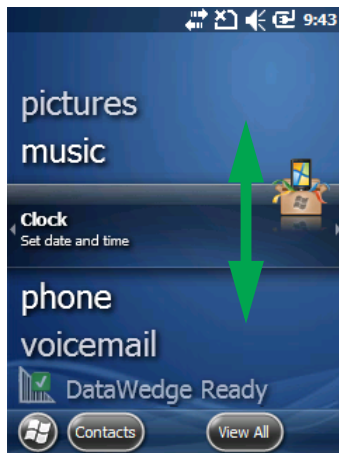

Figure 2-3 Moving Today Screen

You can also touch and hold the Information Status bar and move it up and down over an application name. Remove your finger and the Information Status bar and application name center in the screen.

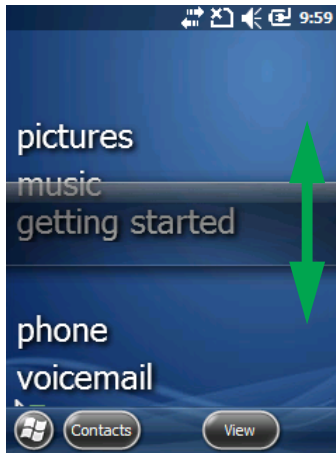

Figure 2-4 Moving Information Status Bar

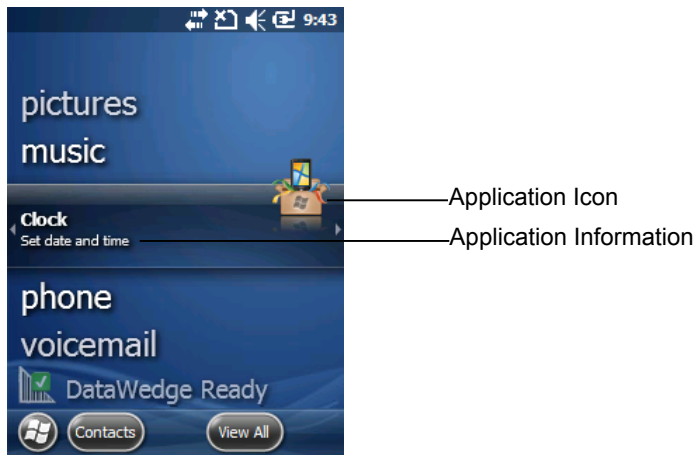

Figure 2-5 Information Bar Example

To customize the **Today** screen, tap **Start > Settings > Today** icon. Use the **Appearance** tab to customize the background and the **Items** tab to change the display format.

Classic Today Screen

The user can change the Today screen to the classic layout that is used in Windows Mobile 6.5.3.

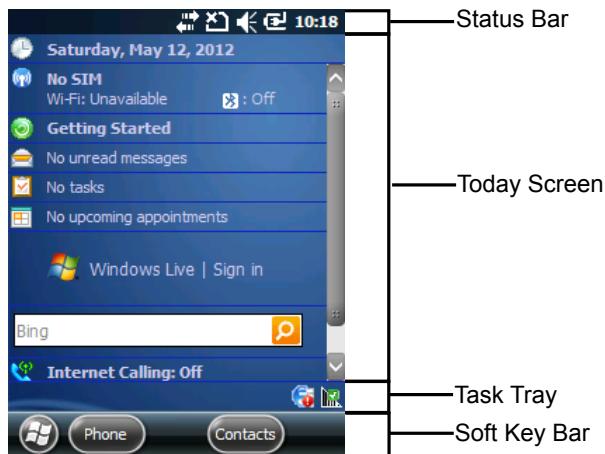

Figure 2-6 Classic Today Screen

To change to the classic view tap **Start > Settings > Home icon > Items** tab.

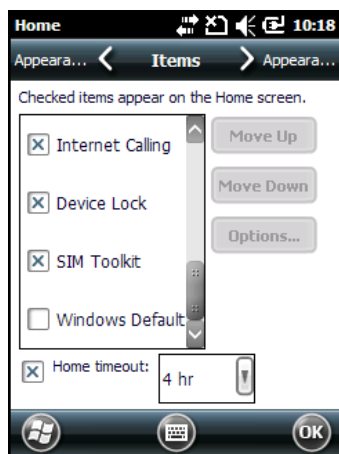

Figure 2-7 Today Screen Settings

Deselect the **Windows Default** checkbox and select any of the other checkboxes.

Tap **OK**.

✓ **NOTE** The task bar is only visible in the classic view.

The task bar at the bottom of the screen can contain the task tray icons listed in [Table 2-3](#).

Table 2-3 Task Tray Icons

Icon	Name	Description
	Wireless connection status	Indicates WLAN signal strength.
	ActiveSync	Active serial connection between the MC45 and the host computer.
	DataWedge	Provides access to the DataWedge interface.

Soft Keys Bar

The Soft Key bar is located at the bottom of the screen and contains two soft key buttons. These buttons display an action and a menu to the user that are context sensitive and can be changed dynamically by an application. For example, in the Contacts list view, the soft keys are **New** and **Menu**. As the user begins creating a new contact in edit view, the soft keys change to **Done** and **Menu**.

Start Screen

The Start screen lists applications and folders available to the user. [Table 2-4](#) lists the default programs and folders listed on the **Start** screen.

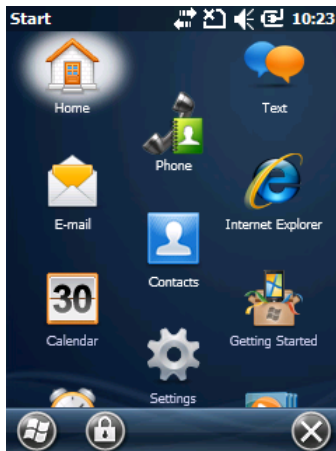

Figure 2-8 Start Screen

Table 2-4 Programs and Folders on the Start Screen











Icon	Name	Description	Icon	Name	Description
	Today	Close the Start menu and display the Today screen.		E-mail	Send an Email.
	Text	Send an SMS text message.		Contacts	Keep track of friends and colleagues.
	Calendar	Keep track of appointments and create meeting requests.		Internet Explorer	Browse Web and WAP sites as well as download new programs and files from the Internet.
	Settings	Open the Settings folder. See Settings Folder on page 2-11 .		Pictures & Videos	View and manage pictures, animated GIFs, and video files.
	Getting Started	Launch the Getting Started application.		Windows Media	Play back audio and video files.

Table 2-4 Programs and Folders on the Start Screen (Continued)



























Icon	Name	Description	Icon	Name	Description
	Messenger	Use this mobile version of Windows Live Messenger.		Marketplace	Purchase applications from the Marketplace.
	Phone	Make and receive calls, switch between calls, and set up conference calling.		MSN Weather	Check the local weather.
	Windows Live	Use this mobile version of Windows Live™ to find information on the web.		MSN Money	Keep track of your finances.
	Games	Play games.		Remote Desktop	Log onto Windows NT server type computers and use all of the programs that are available on that computer from the MC45.
	Notes	Create handwritten or typed notes, drawings, and voice recordings.		Calculator	Perform basic arithmetic and calculations, such as addition, subtraction, multiplication, and division.
	Tasks	Keep track of your tasks.		File Explorer	Organize and manage files on your device.
	ActiveSync	Synchronize information between the MC45 and a host computer or the Exchange Server.		Office Mobile	Use the complete suite of Microsoft® Office applications for your mobile device. Excel Mobile OneNote Mobile PowerPoint Mobile Word Mobile
	Internet Sharing	Connect a notebook computer to the Internet using the MC45's data connection.		Task Manager	Enables viewing of memory and CPU allocations and stops running processes. Refer to the <i>Microsoft Applications for Windows Embedded Handheld 6.5.3 User Guide</i> for more information.
	Search Phone	Search contacts, data, and other information on the MC45. Refer to the Microsoft Applications for Windows Embedded Handheld 6.5.3 User Guide for more information.		Wireless Companion	Open the Wireless Companion folder.









Table 2-4 Programs and Folders on the Start Screen (Continued)

Icon	Name	Description	Icon	Name	Description
	Help	See Help topics for the current screen or program.		AirBEAM Client	Allows specially designed software packages to be transferred between a host server and the MC45. Refer to the <i>MC45 Integrator Guide</i> for more information.
	SMS Staging	Intercepts SMS Staging messages and reassembles them into the original Staging Profile.		MSP Agent	Interacts with MSP agents to collect monitoring and asset information to enable the configuration, provisioning, monitoring and troubleshooting of the MC45. Refer to the <i>MC45 Integrator Guide</i> for more information.
	Rapid Deployment Client	Facilitates software downloads from a Mobility Services Platform Console FTP server to the MC45. Refer to the <i>MC45 Integrator Guide</i> for more information.		DEMO	Launches the DEMO applications. This icon appears after the DEMO applications have been installed.
	Alarms	Sets the clock to the date and time of your locale. Alarms can also be set at specified days and times of a week.		Toolbox	Contains the Adobe Reader , Streaming Player and Voice Commander applications.
	Debug	Contains the RIL Logger and RTLogExport applications. Use when instructed to by Zebra support personnel.			

Settings Folder

Table 2-5 lists the setting applications pre-installed on the MC45. Tap **Start > Settings** to open the **Settings** folder.

Table 2-5 Setting Applications in the Setting Folder

Icon	Name	Description	Icon	Name	Description
	Clock & Alarms	Set the device clock to the date and time of your locale or to a visiting time zone when you're traveling. Alarms can also be set at specified days and times of a week.		Power	Check battery power and set the time-out for turning off the display to conserve battery power.
	Lock	Set a password for the MC45.		Sounds & Notifications	Enable sounds for events, notifications, and more, and set the type of notification for different events.
	Connections Folder	Contains connection applications (see below).		Home	Customize the appearance of the Today screen and the information to display on it.
	Personal Folder	Contains personal applications (see below).		Bluetooth	Open the Bluetooth application, set the MC45 to visible mode and scan for other Bluetooth devices in the area.
	System Folder	Contains system applications (see below).			

Connections Folder







	Beam	Set the MC45 to receive incoming IrDA beams.		Connections	Set up one or more types of modem connections for your device, such as phone dial-up, GPRS, Bluetooth, and more, so that your device can connect to the Internet or a private local network.
	Domain Enroll	Make your device an AD domain member for device management and security. Refer to the <i>Microsoft Applications for Windows Mobile 6 User Guide</i> for more information.		GPS Assist	Helps to find your MC45 location faster.
	Phone Network Setup	Activate the phone and setup the network.		USB Connect	Enables or disables the enhanced network connectivity.

Table 2-5 *Setting Applications in the Setting Folder (Continued)*

























Icon	Name	Description	Icon	Name	Description
	WLAN	Setup wireless network connection and customize settings.		Wireless Manager	Enables or disables the MC45's wireless radios and customizes WLAN, and Bluetooth settings.
Personal Folder					
	Buttons	Assign a program to a button.		Owner Information	Enter personal information on the MC45.
	Input	Set options for each of the input methods.		Phone	Configure phone settings.
	KeyRemap	Remap the keys in the hard keypad.		Voice Commander Settings	Enable user to use speech commands on the MC45.
System Folder					
	About	View basic information such as the Windows Mobile® version and type of processor used on the MC45.		Certificates	See information about certificates installed on the MC45.
	Backlight & Keylight	Set the display backlight and keylight time-out and adjust brightness.		Customer Feedback	Submit feedback on the Windows Mobile 6 software.
	Error Reporting	Enable or disable the device's error reporting function. When this function is enabled and a program error occurs, technical data about the state of the program and your computer is logged in a text file and delivered to Microsoft's technical support if you choose to send it.		Encryption	Allow files on a storage card to be encrypted. Encrypted files are readable only on your device.
	DataWedge	Enable or disable the barcode scanning function.		Device Information	Display the MC45 hardware information.

Table 2-5 *Setting Applications in the Setting Folder (Continued)*

Icon	Name	Description	Icon	Name	Description
	External GPS	Set the appropriate GPS communication ports, if required. You may need to do this when there are programs on the device that access GPS data or you have connected a GPS receiver to the device.		Managed Programs	Displays the programs that were installed on the MC45 using Mobile Device Manager.
	Task Manager	Stop running programs.		Memory	Check the device memory allocation status and memory card information and stop currently running programs.
	Regional Settings	Set the regional configuration to use, including the format for displaying numbers, currency, date, and time on the MC45.		Remove Programs	Remove programs that you installed on the MC45.
	System Info	Displays the MC45's software and hardware information.		Screen	Change the screen orientation, re-calibrate the screen, and change the screen text size.

Adjusting Volume

To adjust the system volume using the **Speaker** icon in the navigation bar:

1. Tap the **Speaker** icon. The **Volume** dialog box appears.

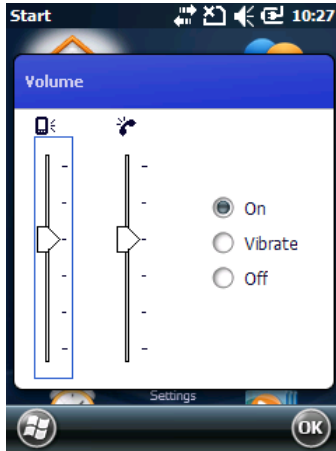

Figure 2-9 *Volume Dialog Box*

2. Tap and move the slide bar to adjust the volume.
3. Select the **On** or **Off** radio button to turn the volume on or off.

You can also adjust the system volume using the **Sounds & Notifications** window, or use the **Up/Down** button on the side of the MC45.

Battery Status Indications

Battery icons appear on the navigation bar indicating the battery power level. When the battery power falls below a predetermined level the icon indicates the status and a battery dialog box appears indicating the status of the battery.

The **Battery** icon always appears in the **navigation bar** when the Today screen is visible. The icon indicates the battery power level. The message displays until the **Dismiss** button is pressed.



Figure 2-10 *Battery Icon on the Title Bar*

Also view the battery status using the **Power** window.

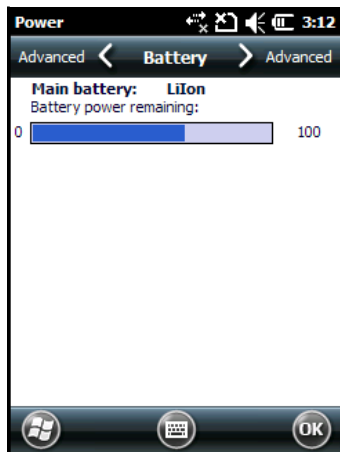

Figure 2-11 *Battery Status.*

LED Indicators

The MC45 has one LED indicator. The Charging/Battery Status LED indicates battery charging and status.

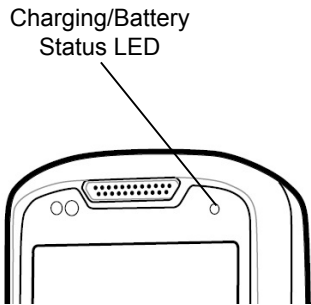

Figure 2-12 LED Indicators

Table 2-6 LED Indications

LED State	Indication
Charging/Battery Status LED	
Slow Blinking Green	Battery in MC45 is charging.
Solid Green	Battery in MC45 is fully charged.
Fast Blinking Red	Charging error.
Off	Not charging.
Single Blink Green (when Power button pressed)	Start-up commenced.

- ✓ **NOTE** During an over temperature error condition, the Charging Error indication will only appear if the condition exists for more than 30 minutes.
- ✓ **NOTE** For information about scanning/decoding, see [Chapter 3, Data Capture](#). For information about WAN radio status and settings, see [Chapter 4, Using the Phone](#), or refer to the *MC45 Integrator Guide*.

Resetting the MC45

To perform a reset simultaneously press the **Power** button and the **1** and **9** keys.

Waking the MC45

The wake-up conditions define what actions wake up the mobile computer after it has gone into suspend mode. The mobile computer can go into suspend mode by either pressing the Power button or automatically by Control Panel time-out settings. These settings are configurable and the factory default settings are shown in are subject to change/update. To change the wake-up conditions, tap **Start > Settings > Power > Wakeup**.

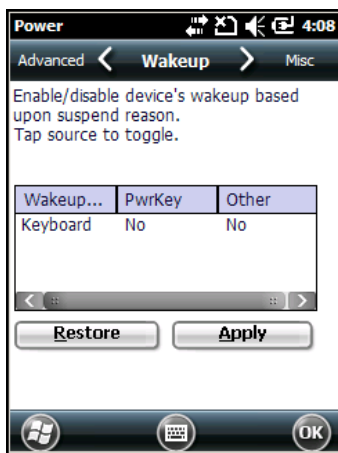

Figure 2-13 Wake-up Device Window

Locking the MC45

✓ **NOTE** You can make emergency calls even when the MC45 is locked.

Use the Device Lock feature to prevent use of the device. Note that when locked, the MC45 does not respond to screen or keypad input.

To lock the MC45, tap **Start > Lock** or press the **Power** button for three seconds and then tap **Lock Device**. The **Lock** screen appears.

To unlock the MC45, slide the **Lock** button to the left or right.

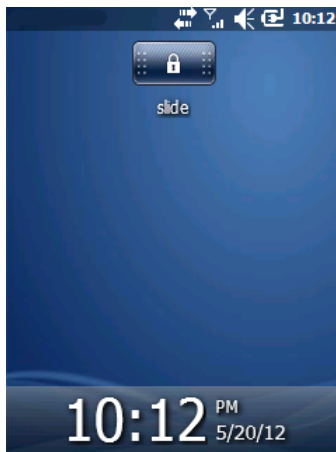

Figure 2-14 *Unlock Device Window*

If the MC45 was locked with a password, a prompt appears for the password.

Password Locking

Use the **Password** window to set a password to disable unauthorized access to the MC45.

- ✓ **NOTE** If the device is configured to connect to a network, use a strong (difficult to figure out) password to help protect network security. Password cracking tools continue to improve and the computers used to crack passwords are more powerful than ever.

1. Tap **Start > Settings > Lock icon > Password** tab.

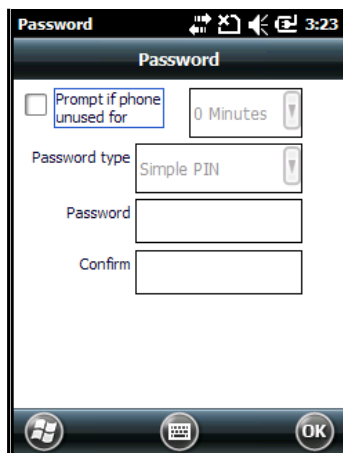

Figure 2-15 *Password Window - Password Tab*

2. Select **Prompt if device unused for** check box to enable password protection.
3. From the drop-down list, select a time value for the protection to take affect after non-use.
4. From the **Password type:** drop-down list, select either **Simple PIN** or **Strong alphanumeric**.
5. For a simple password, enter a four-digit password in the **Password** field.
For a stronger password:

- a. Enter a seven character password in the **Password:** field. A strong password must contain at least seven characters and contain at least three of the following: uppercase and lowercase letters, numerals, and punctuation.
 - b. Re-enter the password in the **Confirm:** field.
6. Tap **OK**.
 7. To set a hint to remember the password, tap the **Hint** tab.
 8. In the text box, enter a hint for a password reminder.
 9. Tap **OK**.

✓ **NOTE** You can make emergency calls even when the MC45 is password locked.

When the MC45 is not used for a period of time and the user tries to access the device, the Password window appears. This also appears when the MC45 is connected to a host computer with either a cradle or communication cable.

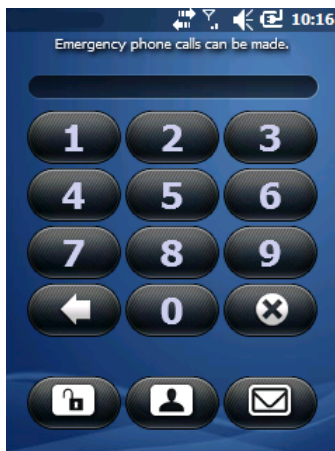

Figure 2-16 *Enter Password Windows*

Enter the password to un-lock the device.

Tap the **Unlock** button to unlock the device and go to the Today screen, or tap the **Contact** button to unlock the device and go to the Contacts window or tap the **Email** button to unlock the device and go to the **Messaging** window.

Function Buttons

The MC45's buttons perform certain functions.

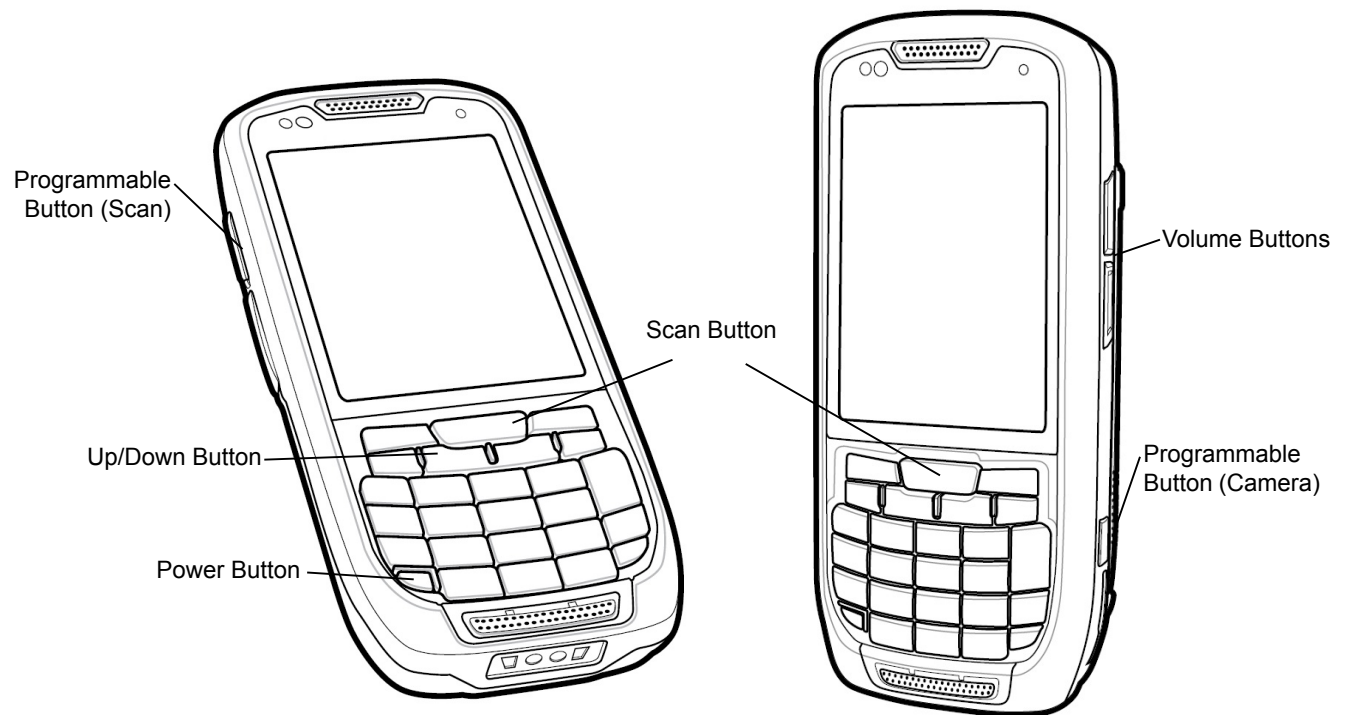

Figure 2-17 *Function Buttons*

- **Power:** Press the red **Power** button to turn the MC45 screen on and off. The MC45 is in suspend mode when the screen is off. For more information, see [Powering On the MC45 on page 1-8](#). Also use the **Power** button to reset the MC45 by performing a warm or cold boot. See [Resetting the MC45 on page 2-17](#).
- **Scan:** Press to scan bar codes or capture images. See [Chapter 3, Data Capture](#).
Or, press to open an application or perform a function. See the *Microsoft® Applications for Windows Embedded Handheld 6.5 User Guide* to set an application to open.
- **Up/Down:** Press to increase or decrease the MC45's volume.

Stylus

Use the MC45 stylus to select items and enter information. The stylus functions as a mouse.

- Tap: Touch the screen once with the stylus to press option buttons and open menu items.
- Tap and Hold: Tap and hold the stylus on an item to see a list of actions available for that item. On the pop-up menu that appears, tap the action to perform.
- Drag: Hold the stylus on the screen and drag across the screen to select text and images. Drag in a list to select multiple items.



CAUTION To prevent damage to the screen, do not use any device other than the Zebra-provided stylus.

Entering Data

When entering data on the keypad, use either the single-hand method or the two-hand method as shown in [Figure 2-18](#).

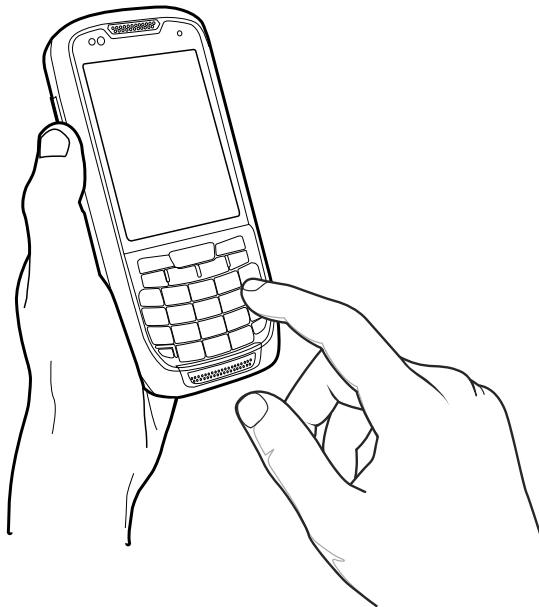

Single-hand Method

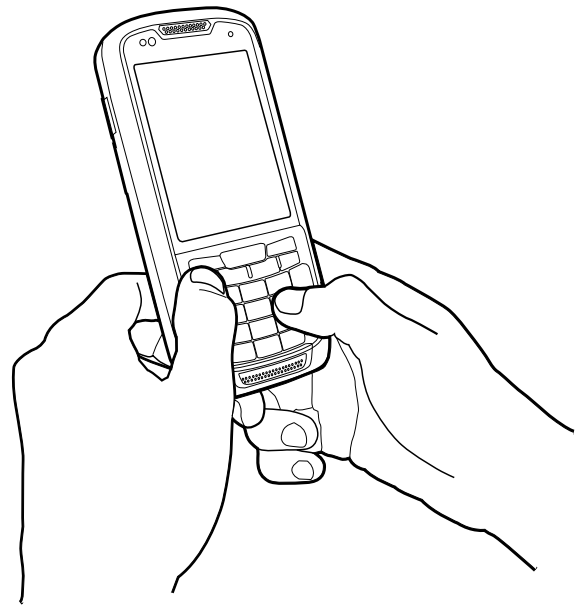

Two-hand Method

Figure 2-18 *Entering Data on the Keypad*

Display Orientation

The screen can be rotated between portrait and landscape modes manually. To change the orientation of the screen, tap **Start > Settings > System > Screen > General** tab and select between three different types of orientations:

- Portrait
- Landscape (right-handed)
- Landscape (left-handed).

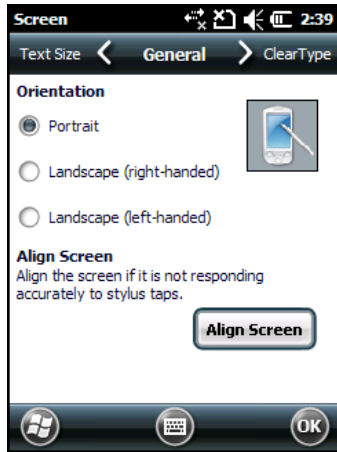

Figure 2-19 *Display Orientation Window*

Taking Photos

To take a photo:

1. Press the side Camera button or tap **Start > Pictures & Videos** and then tap **Camera** on the Command bar.
2. Check the image on the view finder, adjust if necessary.
3. Press the side Camera button or the ENTER key to take the picture. Hold the MC45 still until the camera flash occurs or the shutter sound is heard.

Recording Video

To record a video clip:

1. Press the side Camera button or tap **Start > Pictures & Videos** and then tap **Camera** on the Command bar.
2. Tap **Camera** on the command bar.
3. Tap **Menu > Video** to set shooting mode to video.

The available recording time displays on the screen.



NOTE By default, the time limit for recording videos is set to 30 seconds.

4. Press the **OK** key or the side **Camera Button** to begin recording.
Recording stops when you press the **OK** key or the side **Camera Button** again.

Viewing Photos and Videos

To view photos and video clips:

1. Tap **Start > Pictures & Videos** icon.
2. Tap the picture or video clip to view.

Chapter 3 Data Capture

Introduction

The MC45 offers two types of data capture options:

- Laser scanning
- Color digital camera.

The MC45 contains the **DataWedge** application that allows user to enable the camera, decode the bar code data and display the bar code content. To enable **DataWedge**, see [DataWedge on page 3-4](#).

Laser Scanning

An MC45 with an integrated laser scanner has the following features:

- Reading of a variety of bar code symbologies, including the most popular 1-D code types.
- Intuitive aiming for easy point-and-shoot operation.
- Adaptive Scanning.

Scanning Considerations

Typically, scanning is a simple matter of aim, scan, and decode and a few quick trial efforts master it. However, consider the following to optimize scanning performance:

- Range

Any scanning device decodes well over a particular working range — minimum and maximum distances from the bar code. This range varies according to bar code density and scanning device optics.

Scanning within range brings quick and dependable decodes; scanning too close or too far away prevents decodes. Move the scanner closer or further away to find the right working range for the bar codes being scanned.

- Angle

Scanning angle is important for promoting quick decodes.

- Hold the MC45 farther away for larger symbols.
- Move the MC45 closer for symbols with bars that are close together.



NOTE Scanning procedures depend on the application and MC45 configuration. An application may use different scanning procedures from the one listed above.

Bar Code Scanning



CAUTION Do not aim the scan beam at your eyes and others.

1. Ensure that a scan-enabled application is loaded on the MC45.

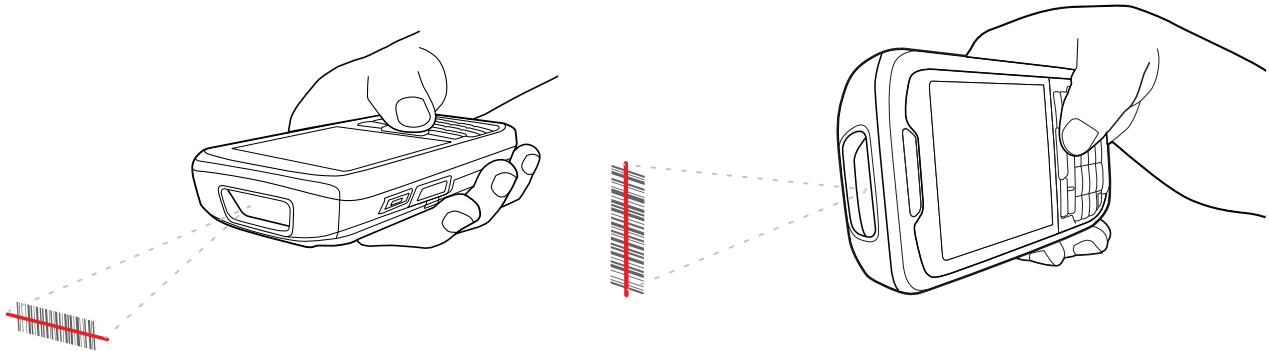

Figure 3-1 *Linear Scanning*

2. Press and hold the scan button. The laser beam exits from the end of the MC45. Ensure the red scan beam covers the entire bar code. The Scan/Decode LED lights red to indicate that scanning is in process, then lights green and a beep sounds, by default, to indicate the bar code was decoded successfully.



Figure 3-2 *Linear Scanner Aiming Pattern*

3. Release the scan button.

Adaptive Scanning

The MC45 contains the adaptive scanning feature that automatically adjusts the scan beam width for rapid and easy scanning of bar codes from near contact to more than 200 inches away.

By default the MC45 is set to wide scan beam width. When the user presses the scan button, the MC45 determines the distance from the bar code. For close bar codes the MC45 sets a wide beam width and for far bar codes it sets a narrow beam width. The MC45 uses distance, bar code type and material to determine the correct scan beam width.

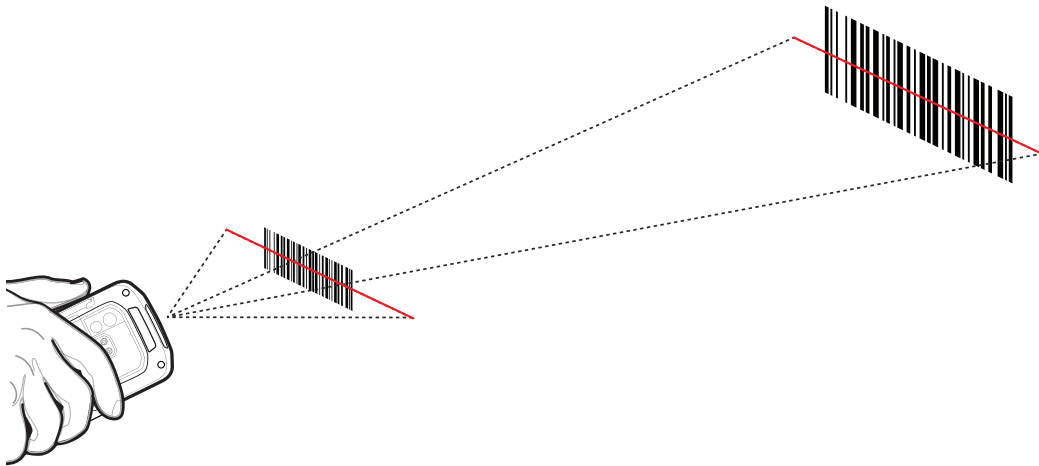

Figure 3-3 Adaptive Scanning

Color Digital Camera

MC45 with an integrated color digital camera have the following features:

- Omnidirectional reading of a variety of bar code symbologies, including the most popular linear, postal, PDF417, and 2D matrix code types.
- Advanced intuitive aiming for easy point-and-shoot operation.

Digital Camera Scanning

1. Ensure that a scan-enabled application is loaded on the MC45.
2. Aim the camera lens on the back of the MC45 at a bar code.
3. Press and hold the scan button. In the image window, align the camera over the barcode.

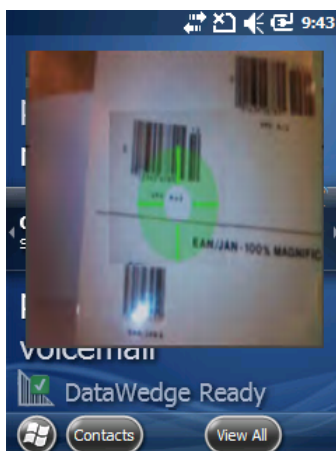

Figure 3-4 Digital Camera Scanning

4. The Scan/Decode LED lights green and a beep sounds, by default, to indicate the bar code was decoded successfully. Release the scan button.



NOTE The camera decode feature is set by default to automatically decode the bar code when read. This feature can be programmed to display a red aiming reticle that turns green upon good decode indicating that the bar code has been successfully decoded and to that the scan button may be released.

DataWedge

DataWedge allows the user to input captured bar code data into a text field of an application.

To enable **DataWedge**:

1. Tap **Start > Settings > System > DataWedge**.
2. Tap **Basic Configuration**.
3. Tap **1. Barcode input**.
4. Select one of the following
 - a. Tap **1. SSI Scanner Driver** for the laser scanner.
 - b. Tap **2. Camera Scanner Driver** for the camera.
5. Tap **1. Enabled**.
6. Tap **0. Back**.
7. Tap **0. Back**.
8. Tap **0. Exit**.
9. Tap **OK**.
10. Tap the **Running** option to start the DataWedge process. The DataWedge Status changes to **Ready**.
11. Tap **OK**.

To disable **DataWedge**:

1. Tap **Start > Settings > System > DataWedge**.
2. Tap the **Running** option to end the DataWedge process. The DataWedge Status changes to **Stopped**.
3. Tap **OK**.

Chapter 4 Using the Phone

Introduction

Use the MC45 to make phone calls, set up speed dials, keep track of calls, and send text messages. Your wireless service provider may also provide other services such as voice mail, call forwarding, and caller ID.

Also use the integrated phone to connect to an ISP or work network in order to browse the Web and read e-mail. Connect to the Internet or work network over High-Speed Downlink Packet Access (HSDPA) using Cellular Line, or using the modem specified by the mobile operator. For more information, or to customize the MC45 phone by changing phone settings, see the *MC45 Integrator Guide*.

Accessing the Phone Dialer

- ✓ **NOTE** Dialers vary depending on the carrier, services and the state of the phone. For example, place calls on hold and use  to create conference calls. (See [Conference Calling on an MC45 on page 4-17.](#))

Access the dialer regardless of the program in use. Applications on the MC45 can be in use during a call.

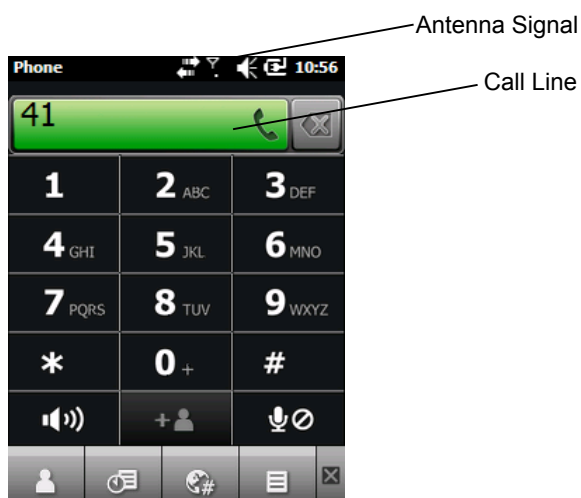

Figure 4-1 Phone Dialer

To access the phone dialer tap **Start > Phone** or press  .

To receive calls when the MC45 is suspended, leave the phone radio turned on and ensure the MC45 is set to wake with any key.

Turning the Phone On and Off

Windows Embedded Handheld 6.5 devices include **Wireless Manager**, which provides a simple method of enabling and disabling the phone.

To open **Wireless Manager**, tap the **Connectivity** icon.

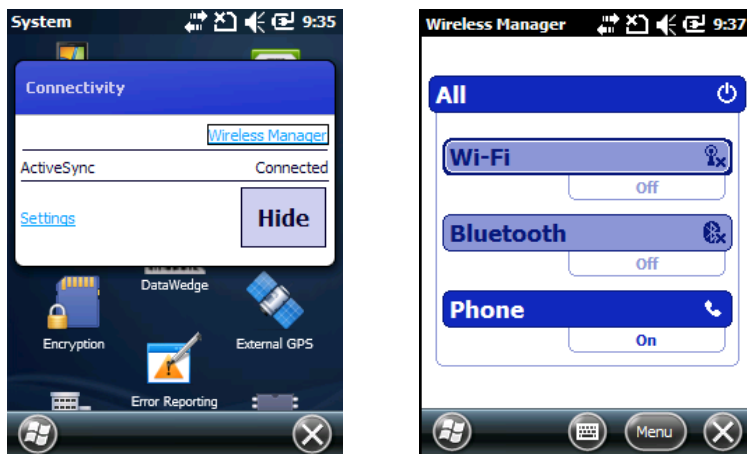

Figure 4-2 *Opening Wireless Manager*

Select **Wireless Manager**. The **Wireless Manager** window appears.

To toggle on or off the phone, tap blue Phone bar.

To configure settings for a connection, tap **Menu > Phone Settings**.

Audio Modes

The MC45 offers three audio modes for use during phone calls:

- **Handset Mode:** Switches audio to the speaker at the top front of the MC45, so you can use the MC45 as a handset. This is the default mode.
- **Speaker Mode:** Use the MC45 as if on speaker phone. Tap the **Speaker On** button to activate this mode. Tap the **Speaker Off** button to switch back to handset mode.
- **Headset Mode:** Connect a Bluetooth headset to automatically switch audio to the headset.

The MC45 defaults to handset mode. When a Bluetooth headset is configured for use with the MC45, the earpiece and speakerphone are muted and audio is heard through the headset.

✓ **NOTE** While using a Bluetooth headset during a call, the mobile computer will not go into suspend mode.



Figure 4-3 Audio Modes

Using a Bluetooth Headset

You can use a Bluetooth headset for audio communication when using an audio-enabled application. See [Chapter 7, Using Bluetooth](#) for information on connecting a Bluetooth headset to the MC45. Set the MC45's volume appropriately before putting the headset on. When a Bluetooth headset is connected the speakerphone is muted.

It is recommended for phone conversations to use the Bluetooth Hands-free profile instead of the Headset profile. See [Chapter 7, Using Bluetooth](#) for more information.

✓ **NOTE** When using a Bluetooth headset during a call, the MC45 power button is disabled and the MC45 will not go into suspend mode. Once the call is completed, the power button functionality is enabled.

The following dialog box displays when a Bluetooth headset connection is established.



Figure 4-4 WWAN Bluetooth Audio Notification Dialog Box

Adjusting Audio Volume

Use the Volume Control Slider or the keypad keys to adjust the volume of the ringer when not in a call and the audio volume when in a call.

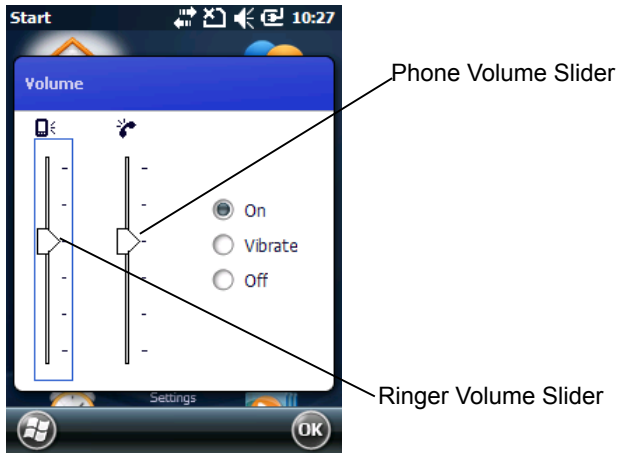

Figure 4-5 Phone Volume Slider

To adjust the volume tap the **Speaker** icon in the **Title** bar. Move the slider up or down to adjust the volume.



NOTE Adjust the conversation phone volume during a call. Adjusting the volume while not in a call affects the ring and notification sound levels.







Making a Call



- ✓ **NOTE** You can make emergency calls even when the MC45 is locked or when a SIM card is not installed. See [Making an Emergency Call on page 4-7](#) for more information.

With the MC45, you can make a call from the phone dialer, contacts, speed dial and call history.

Using the Phone Keypad

To make a call using the phone keypad:

1. Tap **Start** > **Phone** or press .
2. Enter the phone number on the dialer or keypad. The number appears in the Call Line.
3. Tap the green Call Line or press .
4. Tap  to cancel the call or tap  to place the MC45 in speakerphone mode.
5. When the call connects, the name or number appears in the Call Line. To place the call on hold, press . To return to the call, press  again.

- ✓ **NOTE** Placing a call on hold using the Call Line can be enabled. To enable, press  >  > **Enable Hold**. The toggle icon changes to **On**.

6. Tap  or press  to end the call.

Using Contacts

Use Contacts to make a call without looking up or entering the phone number.

To make a call from Contacts:

1. Tap **Start** > **Contacts**.
2. From the contact list, tap and hold the contact name.

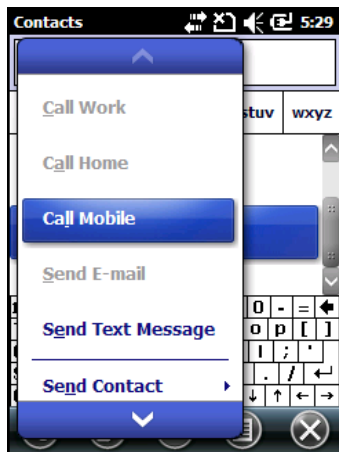



Figure 4-6 *Contacts Menu*

3. Tap **Call Work**, **Call Home** or **Call Mobile**.

✓ **NOTE** To make a call from an open contact, tap the number to call. See On-Device Help for more information about Contacts.

Using Call Log

To make a call using Call Log:

1. Tap **Start** > **Phone** or press .
2. From the Phone dialer, tap .

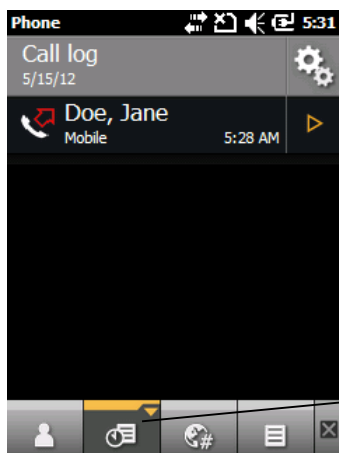

Call Log

Figure 4-7 *Call Log Window*

3. Tap on the desired Contacts name to begin dialing and return to the phone dialer.
4. Press  to stop dialing or end the call.

Making a Speed Dial Call

Use Speed Dial to call someone saved in the speed dial directory.

To make a speed dial call:

1. Tap **Start** > **Phone** or press .
2. From the Phone keypad, tap the speed dial location number assigned to a contact.

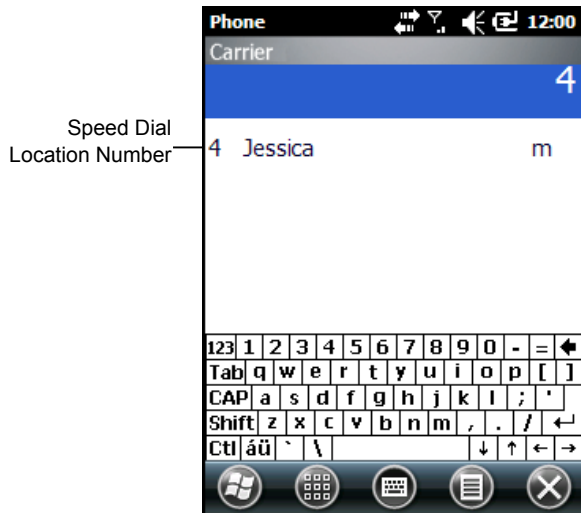

Figure 4-8 Speed Dial Contact List

3. Press  to stop dialing or end the call.

Making an Emergency Call

Your service provider programs one or more emergency phone numbers, such as 911, 999 or 112 that you can call under any circumstances, even when your phone is locked or the SIM card is not inserted. Your service provider can program additional emergency numbers into your SIM card. However, your SIM card must be inserted in your phone in order to use the numbers stored on it. See your service provider for additional information. See [Installing the mini-SIM Card on page 1-4](#) for SIM card installation procedures.

When the alpha-numeric keypad phone is locked, press the Orange key twice to set the keypad to numeric mode and then enter the emergency number.

- ✓ **NOTE** Emergency numbers vary by country. Your phone's pre-programmed emergency number(s) may not work in all locations, and sometimes an emergency call cannot be placed due to network, environmental, or interference issues.

Answering a Call

A dialog box appears on the MC45 when it receives an incoming call. If the phone is set to ring, a ring tone sounds. Answer or ignore the incoming call.

To answer an incoming call tap  on the **Phone - Incoming** dialog or press .

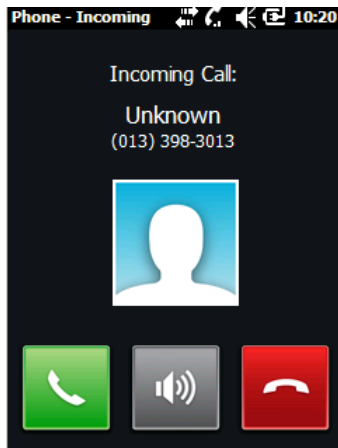









Figure 4-9 Incoming Call

To ignore the incoming call tap  or press . This may send the caller to voice mail, depending on the service provider. Otherwise, this presents busy signal to the calling party.

Press  to stop dialing or end the call.

Incoming Call Features

- You can use other programs on the MC45 during a call. To switch back to Phone, press  or tap **Start > Phone**. Tap **End** to end the call.
- If a caller isn't in your contact list, create a contact during the call or from Call History by tapping **Menu > Save to Contacts**.
- To hold the current call and answer a waiting call, tap  on the **Phone - Incoming** dialog or press  to place the current call on hold and answer the incoming call.
- To put a call on hold to call another number, press  or tap the green Call Line.
- To move from one call to another, press  on the MC45 or tap the green Call Line.

Smart Dialing

Smart Dialing makes it easy to dial a phone number. When you start entering numbers or characters, Smart Dialing automatically searches and sorts the contact entries on the SIM card, in Contacts, and the phone numbers in Call History (including incoming, outgoing, and missed calls). You can then select the desired number or contact from the filtered list to dial.

Open the Phone screen, then tap the keys on the Phone keypad that correspond to the phone number or contact to call. The contact panel lists contacts that match the sequence that you entered.

Smart Dialing starts looking for numbers or contacts that match the sequence entered.

To find a phone number:

- Enter the first one or two digits to find a phone number in Call History.

- Enter the first three digits or more to find a phone number from the saved Contacts and SIM card.

To find a contact name:

- Enter the first letter of a contact's first name or last name. Smart Dialing searches for the letter starting from the first character of a contact name as well as from the character that appears after a space, dash, or underscore in a contact name. For example, if you tap number "2" which is associated with [a, b, c] on the Phone keypad, contact names such as the following will be considered matches: "Smith, Bernard", "Adams, John", "Carlson, Eileen", "Dillon, Albert", "Childs, Larry", "Cooper, Robert" and "Parks, Celine".
- If the matching list is long narrow down the search further by entering another letter. Using the same example above, tap "3" which is associated with (d, e, f), the matching list is narrowed down to the following names: "Smith, Bernard", "Adams, John", and "Parks, Celine".

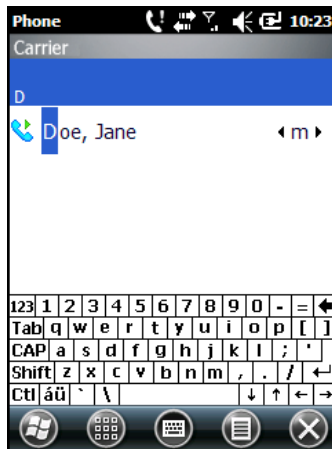



Figure 4-10 Finding a Contact

To make a call or send a text message using Smart Dialing:

1. Begin entering the first few numbers or characters.
2. In the Smart Dialing panel, use the up and down arrows on the keypad to navigate to the desired contact or phone number.
3. When the correct contact is selected, press  to make a voice call.
4. To send a text message to the selected contact, tap **Menu > Send Text Message**.
5. To call a different phone number associated with the selected contact, tap the contact name and select the phone number to call.

Muting a Call

During a call, you can mute the microphone so you can hear the person on the line but he or she cannot hear conversation from the microphone. This is useful when there is conversation or background noise on your end.

To mute or unmute a call:

1. Tap **Start > Phone** or press .
2. Make a call.



3. Tap  on the display to mute the audio. The **Mute** button becomes yellow.

Using Speed Dial

Create speed dial numbers to dial frequently called numbers with a single tap. Before creating a speed dial entry, ensure the phone number exists in Contacts.

Adding a Speed Dial Entry

To add a speed dial entry from the phone keypad:

1. Ensure the contact and phone number are in the Contacts list.
2. Tap **Start** > **Phone** or press .
3. Tap .

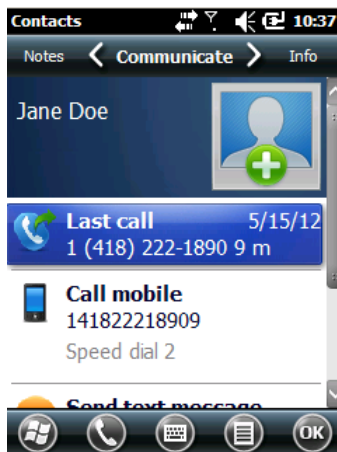



Figure 4-11 Contacts

4. Tap the desired contact name and number in the list.
5. Tap  > **Add to Speed Dial**.

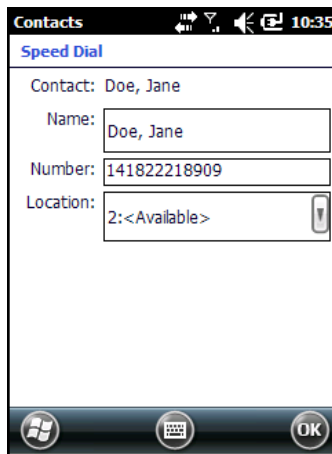

Figure 4-12 Speed Dial Contact Location

6. In the **Location** field, tap the up/down arrows to select an available location to assign as the new speed dial entry. The first speed dial location is reserved for voice mail.
7. Tap **OK** to add the contact to the speed dial list.

To add a speed dial entry from the **Contacts** window:

1. Tap **Start > Contacts**.



Figure 4-13 Contacts

2. Tap a contact name.
3. Tap **Menu > Add to Speed Dial**.

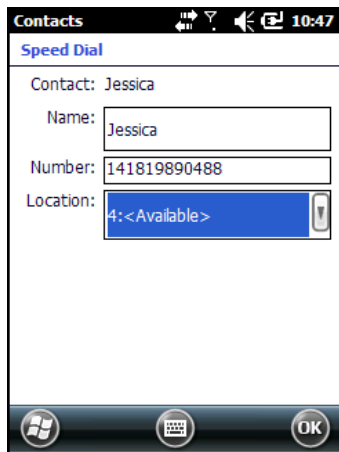





Figure 4-14 Speed Dial Contact Location

4. In the **Location** drop-down list, select a different available location to assign as the new speed dial entry. The first speed dial location is reserved for voice mail.
5. Tap **OK**.



Editing a Speed Dial Entry



To change a speed dial entry:

1. Tap **Start** > **Phone** or press .
2. Tap .
3. Tap the desired contact name in the list.
4. Tap  > **Edit Speed Dial**.
5. In the **Location** drop-down list, select a different available location to assign as the new speed dial entry. The first speed dial location is reserved for voice mail.
6. Tap **OK** to change the speed dial list.
7. Tap **OK** to exit the **Edit Contacts** window.
8. Tap **X** to exit the **Contacts** window.

Deleting a Speed Dial Entry

To delete a speed dial entry:

1. Tap **Start** > **Phone** or press .
2. Tap .
3. Tap the desired contact name in the list.

4. Tap  > **Edit Speed Dial**.
5. Tap .
6. Tap **Yes** to confirm permanently deleting the speed dial entry.

✓ **NOTE** Deleting names and phone numbers in **Speed Dial** does not delete the contact information in **Contacts (Start > Contacts)**.

7. Tap **OK** to exit the **Edit Contacts** window.
8. Tap **X** to exit the **Contacts** window.

Using Call Log

Use Call Log to call someone who was recently called, or recently called in. Call Log provides the time and duration of all incoming, outgoing, and missed calls. It also provides a summary of total calls and easy access to notes taken during a call. [Table 4-1](#) lists the call history icons that appear in the **Call Log** window.







Tap **Start > Phone** or press  and then tap  to open the **Call Log** window



Table 4-1 *Call Log Icons*

Icon	Description
	This icon appears next to the contact information for all outgoing calls.
	This icon appears next to the contact information for all incoming calls.
	This icon appears next to the contact information for all unconnected outgoing calls.
	This icon appears next to the contact information for all missed calls.

Managing Call Log

Change views, reset the call timer, and delete calls to manage the calls stored in Call Log.

Changing the Call Log View

1. Tap **Start > Phone** or press  and then tap  to open the **Call Log** window.
2. Tap  on the top right corner to show the **Call Log** menu.
3. Tap **Filters** and select a view type from the menu to display only received calls, outgoing calls, incomplete calls or missed calls.

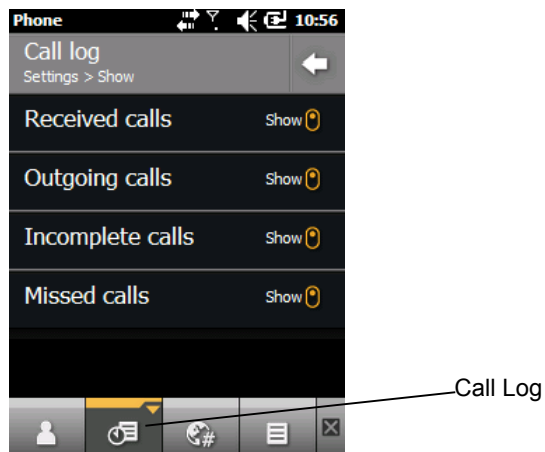





Figure 4-15 Call Log Window

4. Tap  to exit the **Call Log** window.

Deleting All Call Log Items

1. Tap **Start** > **Phone** or press  to display the Phone dialer.
2. From the Phone dialer, tap .
3. Tap  > **Delete call logs**.

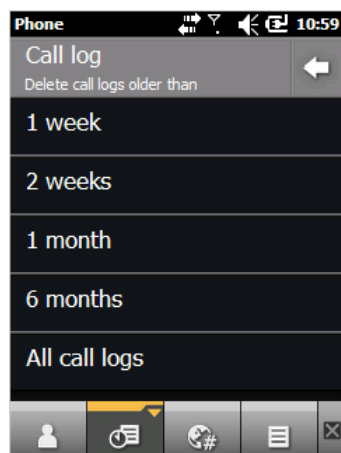

Figure 4-16 Call Log - Delete Call Logs Menu

4. Select **All call logs**.

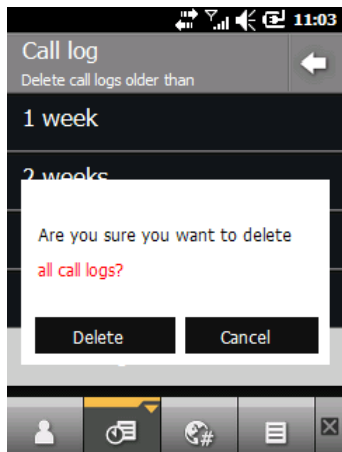





Figure 4-17 Call Log - Deleting all call logs

5. Tap **Delete**.
6. Tap **OK** to exit the **Call History** window.

Viewing Call Status

1. Tap **Start** > **Phone** or press  to display the Phone dialer.
2. From the Phone dialer, tap .
3. Tap an item to call the number or tap  to open the **Options** window for that item. The **Call Log Options** window appears.

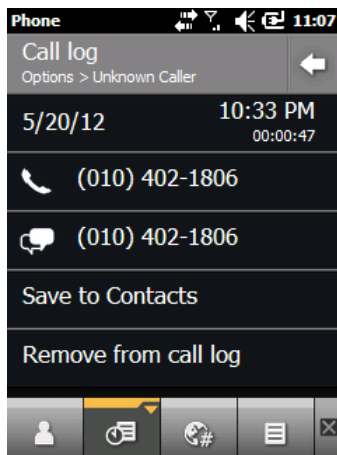







Figure 4-18 Viewing Call Status

4. Select an applicable option from the list.
5. Tap  to exit the **Options** window.
6. Tap  to close the **Call Log** window.

- ✓ **NOTE** When more than one call is on the phone line, only the duration of the first call is recorded.

Using the Call Log Options

Use the Call Log Options to dial voice mail, save to contacts, view a note, delete a listing, send a text message, and make a call.

1. Tap **Start** > **Phone** or press  to display the Phone dialer.
2. From the Phone dialer, tap .
3. Tap an item to call the number or tap  to open the **Options** window for that item. The **Call Log Options** window appears.

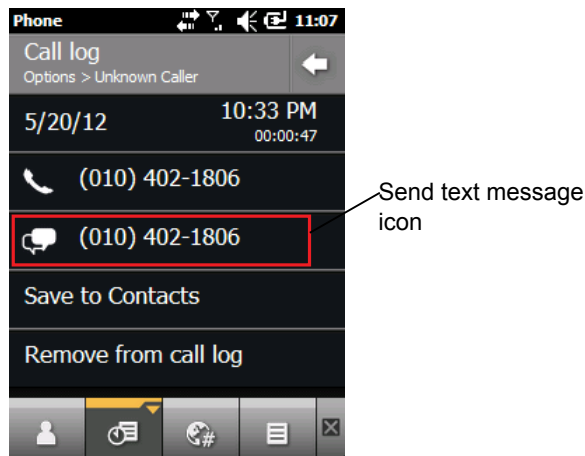







Figure 4-19 Call Log Option

4. Select an applicable item from the menu, as needed.
5. Depending on the item selected, the appropriate window displays. For example, select **Send Text Message** to display the **Inbox** window.
6. Tap  to exit the **Options** window.
7. Tap  to close the **Call Log** window.

Conference Calling on an MC45

- ✓ **NOTE** Conference Calling and the number of conference calls allowed may not be available on all services. Please check with your service provider for Conference Calling availability.

To create a conference phone session with multiple people:

1. Tap **Start** > **Phone** or press  to display the Phone dialer.
2. Enter the first phone number and tap the Call Line area or press . When the call connects, the name or number appears in the Call Line
3. Tap .
4. Tap . The dialer re-appears.
5. Enter the second number and tap **Send**.
6. When the call connects, the first call is placed on hold and the second call is active.

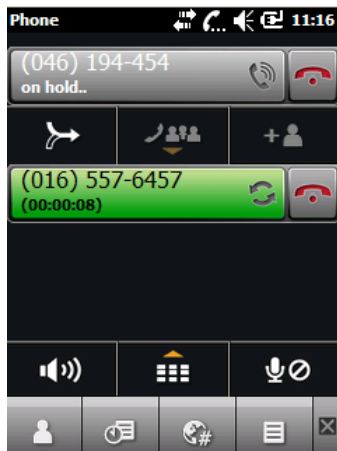



Figure 4-20 *Creating a Conference Call*

7. Tap call Line 1 to make that call active. The second call goes on hold.
8. Tap  to create a conference call (three callers).

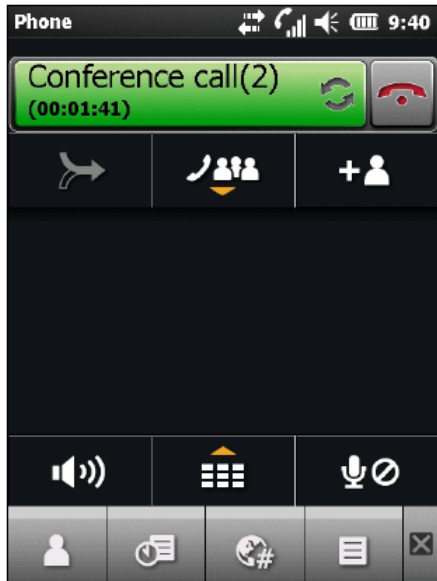



Figure 4-21 Two Merged Calls

9. To add a third caller, tap . The dialer appears. When the call connects, the new call is active and the conference is on hold.

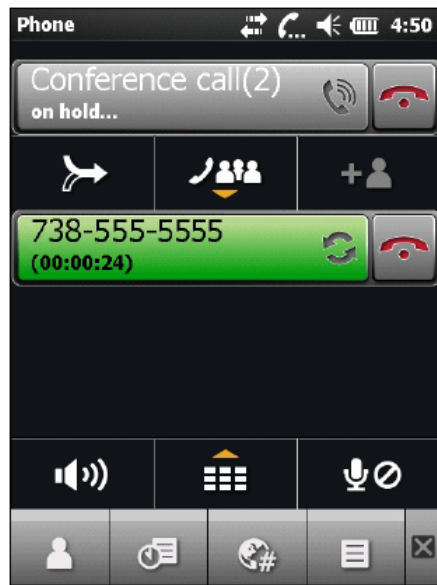



Figure 4-22 Adding a Third Call

10. To add the new caller to the conference, tap .

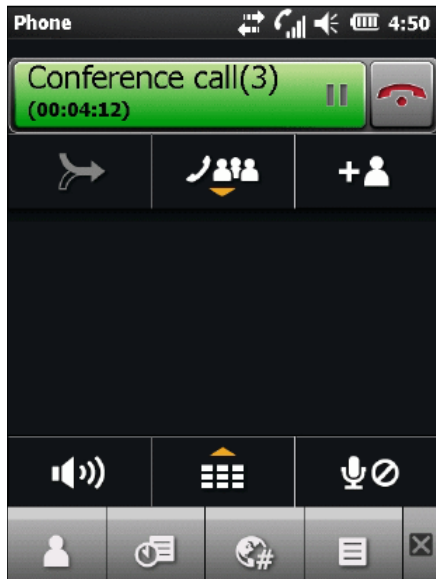



Figure 4-23 Three Merged Calls

11. Tap  to view all callers.

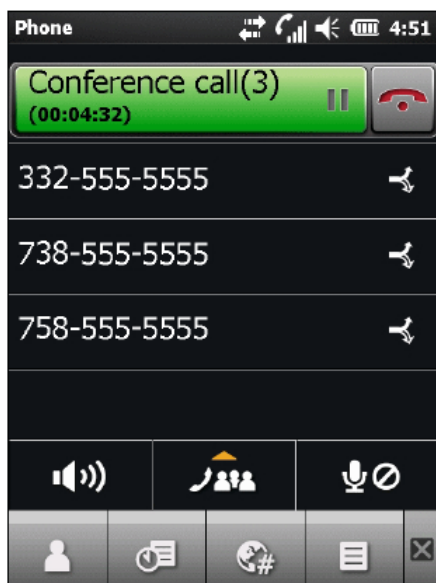









Figure 4-24 Un-Merge Calls

12. To remove a caller from the conference, tap the caller and then tap  next to the caller or press .
13. To end the conference call, tap  next to the Call Line or press .
- Call Completed** screen appears and then the dialer displays.

✓ **NOTE** To speak privately with one party during a conference call, tap  and then tap  next to the caller. To include all parties again, tap .

SMS Messaging

Text messages allow the user to send and receive short text messages (SMS) to and from other mobile devices. The text can contain words, numbers or an alphanumeric combination no longer than 160 characters.

Sending a Text Message

To send a text message:

1. Tap **Start > Text**.
2. Tap  > **New > SMS**.

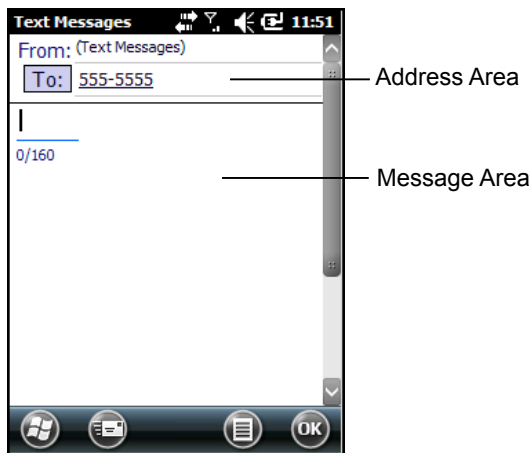



Figure 4-25 Create Text Message

3. Tap **To** to select a recipient from **Contacts**.
4. Compose your message.
 - The auto-correct feature automatically fixes common spelling errors as you type so your messages are more accurate.
 - The character counter lets you see and control the size of the message as you compose.
 - If you want to know if your text message was received, tap  > **Message Options**, then select the **Request message delivery notification** check box.
5. Tap  to send the message.

If the phone is turned on, your text message is sent. If it's off, you are prompted to turn on the phone. If you do so, the message is sent; otherwise when you tap **OK**, the message is saved in the **Drafts** folder and sent when the phone is turned on.

If you are out of coverage area, the message is saved in the **Drafts** folder and sent when you return to a coverage area.

✓ **NOTE** On MC45 devices, the message remains in the **Drafts** folder and has to be manually re-sent when you return to a coverage area.

Viewing Text Messages

To view a text message:

You can view a text message whether the phone is on or off. When the phone is on, you can view a text message from its notification callout. Tap the **text message notification** icon on the navigation bar to display the message.

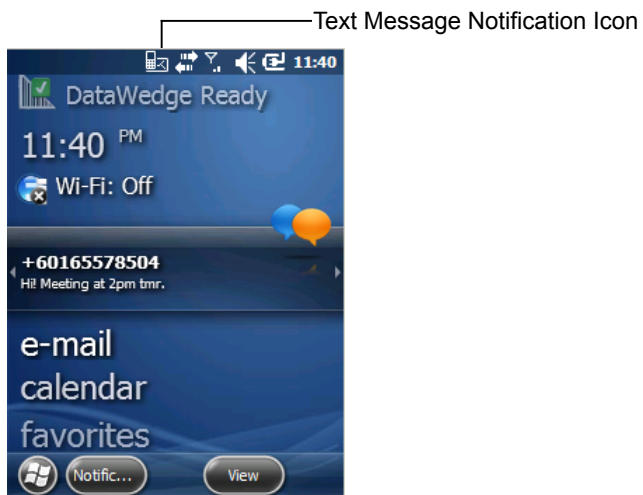

Figure 4-26 *New Text Message Notification*

The Caller Identification feature matches incoming text message numbers with those stored in **Contacts** so you know who is sending you a message. Furthermore, the **New Text Message** dialog box gives you the option to call the sender or save, dismiss, or delete the message.

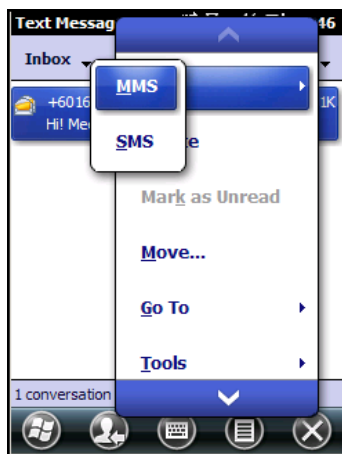

Figure 4-27 *New Text Message Options*

When the phone function is off, you can still view received text message in Messaging:

1. Tap **Start > Text** or on the Today screen, tap the text message on the Information Bar.

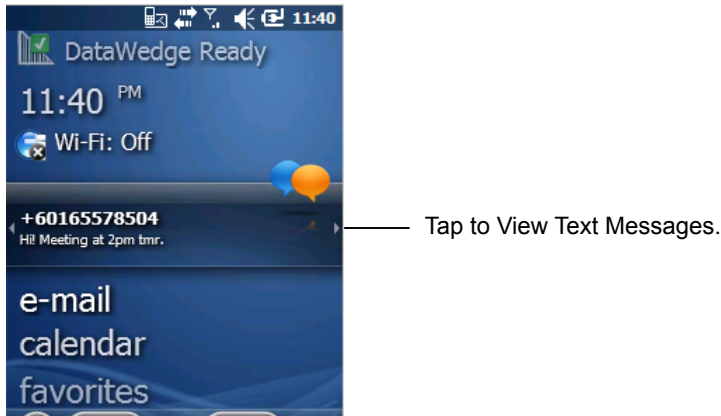

Figure 4-28 Text Messaging on Today Screen

2. The **Text Messages** window appears.
3. In the message list, tap the text message.

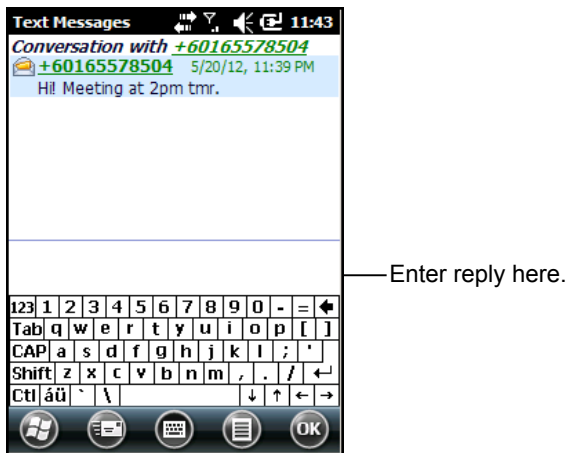



Figure 4-29 Text Messages List

Replying to a Text Message

To reply to a text message:

1. Tap **Start > Text**.
2. In the message list, tap a text message. The window displays previous text conversations.
3. Enter text in the reply field.
4. Tap  to send the reply.

MMS Messaging

MMS Messaging allows the user to send a pictures, videos, audio files and other file types to another mobile computer.

Creating and Sending MMS Messages

To send an MMS message:

1. Tap **Start > Text**.
2. Tap  > **New > MMS**.

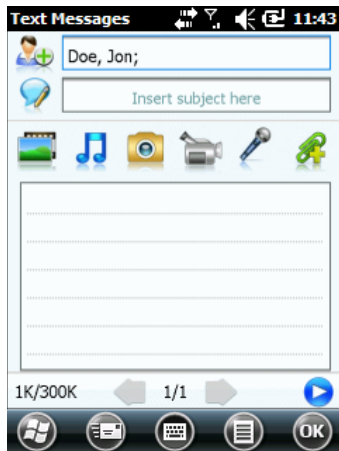









Figure 4-30 MMS Window

3. To add a contact, tap . A window appears with a list of contacts. Select one or more contacts and then tap **Done**.
4. Tap  to add a subject for the message. Enter the subject text in the window and then tap **Done**.
5. Tap in the text window to enter a text message. A window appears allowing you to add a text message plus emoticons, favorite web addresses, pre-defined text, contact information and calendar information. Tap **Done** after adding information.
6. Tap  to attach a picture or video stored on the MC45 to the message.
7. Tap  to attach a sound file stored on the MC45 to the message.
8. Tap  to take a picture and attach it to the message.
9. Tap  to capture video and attach it to the message.
10. Tap  to record a message and attach it to the message.
11. Tap  to add a file stored on the MC45 to the message.
12. After all of the items are attached to the message, tap **Send**.

Viewing an MMS Message

To view an MMS message:

1. Tap **Start > Text**.
2. Tap the MMS message.
3. In the threaded message, tap the MMS icon to view the message.

4. Tap **Contents** to view a list of files included in the message.

On the **Message Contents** screen:

1. Tap **Menu > Save** to save a file.
2. Tap **Menu > Save into My Text** to save the contents of a text file to the My Text list.
3. Tap **Menu > Assign to Contact** to associate a photo to a contact.
4. Tap **Menu > Set as Ringtone** to associate a audio file as a ringtone.

Replying to an MMS Message

To reply to an MMS message

1. Tap **Start > Text**.
2. Tap the MMS message.
3. In the threaded message, tap the MMS message to open and view an MMS message.
4. After viewing the MMS message, tap **Menu > Reply > via MMS** to reply with an MMS message or tap **Menu > Reply > via SMS** to reply with a text message.

Blocking Incoming MMS Messages

To block incoming MMS messages from a specific sender:

1. Open and view the MMS message.
2. Tap **Menu > Show > Contact Details**.
3. Tap **Menu > Save to Blacklist**.
4. Tap **Done**.

To unblock a sender:

1. Tap **Start > Text**.
2. Tap **Menu > MMS Options > Blacklist**.
3. Tap and hold the phone number.
4. Select **Delete** from the pop up menu.
5. Tap **OK**.

Voice Commander

Voice Commander is a speech dialog system that provides natural human interface for users to communicate seamlessly with the MC45. Users can make phone calls, look up contact information, launch programs or check calendars. Voice Commander contains the following features:

- Eyes-free and hands-free voice command and control.
- Speaker-independent speech recognition technology, no training is required.

- Ease of use conversational user interface.
- Personal Voice Tag and Digit Model Adaptation to enhance the usability.

To initiate Voice Commander tap **Start > Toolbox > Voice Commander** or press the call button on a Bluetooth headset. The system says, “*Say a Command.*” The user says one of the following commands:

- Call
- Find
- Redial / Callback
- Play Music
- Play
- Next / Previous
- Start
- Appointments
- Read / Call History
- What time is it?
- What can I say?
- Goodbye

Call

To call a person by name:

1. Initiate **Voice Commander**. The MC45 responds with “*Say command.*”
2. Say “*Call Michael Archer.*” System responds with “*Call Michael Archer work, is it correct?*”
3. Say “*Yes.*” MC45 responds with “*Dialing.*”

To call a person at a location:

1. Initiate **Voice Commander**. The MC45 responds with “*Say command.*”
2. Say “*Call Mary Smith at home.*” The MC45 responds with “*Call Mary Smith home, is it correct?*”
3. Say “*Yes.*” The MC45 responds with “*Dialing.*”

To call a person with more than one phone number:

1. Initiate **Voice Commander**. The MC45 responds with “*Say command.*”
2. Say “*Call Alex Jordan.*” The MC45 responds with “*Call Alex Jordan, home, work, mobile or cancel?*”
3. Say “*Home.*” The MC45 responds with “*Dialing.*”

If two people have similar names:

1. Initiate **Voice Commander**. The MC45 responds with “*Say command.*”
2. Say “*Call Halley Johnson.*” The MC45 responds with “*More than one Halley Johnson, please select.*”
3. Select the contact intended to call.



NOTE Voice Commander automatically maintains a maximum of 2000 contacts in the recognition database.

If the command can not be recognized, **Voice Commander** prompts *“Please say again.”* This situation could happen under the noisy environment, or when user says command before Voice Commander starts recording. After hearing the prompt *“Say Command”*, user should wait one to two seconds to speak the command.

The recognizable contact length is 48 characters. Contacts exceeding 48 characters will be ignored.

Find

To look up contact information:

1. Initiate **Voice Commander**. The MC45 responds with *“Say command.”*
2. Say *“Find Mary Smith.”* The MC45 responds with *“Mary Smith home 5555551212.”*

To look up a specific number:

1. Initiate **Voice Commander**. The MC45 responds with *“Say command.”*
2. Say *“Find Michael Archer at work.”* The MC45 responds with *“Michael Archer, work, 5555551212.”*

If two contacts have similar names:

1. Initiate **Voice Commander**. The MC45 responds with *“Say command.”*
2. Say *“Find Haley Johnson at work.”* The MC45 responds with *“More than one Haley Johnson, please select.”* Voice Commander displays a window with the two contacts. (System will show both Halley Johnson and Haley Johnson for user to select.)

If a contact is not found:

1. Initiate **Voice Commander**. The MC45 responds with *“Say command.”*
2. Say *“Find Michael Archer at home.”*
3. MC45 responds with *“Michael Archer has no home number.”*

Redial

To redial a previous number:

1. Initiate **Voice Commander**. The MC45 responds with *“Say command.”*
2. Say *“Redial.”* The MC45 responds with *“Call Mary Smith at home, is it correct?”*
3. Say *“Yes.”* The MC45 responds with *“Dialing.”*

Callback

1. Initiate **Voice Commander**. The MC45 responds with *“Say command.”*
2. Say *“Callback.”* The MC45 responds with *“Call Mary Smith at home, is it correct?”*
3. Say *“Yes.”* The MC45 responds with *“Dialing.”*

Start

To launch an application:

1. Initiate **Voice Commander**. The MC45 responds with “*Say command.*”
2. Say “*Start calendar.*” The MC45 responds with “*Go to Calendar.*” The Calendar application launches.

Appointments

To read today’s, tomorrow’s or this week’s appointments:

1. Initiate **Voice Commander**. The MC45 responds with “*Say command.*”
2. Say “*Today’s appointment.*” The MC45 responds with “*You have 3 appointments*” and reads the appointments.



NOTE User can say Previous, Next, Repeat, or Abort to control calendar reading. Voice Commander only plays the new appointments. Older appointments are ignored.

Read

To read a text message or an email message:

1. Initiate **Voice Commander**. The MC45 responds with “*Say command.*”
2. Say “*Read SMS.*” The MC45 responds with “*You have 3 SMS*” and reads the SMS messages.

What time is it

To find out the time of day:

1. Initiate **Voice Commander**. The MC45 responds with “*Say command.*”
2. Say “*What time is it?*” The MC45 responds with “*The time is 3 p.m.*”

Call History

To view the call history window:

1. Initiate **Voice Commander**. The MC45 responds with “*Say command.*”
2. Say “*Call History.*” The MC45 responds with “*Call history.*”
3. The **Call History** page displays.

Voice Play Music

To play a specific music file:

1. Initiate **Voice Commander**. The MC45 responds with “*Say command.*”
2. Say “*Play The Moment.*” The MC45 responds with “*The Moment.*”
3. Windows Media starts to play “*The Moment.*”

To play all music files:

1. Initiate **Voice Commander**. The MC45 responds with “*Say command.*”
2. Say “*Play music.*” The MC45 responds with “*Play music.*”
3. Windows Media starts to play all music files.

To play a different music file during playing of another:

1. Initiate **Voice Commander**. The MC45 responds with “*Say command.*”
2. Say “*Next.*” The MC45 responds with “*Next.*”
3. Windows Media starts to play next music file.

To pause or resume a playing music file:

1. Initiate **Voice Commander**. The MC45 responds with “*Say command.*”
2. Say “*Pause*” or “*Resume.*” The MC45 pauses or resumes the playing music.

✓ **NOTE** User can say “Pause” or “Resume” to control music playing. The command “Resume” only works when Windows Media is running. The commands “Previous” and “Next” only work when playing all music files.

Voice Commander only supports media files with .mp3 and .wma format. Voice Commander supports the music files in Playlists or Media files synched by Active Sync, in My Documents and its subfolder or on the microSD card and its subfolders.

What can I say

To view the help information:

1. Initiate **Voice Commander**. The MC45 responds with “*Say command.*”
2. Say “*What can I say.*” The help file displays.

Alternatively tap **Menu > Help** to open the help file.

Goodbye

To exit the **Voice Commander** application, Say “*Goodbye.*” The MC45 responds with “*Goodbye*” and the application terminates.

Voice Commander can be also terminated manually by tapping **Menu > Exit**. Note that goodbye will not be accepted during voice digit dialing operation.

✓ **NOTE** **Voice Commander** automatically terminates after 10 seconds of silence.

CHAPTER 5 USING WLAN

Introduction



NOTE The WLAN feature is only applicable for the MC4597.

The WLAN feature supports the 802.11 a/b/g networking mode.

WLANs allow the MC45 to communicate wirelessly inside a building. Before using the MC45 on a WLAN, the facility must be set up with the required hardware to run the WLAN (sometimes known as infrastructure). The infrastructure and the MC45 must both be properly configured to enable this communication.

Refer to the documentation provided with the infrastructure (access points (APs), access ports, switches, Radius servers, etc.) for instructions on how to set up the infrastructure.

Once you have set up the infrastructure to enforce your chosen WLAN security scheme, use the Fusion or Wireless Zero Config (WZC) software to configure the MC45 to match.

Fusion Overview

The Fusion software contains applications with which to create wireless profiles. Each profile specifies the security parameters to use for connecting to a particular WLAN as identified by its ESSID. The Fusion software also allows the user to control which profile out of a set of profiles is used to connect. Other Fusion applications allow the user to monitor the status of the current WLAN connection and to invoke diagnostic tools for troubleshooting.

To access Fusion, tap the **Start** >  > **Wireless Launcher**.

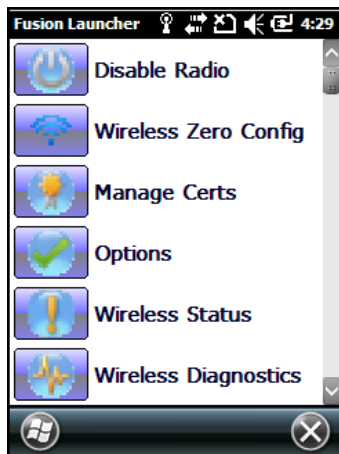



Figure 5-1 Fusion Launcher Window

Refer to the *Wireless Fusion Enterprise Mobility Suite User Guide for Version 3.xx* for detailed information on using and configuring Fusion.

To access the on-device Fusion Help tap **Start** >  > **Fusion Help**.

Connecting to the Internet

To connect to the Internet on a WLAN when using Fusion, ensure that the network card settings is set to Internet:

1. Ensure Fusion is enabled and a profile is configured.
2. Tap **Start** > **Settings** > **Connections** > **WLAN**.
3. In the **My network card Connects to** drop-down list, select **The Internet**.
4. Tap **OK**.

Wireless Zero Config Overview

WZC is a Microsoft wireless connection management utility that dynamically selects a wireless network to connect to based on a user's preferences and various default settings.

Switching Between Fusion and WZC

To switch from Fusion to WZC:

1. Tap the **Start** >  > **Wireless Launcher** > **Options**.
2. Select **WLAN Management** from the drop-down list.
3. Select **Microsoft Manages WLAN** radio button.
4. Tap **Save**.
5. Tap **OK**.
6. Perform a reset.

To switch from WZC to Fusion:

1. Tap the **Start** >  > **Wireless Launcher** > **Options**.
2. Select **WLAN Management** from the drop-down list.
3. Select **Fusion Manages WLAN** radio button.
4. Tap **Save**.
5. Tap **OK**.
6. Perform a reset.

Supported Applications

The Fusion menu items and their corresponding applications are summarized in [Table 5-1](#).

Table 5-1 *Supported Applications*

Application	Description	Fusion Support	WZC Support
Find WLANs	Invokes the Find WLANs application which displays a list of the WLANs active in your area.	Yes	No
Manage Profiles	Invokes the Manage Profiles application (which includes the Profile Editor Wizard) to manage and edit your list of WLAN profiles.	Yes	No
Wireless Zero Config	Invokes the Wireless Zero Config application to configure the WLAN.	No	Yes
Manage Certs	Invokes the Certificate Manager application which allows you to manage certificates used for authentication.	Yes	Yes
Manage PACs	Invokes the PAC Manager application which helps you manage the list of Protected Access Credentials used with EAP-FAST authentication.	Yes	No
Options	Invokes the Options application which allows you to configure the Fusion option settings.	Yes	Yes
Wireless Status	Invokes the Wireless Status application which allows you to view the status of the current wireless connection.	Yes	Yes
Wireless Diagnostics	Invokes the Wireless Diagnostics application which provides tools with which to diagnose problems with the wireless connection.	Yes	Yes
Log On/Off	Invokes the Network Login dialog which allows you to log on to a particular profile or to log off from the currently active profile	Yes	No
Fusion Help	Invokes the Fusion Help application which provides detailed explanations on all the available Fusion applications	Yes	No

Fusion Setup

To setup WLAN using Fusion refer to the *Wireless Fusion Enterprise Mobility Suite User Guide for Version H3.40* for detailed information on using and configuring Fusion.

To setup WLAN using Fusion:

- ✓ **NOTE** Obtain the proper WLAN configuration information from your system administrator prior to performing the Fusion setup procedures.

The following setup procedure example shows setup of a WLAN using WEP encryption.

1. Tap the **Start** >  > **Wireless Configuration Editor** > **Manage Profiles**. The **Manage Profiles** window appears.
2. Tap and hold in the window and select **Add** from the pop-up menu. The **Wireless LAN Profile Entry** window appears.
3. In the **Profile Name** text box enter a name for the profile.
4. In the **ESSID** text box enter the ESSID.

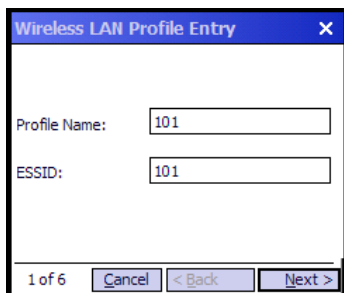

Figure 5-2 Profile ID Dialog Box

5. Tap **Next**. The **Operating Mode** dialog box displays.
6. In the **Operating Mode** drop-down list, select **Infrastructure** or **Ad-hoc**.

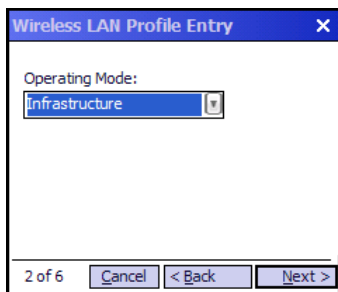

Figure 5-3 Operating Mode Dialog Box

7. Tap **Next**. The **Security Mode** dialog box displays.
8. In the **Security Mode** drop-down list, select **Legacy (Pre-WPA)**.

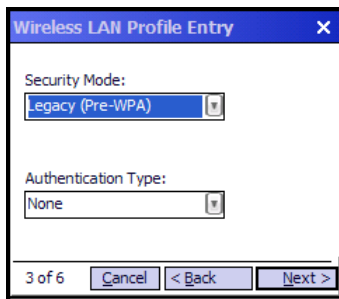

Figure 5-4 Security/Authentication Dialog Box

9. In the **Authentication** drop-down list, select **None**.
10. Tap **Next**. The **Encryption** dialog box displays.
11. In the **Encryption Type** drop-down list, select **WEP-40 (40/24)**.

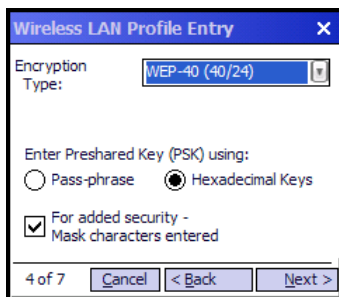

Figure 5-5 Encryption Dialog Box

12. Select the **Pass-phrase** or **Hexadecimal Keys** radio button to indicate whether a pass-phrase or hexadecimal keys will be entered on the next page.
13. Select the **For added security - Mask characters entered** check box to hide characters entered. Deselect this to show characters entered.
14. Tap **Next**.

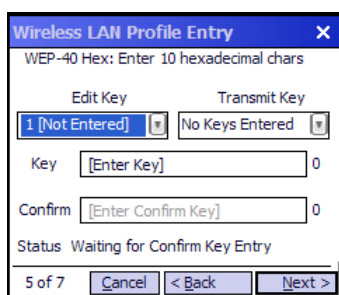

Figure 5-6 WEP-40 WEP Keys Dialog Box

15. In the **Edit Key** drop-down list, select the key to enter.
16. In the **Key** field, enter 10 hexadecimal characters.
17. In the **Confirm** field, re-enter the key. When the keys match, a message appears indicating that the keys match.
18. Repeat for each WEP key.

19. In the **Transmit Key** drop-down list, select the key to transmit.
20. Tap **Next**. The **IPv4 Address Entry** dialog box displays.

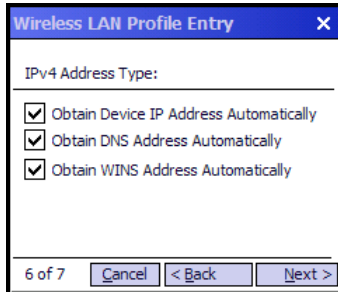

Figure 5-7 IP Address Entry Dialog Box

21. Ensure that all three check boxes are selected.
22. Tap **Next**. The **Battery Usage** dialog box appears.
23. In the **Battery Usage Mode** dialog box select a power consumption option.

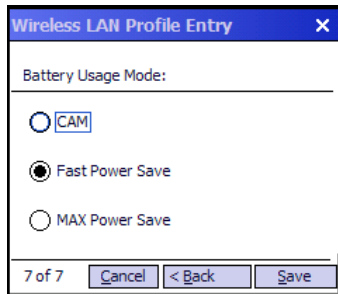

Figure 5-8 Battery Usage Dialog Box

24. Tap **Save**.

Wireless Zero Config Setup

To setup WLAN using WZC:

- ✓ **NOTE** Obtain the proper WLAN configuration information from your system administrator prior to performing the WZC setup procedures.

The following setup procedure example shows setup of a WLAN using WEP encryption.

1. Tap **Start** >  > **Wireless Launcher** > **Wireless Zero Config**.



Figure 5-9 *Wireless Zero Config Window*

2. The MC45 searches for wireless networks in the area and displays them in the window.
3. Tap a network name.

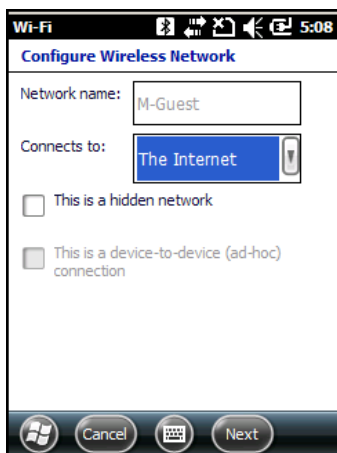

Figure 5-10 *Configure Wireless Network Window*

4. In the **Connects to** drop-own list, select either **The Internet** or **Work**.
5. Check the **This is a hidden network** checkbox if the network is a hidden network.
6. Tap **Next**.

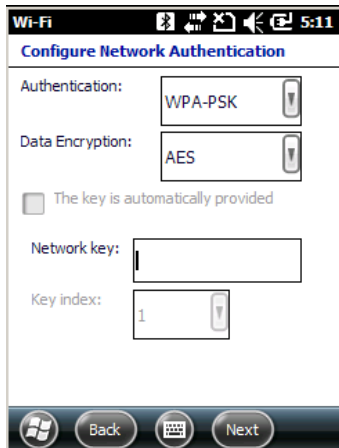

Figure 5-11 *Configure Network Authentication Window*

7. In the **Authentication** drop-down list, select the authentication type.
8. In the **Data Encryption** drop-down list, select the data encryption type.
9. If **WEP encryption** is selected, enter an encryption key in the **Network key** text box.
10. Tap **Next**.

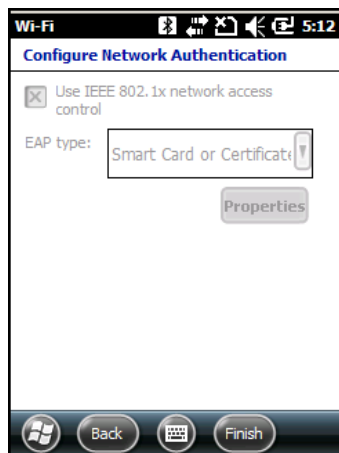

Figure 5-12 *Configure Network Authentication Window*

11. If required, select **Use IEEE 802.1x network access control** check box.
12. In the **EAP type** drop-down list box, select the EAP type.
13. Tap **Finish**.

More Information on WZC

For more information on Microsoft Wireless Zero Config, see the Microsoft Software Developer Network (MSDN) at <http://msdn.microsoft.com>.

Chapter 6 Using GPS Navigation

Introduction

The MC45 includes Global Positioning System (GPS) technology using the QC Modem Solution chipset. GPS technology is based on a worldwide system of GPS satellites orbiting the earth that continuously transmit digital radio signals. These radio signals contain data on the satellites' locations and their exact clock time and are used to determine your location on the earth.



WARNING! When using the MC45 in a vehicle, it is the user's responsibility to place, secure and use in a manner that will not cause accidents, personal injury or property damage or obstruct their view. It is the responsibility of the driver to operate the vehicle in a safe manner, maintain observation of all driving conditions at all times, and not become distracted by the device to the exclusion of safe driving practices. It is unsafe to operate the controls of the device while driving.

Software Installation

Third-party GPS navigation software is required. Evaluation software is available from various suppliers. For example; VisualGPS, visit: <http://www.visualgps.net/VisualGPSce/>

If interested in purchasing GPS navigation software check with the GPS software vendor (before purchasing, downloading, or installing any software) to determine that the application is compatible with the MC45. Refer to the application's user guide for application installation and setup information.

MC45 GPS Setup

By default, the MC45 has the following settings:

1. Tap **Start > Settings > System > External GPS** icon.
2. In the **Programs** tab, the **GPS program port** is set to **COM6**.
3. In the **Hardware** tab, the **GPS hardware port** is set to **None**.

Multiple programs can simultaneously access GPS data. Each program must use Microsoft GPS API or COM8 to access the GPS data.

Operation

Acquiring satellite signals may take several seconds to a few minutes. It is best to be outside and have a clear, unobstructed view of the sky. Without a clear view, acquisition takes much longer and could result in the MC45 being unable to compute the initial position quickly. When operating the device indoors access to the GPS signals may be limited or unavailable.

- ✓ **NOTE** When using a GPS navigation application, ensure that the MC45 does not go into suspend mode. If the MC45 suspends then the power to the GPS radio is removed. Upon resume the GPS receiver must reacquire a valid GPS signal, resulting in a a delay of positional information.

GPS Maps on microSD Cards

GPS navigation software vendors may sell maps on microSD cards. If using a microSD card with the GPS navigation software:

1. Slide the mini-SIM card holder to the right to unlock.
2. Lift the mini-SIM card holder.
3. Slide the microSD card holder down to unlock.
4. Lift up the microSD card holder.
5. Insert the card with the card contacts facing down and lower the microSD card holder.
6. Slide the microSD card holder up to lock.
7. Lower the mini-SIM card holder.
8. Slide the mini-SIM card holder to the left to lock.

Answering a Phone Call While Using GPS

If you receive a phone call while using your GPS navigation software:

1. Answer the phone call by pressing the **Answer** button.
2. Once you end the phone call, press the **End Call** button to resume the audio on the GPS software.

- ✓ **NOTE** Anytime you are using GPS on the MC45 and you receive a phone call, the audio on the GPS navigation software is muted until you finish the call.

Losing the GPS Signal While in a Vehicle

GPS performance on the MC45 may be affected if the vehicle has thermal glass windows and windshields, which can block the MC45 from receiving a GPS signal from satellites. To improve GPS signal strength, place the MC45 where there is a clear view of the sky. A direct line of sight is required between the MC45 and the GPS satellites to access information from the satellites.

Assisted GPS

GPS can be used in stand-alone or Assisted GPS (A-GPS) modes. A Stand-alone GPS receiver downloads data from GPS satellites. It can take several minutes to get a fix. By using GPS Location servers, A-GPS dramatically improves the performance of the Time To First Fix (TTFF) of GPS receivers by providing them with data that they would ordinarily have to download from the GPS satellites and other aiding data that helps the acquisition. With the A-GPS data, GPS receivers can operate faster and more reliably.

The **GPS Assist** application provides the ability to modify the settings associated with obtaining GPS data.

Tap **Start > Connections > GPS Assist** icon.

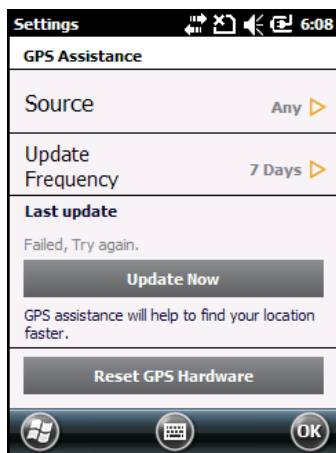

Figure 6-1 GPS Assistance Window

To set the source of the data tap **Source** and select one of the options: **Any** (default), **None**.

To set the frequency of updating the data tap **Update Frequency** and select one of the options: **On Demand** (default), **1 Day**, **2 Days**, **4 Days**, **7 Days**.

To manually update the data tap the **Update Now** button.

GPS Reset

To perform a factory reset of the GPS function:

1. Close all applications that are using GPS.
2. Tap the **Reset GPS Hardware** button. The **Reset GPS Hardware** dialog box appears indicating that the GPS chip has been reset.
3. Tap **OK**.

Chapter 7 Using Bluetooth

Introduction

Bluetooth-equipped devices can communicate without wires, using frequency-hopping spread spectrum (FHSS) radio frequency (RF) to transmit and receive data in the 2.4 GHz Industry Scientific and Medical (ISM) band (802.15.4). Bluetooth wireless technology is specifically designed for short-range (30 feet/10 meters) communication and low power consumption.

MC45 with Bluetooth capabilities can exchange information (e.g., files, appointments, and tasks) with other Bluetooth enabled devices such as phones, printers, access points, and other mobile computers. To use the MC45 as a modem, create a dial-up modem connection between a computer and MC45.

The MC45 with Bluetooth technology uses the Microsoft Bluetooth stack. To write an application that uses the Microsoft Bluetooth stack APIs, refer to the Enterprise Mobility Developer Kit (EMDK) Help.

Adaptive Frequency Hopping

Adaptive Frequency Hopping (AFH) is a method of avoiding fixed frequency interferers, and can be used with Bluetooth voice. All devices in the piconet (Bluetooth network) must be AFH-capable in order for AFH to work. There is no AFH when connecting and discovering devices. Avoid making Bluetooth connections and discoveries during critical 802.11b communications. AFH for Bluetooth consists of four main sections:

- Channel Classification - A method of detecting an interference on a channel-by-channel basis, or pre-defined channel mask.
- Link Management - Coordinates and distributes the AFH information to the rest of the Bluetooth network.
- Hop Sequence Modification - Avoids interference by selectively reducing the number of hopping channels.
- Channel Maintenance - A method for periodically re-evaluating the channels.

When AFH is enabled, the Bluetooth radio “hops around” (instead of through) the 802.11b high-rate channels. AFH coexistence allows Zebra mobile computers to operate in any infrastructure.

The Bluetooth radio in this MC45 operates as a Class 2 device power class. The maximum output power is 2.5mW and the expected range is 32.8 feet (10 meters). A definition of ranges based on power class is difficult to obtain due to power and device differences, and whether one measures open space or closed office space.

✓ **NOTE** It is not recommended to perform Bluetooth wireless technology inquiry when high rate 802.11b operation is required.

Security

The current Bluetooth specification defines security at the link level. Application-level security is not specified. This allows application developers to define security mechanisms tailored to their specific need. Link-level security occurs between devices, not users, while application-level security can be implemented on a per-user basis. The Bluetooth specification defines security algorithms and procedures needed to authenticate devices, and if needed, encrypt the data flowing on the link between the devices. Device authentication is a mandatory feature of Bluetooth while link encryption is optional.

Pairing of Bluetooth devices is accomplished by creating an initialization key that is used to authenticate the devices and create a link key for them. Entering a common PIN number in the devices being paired generates the initialization key. The PIN number is never sent over the air. By default, the Bluetooth stack responds with no key when a key is requested (it is up to user to respond to the key request event). Authentication of Bluetooth devices is based-upon a challenge-response transaction. Bluetooth allows for a PIN number or passkey that is used to create other 128-bit keys used for security and encryption. The encryption key is derived from the link key used to authenticate the pairing devices. Also worthy of note is the limited range and fast frequency hopping of the Bluetooth radios that makes long-distance eavesdropping difficult.

Recommendations are:

- Perform pairing in a secure environment
- Keep PIN codes private and don't store the PIN codes in the mobile computer
- Implement application-level security.

The Microsoft stack supports Smart-pairing. For detailed information, refer to the Microsoft MSDN.

Bluetooth Configuration

The following services are supported

- A2DP/AVRCP Services
- Dial-Up Networking Services
- File Transfer profile
- General Audio/Video Distribution Profile
- Generic Access Profile
- Generic Object Exchange Profile
- Hands-Free Audio Gateway Services
- Headset Profile
- HID Client Services
- PBAP Services
- Personal Area Networking Services
- Serial Port Services
- Service Discovery Access profile
- SIM Access Profile.

COM2 through COM4 and COM8 are available unless being used by another service.

Bluetooth Power States

Suspend

When there is an active Bluetooth connection, the Bluetooth radio goes into low power mode maintaining the active connection. When there is no active connection, the Bluetooth radio turns off.



NOTE If there is an active Bluetooth connection between the MC45 and another Bluetooth device and there is no data activity, the MC45 will timeout. However, if the user presses the Power button on the MC45, the MC45 will suspend (except when on a call) and upon receiving data from a remote Bluetooth device, the MC45 will wake from suspend mode. For example, headset redial or Bluetooth scanner sending data to the MC45.

Resume

When the MC45 resumes, Bluetooth turns on if it was on prior to suspend.

Turning Bluetooth On and Off

Turn off the Bluetooth radio to save power or if entering an area with radio restrictions (e.g., an airplane). When the radio is off, other Bluetooth devices cannot see or connect to the MC45. Turn on the Bluetooth radio to exchange information with other Bluetooth devices (within range). Communicate only with Bluetooth radios in close proximity.

✓ **NOTE** To achieve the best battery life turn off radios not in use.

Enabling Bluetooth

To enable Bluetooth:

1. Tap **Wireless Manager** and then tap the **Bluetooth** bar or
Tap **Start > Settings > Connections > Wireless Manager > Bluetooth** bar.



Figure 7-1 *Wireless Manager Window*

2. Tap on the **Bluetooth** bar to turn on Bluetooth.

Disabling Bluetooth

To disable Bluetooth:

1. Tap **Wireless Manager** and then tap the **Bluetooth** bar or
Tap **Start > Settings > Connections > Wireless Manager > Bluetooth** bar.
2. Tap on the **Bluetooth** bar to turn off Bluetooth.

Discovering Bluetooth Device(s)

The MC45 can receive information from discovered devices without bonding. However, once bonded, the MC45 and a bonded device exchange information automatically when you turn the Bluetooth radio on. To find Bluetooth devices in the area:

1. Ensure that Bluetooth is enabled on both devices.
2. Ensure that the Bluetooth device to discover is in discoverable and connectable modes.
3. Ensure that the two devices are within 30 feet (10 meters) of one another.
4. Tap **Start > Settings > Connections > Wireless Manager > Menu > Bluetooth Settings > Devices**.



Figure 7-2 Bluetooth - Devices Tab

5. Tap **Add new device**. The MC45 begins searching for discoverable Bluetooth devices in the area.

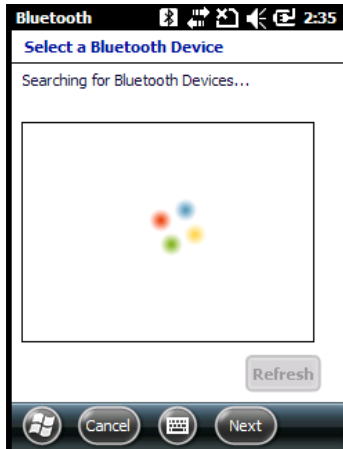

Figure 7-3 Searching for Bluetooth Devices

6. Select a device from the list.

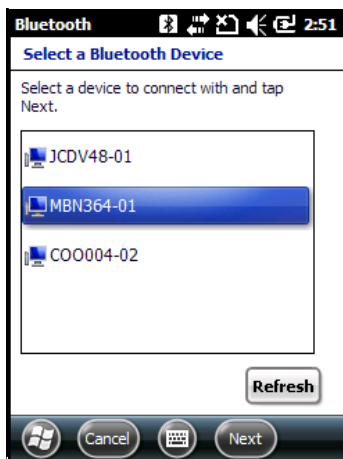

Figure 7-4 Select a Bluetooth Device

7. Tap **Next**. The **Enter Passcode** window appears.



NOTE If Smart-pairing is configured and the device is requesting one of the pre-defined PINs, the **Enter Passcode** window does not appear.

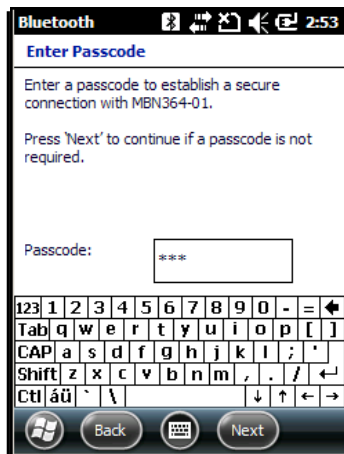

Figure 7-5 Enter Passcode

8. Enter the Passcode on the other device. The device is added to the Bluetooth list.

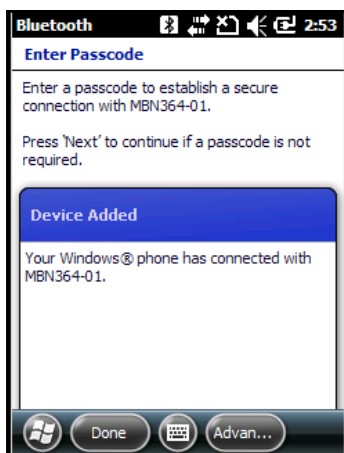

Figure 7-6 Bluetooth Connection Confirmation

You are prompted to enter a passcode. If the device has a specific passcode, enter it in the Passcode field and tap **Next**. If the device does not have a specific passcode, enter a passcode in the Passcode field and tap **Next**. The Bluetooth radio tries to connect with the device.

9. If you created a passcode, you will be prompted by the other device to enter the same passcode. Enter the created passcode to establish a paired connection. (If you entered a passcode from the device, you shouldn't have to do anything on the other device.)
10. When the connection is complete, a list of matching and supported services on the device appears.
11. Select the services you want to use and tap Finish. The services on the new devices have to be selected or else the pairing won't include those services, even though the devices are paired. If services are not selected, you will be continually reprompted for the passcode from the device.
12. The device appears in the list on the main window.

After the passcodes have been accepted on both sides, you have a trusted ("paired") connection.

Available Services

- ✓ **NOTE** Some devices might not require a PIN. This depends upon the device's authentication.

See the following sections for information on available services.

Object Push Services via Beam

- ✓ **NOTE** You can only send files to a remote device using the Beam function.

Use the OBEX Push Service to send files and contacts to another Bluetooth device. To transfer files between the MC45 and another Bluetooth enabled device:

1. Ensure that Bluetooth is enabled and discoverable on both devices.
2. Ensure that the two devices are within 30 feet (10 meters) of one another.
3. Tap **Start > File Explorer**.
4. Navigate to the file to transfer.
5. Tap and hold on the filename until the pop-up menu appears.

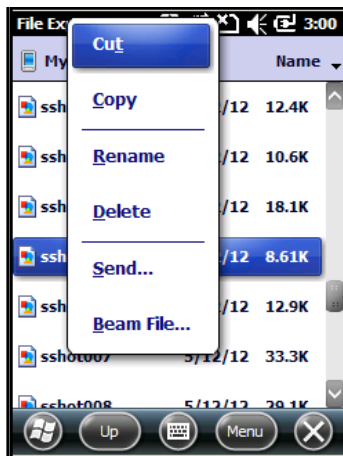

Figure 7-7 File Explorer Window

6. Select **Beam File**. The MC45 searches for Bluetooth devices in the area.
7. Tap **Tap to send** next to the Bluetooth device to send the file to. The MC45 communicates with the device and send the file. When completed, **Tap to send** changes to **Done**.

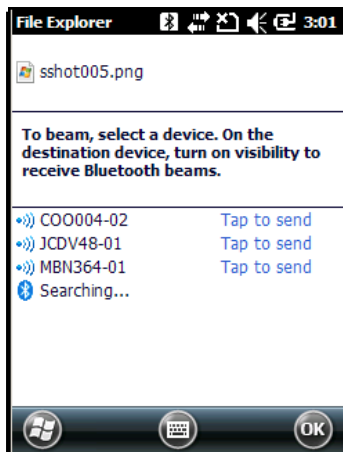

Figure 7-8 Beam File Window

To transfer a contact between the MC45 and another Bluetooth enabled device:

1. Ensure that Bluetooth is enabled and discoverable on both devices.
2. Ensure that the two devices are within 30 feet (10 meters) of one another.
3. Tap **Start > Contacts**
4. Navigate to the contact to transfer.
5. Tap and hold on the contact until the pop-up menu appears.



Figure 7-9 Contact Window

6. Select **Send Contact > Beam**. The MC45 searches for Bluetooth devices in the area.
7. Tap **Tap to send** next to the Bluetooth device to send the file to. The MC45 communicates with the device and send the contact. When completed, **Tap to send** changes to **Done**.

Internet Sharing

Internet Sharing allows the user to connect a computer or laptop to the MC45 and use the MC45 as a modem to connect to an office network or ISP.

To use MC45 as a modem using Bluetooth:

1. Ensure that the device is not connected to the computer or laptop.
2. On the MC45, ensure that the Phone is on and a data connection is configured.
3. Tap **Start > Internet Sharing**.
4. In the **PC Connection** list, select **Bluetooth PAN**.
5. In the **Network Connection** list, select the connection type.
Select the network connection that the device should use to connect to the Internet.
6. Tap **Connect**.
7. On the computer or laptop, setup a Bluetooth PAN with your device.
 - a. Select **Start > Control Panel > Network Connections**.
 - b. Under **Personal Area Network**, select **Bluetooth Network Connection**.
 - c. Right-click on **Bluetooth Network Connection** and select **View Bluetooth** network devices.
 - d. In the **Bluetooth Personal Area Network Devices** window select your device.
 - e. Click **Connect**. The computer connects to the device via Bluetooth.

✓ **NOTE** If your computer is Bluetooth-enabled and you select Bluetooth as the PC connection, you must initiate and complete the Bluetooth PAN partnership before Internet Sharing will work. For more information, refer to Windows Help and Support.

8. To verify, on the PC or laptop, launch **Internet Explorer** and open a web site.
9. To end dial-up networking, on the MC45 tap **Disconnect**.

Hands-free Services

To connect to a Bluetooth headset:

✓ **NOTE** Newer Bluetooth headsets are device dependant and remember the last device they connected to. If problems occur while connecting to the headset, place the headset in discovery mode. Refer to the headset user manual for more information.

Only WAN audio is routed to the headset. System audio is still emitted through the MC45 speaker.

You can accept calls and re-dial using the Hands-free profile.

1. Ensure that Bluetooth is enabled and discoverable on both devices.
2. Ensure that the two devices are within 30 feet (10 meters) of one another.
3. Tap **Start > Settings > Connections > Wireless Manager > Menu > Bluetooth Settings > Devices**.
4. Tap **New device**. The MC45 searches for Bluetooth devices in the area.
5. Select the headset name and tap **Next**. The Passcode window appears.
6. Enter the headset's passcode.
7. Tap **Next**. The MC45 connects to the headset. Refer to the headset user manual for instructions on communicating with a Bluetooth device.

Serial Port Services

Use the wireless Bluetooth serial port connection as you would a physical serial cable connection. Configure the application that will use the connection to the correct serial port.

To establish a serial port connection:

1. Ensure that Bluetooth is enabled and discoverable on both devices.
2. Ensure that the two devices are within 30 feet (10 meters) of one another.
3. Tap **Start > Settings > Bluetooth > Devices**.
4. Tap **Add new device**. The MC45 begins searching for discoverable Bluetooth devices in the area.
5. Select a device from the list.
6. Tap **Next**. The **Enter Passcode** window appears.
7. Enter the Passcode and the tap **Next**. The device is added to the Bluetooth list.
8. In the device list, tap the serial device. The **Partnership Settings** window displays.
9. Select the **Serial Port** checkbox.
10. Tap **Save**.
11. Tap **COM Ports** tab.
12. Tap **New Outgoing Port**. The add device window appears.
13. Select the serial device in the list and then tap **Next**.
14. Select a COM port from the drop-down list.
15. Tap **Finish**.

✓ **NOTE** No connection is made at this point. An application must open the selected COM port to trigger Microsoft Bluetooth stack to open the connection.

ActiveSync Using Serial Port Services

Use the wireless Bluetooth serial port connection for ActiveSync just as you would a physical serial cable connection. You must configure the application that will use the connection to the correct serial port.

To set up a Bluetooth ActiveSync connection:

Before setting up a Bluetooth ActiveSync connection, configure the Bluetooth function of your device.

✓ **NOTE** For additional security, disable network bridging on the computer (specifically, bridging to a Remote NDIS adapter) before connecting to the computer to pass through to the Internet or a network. For more information on network bridging, see **Windows Help** on your computer.

The instructions below are for computers that support the Windows XP SP2 or later version operating system.

1. Ensure that Bluetooth is enabled and discoverable on both devices.
2. Ensure that the two devices are within 30 feet (10 meters) of one another.
3. On the computer, click **Start > Settings > Control Panel**.

4. Double-click **Bluetooth Devices**.
5. On the **Options** tab, select the **Turn discovery on** and **Allow Bluetooth devices to connect to this computer** checkboxes.

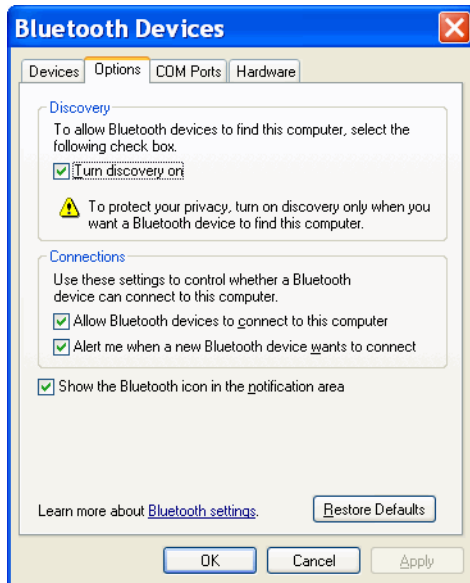

Figure 7-10 Computer Bluetooth Devices Window

6. On the **COM Ports** tab, click **Add**.
7. Select the **Incoming (device initiates the connection)** option, then click **OK**.
Note the number of the COM port that was added.
8. Click **OK**.
9. Click **Start > All Programs > Microsoft ActiveSync**.
10. Click **File > Connection Settings**.



Figure 7-11 ActiveSync Connection Settings

11. On the **Allow connections to one of the following** drop-down list, select the COM port with the number you noted earlier.
12. On the MC45, tap **Start > ActiveSync**.

13. Tap **Menu > Connect via Bluetooth**.

Synchronization is automatically initiated. The **ActiveSync** icon appears on the lower right corner of the **Today** screen.

If an Authentication is required, the **Enter Passcode** screen appears, type an alphanumeric passkey (PIN code), then tap **Next**; enter the same passkey on the other device.

The passkey is recommended for enhanced security. Your passkey must be between 1 to 16 alphanumeric characters.

If you do not want to use a passkey, tap **Next**.

14. To disconnect the ActiveSync connection, tap **My Apps > Active Sync**.

15. Tap **Disconnect**.

Phone Book Access Profile Services

Phone Book Access profile (PBAP) is used to synchronize contacts between a remote device and the MC45. To establish an PBAP synchronization:

1. Ensure that Bluetooth is enabled and discoverable on both devices.
2. Ensure that the two devices are within 30 feet (10 meters) of one another.
3. Tap **Start > Settings > Bluetooth > Devices**.
4. Tap **Add New Device**. The MC45 searches for a Bluetooth device, such as a Car Kit.
5. Select a device from the list.
6. Tap **Next**. The **Enter Passcode** window appears.
7. Enter the Passcode and the tap **Next**. The device is added to the Bluetooth list.
8. A dialog box appears requesting if you want to transfer contacts to the car kit.
9. Select **Yes** or **No**.
10. If **Yes** is selected, contacts from the MC45 are transferred to the car kit.

Dial-Up Networking Services

Dial-up networking allows the user to connect a PC or laptop to the MC45 and use the MC45 as a modem to connect to an office network or ISP.

Before setting up dial-up networking, obtain dial-up information and other necessary settings (username, password and domain name, if required) for the office network or ISP. To create a new Bluetooth connection:

1. Ensure the MC45 is discoverable and connectable.
2. On the PC or laptop, set up Bluetooth according to the manufacturer's instructions.
3. On the PC or laptop Bluetooth software, search for the MC45 and select the Dial-up Networking service.
4. Using dial-up software on the PC or laptop, connect to the MC45.
5. The MC45 phone function dials the ISP number and connects to the ISP.
6. To verify, on the PC or laptop, launch Internet Explorer and open a web site.

Connect to a HID Device

The MC45 can connect to an Human Interface Device (HID) device such as a Bluetooth keyboard or mouse:

1. Ensure that Bluetooth is enabled on both devices.
2. Ensure that the Bluetooth device to discover is in discoverable and connectable modes.
3. Ensure that the two devices are within 30 feet (10 meters) of one another.
4. Tap **Start > Settings > Bluetooth > Devices**.
5. Tap **Add new device**. The MC45 begins searching for discoverable Bluetooth devices in the area.
6. Select a HID device from the list.
7. Tap **Next**. The **Enter Passcode** window appears. Refer to the device's User Manuals for more information.
8. Tap **Connect**. The MC45 connects to the HID device.

A2DP/AVRCP Services

A2DP/AVRCP is used to connect to a high-quality stereo headset:

1. Ensure that Bluetooth is enabled on both devices.
2. Ensure that the Bluetooth device to discover is in discoverable and connectable modes.
3. Ensure that the two devices are within 30 feet (10 meters) of one another.
4. Tap **Start > Settings > Bluetooth > Devices**.
5. Tap **Add new device**. The MC45 begins searching for discoverable Bluetooth devices in the area.
6. Select a stereo headset from the list.
7. Tap **Next**. The **Enter Passcode** window appears. Refer to the device's User Manuals for more information.
8. Tap **Connect**. The MC45 connects to the stereo headset.

For stereo headsets that can use hands-free services, connect to the hands-free service after connecting to the A2DP service:

1. Tap **Start > Settings > Bluetooth > Devices**.
2. Tap **Add new device**. The MC45 begins searching for discoverable Bluetooth devices in the area.
3. Select a stereo headset from the list.
4. Tap **Next**. The **Enter Passcode** window appears. Refer to the device's User Manuals for more information.



NOTE If Smart-pairing is configured and the device is requesting one of the pre-defined PINs, the **Enter Passcode** window does not appear.

5. Tap **Connect**. The MC45 connects to the stereo headset.

Chapter 8 Accessories

Introduction

MC45 accessories, listed below, provide a variety of product support capabilities.

Table 8-1 *MC45 Accessories*

Accessory	Part Number	Description
Cradles		
Single Slot Charge Cradle	CRDMC45-1000CR	Charges the MC45 device.
Multi Slot Universal Charge Only Cradle	CRDUNIV-XX-5000R	Charges five MC45 devices simultaneously or four MC45 devices when configured with a Four Slot Battery Charger. Charger Cups and Power Supplies sold separately.
Multi Slot Universal Charge Only Cradle with five MC45 cups installed	CRDUNIV-45-5000R	Charges five MC45 devices simultaneously or four MC45 devices when configured with a Four Slot Battery Charger. Includes 5 Charger Cups. Power Supply sold separately.
Vehicle Charge Cradle	VCD45XX-1000R	Installs in a vehicle and charges the MC45 battery.
Chargers		
Four Slot Battery Charger	SAC45XX-4000CR	Charges four MC45 batteries simultaneously.
Cables		
Auto Charge Cable	VCA400-01R	Charges the MC45 using a vehicle's cigarette lighter.
DEX Cable	25-45793-01R	For use with electronic data exchange. For example, connecting MC45 to a vending machine.
USB Rapid Charge Cable	25-128458-01R	Charges the MC45 and provides USB communication with a host computer.
Miscellaneous		
Power Supply	PWRS-124306-01R	Provides power to the MC45 or Single Slot Charge Cradle using the USB Rapid Charge Cable.

Table 8-1 MC45 Accessories (Continued)

Accessory	Part Number	Description
Power Supply	PWRS-14000-148C	Provides power to the Multi Slot Universal Charge Only Cradle or the Four Slot Battery Charger.
Spare 3080 mAh lithium-ion battery	BTRY-MCXX-3080-01R	Replacement 3080 mAh battery.
	BTRY-MCXX-3080-10R	Package of 10 replacement 3080 mAh batteries
	BTRY-MCBR-3080-01R	Replacement 3080 mAh battery for Brazil only.
MC45 Battery Door	KT-MC45-BTRYD-01R	Replacement battery door.
Mount Bracket	KT-UNIVLBRKT-01R	Mount bracket for rack or wall mounting of the Multi Slot Universal Charge Only Cradle.
Charger Cup	CUPMC45XX-1000R	Charger cup for the Multi Slot Universal Charge Only Cradle.
Blank Slot Cover	CUPUNICVR-5000R	Package of 5 blank slot covers for the Multi Slot Universal Charge Only Cradle charge slot.
Four Slot Battery Charger Cup Adapter	CUPUNIBTRY-1000R	Mounts the Four Slot Battery Charger onto the Multi Slot Universal Charge Only Cradle.
Handstrap	SG-MC45-STRAP-01R	Single pivot handstrap.
Soft Holster	SG-MC45-HLSTR-01R	Soft case holder for added protection.
Stylus with Tether Kit	KT-MC45-STYTH-10R	Replacement Stylus and Tether (10-pack)
micro USB adapter	ADP45XX-100R	Rugged micro USB adapter that connects to the MC45 micro USB port.
Screen Protector	KT-MC45-SCRNP-10R	Package of 10 screen protectors.

USB Rapid Charge Cable

Use the USB Rapid Charge cable to connect the MC45 to the power supply for charging or to a host computer for communication.

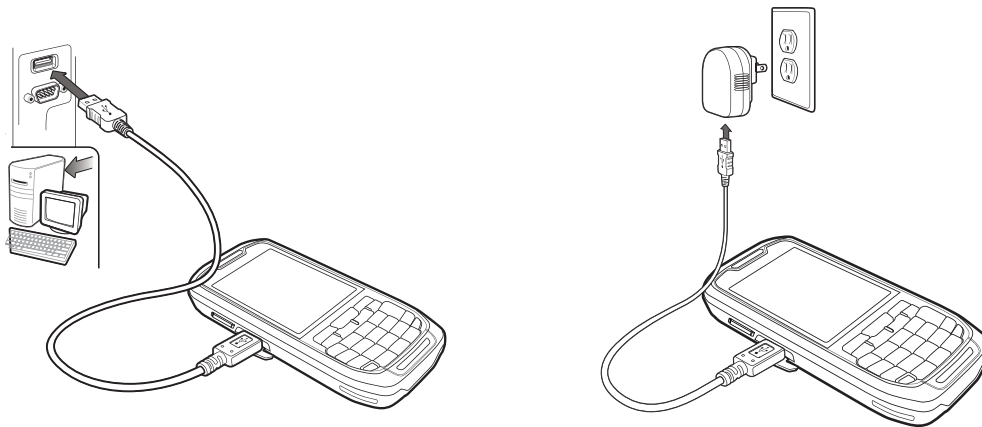

Figure 8-1 *USB Rapid Charge Cable*

Communication with Host Computer

To communicate with a host computer:

1. Ensure ActiveSync is installed and configured on the host computer. See [ActiveSync on page 8-13](#) for more information.
2. Connect USB Rapid Charge cable to the micro USB port on the side of the MC45.
3. Connect the USB connector of the USB Rapid Charge Cable to the USB Port on the host computer.
4. The **USB Connect** dialog box appears.
5. Tap **ActiveSync RNDIS** or **ActiveSync Serial**.
6. Tap **Connect**.

Single Slot Charge Cradle

Charging the MC45 Battery

To charge the MC45 battery:

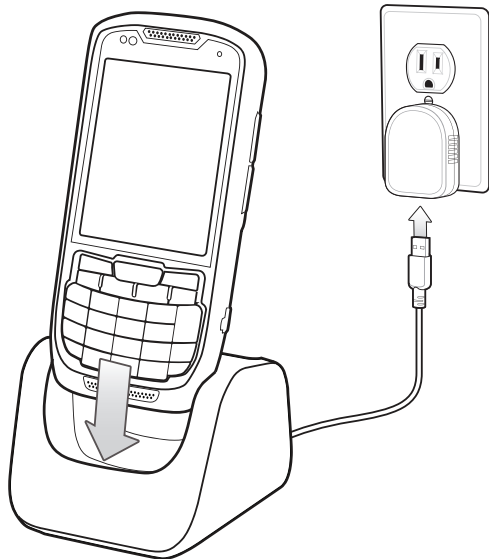

Figure 8-2 Charging the MC45 Using the Single Slot Charge Cradle

1. Place the MC45 into the cradle.

The MC45's LED indicates the status of the battery charging in the MC45. See [Table 1-1 on page 1-7](#) for charging status indications. The 3080mAh battery fully charges in less than six hours at room temperature of approximately 25 °C (77°F). Charging time may vary at different temperatures.

Multi Slot Universal Charge Only Cradle

- ✓ **NOTE** The Multi Slot Universal Charge Only Cradle charges five MC45 devices simultaneously or four MC45 devices when configured with a Four Slot Battery Charger.

To charge the MC45 batteries:

1. Place the MC45 into the cradle.

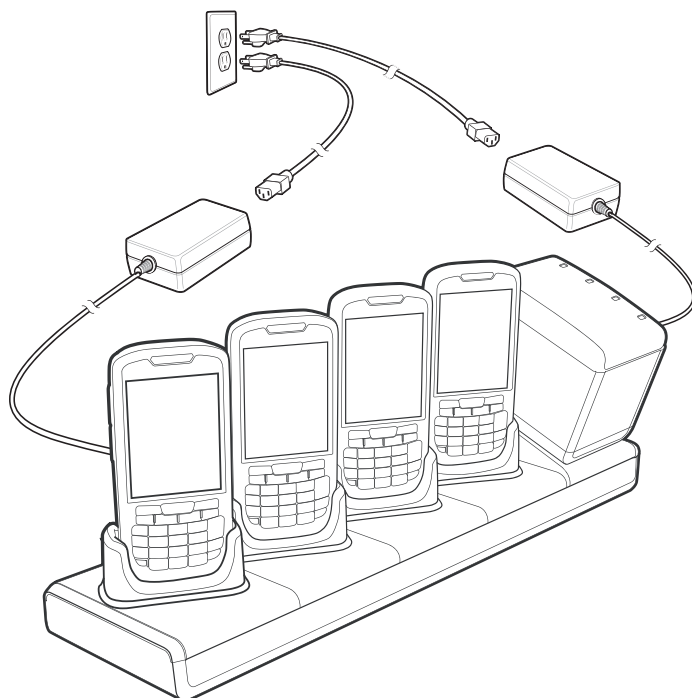

Figure 8-3 Multi Slot Universal Charge Only Cradle

- ✓ **NOTE** The Four Slot Battery Charger can be attached to the Multi Slot Universal Charge Only Cradle using a Battery Charger Cup Adapter. The cup adapter angles the Battery Charger so that the user can see the LED indicators easily.

The Four Slot Battery Charger requires a separate power supply. See [Four Slot Battery Charger on page 8-10](#) for more information

The MC45's LED indicates the status of the battery charging in the MC45. See [Table 1-1 on page 1-7](#) for charging status indications. The 3080mAh battery fully charges in less than six hours at room temperature of approximately 25 °C (77°F). Charging time may vary at different temperatures.

Charging Temperature

Charge batteries in temperatures from 0°C to 40°C (32°F to 104°F). Charging is intelligently controlled by the MC45.

To accomplish this, for small periods of time, the MC45 or accessory alternately enables and disables battery charging to keep the battery at acceptable temperatures. The MC45 or accessory indicates when charging is disabled due to abnormal temperatures via its LED. See [Table 1-1 on page 1-7](#).

Vehicle Charge Cradle



WARNING! Some countries prohibit the mounting of any electronic device in any location on the vehicle dashboard. Be sure to check with local laws acceptable mounting areas before installing the auto mounting kit.

Install the vehicle mount on the surface of the vehicle that is reasonably flat and free of dirt and oil. Clean the mounting surface with a glass cleaner and a clean cotton cloth. Install the vehicle mount on the windshield or other flat car surface using the supplied mounting disc.

Windshield Installation

1. Fix the suction cup mount to the selected area with the suction lever facing up.

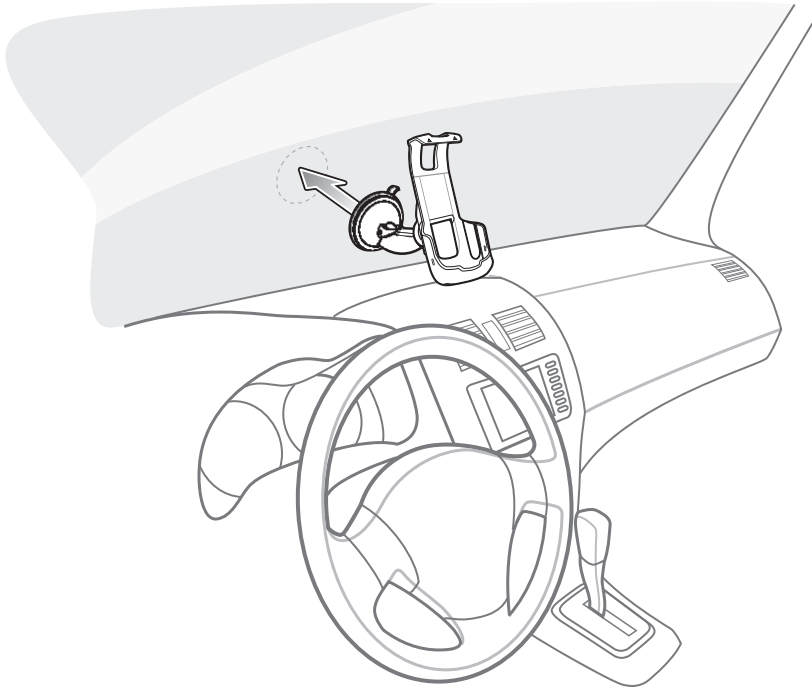

Figure 8-4 *Install on Windshield*

2. Flip the lever down to create a vacuum between the suction cup and the mounting surface.

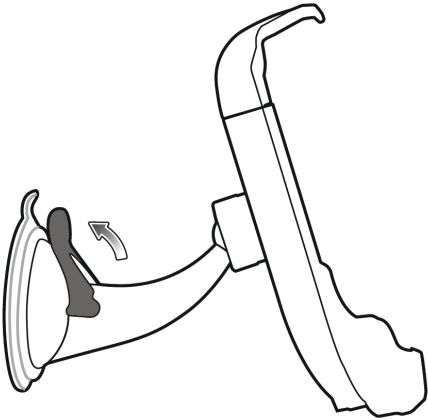

Figure 8-5 *Move lever Toward Windshield*

3. Make sure that the suction bond is strong enough before proceeding to the next step.

Install the MC45

To install the MC45 into the Vehicle Charge Cradle:

1. Place the MC45 top first into the cradle.
2. Push the MC45 back until it snaps into place.

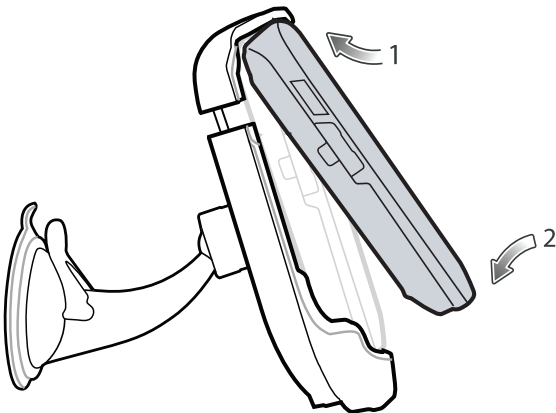

Figure 8-6 *Insert MC45 into Vehicle Charge Cradle*

3. Position the MC45 for best viewing.
4. Tighten the nuts to lock the cradle in place.

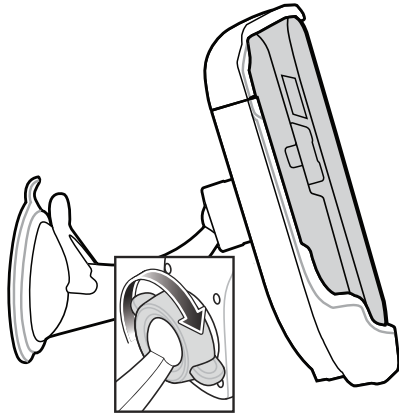

Figure 8-7 *Tighten Nut*

Connect Power

To connect power to the Vehicle Charge Cradle:

1. If required, connect the micro USB connector of the auto charger to the input power connector in the Vehicle Charge Cradle.

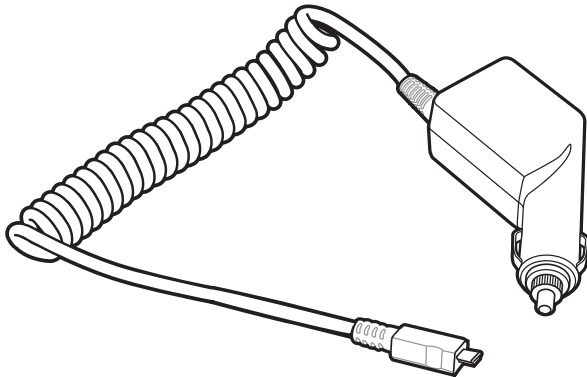

Figure 8-8 *Commercial Grade Auto Charger*

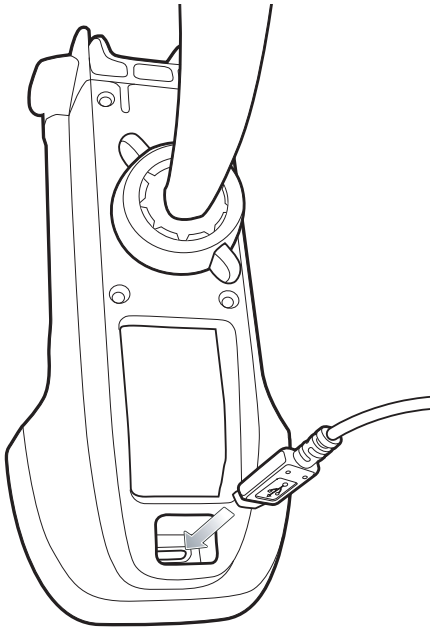

Figure 8-9 Connect Auto Charge Cable to Vehicle Charge Cradle

2. Connect the other end to the cigarette lighter socket.

The LED indicator flashes green indicating the MC45 is charging.

Remove the MC45

To remove the MC45 from the Vehicle Charge Cradle lift the MC45 up and then remove from the bottom of the cradle.

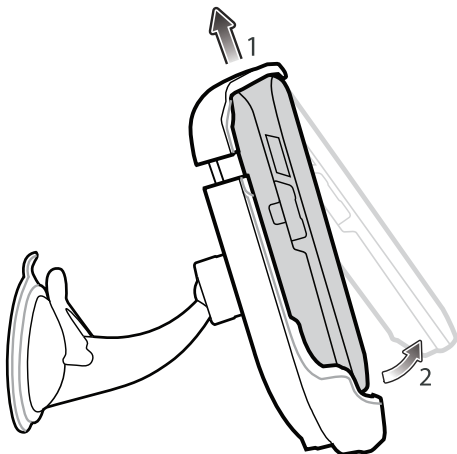

Figure 8-10 Remove MC45 from Vehicle Charge Cradle

Four Slot Battery Charger

To charge the MC45 batteries:

1. Connect the charger to a power source.
2. Insert the spare battery into a spare battery charging well and gently press down on the battery to ensure the battery is safely locked under the latch.

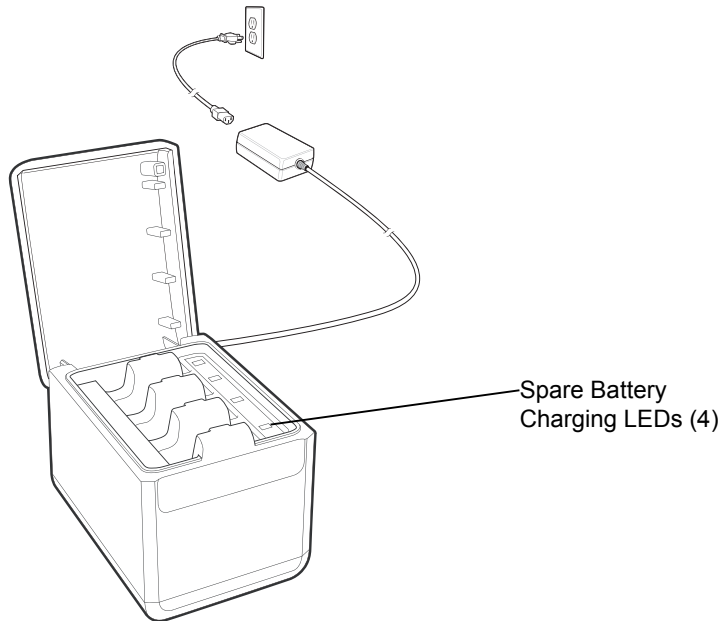

Figure 8-11 Four Slot Battery Charger

To remove the spare battery from the Four Slot Battery Charger:

1. Gently push the battery located in the spare battery charging well towards the back of the charger. The latch unlocks.
2. Remove the battery by pulling it upwards from the spare battery charging well.



NOTE The Four Slot Battery Charger is compatible and charges the 3080 mAh lithium-ion battery (p/n BTRY-MCXX-3080-01R, BTRY-MCXX-3080-10R and BTRY-MCBR-3080-01R).

Battery Charging Indicators

The charger has a green LED for each battery charging well. See [Table 8-2](#) for charging status indications. The 3080 mAh battery fully charges in less than six hours at room temperature of approximately 25 °C (77°F). Charging time may vary at different temperatures.

Charging Temperature

Charge batteries in temperatures from 0°C to 40°C (32°F to 104°F). Charging is intelligently controlled by the Four Slot Battery Charger.

To accomplish this, for small periods of time, the charger alternately enables and disables battery charging to keep the battery at acceptable temperatures. The charger indicates when charging is disabled due to abnormal temperatures via its LED. See [Table 1-1 on page 1-7](#).

Table 8-2 Spare Battery LED Charging Indicators

LED	Indication
Off	No spare battery in slot; battery is not charging; battery is not inserted correctly in the charger; charger is not powered.
Slow Blinking Green	Spare battery is charging.
Solid Green	Charging complete.
Fast Blinking Red	Charging error.

micro USB Adapter

Use the micro USB Adapter to connect accessory devices (such as printers or USB flash drives) to the MC45. The micro USB Adapter connects the DEX cable to the MC45.

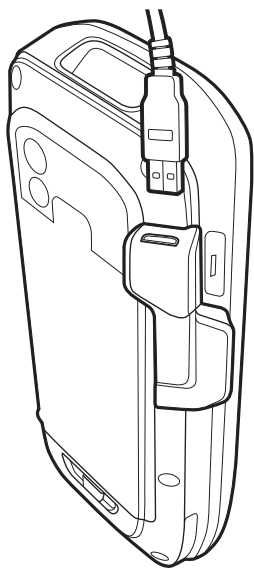
**Figure 8-12** micro USB Adapter Connection

- ✓ **NOTE** The micro USB Adapter can only be connected to the MC45 and not the Single Slot Charge Cradle.

The micro USB Adapter is intended to provide extension of the MC45 micro USB port. Use the micro USB Adapter to minimize mechanical wear and failures of the MC45.

Connect an accessory device's USB connector to the micro USB Adapter.

- ✓ **NOTE** When connecting a USB Flash drive to the micro USB Adapter, the USB Flash Drive appears in **File Explorer** as **Hard Drive** under **My Device** folder.

Handstrap

The handstrap allows the MC45 to be worn safely around the palm of your hand. To install the handstrap:

1. Remove the 2 screws securing the existing tether plate from the MC45.
2. Untie the tether from the tether plate.
3. Tie the tether to the handstrap plate.
4. Install the handstrap plate to the MC45.

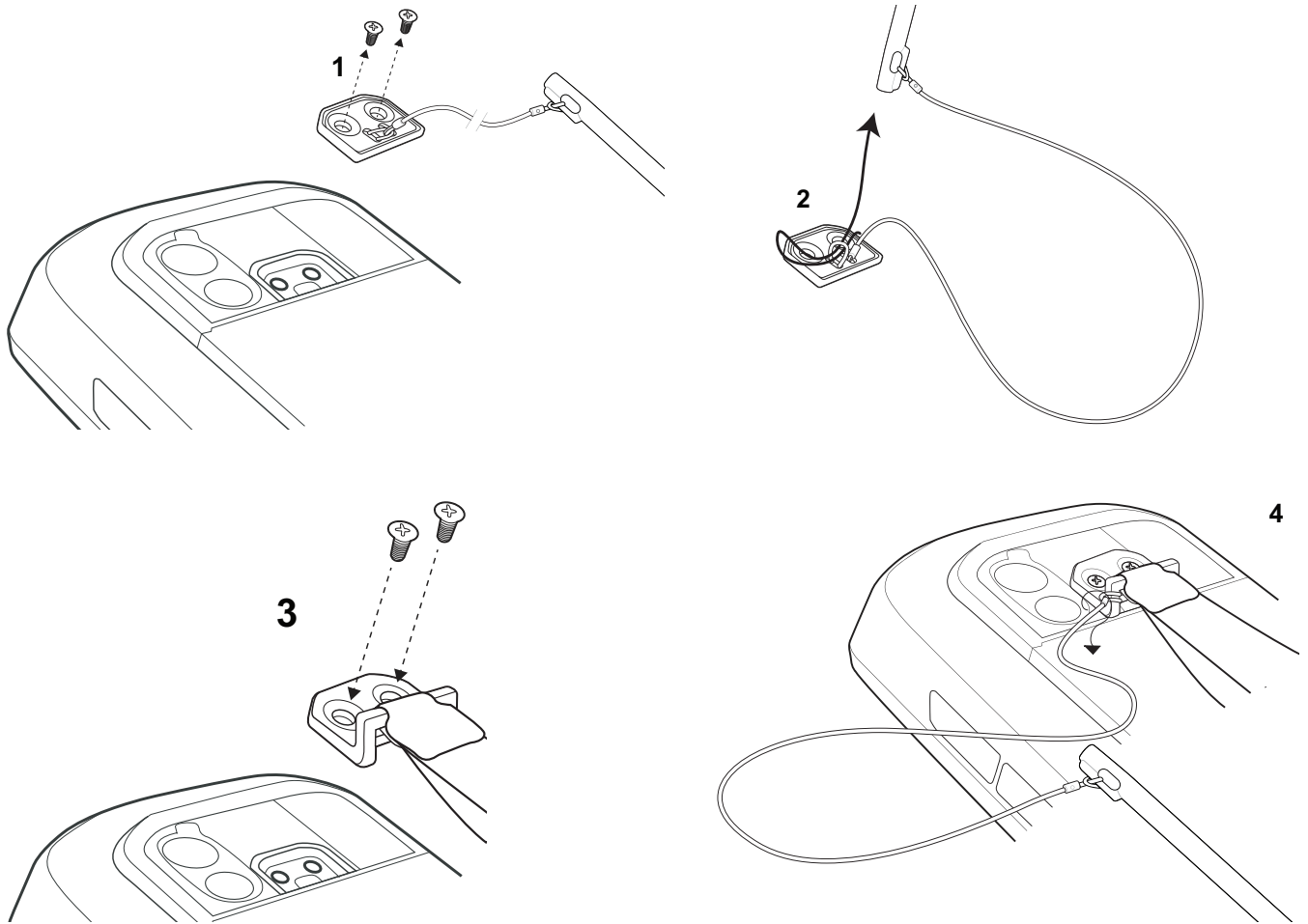

Figure 8-13 *Installing the Handstrap*

ActiveSync

To communicate with various host devices, install Microsoft ActiveSync (version 4.5 or higher) on the host computer. Use ActiveSync to synchronize information on the MC45 with information on the host computer. Changes made on the MC45 or host computer appear in both places after synchronization.

- ✓ **NOTE** When the MC45 is connected to a host computer and an ActiveSync connection is made, the WLAN radio is disabled. This is a Microsoft security feature to prevent connection to two networks at the same time.

ActiveSync software:

- Allows working with mobile computer-compatible host applications on the host computer. ActiveSync replicates data from the mobile computer so the host application can view, enter, and modify data on the mobile computer.
- Synchronizes files between the mobile computer and host computer, converting the files to the correct format.
- Backs up the data stored on the mobile computer. Synchronization is a one-step procedure that ensures the data is always safe and up-to-date.
- Copies (rather than synchronizes) files between the mobile computer and host computer.
- Controls when synchronization occurs by selecting a synchronization mode, e.g., set to synchronize continually while the mobile computer is connected to the host computer, or set to only synchronize on command.
- Selects the types of information to synchronize and control how much data is synchronized.

Installing ActiveSync

To install ActiveSync on the host computer, download version 4.5 or higher from the Microsoft web site at <http://www.microsoft.com>. Refer to the installation procedures included with the ActiveSync software.

MC45 Setup

- ✓ **NOTE** Microsoft recommends installing ActiveSync on the host computer before connecting the MC45.

The MC45 can be set up to communicate with a USB connection. The MC45 communication settings must be set to match the communication settings used with ActiveSync.

1. On the MC45 tap **Start > ActiveSync**.
2. Tap **Menu > Connections**.
3. Select the connection type from the drop-down list.
4. Tap **OK** to exit the **Connections** window
5. Tap **OK** to exit the **ActiveSync** window.
6. Proceed with setting up a partnership with a host computer with ActiveSync installed.

Setting Up an ActiveSync Connection on the Host Computer

To start ActiveSync:

1. Select **Start > Programs > Microsoft ActiveSync** on the host computer.

✓ **NOTE** Assign each MC45 a unique device name. Do not try to synchronize more than one MC45 to the same name.

2. In the **ActiveSync** window, select **File > Connection Settings**. The **Connection Settings** window appears.
3. Select **Allow USB connections** check box.
4. Select the **Show status** icon in **Taskbar** check box.
5. Select **OK** to save any changes made.

Synchronization with the MC45

✓ **NOTE** When the MC45 is connected to a host computer and an ActiveSync connection is made, the WLAN radio (if applicable) is disabled. This is a Microsoft security feature to prevent connection to two networks at the same time.

To synchronize with the MC45:

1. If the **Get Connected** window does not appear on the host computer, select **Start > Active Sync** and then click **Next**.
2. Select the check box to synchronize with a server running Microsoft Exchange if applicable and then click **Next**.
3. Select the appropriate settings and click **Next** and then click **Finish**.

During the first synchronization, information stored on the MC45 is copied to the host computer. When the copy is complete and all data is synchronized, the MC45 can be disconnected from the host computer.

✓ **NOTE** The first ActiveSync operation must be performed with a local, direct connection. Windows Mobile retains partnerships information after a cold boot.

For more information about using ActiveSync, start ActiveSync on the host computer, then see **ActiveSync Help**.

Chapter 9 Maintenance & Troubleshooting

Introduction

This chapter includes instructions on cleaning and storing the MC45, and provides troubleshooting solutions for potential problems during MC45 operation.

Maintaining the MC45

For trouble-free service, observe the following tips when using the MC45:

- Do not scratch the screen of the MC45. When working with the MC45, use the supplied stylus or plastic-tipped pens intended for use with a touch-sensitive screen. Never use an actual pen or pencil or other sharp object on the surface of the MC45 screen.
- A screen protector, p/n KT-MC45-SCRNP-10R, is applied to the MC45. Zebra recommends using this to minimize wear and tear. Screen protectors enhance the usability and durability of touch screen displays. Benefits include:
 - Protection from scratches and gouges
 - Durable writing and touch surface with tactile feel
 - Abrasion and chemical resistance
 - Glare reduction
 - Keeping the device's screen looking new
 - Quick and easy installation.
- The touch-sensitive screen of the MC45 is polycarbonate. Do not to drop the MC45 or subject it to strong impact.
- Protect the MC45 from temperature extremes. Do not leave it on the dashboard of a car on a hot day, and keep it away from heat sources.
- Do not store or use the MC45 in any location that is dusty, damp, or wet.
- Use a soft lens cloth to clean the MC45. If the surface of the MC45 screen becomes soiled, clean it with a soft cloth moistened with a diluted window-cleaning solution.

- Periodically replace the rechargeable battery to ensure maximum battery life and product performance. Battery life depends on individual usage patterns.

Removing the Screen Protector

A screen protector is applied to the MC45. Zebra recommends using this to minimize wear and tear. Screen protectors enhance the usability and durability of touch screen displays.

To remove the screen protector, lift the corner using a thin plastic card, such as a credit card, then carefully lift it off the display.

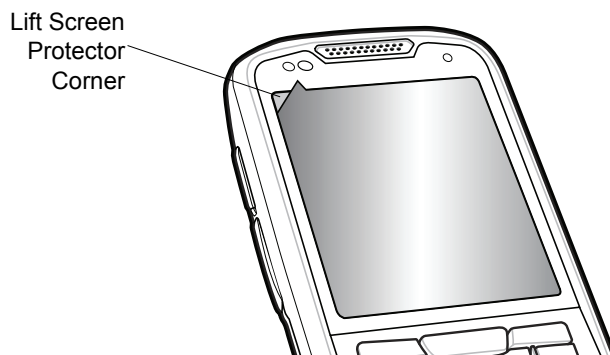

Figure 9-1 *Removing the Screen Protector*



CAUTION Do not use a sharp object to remove the protector. Doing so can damage the display.



NOTE Not using a screen protector can affect warranty coverage. To purchase replacement protectors, contact your local account manager or Zebra. These include screen protector installation instructions. Part number: KT-MC45-SCRNP-10R Screen Protector 10/pk.

Battery Safety Guidelines

- The area in which the units are charged should be clear of debris and combustible materials or chemicals. Particular care should be taken where the device is charged in a non commercial environment.
- Follow battery usage, storage, and charging guidelines found in the user's guide.
- Improper battery use may result in a fire, explosion, or other hazard.
- To charge the mobile device battery, the battery and charger temperatures must be between +32 °F and +104 °F (0 °C and +40 °C)
- Do not use incompatible batteries and chargers. Use of an incompatible battery or charger may present a risk of fire, explosion, leakage, or other hazard. If you have any questions about the compatibility of a battery or a charger, contact Zebra Global Customer Support.
- For devices that utilize a USB port as a charging source, the device shall only be connected to products that bear the USB-IF logo or have completed the USB-IF compliance program.
- To enable authentication of an approved battery, as required by IEEE1725 clause 10.2.1, all batteries will carry a Zebra hologram. Do not fit any battery without checking it has the Zebra authentication hologram.
- Do not disassemble or open, crush, bend or deform, puncture, or shred.
- Severe impact from dropping any battery-operated device on a hard surface could cause the battery to overheat.
- Do not short circuit a battery or allow metallic or conductive objects to contact the battery terminals.
- Do not modify or remanufacture, attempt to insert foreign objects into the battery, immerse or expose to water or other liquids, or expose to fire, explosion, or other hazard.
- Do not leave or store the equipment in or near areas that might get very hot, such as in a parked vehicle or near a radiator or other heat source. Do not place battery into a microwave oven or dryer.
- Battery usage by children should be supervised.
- Please follow local regulations to promptly dispose of used re-chargeable batteries.
- Do not dispose of batteries in fire.
- Seek medical advice immediately if a battery has been swallowed.
- In the event of a battery leak, do not allow the liquid to come in contact with the skin or eyes. If contact has been made, wash the affected area with large amounts of water and seek medical advice.
- If you suspect damage to your equipment or battery, contact Zebra Global Customer Support to arrange for inspection.

Cleaning



WARNING! Avoid exposing this product to contact with hot oil or other flammable liquids. If such exposure occurs, unplug the device and clean the product immediately in accordance with these guidelines.



CAUTION Always wear eye protection.

Read warning label on compressed air and alcohol product before using.

If you have to use any other solution for medical reasons please contact Zebra for more information.

Materials Required

- Alcohol wipes
- Lens tissue

- Cotton tipped applicators
- Isopropyl alcohol
- Can of compressed air with a tube.

Cleaning the MC45

Housing

Using the alcohol wipes, wipe the housing including keys and in-between keys.

Display

The display can be wiped down with the alcohol wipes, but care should be taken not to allow any pooling of liquid around the edges of the display. Immediately dried the display with a soft, non-abrasive cloth to prevent streaking.

Scanner Exit Window

Wipe the scanner exit window periodically with a lens tissue or other material suitable for cleaning optical material such as eyeglasses.

Connector

1. Remove the main battery from mobile computer. See [Replacing the Battery on page 1-8](#).
2. Close battery door.
3. Dip the cotton portion of the cotton tipped applicator in isopropyl alcohol.
4. Rub the cotton portion of the cotton tipped applicator back-and-forth across the connector on the bottom of the MC45. Do not leave any cotton residue on the connector.
5. Repeat at least three times.
6. Use the cotton tipped applicator dipped in alcohol to remove any grease and dirt near the connector area.
7. Use a dry cotton tipped applicator and repeat steps 4 through 6.



CAUTION Do not point nozzle at yourself and others, ensure the nozzle or tube is away from your face.

8. Spray compressed air on the connector area by pointing the tube/nozzle about ½ inch away from the surface.
9. Inspect the area for any grease or dirt, repeat if required.

Cleaning Cradle Connectors

To clean the connectors on a cradle:

1. Remove the DC power cable from the cradle.
2. Dip the cotton portion of the cotton tipped applicator in isopropyl alcohol.
3. Rub the cotton portion of the cotton tipped applicator along the pins of the connector. Slowly move the applicator back-and-forth from one side of the connector to the other. Do not let any cotton residue on the connector.

- All sides of the connector should also be rubbed with the cotton tipped applicator.



CAUTION Do not point nozzle at yourself and others, ensure the nozzle or tube is away from your face.

- Spray compressed air in the connector area by pointing the tube/nozzle about ½ inch away from the surface.
- Ensure that there is no lint left by the cotton tipped applicator, remove lint if found.
- If grease and other dirt can be found on other areas of the cradle, use lint free cloth and alcohol to remove.
- Allow at least 10 to 30 minutes (depending on ambient temperature and humidity) for the alcohol to air dry before applying power to cradle.

If the temperature is low and humidity is high, longer drying time is required. Warm temperature and dry humidity requires less drying time.

Cleaning Frequency

The cleaning frequency is up to the customer's discretion due to the varied environments in which the mobile devices are used. They may be cleaned as frequently as required. However when used in dirty environments it may be advisable to periodically clean the scanner exit window to ensure optimum scanning performance.

Troubleshooting

MC45

Table 9-1 Troubleshooting the MC45

Problem	Cause	Solution
MC45 does not turn on.	Battery not charged.	Charge or replace the battery.
	Battery not installed properly.	Install the battery properly. See <i>Installing the Battery on page 1-5</i> .
	System crash.	Perform a warm boot. If the MC45 still does not turn on, perform a cold boot. See <i>Resetting the MC45 on page 2-17</i> .
Rechargeable battery did not charge.	Battery failed.	Replace battery. If the MC45 still does not operate, perform a warm boot, then a cold boot. See <i>Resetting the MC45 on page 2-17</i> .
	MC45 removed from cradle while battery was charging.	Insert MC45 in cradle and allow to charge.
	Extreme battery temperature.	Battery does not charge if ambient temperature is below 0°C (32°F) or above 40°C (104°F).
Cannot see characters on display.	MC45 not powered on.	Press the red Power button.

Table 9-1 Troubleshooting the MC45 (Continued)

Problem	Cause	Solution
During data communication, no data transmitted, or transmitted data was incomplete.	MC45 removed from cradle or disconnected from host computer during communication.	Replace the MC45 in the cradle, or reattach the communication cable and re-transmit.
	Incorrect cable configuration.	See the system administrator.
	Communication software was incorrectly installed or configured.	Perform setup. Refer to the <i>MC45 Integrator Guide</i> for details.
No sound.	Volume setting is low or turned off.	Adjust the volume. See Adjusting Volume on page 2-14 .
MC45 shuts off.	MC45 is inactive.	The MC45 turns off after a period of inactivity. If the MC45 is running on battery power, set this period from 1 to 5 minutes, in one-minute intervals. If the MC45 is running on external power, set this period to 1, 2, 5, 10, 15, or 30 minutes. Check the Power window by selecting Start > Settings > Power icon. Select the Advanced tab and change the setting for a longer delay before the automatic shutoff feature activates.
	Battery is depleted.	Recharge or replace the battery.
	Battery is not inserted properly.	Insert the battery properly. See Installing the Battery on page 1-5 .
Tapping the window buttons or icons does not activate the corresponding feature.	Screen is not calibrated correctly.	Re-calibrate the screen. See Calibrating the Screen on page 1-8 .
	The system is not responding.	Warm boot the system. See Resetting the MC45 on page 2-17 .
A message appears stating that the MC45 memory is full.	Too many files stored on the MC45.	Delete unused memos and records. If necessary, save these records on the host computer (or use a microSD card for additional memory).
	Too many applications installed on the MC45.	Remove user-installed applications on the MC45 to recover memory. Select Start > Settings > System and tap the Remove Programs icon. Select the unused program and tap Remove .
MC45 keeps powering down to protect memory contents.	The MC45's battery is low.	Recharge or replace the battery. Configure the MC45 to conserve power. Refer to Battery Management on page 1-10 for more information.

Table 9-1 Troubleshooting the MC45 (Continued)

Problem	Cause	Solution
The MC45 does not accept data capture input.	Scanning application is not loaded.	Load a scanning application on the MC45. See the system administrator.
	Unreadable bar code.	Ensure the symbol is not defaced.
	Distance between exit window and bar code is incorrect.	Place the MC45 within proper scanning range.
	MC45 is not programmed for the bar code.	Program the MC45 to accept the type of bar code being scanned.
	MC45 is not programmed to generate a beep.	If the MC45 does not beep on a good decode, set the application to generate a beep on good decode.
	Battery is low.	If the scanner stops emitting a laser beam upon a trigger press, check the battery level. When the battery is low, the scanner shuts off before the MC45 low battery condition notification. Note: If the scanner is still not reading symbols, contact the distributor or Zebra.
Phone service is not available with SIM card installed.	SIM card might not be installed properly.	Re-install SIM card and ensure that it is seated properly. See Installing the mini-SIM Card on page 1-4 .
Error message "SIM Error. Cannot save info to SIM" appears when copying contacts to a SIM card.	Feature not supported on some SIM cards.	If error appears while creating a new contact, add at least one number (e.g. 0) to the Work Phone field.
		If error appears while copying one contact, reboot the MC45. The contact appears on the SIM card after rebooting.
		If error appears while copying multiple contacts, copy one contact at a time and follow the above solution.
		Use Microsoft Outlook Exchange and ActiveSync to synchronize contacts with Microsoft Outlook on host computer.
MC45 cannot find any Bluetooth devices nearby.	Too far from other Bluetooth devices.	Move closer to the other Bluetooth device(s), within a range of 10 meters.
	The Bluetooth device(s) nearby are not turned on.	Turn on the Bluetooth device(s).
	The Bluetooth device(s) are not in discoverable mode.	Set the Bluetooth device(s) to discoverable mode. If needed, refer to the device's user documentation for help.

Single Slot Charge Cradle

Table 9-2 *Troubleshooting the Single Slot Charge Cradle*

Symptom	Possible Cause	Action
LEDs do not light when MC45 is inserted.	Cradle is not receiving power.	Ensure the power cable is connected securely to both the cradle and to AC power.
	MC45 is not seated firmly in the cradle.	Remove and re-insert the MC45 into the cradle, ensuring it is firmly seated.
MC45 battery is not charging.	MC45 was removed from cradle or cradle was unplugged from AC power too soon.	Ensure cradle is receiving power. Ensure MC45 is seated correctly. Confirm battery is charging under Start > Settings > Power .
	Battery is faulty.	Verify that other batteries charge properly. If so, replace the faulty battery.
	The MC45 is not fully seated in the cradle.	Remove and re-insert the MC45 into the cradle, ensuring it is firmly seated.
	Ambient temperature of the cradle is too warm.	Move the cradle to an area where the ambient temperature is between 0°C (32°F) and 35°C (95°F).
	Extreme battery temperature.	Battery does not charge if ambient temperature is below 0°C (32°F) or above 40°C (104°F).

Multi Slot Universal Charge Only Cradle

Table 9-3 Troubleshooting the Multi Slot Universal Charge Only Cradle

Symptom	Possible Cause	Action
LEDs do not light when MC45 is inserted.	Cradle is not receiving power.	Ensure the power cable is connected securely to both the cradle and to AC power.
	MC45 is not seated firmly in the cradle.	Remove and re-insert the MC45 into the cradle, ensuring it is firmly seated.
MC45 battery is not charging.	MC45 was removed from cradle or cradle was unplugged from AC power too soon.	Ensure cradle is receiving power. Ensure MC45 is seated correctly. Confirm battery is charging under Start > Settings > Power .
	Battery is faulty.	Verify that other batteries charge properly. If so, replace the faulty battery.
	The MC45 is not fully seated in the cradle.	Remove and re-insert the MC45 into the cradle, ensuring it is firmly seated.
	Ambient temperature of the cradle is too warm.	Move the cradle to an area where the ambient temperature is between 0°C (32°F) and 35°C (95°F).
	Extreme battery temperature.	Battery does not charge if ambient temperature is below 0°C (32°F) or above 40°C (104°F).

Vehicle Charge Cradle

Table 9-4 Troubleshooting the Vehicle Charge Cradle

Symptom	Possible Cause	Action
LEDs do not light up when MC45 is inserted	Cradle is not receiving power.	Ensure the power input cable is securely connected to the cradle's power port.
MC45 battery is not charging.	MC45 was removed from the cradle too soon.	Replace the MC45 in the cradle.
	Battery is faulty.	Replace the battery.

Table 9-4 Troubleshooting the Vehicle Charge Cradle (Continued)

Symptom	Possible Cause	Action
	MC45 is not placed correctly in the cradle.	Remove the MC45 from the cradle, and re-insert correctly. If the battery still does not charge, contact customer support. The MC45 battery charging LED slowly blinks amber when the MC45 is correctly inserted and charging.
	Ambient temperature of the cradle is too warm.	Move the cradle to an area where the ambient temperature is between 0°C (32°F) and 35°C (95°F).
	MC45 removed from cradle during communication.	Replace MC45 in cradle and retransmit.

Four Slot Battery Charger

Table 9-5 Troubleshooting the Four Slot Battery Charger

Symptom	Possible Cause	Action
LEDs do not light when MC45 is inserted.	Charger is not receiving power.	Ensure the power cable is connected securely to both the charger and to AC power.
	MC45 battery is not seated firmly in the charger.	Remove and re-insert the MC45 battery into the charging well, ensuring it is firmly seated.
MC45 battery is not charging.	Battery was removed from the charger or charger was unplugged from AC power too soon.	Re-insert the battery in the charger or re-connect the charger's power supply.
	Battery is faulty.	Verify that other batteries charge properly. If so, replace the faulty battery.
	Battery contacts not connected to charger.	Verify that the battery is seated in the charging well correctly with the contacts facing down.
	Ambient temperature of the cradle is too warm.	Move the charger to an area where the ambient temperature is between 0°C (32°F) and 35°C (95°F).

Cables

Table 9-6 *Troubleshooting the Cables*

Symptom	Possible Cause	Action
MC45 battery is not charging.	MC45 was disconnected from AC power too soon.	Connect the power cable correctly. Confirm main battery is charging under Start > Settings > Power .
	Battery is faulty.	Verify that other batteries charge properly. If so, replace the faulty battery.
	The MC45 is not fully attached to power.	Detach and re-attach the power cable to the MC45, ensuring it is firmly connected.
During data communication, no data transmits, or transmitted data was incomplete.	Cable was disconnected from MC45 during communications.	Re-attach the cable and retransmit.
	Incorrect cable configuration.	See the system administrator.
	Communication software is not installed or configured properly.	Perform setup as described in the <i>MC45 Integrator Guide</i> .

Appendix A Technical Specifications

MC45 Technical Specifications

The following tables summarize the MC45's intended operating environment and technical hardware specifications.

Table A-1 *MC45 Technical Specifications*

Item	Description
Physical Characteristics	
Dimensions	Length: 14.2 cm (5.6 in.) Width: 6.6 cm (2.6 in.) Depth: 2.5 cm (1.0 in.)
Weight	247.4 g (8.73 oz)
Display	16 bit color 3.2" QVGA with backlight, TFT-LCD, 65K colors, 240 W x 320 L (QVGA size)
Touch Panel	Polycarbonate analog resistive touch
Backlight	LED backlight
Battery	Rechargeable Lithium Ion 3.7V, 3080 mAh battery
Expansion Slot	User accessible microSD slot with UHS-I SDHC support up to 32GB
Network Connections	USB 2.0 High Speed (host and client), WLAN, WWAN and Bluetooth
Notification	Vibrator and audible tone plus multi-color LED
Keypad Options	Numeric
Audio	VoWWAN: handset mode with active noise reduction, speaker phone mode, Bluetooth wireless headset mode
Performance Characteristics	
CPU	600 MHz, ARM 11 processor, MSM 7627

Table A-1 MC45 Technical Specifications (Continued)

Item	Description
Operating System	Microsoft® Windows Embedded Handheld™ 6.5.3 Professional Edition
Memory	256 MB RAM / 1GB Flash
Interface/Communications	USB 2.0
Output Power	USB: 5 VDC @ 300mA max.
User Environment	
Operating Temperature	-10°C to 50°C (14°F to 122°F)
Storage Temperature	-40°C to 70°C (-40°F to 158°F)
Charging Temperature	0°C to 40°C (32°F to 104°F)
Humidity	5% to 95% non-condensing
Drop Specification	Multiple 1.5 m (5 ft.) drop per MIL-STD 810G Multiple 0.9 m (3 ft.) drop to concrete, over operating temperature range
Tumble	250, 0.5 m (1.5 ft.) tumbles with standard batteries installed; per applicable IEC tumble specifications
Electrostatic Discharge (ESD)	+/-15kVdc air discharge, +/-8kVdc direct discharge, +/-8kVdc indirect discharge
Sealing	IP64 per applicable IEC sealing specifications
Vibration	.04g2/Hz Random, Non-Operating, 1 hour duration per axis
Thermal Shock	-40°C to 70°C rapid transition
Wireless WAN Data and Voice Communications	
Radio	GSM and UMTS/HSDPA
Frequency Band	GSM – All Models Quad Band : 850 / 900 / 1800 / 1900 MHz UMTS/HSDPA – MC4597-A and MC4587-A : 2100 MHz UMTS/HSDPA – MC4597-B: 850 / 1900 MHz
GPS	Integrated, Autonomous and Assisted-GPS (A-GPS)
Wireless LAN Data and Voice Communications	
Radio	MC4597-A and MC4597-B: Tri-mode IEEE® 802.11a/b/g
Data Rates Supported	1, 2, 5.5, 6, 9, 11, 12, 18, 24, 36, 48, and 54 Mbps
Operating Channels	Chan 8-169 (5040 – 5845 MHz) Chan 1-13 (2412-2472 MHz) Chan 14 (2484 MHz) Japan only Actual operating frequencies depend on regulatory rules and certification agency

Table A-1 MC45 Technical Specifications (Continued)

Item	Description
Security	WPA2, WEP (40 or 128 bit), TKIP, TLS, TTLS (MS-CHAP), TTLS (MS-CHAP v2), TTLS (CHAP), TTLS-MD5, TTLS-PAP, PEAP-TLS, PEAP (MS-CHAP v2), AES, LEAP, CCXv4 certified; FIPS 140-2 certified
Spreading Technique	Direct Sequence Spread Spectrum (DSSS) and Orthogonal Frequency Division Multiplexing (OFDM)
Antenna	Internal
Wireless PAN Data and Voice Communications	
Bluetooth	Class II, V2.0 with EDR
Data Capture Specifications	
Options	1D laser, color camera
Laser 1D Scanner (SE965) Specifications	
Optical Resolution	0.005 in. minimum element width
Roll	+/- 35° from vertical
Pitch Angle	+/- 65° from normal
Skew Tolerance	+/- 40° from normal
Ambient Light	Tolerant to typical artificial indoor and natural outdoor (direct sunlight) lighting conditions. Fluorescent, Incandescent, Mercury Vapor, Sodium Vapor, LED : 450 Ft Candles (4,844 Lux) Sunlight: 8000 Ft Candles (86,111 Lux)
Shock	2,000 +/- 5% G
Scan Rate	50 (+/- 6) scans/sec (bidirectional)
Scan Angle	46.5° (typical)
Laser Power	1.0 mW nominal
Camera Specifications	
Resolution	3.2 Mega pixel with auto focus and flash

Table A-2 Data Capture Options

Item	Description
Camera Decode Capability	1-D Bar Codes Codabar Code 93 Coupon Code EAN 13 Korean 3 of 5 RSS 14 Trioptic Code 29 UPCE
	Code 11 Code 128 Discrete 2 of 5 Interleaved 2 of 5 MSI RSS Limited UCC / EAN 128 UPCE1
	Code 39 Chinese 2 of 5 EAN 8 ISBT 128 RSS RSS Expanded UPCA Web Code
	2-D Bar Codes Australian Postal Composite C Image Macro Micro PRF PDF UK Postal US Postnet
	Aztec Data Matrix Japan Postal Micro PDF QR Code UK Intellimail
	Composite AB Dutch Postal Linked Aztec Micro QR Signature US Planet

MC45 Accessory Specifications

Single Slot Charge Cradle

Table A-3 Single Slot Charge Cradle Technical Specifications

Feature	Description
Dimensions	Length: 9.6 cm (3.8 in.) Width: 8.30 cm (3.3 in.) Height: 6.8 cm (2.7 in.)
Weight	245 g (8.6 oz)
Input Power	5 VDC
Power Consumption	6 watts
Interface	USB
Operating Temperature	0°C to 40°C (32°F to 104°F)
Storage Temperature	-40°C to 70°C (-40°F to 158°F)
Charging Temperature	0°C to 40°C (32°F to 104°F)

Table A-3 Single Slot Charge Cradle Technical Specifications (Continued)

Feature	Description
Humidity	5% to 95% non-condensing
Drop	76 cm (30.0 in.) drops to vinyl tiled concrete at room temperature
Electrostatic Discharge (ESD)	+/- 15 kV air +/- 8 kV contact

Multi Slot Universal Charge Only Cradle

Table A-4 Multi Slot Universal Charge Only Cradle Technical Specifications

Feature	Description
Dimensions (Base only)	Length: 12.0 cm (4.7 in.) Width: 45.0 cm (17.7 in.) Height: 3.8 cm (1.5 in.) Height: 4.4 cm (1.7 in.) with 5 rubber caps
Dimensions (Base with 5 Charger Cups)	Length: 12.0 cm (4.7 in.) Width: 45.0 cm (17.7 in.) Height: 7.7 cm (3.0 in.)
Dimensions (Base with 4 Charger Cups and 1 Four Slot Battery Charger Cup Adapter)	Length: 12.0 cm (4.7 in.) Width: 45.0 cm (17.7 in.) Height: 7.7 cm (3.0 in.)
Weight (Base only)	910 g (32.10 oz) 930 g (32.80 oz) with 5 rubber caps
Weight (Base with 5 Charger Cups)	1190 g (41.98 oz)
Weight (Base with 4 Charger Cups and 1 Four Slot Battery Charger Cup Adapter)	1670 g (58.91 oz)
Input Power	12 VDC
Power Consumption (with 5 MC45s)	37.5 watts
Operating Temperature	0°C to 40°C (32°F to 104°F)
Storage Temperature	-40°C to 70°C (-40°F to 158°F)
Charging Temperature	0°C to 40°C (32°F to 104°F)
Humidity	5% to 95% non-condensing
Drop	76 cm (30.0 in.) drops to vinyl tiled concrete at room temperature
Electrostatic Discharge (ESD)	+/- 15 kV air +/- 8 kV contact

Four Slot Battery Charger

Table A-5 *Four Slot Battery Charger Technical Specifications*

Feature	Description
Dimensions	Length: 11.9 cm (4.7 in.) Width: 8.7 cm (3.4 in.) Height: 9.4 cm (3.7 in.)
Weight	366 g (12.91 oz)
Input Power	12 VDC
Power Consumption	25.1 watts
Operating Temperature	0°C to 40°C (32°F to 104°F)
Storage Temperature	-40°C to 70°C (-40°F to 158°F)
Charging Temperature	0°C to 40°C (32°F to 104°F)
Humidity	5% to 95% non-condensing
Drop	76 cm (30.0 in.) drops to vinyl tiled concrete at room temperature
Electrostatic Discharge (ESD)	+/- 15 kV air +/- 8 kV contact

Appendix B Keypads

Numeric Keypad Configuration

The numeric keypad contains application keys, scroll keys, and function keys. The keypad is color-coded to indicate the alternate function key (blue) values. Note that an application can change keypad functions so the MC45's keypad may not function exactly as described. See [Table B-1](#) for key and button descriptions and [Table B-2 on page B-4](#) for the keypad's special functions.



Figure B-1 MC45 Numeric Keypad

Table B-1 MC45 Numeric Keypad Descriptions











Key	Description
<p>Blue Key (left)</p> 	<p>Use this key to access function keys shown on the keypad in blue. Press the Blue key once to activate this mode, followed by another key.</p> <p>A single press illuminates the key and displays the following icon  at the bottom of the screen until a second key is pressed: Press the Blue key twice to lock the keypad in the blue keys mode. This displays the following icon  at the bottom of the screen. Press the Blue key again to return to the normal state.</p>
<p>Orange Key</p> 	<p>Use this key to access the secondary layer of characters and actions shown on the keypad in orange. Press the Orange key once to activate this mode, followed by another key.</p> <p>A single press illuminates the key and displays the following icon  at the bottom of the screen until a second key is pressed: Press the Orange key twice to lock the keypad in the orange keys mode. This displays the following icon  at the bottom of the screen. Press the Orange key twice, then press the Shift key to add a permanent shift (that applies until the Shift is pressed again). This displays the following icon  at the bottom of the screen. Press the Orange key again to return to the normal state.</p>
<p>Talk / Start Menu</p> 	<p>Talk (Green Phone): press to display the phone keypad window or to dial a phone number (from the phone keypad window). When on a phone call, press to place the call on hold. Use this key in conjunction with the Blue key to instantly display the <i>Start</i> menu from any application without tapping the screen. This function is user programmable.</p>
<p>End / OK</p> 	<p>End (Red Phone) : press when the phone keypad window displays to stop dialing or end a call. Use this key in conjunction with the Blue Key as an OK or close button. This function is user programmable.</p>
<p>Scan (yellow)</p> 	<p>Activates the scanner in a scan enabled application.</p>
<p>Scroll Up and Down / Scroll Left and Right</p> 	<p>Moves up one item. Moves left one item when pressed with the Orange key. Moves down one item. Moves right one item when pressed with the Orange key.</p>

Table B-1 MC45 Numeric Keypad Descriptions (Continued)









Key	Description
Star / Backlight 	Produces a dash in default state. Produces an asterisk when pressed with the Orange key. Use this key in conjunction with the Blue Key to toggle the backlight on or off.
Alphanumeric 	In default state, produces the numeric value on the key. When pressed with the Orange key, produces the lower case alphabetic characters on the key. Each key press produces the next alphabetic character in sequence. For example, press and release the Orange key and then press the '4' key once to produce the letter 'g'; press and release the Orange key and then press the '4' key three times to produce the letter 'i'. Press the SHIFT key in Alpha state to produce the upper case alphabetic characters on the key. For example, press and release the Orange key, press and release the SHIFT key, and then press the '4' key once to produce the letter 'G'; press and release the Orange key, press and release the SHIFT key and then press the '4' key three times to produce the letter 'I'.
Pound / SPACE 	Produces a pound / number in default state. Produces a space when pressed with the Orange key.
BACKSPACE 	Produces a backspace.
SHIFT 	Press and release the SHIFT key to activate the keypad alternate SHIFT functions. A single press displays the following icon  at the bottom of the screen, until a second key is pressed: Press the Shift key twice to lock the keypad in the Shift mode. This displays the following icon  at the bottom of the screen. Press the Orange key twice, then press the Shift key to add a permanent shift (that applies until the Shift is pressed again). This displays the following icon  at the bottom of the screen.
ENT (Enter) 	Executes a selected item or function.

Table B-2 *Numeric Keypad Input Modes*

Key	Numeric Mode			Orange Key (Alpha Lowercase Mode)				Orange + Shift Keys (Alpha Uppercase Mode)			
		Blue+ Key	SHIFT + Key	1st Press	2nd Press	3rd Press	4th Press	1st Press	2nd Press	3rd Press	4th Press
1	1	F1	!								
2	2	F2	@	a	b	c		A	B	C	
3	3	F3	#	d	e	f		D	E	F	
4	4	F4	\$	g	h	i		G	H	I	
5	5	F5	%	j	k	l		J	K	L	
6	6	F6	^	m	n	o		M	N	O	
7	7	F7	&	p	q	r	s	P	Q	R	S
8	8	F8	*	t	u	v		T	U	V	
9	9	F9	(w	x	y	z	W	X	Y	Z
0	0	F10)	.				>			
Up	Up	Up	Hilight Up	Left				Left			
Down	Down	Down	Hilight Down	Right				Right			
Enter	Action	Action	Action	Action				Action			

Note: An application can change the key functions. The keypad may not function exactly as described.

Special Character Key

To add special characters using the MC45 **áü** key, press the Orange key twice first then type the related character followed by the **áü (P)** key. Continue pressing the **áü** key until the special character displays. To modify an existing character, move the cursor to the right of the character then press the Orange key twice and then press the **áü** key until the special character replaces the original character. [Table B-3](#) lists the special characters you can generate.

Table B-3 *Special Characters*

Key	Special Characters	Key	Special Characters
a	à á â ã ä å æ	A	À Á Â Ã Ä Å Æ
c	ç ć ċ ©	C	Ç Ć Ć ©
d	đ	D	Ð
e	è é ê ë ě	E	È É Ê Ë Ě
i	ì í î ï	I	Ì Í Î Ï

Table B-3 Special Characters (Continued)

Key	Special Characters		Key	Special Characters
l	ł		L	Ł ł
n	ñ		N	Ñ
o	ò ó ô õ ö ø œ		O	Ò Ó Ô Õ Ö Ø Æ
p	þ		P	Þ
r	®		R	®
s	ş š ß		S	Ş Š ß
t	ţ		T	Ț
u	ù ú û ü		U	Ù Ú Û Ü
y	ý		Y	Ý
z	ź ź		Z	Ź Ź
\$	€ £ ¥		/	\\
"	' « ' »		([{ < «
)] } > »		+	± & - _
!	¡ ? ¿		.	: ;
*	#		@	~ %
%	^		,	; . :
#	*		&	- _ + ±
_	+ ± & -		'	« » "
?	¿ ! ¡		:	; ; .
-	_ + ± &			

Glossary

A

API. An interface by means of which one software component communicates with or controls another. Usually used to refer to services provided by one software component to another, usually via software interrupts or function calls

Application Programming Interface. See **API**.

AKU. (Adaptation Kit Update) Updates to the Windows Mobile operating system.

AFH. Adaptive Frequency Hopping.

ActiveSync. ActiveSync is a data synchronization program developed by Microsoft for use with Windows Mobile operating systems.

B

Bar. The dark element in a printed bar code symbol.

Bar Code. A pattern of variable-width bars and spaces which represents numeric or alphanumeric data in machine-readable form. The general format of a bar code symbol consists of a leading margin, start character, data or message character, check character (if any), stop character, and trailing margin. Within this framework, each recognizable symbology uses its own unique format. See **Symbology**.

Bar Code Density. The number of characters represented per unit of measurement (e.g., characters per inch).

Bit. Binary digit. One bit is the basic unit of binary information. Generally, eight consecutive bits compose one byte of data. The pattern of 0 and 1 values within the byte determines its meaning.

Bits per Second (bps). Bits transmitted or received.

boot or boot-up. The process a computer goes through when it starts. During boot-up, the computer can run self-diagnostic tests and configure hardware and software.

bps. See **Bits Per Second**.

Byte. On an addressable boundary, eight adjacent binary digits (0 and 1) combined in a pattern to represent a specific character or numeric value. Bits are numbered from the right, 0 through 7, with bit 0 the low-order bit. One byte in memory is used to store one ASCII character.

C

Codabar. A discrete self-checking code with a character set consisting of digits 0 to 9 and six additional characters (“-”, “\$”, “:”, “/”, “,” and “+”).

Code 128. A high density symbology which allows the controller to encode all 128 ASCII characters without adding extra symbol elements.

Code 3 of 9 (Code 39). A versatile and widely used alphanumeric bar code symbology with a set of 43 character types, including all uppercase letters, numerals from 0 to 9 and 7 special characters (“-”, “:”, “/”, “+”, “%”, “\$” and space). The code name is derived from the fact that 3 of 9 elements representing a character are wide, while the remaining 6 are narrow.

Code 93. An industrial symbology compatible with Code 39 but offering a full character ASCII set and a higher coding density than Code 39.

COM port. Communication port; ports are identified by number, e.g., COM1, COM2.

Cradle. A cradle is used for charging the terminal battery and for communicating with a host computer, and provides a storage place for the terminal when not in use.

D

Decode. To recognize a bar code symbology (e.g., UPC/EAN) and then analyze the content of the specific bar code scanned.

Discrete 2 of 5. A binary bar code symbology representing each character by a group of five bars, two of which are wide. The location of wide bars in the group determines which character is encoded; spaces are insignificant. Only numeric characters (0 to 9) and START/STOP characters may be encoded.

E

EAN. European Article Number. This European/International version of the UPC provides its own coding format and symbology standards. Element dimensions are specified metrically. EAN is used primarily in retail.

EMDK. Enterprise Mobility Developer’s Kit.

ESD. Electro-Static Discharge

F

File Transfer Protocol (FTP). A TCP/IP application protocol governing file transfer via network or telephone lines. See **TCP/IP**.

FTP. See **File Transfer Protocol**.

G

GPS (Global Positioning System). A satellite-based navigation system made up of a network of 24 satellites. GPS satellites circle the earth and transmit signal information to earth. GPS receivers take this information and use triangulation to calculate the user's exact location.

H

Hz. Hertz; A unit of frequency equal to one cycle per second.

Host Computer. A computer that serves other terminals in a network, providing such services as computation, database access, supervisory programs and network control.

High-Speed Downlink Packet Access (HSDPA). A 3G (third generation) mobile telephony communications protocol in the High-Speed Packet Access (HSPA) family, which allows networks based on Universal Mobile Telecommunications System (UMTS) to have higher data transfer speeds and capacity.

I

Interleaved 2 of 5. A binary bar code symbology representing character pairs in groups of five bars and five interleaved spaces. Interleaving provides for greater information density. The location of wide elements (bar/spaces) within each group determines which characters are encoded. This continuous code type uses no intercharacter spaces. Only numeric (0 to 9) and START/STOP characters may be encoded.

Internet Protocol Address. See **IP**.

IP. Internet Protocol. The IP part of the TCP/IP communications protocol. IP implements the network layer (layer 3) of the protocol, which contains a network address and is used to route a message to a different network or subnetwork. IP accepts "packets" from the layer 4 transport protocol (TCP or UDP), adds its own header to it and delivers a "datagram" to the layer 2 data link protocol. It may also break the packet into fragments to support the maximum transmission unit (MTU) of the network.

IP Address. (Internet Protocol address) The address of a computer attached to an IP network. Every client and server station must have a unique IP address. A 32-bit address used by a computer on a IP network. Client workstations have either a permanent address or one that is dynamically assigned to them each session. IP addresses are written as four sets of numbers separated by periods; for example, 204.171.64.2.

L

LASER. Light Amplification by Stimulated Emission of Radiation. The laser is an intense light source. Light from a laser is all the same frequency, unlike the output of an incandescent bulb. Laser light is typically coherent and has a high energy density.

laser scanner. A type of bar code reader that uses a beam of laser light.

LCD. See **Liquid Crystal Display**.

LED Indicator. A semiconductor diode (LED - Light Emitting Diode) used as an indicator, often in digital displays. The semiconductor uses applied voltage to produce light of a certain frequency determined by the semiconductor's particular chemical composition.

Light Emitting Diode. See **LED**.

Liquid Crystal Display (LCD). A display that uses liquid crystal sealed between two glass plates. The crystals are excited by precise electrical charges, causing them to reflect light outside according to their bias. They use little electricity and react relatively quickly. They require external light to reflect their information to the user.

M

MC. Mobile Computer.

MDN. Mobile Directory Number. The directory listing telephone number that is dialed (generally using POTS) to reach a mobile unit. The MDN is usually associated with a MIN in a cellular telephone -- in the US and Canada, the MDN and MIN are the same value for voice cellular users. International roaming considerations often result in the MDN being different from the MIN.

Mobile Computer. In this text, *mobile computer* refers to the MC45. It can be set up to run as a stand-alone device, or it can be set up to communicate with a network, using wireless radio technology.

N

Nominal. The exact (or ideal) intended value for a specified parameter. Tolerances are specified as positive and negative deviations from this value.

Nominal Size. Standard size for a bar code symbol. Most UPC/EAN codes are used over a range of magnifications (e.g., from 0.80 to 2.00 of nominal).

NVM. Non-Volatile Memory.

P

PAN . Personal area network. Using Bluetooth wireless technology, PANs enable devices to communicate wirelessly. Generally, a wireless PAN consists of a dynamic group of less than 255 devices that communicate within about a 33-foot range. Only devices within this limited area typically participate in the network.

Parameter. A variable that can have different values assigned to it.

PING. (Packet Internet Groper) An Internet utility used to determine whether a particular IP address is online. It is used to test and debug a network by sending out a packet and waiting for a response.

R

RAM. Random Access Memory. Data in RAM can be accessed in random order, and quickly written and read.

Reset. Restarts the mobile computer by closing all running programs. All data that is not saved to flash memory is lost.

Resolution. The narrowest element dimension which is distinguished by a particular reading device or printed with a particular device or method.

RF. Radio Frequency.

ROM. Read-Only Memory. Data stored in ROM cannot be changed or removed.

Router. A device that connects networks and supports the required protocols for packet filtering. Routers are typically used to extend the range of cabling and to organize the topology of a network into subnets. See **Subnet**.

S

Scanner. An electronic device used to scan bar code symbols and produce a digitized pattern that corresponds to the bars and spaces of the symbol. Its three main components are: 1) Light source (laser or photoelectric cell) - illuminates a bar code,; 2) Photodetector - registers the difference in reflected light (more light reflected from spaces); 3) Signal conditioning circuit - transforms optical detector output into a digitized bar pattern.

Shared Key. Shared Key authentication is an algorithm where both the AP and the MU share an authentication key.

Subnet. A subset of nodes on a network that are serviced by the same router. See **Router**.

Subnet Mask. A 32-bit number used to separate the network and host sections of an IP address. A custom subnet mask subdivides an IP network into smaller subsections. The mask is a binary pattern that is matched up with the IP address to turn part of the host ID address field into a field for subnets. Default is often 255.255.255.0.

Symbology. The structural rules and conventions for representing data within a particular bar code type (e.g. UPC/EAN, Code 39, PDF417, etc.).

T

TCP/IP. (Transmission Control Protocol/Internet Protocol) A communications protocol used to interconnect dissimilar systems. This standard is the protocol of the Internet and has become the global standard for communications. TCP provides transport functions, which ensures that the total amount of bytes sent is received correctly at the other end. UDP is an alternate transport that does not guarantee delivery. It is widely used for real-time voice and video transmissions where erroneous packets are not retransmitted. IP provides the routing mechanism. TCP/IP is a routable protocol, which means that all messages contain not only the address of the destination station, but the address of a destination network. This allows TCP/IP messages to be sent to multiple networks within an organization or around the world, hence its use in the worldwide Internet. Every client and server in a TCP/IP network requires an IP address, which is either permanently assigned or dynamically assigned at startup.

Terminal. See **Mobile Computer**.

Tolerance. Allowable deviation from the nominal bar or space width.

Transmission Control Protocol/Internet Protocol. See **TCP/IP**.

U

UDP. User Datagram Protocol. A protocol within the IP protocol suite that is used in place of TCP when a reliable delivery is not required. For example, UDP is used for real-time audio and video traffic where lost packets are simply ignored, because there is no time to retransmit. If UDP is used and a reliable delivery is required, packet sequence checking and error notification must be written into the applications.

UPC. Universal Product Code. A relatively complex numeric symbology. Each character consists of two bars and two spaces, each of which is any of four widths. The standard symbology for retail food packages in the United States.

Index

Numerics

- 1-D bar codes 3-1
- 1-D laser scanner xii

A

- A2DP/AVRCP 7-14
- accessories
 - auto charge cable 8-1
 - battery door 8-2
 - blank slot cover 8-2
 - charger cup 8-2
 - DEX cable 8-1
 - four slot battery charger 8-1, 8-10
 - four slot battery charger cup adapter 8-2
 - handstrap 8-2
 - micro USB adapter 8-2, 8-11
 - microSD card 1-3
 - mount bracket 8-2
 - multi slot universal charge only cradle 1-6, 8-1, 8-5
 - multi slot universal charge only cradle with five MC45 cups installed 8-1
 - power supply 8-1
 - screen protector 8-2
 - SIM card 1-4
 - single slot charge cradle 1-6, 8-1, 8-4
 - soft holster 8-2
 - spare battery 8-2
 - specifications A-4
 - stylus with tether kit 8-2
 - USB rapid charge cable 1-6, 8-1, 8-3
 - vehicle charge cradle 1-6, 8-1, 8-6
- ActiveSync 2-9, 8-13
 - icon 2-7
 - installing 8-13
 - setting up a connection 8-14

- synchronization 8-14
- adaptive frequency hopping 7-1
- adaptive scanning 3-2
- adjusting audio volume 4-4
- adjusting volume 2-14
- Adobe Reader 2-10
- AFH 7-1
- AirBEAM 2-10
- alarms 2-10
- answering a call 4-7
- assisted GPS 6-3
- audio 4-4
- audio icon 2-4
- auto charge cable 8-1

B

- bar codes
 - one dimensional 3-1
- Battery 8-10
- battery 1-5
 - charging 1-6, 8-4
 - check status 1-8
 - installing 1-5
 - management 1-10
 - replacing 1-8
- battery charging
 - charging indicators 8-10
 - charging temperature 8-10
- battery charging 1-6
 - using single slot charge cradle 8-4
- battery cover 1-2
- battery door 8-2
- battery icon 2-4, 2-15
- battery status indications 2-15
- blank slot cover 8-2
- Bluetooth 7-1

- adaptive frequency hopping 7-1
- configuration 7-3
- discovering devices 7-5
- power states 7-3
- resume 7-3
- security 7-2
- suspend 7-3
- turning off 7-5
- turning on 7-4
- bluetooth
 - turning on and off 7-4
- Bluetooth headset 4-3
- bullets xv
- buttons
 - function 2-20
 - power 1-8, 2-20
 - scan 2-20
 - up and down 2-20

C

- cables
 - auto charge cable 8-1
 - DEX cable 8-1
 - USB rapid charge cable 1-6, 8-1, 8-3
- calculator 2-9
- calendar 2-8
- calibrating the screen 1-8
- call log 4-6, 4-13
- camera xii
 - scanning 3-3
- Charge 1-3
- charger 8-10
- charger cup 8-2
- chargers
 - four slot battery charger 8-1, 8-10
- charging 2-16
 - spare batteries 1-7
 - using single slot charge cradle 8-4
- charging indicators
 - four slot battery charger 8-10
- charging temperature 1-7, 8-5
 - four slot battery charger 8-10
- Classic Today Screen 2-6
- cleaning 9-1
- command bar
 - icons 2-5, 2-7
- conference call 4-17, 4-19
- configuration xii
- Configure 1-3
- connectivity icon 2-3
- Contacts 2-8
- contacts 2-8
- contacts application 4-5

- conventions
 - notational xv
- cradles
 - multi slot universal charge only cradle 1-6, 8-1, 8-5
 - multi slot universal charge only cradle with five MC45 cups installed 8-1
 - single slot charge cradle 1-6, 8-1, 8-4
 - vehicle 1-6, 8-1, 8-6

D

- data capture xii
 - adaptive scanning 3-2
 - camera scanning 3-3
 - linear scanning 3-1
 - one dimensional bar codes 3-1
 - scan angle 3-1
 - scan button 2-20
 - scan range 3-1
 - scanning 3-2
- DataWedge 3-4
 - disable 3-4
 - enable 3-4
 - icon 2-7
 - settings 2-12
- debug 2-10
- DEMO 2-10
- Device Lock 2-17
- DEX cable 8-1
- dialer
 - phone 4-1
- display xii
- display orientation 2-22

E

- e-mail 2-8
- emergency calls 2-17, 2-19, 4-7
- entering data 2-21
- ESD 1-3

F

- file explorer 2-9
- four slot battery charger 8-1, 8-10
 - charging indicators 8-10
 - charging temperature 8-10
- four slot battery charger cup adapter 8-2
- function buttons 2-20
- Fusion 5-1

G

- games 2-9

getting started 2-8
 global positioning system 6-1
 GPS 6-1
 GPS assist 2-11

H

handset mode 4-3
 handstrap 8-2
 headset 4-3
 headset mode 4-3
 help 2-10
 hexadecimal keys 5-5
 High-Speed Downlink Packet Access 4-1
 Home Screen 2-1
 Human Interface Device (HID) 7-14

I

icons
 ActiveSync 2-7
 audio 2-4
 bar 2-5
 battery 2-4, 2-15
 connectivity 2-3
 DataWedge 2-7
 notifications 2-2
 speaker 2-14
 status 2-2
 task tray 2-7
 WAN 2-3
 wireless connection status 2-7
 indicators 2-16
 radio status 2-16
 information, service xvi
 Install 1-2, 1-3
 Internet Explorer Mobile 2-8
 internet sharing 2-9, 7-9
 IrDA 2-11

K

key descriptions
 numeric keypad B-2
 keypads xii
 alphanumeric B-3
 backspace B-3
 blue key B-2
 end B-2
 Enter B-3
 input modes B-4
 key descriptions B-2
 numeric B-1
 orange key B-2

pound/space B-3
 scan B-2
 SHIFT B-3
 special character key B-4
 star / backlight key B-3
 talk B-2

L

laser scanning
 See data capture 3-1
 LEDs
 battery status 2-16
 charging 2-16, 8-10
 indicators 2-16
 scan and decode 3-2, 3-3
 left and right key B-2
 lithium-ion battery 1-2
 locking MC45 2-17
 password locking 2-18

M

maintenance 9-1
 marketplace 2-9
 masked characters 5-5
 MC4587 xii
 MC4597 xii
 Media Player 2-8
 memory xii
 memory card 1-3
 messaging 2-9
 Windows Live Messenger 2-9
 micro 8-11
 micro USB adapter 8-2, 8-11
 microSD 1-3
 installing 1-3
 mount bracket 8-2
 MSN Money 2-9
 MSN Weather 2-9
 MSP Agent 2-10
 multi slot universal charge only cradle 1-6, 8-1, 8-5
 multi slot universal charge only cradle with five MC45
 cups installed 8-1
 muting a call 4-9

N

navigation bar
 icons 2-2
 network activation 1-9
 GSM/UMTS 1-9
 notational conventions xv
 notes 2-9

notifications icon 2-2
 numeric keypad B-1
 input modes B-4
 key descriptions B-2

O

Object Push Services 7-8
 Office Mobile 2-9
 operating environment A-1
 operating system xii

P

pass-phrase 5-5
 passwords 2-18
 hint 2-19
 phone 2-9
 answering a call 4-7
 call log 4-6
 conference call 4-17, 4-19
 contacts 4-5
 dialer 4-1
 emergency calls 4-7
 making a call 4-5
 MMS messaging 4-22
 muting a call 4-9
 SMS messaging 4-20
 speed dial
 adding entry 4-10
 calling 4-7
 deleting entry 4-12
 editing entry 4-12
 three-way call 4-17, 4-19
 turning on and off 4-2
 using call log 4-13
 using keypad 4-5
 Voice Commander 4-24
 Phone Book Access profile 7-13
 pictures 2-8
 Power 1-3
 power button 1-8, 2-20
 power supply 8-1

R

radios xii
 rapid deployment 2-10
 recording video 2-23
 remote desktop 2-9
 replacing battery 1-8
 reset 2-17
 resetting the MC45 2-17
 resume 7-3

S

scan button 2-20
 scan/decode 2-16
 scanning
 button 2-20
 See data capture 3-1
 screen 1-8
 calibrate 1-8
 calibration 1-8
 screen protector 8-2, 9-2
 search phone 2-9
 security
 Bluetooth 7-2
 service information xvi
 settings 2-8, 2-11
 about 2-12
 backlight 2-12
 beam 2-11
 Bluetooth 2-11
 buttons 2-12
 certificates 2-12
 clock & alarms 2-11
 connections 2-11
 connections folder 2-11
 customer feedback 2-12
 DataWedge 2-12
 device information 2-12
 domain enroll 2-11
 encryption 2-12
 error reporting 2-12
 external GPS 2-13
 GPS assist 2-11
 Home 2-11
 input 2-12
 keylight 2-12
 KeyRemap 2-12
 lock 2-11
 managed programs 2-13
 memory 2-13
 owner information 2-12
 personal folder 2-11
 phone 2-12
 phone network setup 2-11
 power 2-11
 regional settings 2-13
 remove programs 2-13
 screen 2-13
 sounds & notifications 2-11
 system folder 2-11
 system info 2-13
 task manager 2-13
 USB connect 2-11
 Voice Commander settings 2-12

- wireless manager 2-12
 - WLAN 2-12
 - SIM card
 - accessories 1-4
 - installing 1-4
 - single slot charge cradle 1-6, 8-1, 8-4
 - charging 8-4
 - smart dialing 4-8
 - SMS Staging 2-10
 - soft holster 8-2
 - soft keys bar 2-8
 - spare battery 8-2
 - charging 1-7
 - speaker icon 2-14
 - speaker mode 4-3
 - special character key B-4
 - speed dial 4-7, 4-10
 - start screen 2-8
 - ActiveSync 2-9
 - AirBEAM 2-10
 - alarms 2-10
 - calculator 2-9
 - calendar 2-8
 - contacts 2-8
 - debug 2-10
 - DEMO 2-10
 - e-mail 2-8
 - file explorer 2-9
 - games 2-9
 - getting started 2-8
 - help 2-10
 - Internet Explorer Mobile 2-8
 - internet sharing 2-9
 - marketplace 2-9
 - Media Player 2-8
 - messaging 2-9
 - MSN Money 2-9
 - MSN Weather 2-9
 - MSP Agent 2-10
 - notes 2-9
 - Office Mobile 2-9
 - phone 2-9
 - pictures 2-8
 - rapid deployment 2-10
 - remote desktop 2-9
 - search phone 2-9
 - settings 2-8
 - SMS Staging 2-10
 - task manager 2-9
 - tasks 2-9
 - text 2-8
 - today 2-8
 - toolbox 2-10
 - videos 2-8
 - Windows Live 2-9
 - wireless companion 2-9
 - starting the MC45 1-8
 - status icon 2-2
 - audio 2-4
 - battery 2-4, 2-15
 - connectivity 2-3
 - notifications 2-2
 - speaker 2-14
 - WAN 2-3
 - Streaming Player 2-10
 - Stylus 2-21
 - stylus 1-2, 2-21
 - stylus with tether kit 8-2
 - subscriber identification module 1-4
 - suspend 2-20, 7-3
 - synchronize with PC
 - using Bluetooth 7-11
- ## T
- taking photos 2-23
 - task manager 2-9, 2-13
 - task tray icons 2-7
 - tasks 2-9
 - technical specifications A-1
 - accessories A-4
 - temperature A-2
 - charging 1-7, 8-5, 8-10
 - text 2-8
 - three-way call 4-17, 4-19
 - Time To First Fix 6-3
 - today 2-8
 - Today Screen 2-5
 - toolbox 2-10
 - Adobe Reader 2-10
 - Streaming Player 2-10
 - Voice Commander 2-10
 - troubleshooting 9-5
- ## U
- unpacking 1-2
 - up and down button 2-20
 - up and down key B-2
 - USB 8-3
 - USB rapid charge cable 8-1, 8-3
 - charging 1-6
 - using Bluetooth headset 4-3
 - using stylus 2-21
- ## V
- vehicle charge cradle 1-6, 8-1, 8-6

videos 2-8
viewing photos and videos 2-23
Voice Commander 2-10, 4-24
 settings 2-12
volume 4-4

W

wakeup conditions 2-17
waking the MC45 2-17
WAN icon 2-3
Windows Live 2-9
Windows Live Messenger 2-9
Wireless 1-10, 4-2
wireless companion 2-9
wireless connection status
 icon 2-7
Wireless Manager 1-10, 4-2
wireless manager 2-12
Wireless Zero Config 5-2
WLAN 2-12
 802.11a/b/g xii
WWAN
 GSM/HSDPA xii



Zebra Technologies Corporation
Lincolnshire, IL U.S.A
<http://www.zebra.com>

Zebra and the Zebra head graphic are registered trademarks of ZIH Corp. The Symbol logo is a registered trademark of Symbol Technologies, Inc., a Zebra Technologies company.
© 2015 Symbol Technologies, Inc.