

# MC45

## Quick Start Guide

### FEATURES

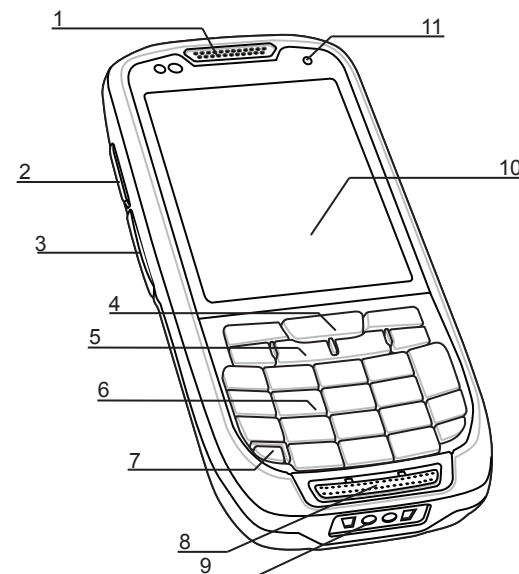
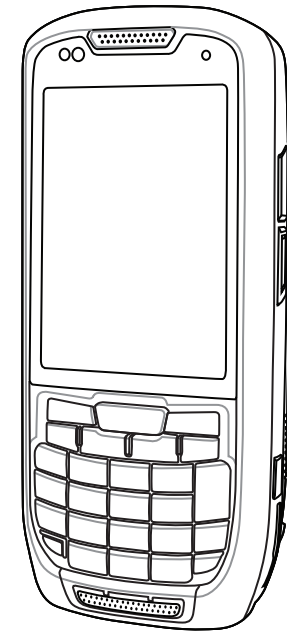

- 1 Receiver
- 2 Programmable Button (Scan)
- 3 MicroUSB Port
- 4 Scan Button
- 5 Up/Down Button
- 6 Keypad
- 7 Power Button
- 8 Microphone
- 9 Charging Connector (with screen protector)
- 10 Touch Screen
- 11 Charging/Battery Status LED

- 12 Battery Cover
- 13 Handstrap Mount
- 14 Scan Window (see Data Capture Options)
- 15 Tether Point
- 16 3.2 MPixel Camera
- 17 Camera Flash
- 18 Volume Buttons
- 19 Programmable Button (Camera)
- 20 Stylus
- 21 Battery Cover Latch

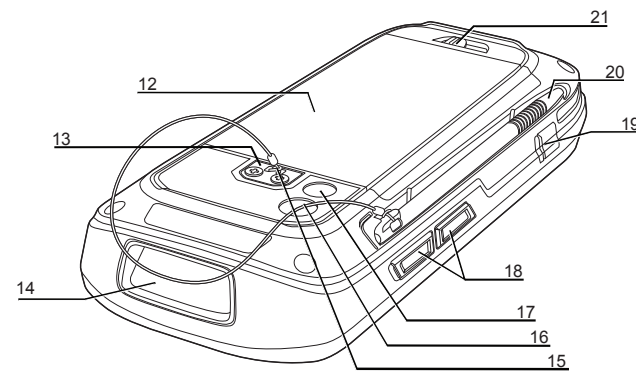

### KEYPAD

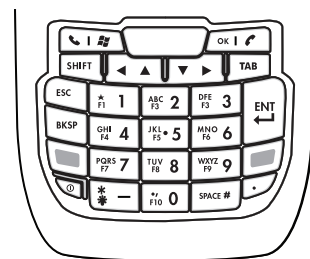

Numeric Keypad

#### Blue Key

- Use this key to access function keys shown on the keypad in blue.
- > Press the blue key once to activate this mode followed by another key.
- > Press the blue key twice to lock the keypad in the blue keys mode.
- > Press the blue key again to return to the normal mode.

#### Orange Key

- Use this key to access the secondary layer of characters and actions.
- > Press the orange key once to activate this mode followed by another key.
- > Press the orange key twice to lock the keypad in the orange keys mode .
- > Press the orange key again to return to the normal mode.

Note: See the MC45 User Guide for detailed keypad information.

### GETTING STARTED

#### 1 MicroSD and SIM Card Installation

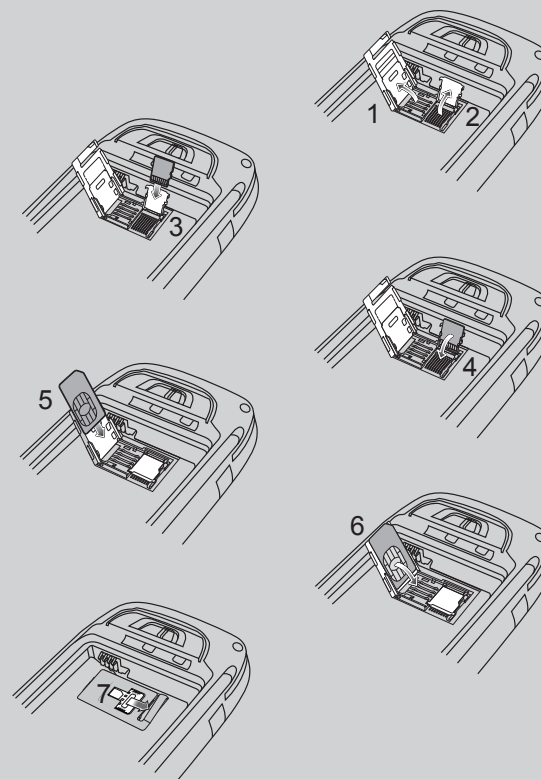

#### 2 Insert the Battery

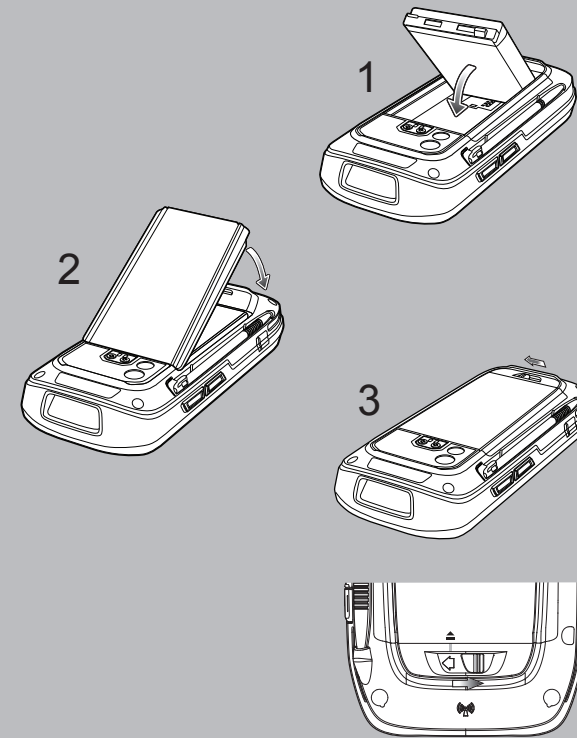

Note: To lock the battery cover, slide the battery cover latch to the right until the red dot is not visible.

#### 3 Charge the MC45

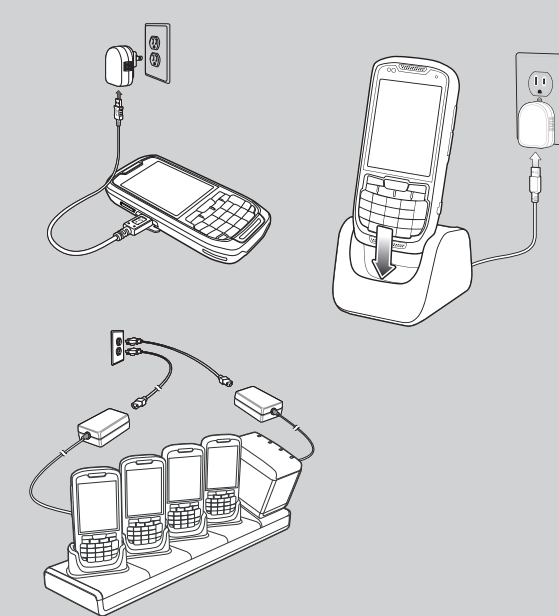

- **Charging/Battery Status LED**
- Slow Blinking Green = Charging
- Solid Green = Fully Charged
- Fast Blinking Red = Charging Error

\* It is recommended that this product be charged for 24 hours before the first use to ensure that the internal battery is fully charged.

# ACCESSORIES

# DATA CAPTURE OPTIONS

# AVOID EXTREME WRIST ANGLES

## 4 Install ActiveSync®

Download ActiveSync®4.5 or higher from <http://www.microsoft.com> and follow the instructions to install ActiveSync onto the host computer.

## 5 Communicate with Host

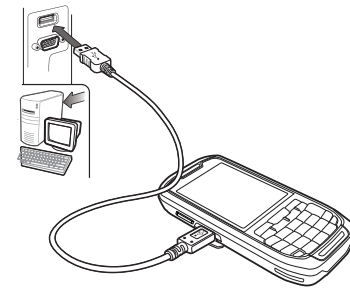

## 6 Create a Partnership

Follow the on-screen ActiveSync®4.5 instructions to establish a connection between the MC45 and the host computer.

## Battery Removal

Turn off the MC45 before removing the battery. If the MC45 is in suspend mode, press the red Power button to wake the MC45. Press the red Power button for 3 seconds until a screen appears. Select the Power Off option to turn off the MC45.

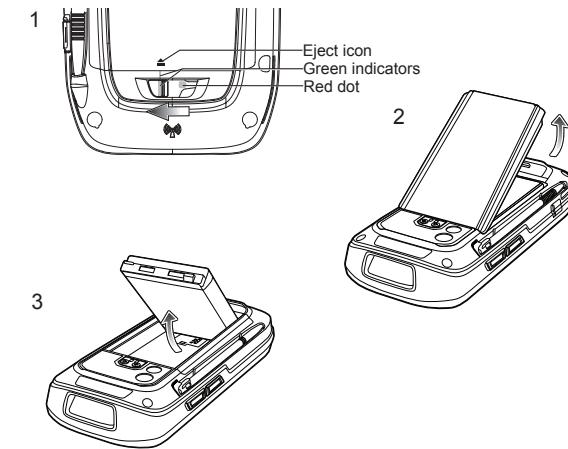

Note: To unlock and remove the battery cover, slide the battery cover latch to the left until the green indicators align with the eject icon and the red dot is visible. The battery cover ejects slightly. Lift to remove.

## Screen Protector

Zebra recommends the use of a screen protector to minimize wear and tear. Screen protectors enhance the usability and durability of touch screen displays. Benefits include:

- Protection from scratches and gouges
- Durable writing and touch surface with tactile feel
- Abrasion and chemical resistance
- Glare reduction
- Keeping the device's screen looking like new
- Quick and easy installation.

Not using a screen protector can affect your warranty coverage. An initial screen protector is already applied to your MC45. Contact your local account manager or Zebra, Inc. for more information and purchasing details.

## Vehicle Charge Cradle

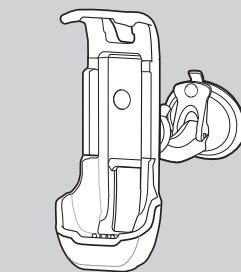

## Power Supply

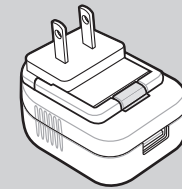

## Single Slot Charge Cradle

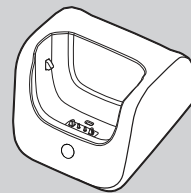

## Four Slot Battery Charger

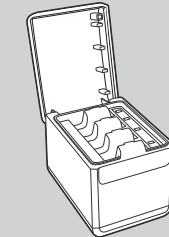

## Auto Charge Cable

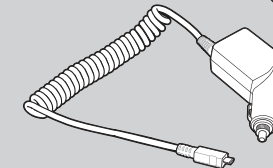

## Multi Slot Universal Charge Only Cradle

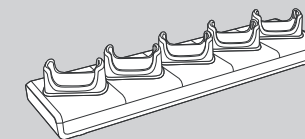

## micro USB Adapter

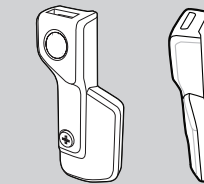

## Laser Scanning

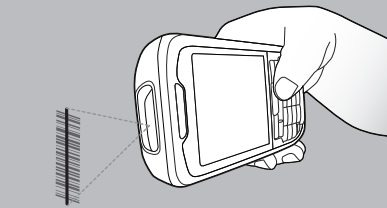
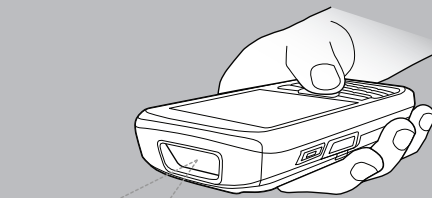

## Camera Decode

1. Launch a barcode reading application on the MC45.
2. Point the MC45 towards the barcode.
3. Press the Scan button.
4. In the image window, align the camera over the barcode. When the MC45 decodes the barcode, a beep sounds.
5. Release the Scan button.

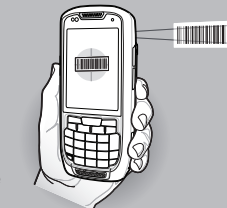

## Camera Photo

1. Tap Start > Pictures & Videos.
2. Point the MC45 at an object.
3. Press the Camera button.
4. Hold the MC45 still until the "Shutter Sound" is heard.

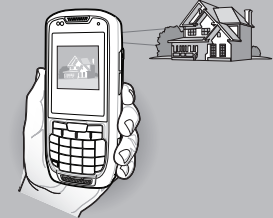

## GPS Information

- When using the GPS feature of the MC45:
- Acquiring satellite signals may take a few minutes. It is best to be outside and have a clear, unobstructed view of the sky.
  - Without a clear view, acquisition takes much longer and could result in the MC45 being unable to compute the initial position quickly.
  - Obtain a satellite fix before moving.
  - Shutdown GPS application when not in use to extend battery life.

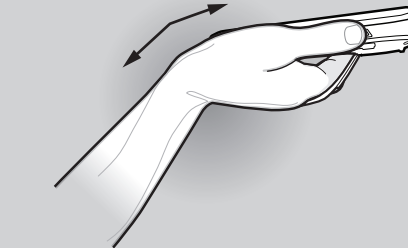

AVOID EXTREME WRIST ANGLES

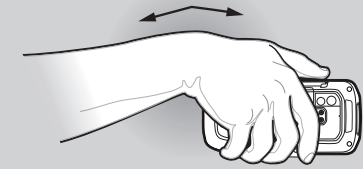

Zebra Technologies Corporation  
Lincolnshire, IL U.S.A  
<http://www.zebra.com>

Zebra and the Zebra head graphic are registered trademarks of ZIH Corp. The Symbol logo is a registered trademark of Symbol Technologies, Inc., a Zebra Technologies company. © 2015 Symbol Technologies, Inc.



72-164157-02 Rev A – February 2015