

MC9500-K QUICK START GUIDE

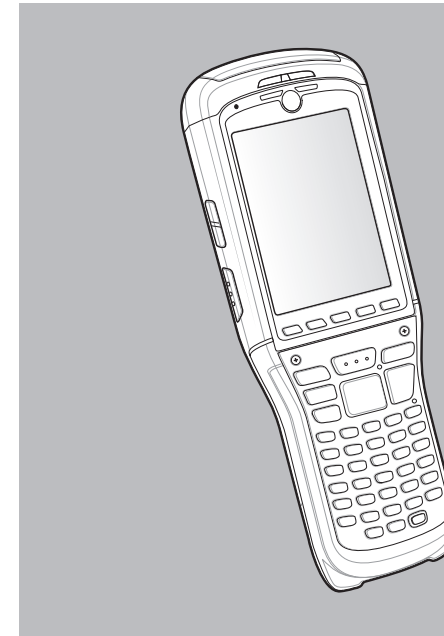

FEATURES

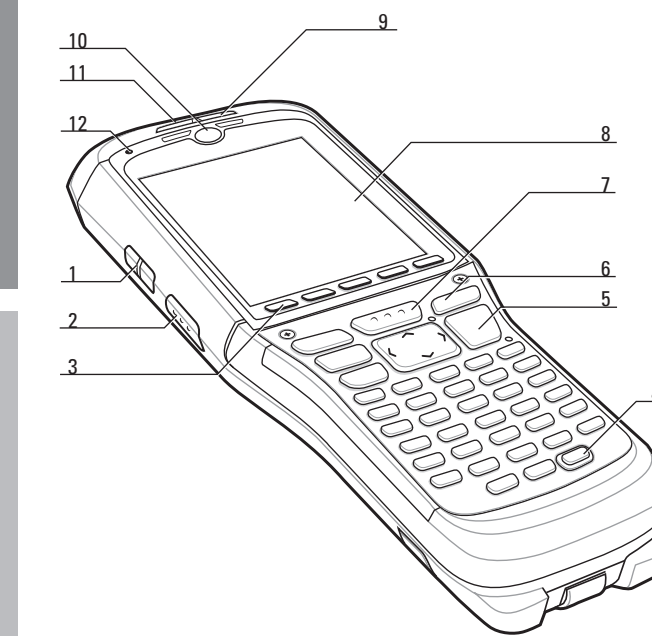

- 1 Up/Down Volume Button
- 2 Scan Button
- 3 Function Keys
- 4 Power Button
- 5 Keypad
- 6 Microphone
- 7 Scan Button (with screen protector)
- 8 Touch Screen
- 9 Decode LED
- 10 Receiver
- 11 Battery Status LED
- 12 WAN Radio Status LED

Note 1: To warm boot the MC9500-K, press and hold the Power button for five(5) seconds.
To cold boot the MC9500-K, press and hold the 1, 9 and Power button.

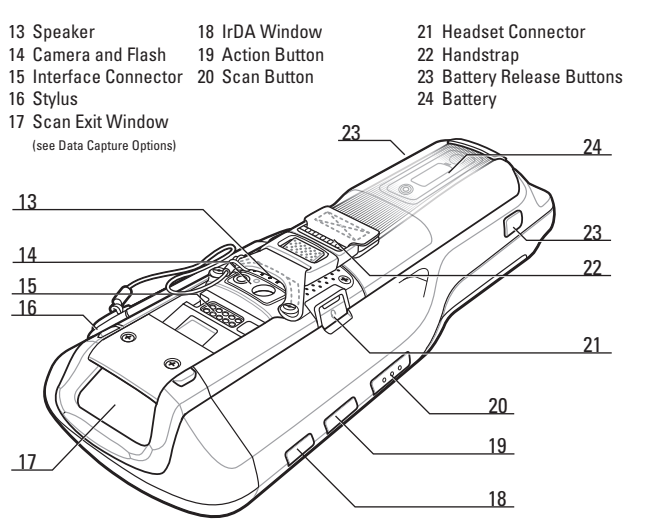

- 13 Speaker
- 14 Camera and Flash
- 15 Interface Connector
- 16 Stylus
- 17 Scan Exit Window (see Data Capture Options)
- 18 IrDA Window
- 19 Action Button
- 20 Scan Button
- 21 Headset Connector
- 22 Handstrap
- 23 Battery Release Buttons
- 24 Battery

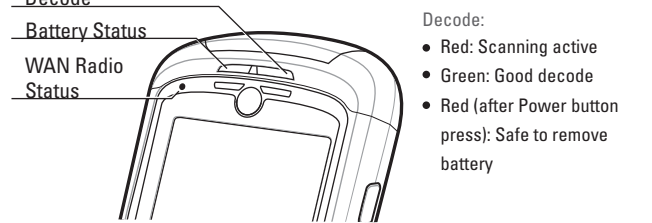

KEYPADS



Telephony Numeric



Calculator Numeric

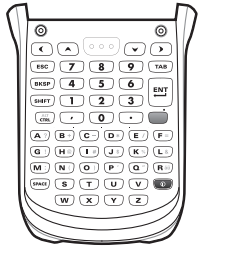

Alpha Numeric

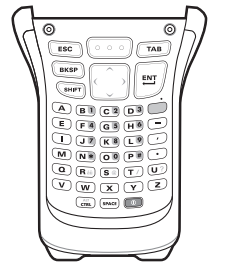

Alpha Primary

GETTING STARTED

1 SIM Card Installation (GSM Only)

- Press the Power button to suspend the device.
- On the **PowerKey Action** screen, tap **Safe Battery Swap**.
- Wait for red Decode LED to turn on and then turn off.
- Unhook handstrap.
- Press battery release buttons and remove battery.
- Remove SIM cover using the top end of the stylus.
- Slide SIM card holder to the left.
- Lift card holder.
- Insert SIM card into SIM holder.

NOTE: The proper position of the SIM card—the card connector (i.e., gold area) should be facing down with the beveled edge facing up.

- Lower the SIM card holder down.
- Slide SIM card holder to the right to lock into place.
- Reinstall SIM cover.
- Reinstall battery.
- Connect handstrap.
- Warm boot the device.

NOTE: For detailed information on SIM card installation, refer to the *MC9500 Integrator Guide*.

2 microSD Card Installation

- Press the Power button to suspend the MC9500-K.
- On the **PowerKey Action** screen, tap **Safe Battery Swap**.
- Wait for red Decode LED to turn on and then turn off.
- Unhook the handstrap.
- Press the battery release buttons and remove the battery.
- Remove the SD card cover using the top end of the stylus.
- Slide the microSD card door to the left to unlock.
- Lift the door.
- Place the microSD card onto the contacts.

NOTE: The proper position of the microSD card—the card connector (i.e., gold area) should be facing down as shown.

- Lower the microSD card door.
- Slide door to the right to lock into place.
- Reinstall the SD card cover.
- Reinstall the battery.
- Reconnect the handstrap.
- Warm boot the MC9500-K.

3 Insert the Battery

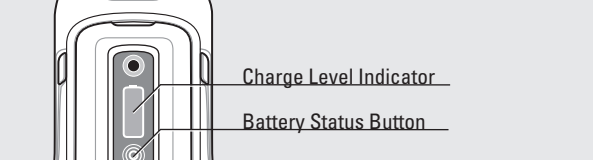
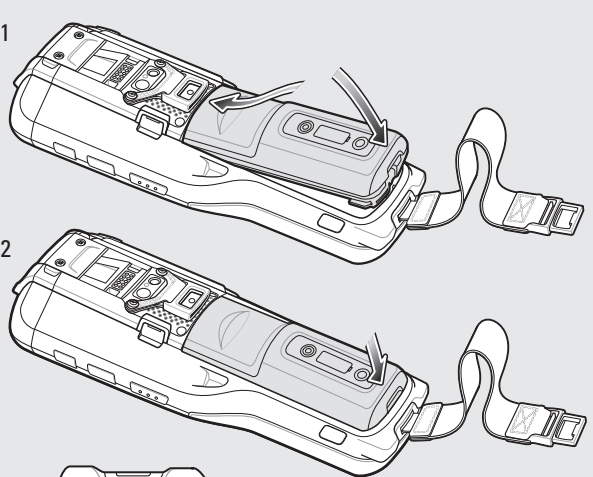

- Battery Indications**
- Press the Battery Status button. Charge Level Indicator displays approximate battery level.
- Fully Charged
 - Partially Charged
 - Unhealthy

4 Charge the MC9500-K

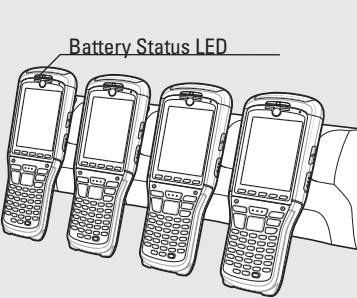
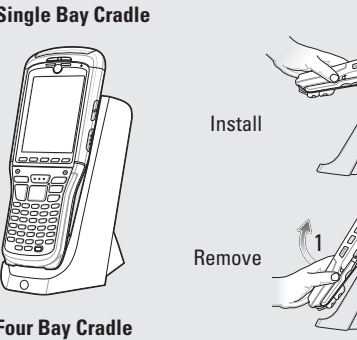

MC9500-K Battery Status LED

- Slow Blinking Amber = Healthy battery charging
- Slow Blinking Red = Unhealthy battery charging
- Solid Green = Healthy battery fully charged
- Solid Red = Unhealthy battery fully charged
- Fast Blinking Amber = Charging error

It is recommended that this product be charged for 24 hours before the first use to ensure that the internal battery is fully charged.

5 Charge the Battery

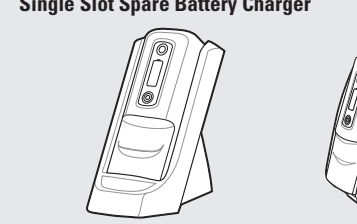

Battery Status LED (in charger)

- Slow Blinking Amber = Healthy battery charging
- Slow Blinking Red = Unhealthy battery charging
- Solid Green = Healthy battery fully charged
- Solid Red = Unhealthy battery fully charged
- Fast blinking Amber = Charging error

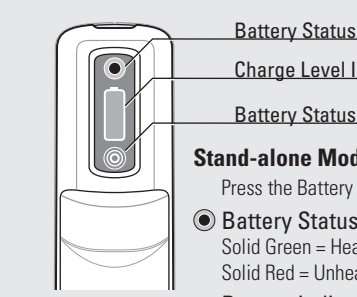
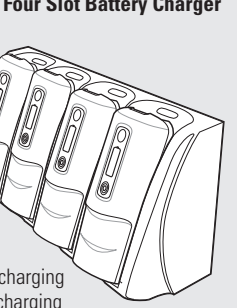

Stand-alone Mode

Press the Battery Status button.

Battery Status LED

- Solid Green = Healthy battery
- Solid Red = Unhealthy battery

Battery Indications

Charge Level Indicator displays approximate battery level.

- Fully Charged
- Partially Charged
- Unhealthy

BATTERY REMOVAL

1. Press Power button to suspend the MC9500-K.
2. Wait for the red Decode LED to turn on and then turn off.
3. Unhook handstrap.
4. Press the two battery release latches. The battery ejects slightly from the device.
5. Remove battery from device.

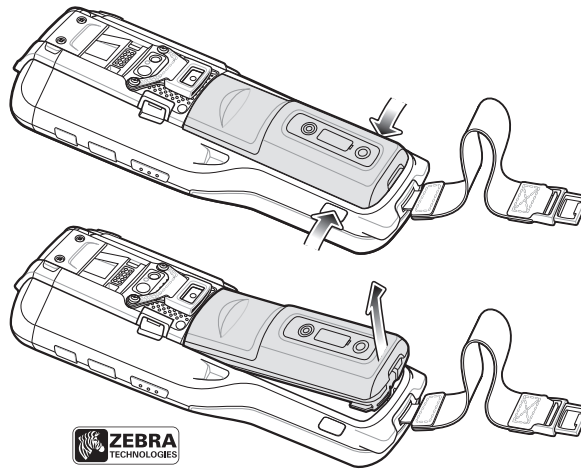

Zebra Technologies Corporation
Lincolnshire, IL U.S.A.

Zebra and the Zebra head graphic are registered trademarks of ZIH Corp. The Symbol logo is a registered trademark of Symbol Technologies, Inc., a Zebra Technologies company.
© 2015 Symbol Technologies, Inc.



72-118504-06 Rev. A—February 2015

COMMUNICATION

1 Install ActiveSync®

Download ActiveSync® 4.5 or higher from <http://www.microsoft.com> and follow the instructions to install ActiveSync onto the host computer.

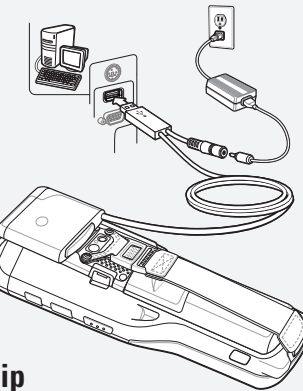

2 Communicate with Host

Follow the on-screen ActiveSync instructions to establish a connection between the MC9500-K and the host computer.

3 Create a Partnership

4 Enter Your PIN

After installing the SIM card activate your mobile service connection. In most cases, SIM cards are preset with a PIN (Personal Identity Number), provided by your service provider.

1. Press the Power button to turn on the MC9596-K.
2. Tap **Start > Phone**.
3. Enter the PIN from your service provider.
4. Tap Enter.

For more information visit:
<http://www.zebra.com/mc9500>

ACCESSORIES

Screen Protector

Zebra recommends the use of a screen protector to minimize wear and tear. Screen protectors enhance the usability and durability of touch screen displays. Benefits include:

- Protection from scratches and gouges with tactile feel
- Durable writing and touch surface
- Abrasion and chemical resistance
- Glare reduction
- Keeping the device's screen looking like new
- Quick and easy installation.

Not using a screen protector can affect your warranty coverage.

An initial screen protector is already applied to your MC9500-K. Contact your local account manager or Zebra for more information and purchasing details. Part number: KT-122010-01R Screen Protector 3/pk.

Vehicle Cradle

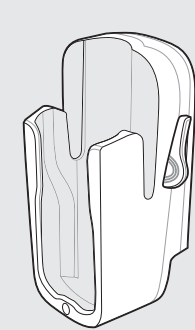

Auto-Charge Cable

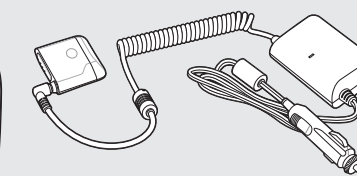

Vehicle Battery Charger

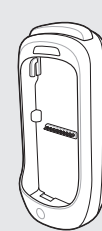

Single Bay USB Cradle

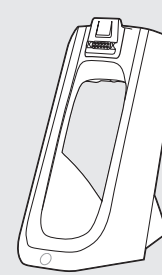

Single Slot Battery Charger

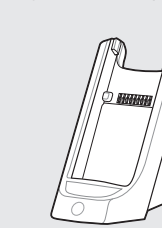

USB/Charging Cable

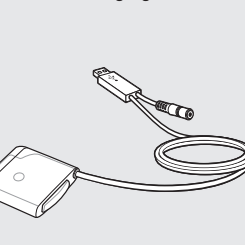

Four Bay Ethernet Cradle

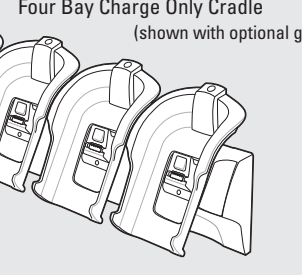

Four Slot Battery Charger

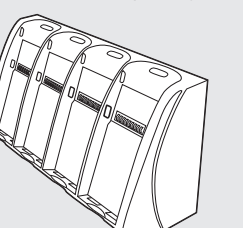

Magnetic Stripe Reader

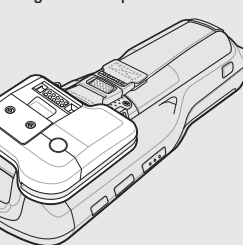

CABLE CONNECTION

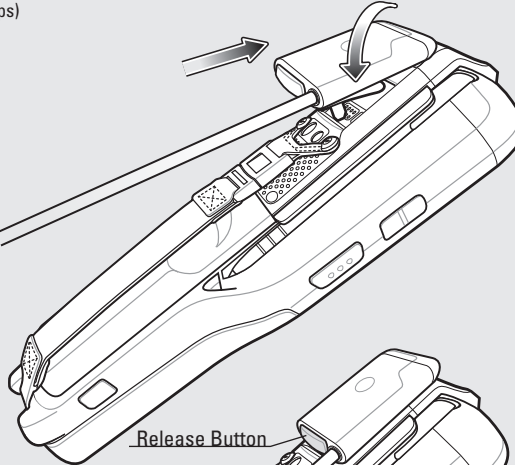

DATA CAPTURE OPTIONS

Camera Lens

Exit Window

Laser scanner or Imager

GPS Information

When using the GPS feature of the MC9500-K:

- Acquiring satellite signals may take a few minutes. It is best to be outside and have a clear, unobstructed view of the sky.
- Obtain a satellite fix before moving.
- Shutdown GPS application when not in use.

DATA CAPTURE OPTIONS

Scanning/Imaging

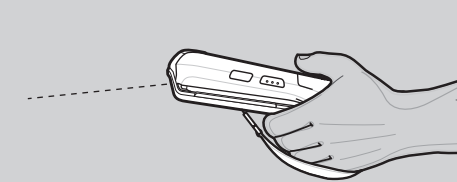

Laser Scanning



Imaging

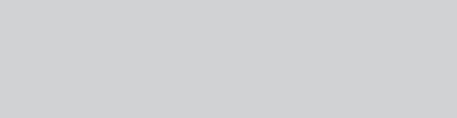

OPTIMUM SCANNING AND IMAGING

Camera Decode

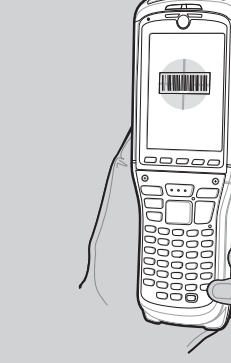

Barcode



1. Launch a bar code reading application on the MC9500-K.
2. Position the MC9500-K toward the bar code.
3. Press the **Scan** button.
4. In the image window align the red target over the bar code. When the MC9500-K decodes the bar code the target turns green.
5. Release the Scan button.

Camera Photo

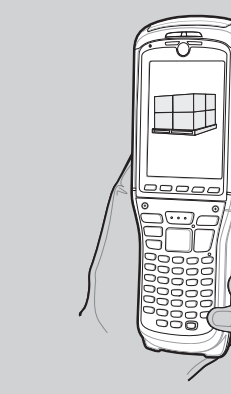

Barcode

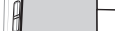

1. Tap **Start > Programs > Pictures & Videos > Camera**.
2. Point the MC9500-K at an object.
3. Press the **Enter** button.
4. Hold MC9500-K still until "Shutter Sound" is heard.

ERGONOMIC CONSIDERATIONS

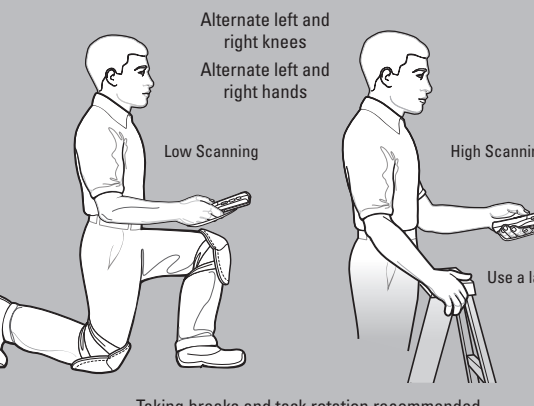
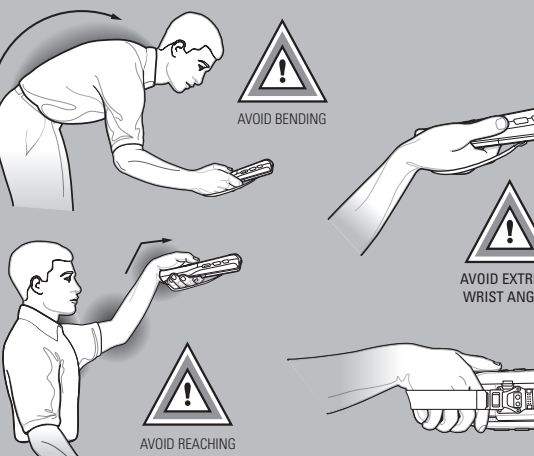

Taking breaks and task rotation recommended