

# MT2070/MT2090

## User Guide





**MT2070/MT2090**  
**User Guide**

72E-117859-08

Revision A

March 2015

© 2015 Symbol Technologies, Inc.

No part of this publication may be reproduced or used in any form, or by any electrical or mechanical means, without permission in writing from Zebra. This includes electronic or mechanical means, such as photocopying, recording, or information storage and retrieval systems. The material in this manual is subject to change without notice.

The software is provided strictly on an “as is” basis. All software, including firmware, furnished to the user is on a licensed basis. Zebra grants to the user a non-transferable and non-exclusive license to use each software or firmware program delivered hereunder (licensed program). Except as noted below, such license may not be assigned, sublicensed, or otherwise transferred by the user without prior written consent of Zebra. No right to copy a licensed program in whole or in part is granted, except as permitted under copyright law. The user shall not modify, merge, or incorporate any form or portion of a licensed program with other program material, create a derivative work from a licensed program, or use a licensed program in a network without written permission from Zebra. The user agrees to maintain Zebra’s copyright notice on the licensed programs delivered hereunder, and to include the same on any authorized copies it makes, in whole or in part. The user agrees not to decompile, disassemble, decode, or reverse engineer any licensed program delivered to the user or any portion thereof.

Zebra reserves the right to make changes to any software or product to improve reliability, function, or design.

Zebra does not assume any product liability arising out of, or in connection with, the application or use of any product, circuit, or application described herein.

No license is granted, either expressly or by implication, estoppel, or otherwise under any Zebra Technologies Corporation, intellectual property rights. An implied license only exists for equipment, circuits, and subsystems contained in Zebra products.

Zebra and the Zebra head graphic are registered trademarks of ZIH Corp. The Symbol logo is a registered trademark of Symbol Technologies, Inc., a Zebra Technologies company.

Zebra Technologies Corporatio  
nLincolnshire, IL U.S.A.  
<http://www.zebra.com>

---

## Warranty

The MT2000 Series is warranted against defects in workmanship and materials for a period of 36 months from date of shipment, provided that the product remains unmodified and is operated under normal and proper conditions

For the complete Zebra hardware product warranty statement, go to:  
<http://www.zebra.com/warranty>.



## Revision History

Changes to the original manual are listed below:

Change	Date	Description
-01 Rev A	8/2009	Initial release.
-02 Rev A	9/2009	Updates: Keypad; battery information; accessories.
-03 Rev A	10/2011	Updates: USB cable usage with ActiveSync; USB French Belgian Windows bar code fix; device charging LED update; new screen shots Additions: Scan-to-IP; ESD dongle information; FIPS; Inverse 1D; Multi-tap Uppercase First Feature; Code Types: Aztec, Datamatrix, Maxicode, QR code, MicroPDF. Removed: Patent information.
-04 Rev A	2/2013	Updates: - Static CDC is enabled by default. Additions: - USB Transmission Speed Parameters (Polling Interval, Fast HID Keyboard, Quick Keypad Emulation) - with note about re-enumerating the scanner. - GS1 Databar Limited Security level bar codes. - Enable/Disable USB HID over STB2000 contact. - DPM scanning - New DPM graphic to <i>Scanning Orientation with Imager Aiming Pattern</i> .
-05 Rev A	2/2014	Updates: - French Belgian Windows bar code Additions: - Codabar Upper or Lower Case Start/Stop Characters Detection bar codes - ADF bar codes: ... Move Cursor Past Specific String ... Move Cursor To Specific String and Replace ... Move Cursor To Last Occurrence of String and Replace All ... Skip To End Australia Post Format bar code Composite Beep Mode bar code ISBT Concatenation Redundancy bar code USB Ignore Beep Directive bar code USB Ignore Type Directive bar code

Change	Date	Description
-06 Rev A	6/2014	Additions: Scan Angle Adaptive Scanning Interference Suppression Mode Interference Suppression Scan Angle Update: Device Configurations
-07 Rev A	8/2014	Additions: Matrix 2 of 5 Matrix 2 of 5 Set Lengths Matrix 2 of 5 Check Digit Transmit Matrix 2 of 5 Check Digit Parameter Pass Through Update: Adaptive Scanning default Remove: ISBT Concatenation Redundancy bar code
-08 Rev	3/2015	Zebra Re-Branding

# Table of Contents

Warranty .....	iv
Revision History .....	v

## About This Guide

Introduction .....	xix
Documentation Set .....	xix
Device Configurations .....	xx
Cradle Configurations .....	xx
Chapter Descriptions .....	xxi
Notational Conventions .....	xxii
Related Documents .....	xxiii
Service Information .....	xxiii

## Chapter 1: Getting Started

Introduction .....	1-1
Unpacking .....	1-1
MT20X0 .....	1-1
Cradles .....	1-1
STB2000-C10007R Single Slot Charge Only with ActiveSync .....	1-1
STB2000-F10007R Forklift Single Slot Charge Only .....	1-2
STB2078-C10007WR Single Slot Multi-interface Bluetooth .....	1-2
STB2000-C40007R Four Slot Charge Only .....	1-2
STB2000-C40017R Four Slot Ethernet .....	1-2
SAC2000-4000CR Four Slot Spare Battery Charger .....	1-2
Accessories .....	1-2
Features .....	1-3
Cradle Features .....	1-4
Single Slot - Front View and Connections .....	1-4
Single Slot - Back View .....	1-5
Single Slot - Mounting Cups .....	1-6
Four Slot - Front View and Connections .....	1-7
Four Slot - Back View .....	1-8
Four Slot Spare Battery Charger .....	1-9

Host Interfaces .....	1-10
Out-of-Box Startup .....	1-10
Insert the Battery .....	1-11
Connect the Cradle .....	1-11
Connecting the STB20XX Cradle .....	1-11
Connecting STB2000-F Cradle .....	1-12
Changing the Host Interface .....	1-12
Supplying Power to the Cradle .....	1-12
Using the USB Interface to Supply Power .....	1-12
Insert the Device in the Cradle .....	1-13
Removing the Device from a Vertical Mount Cradle (Forklift or Wall Mount) .....	1-13
Charge the Device Battery in the Cradle .....	1-13
Charging Indicator/LED .....	1-13
Configure the Device .....	1-13
Battery Charging .....	1-14
Battery Safety .....	1-15
Security Implementation/Protection From Counterfeit Batteries .....	1-15
Zebra Battery Safety Recommendations For Users .....	1-15
Proper and Safe Battery Disposal & Recycling .....	1-15
Sending Data to the Host Computer .....	1-16
Cable Mode .....	1-16
Bluetooth Mode .....	1-16
Pairing .....	1-16
Lost Connection to Host .....	1-16
Radio Communications .....	1-16
Startup .....	1-17
Suspending/Powering Off the Device .....	1-17
Resetting the Device .....	1-17
Turning the WLAN Radio On and Off .....	1-17
Waking the Device .....	1-17
Battery Removal .....	1-18
Spare Battery Charging .....	1-18
Screen Protector .....	1-18
Lanyard .....	1-19

## Chapter 2: Operating the MT2070/MT2090

Introduction .....	2-1
Keypad .....	2-2
Keypad Functionality .....	2-3
Keypad Multi-tap Configuration .....	2-7
Using the Keypad to Navigate Applications .....	2-8
Entering Information .....	2-8
Entering Information Using the Keypad .....	2-8
Screen Icons .....	2-9
Home Screen .....	2-11
Menu .....	2-12
User Settings .....	2-13
Device Status .....	2-15
Battery Status .....	2-15

About .....	2-16
Suspend .....	2-16
Scan Item .....	2-17
Quantity .....	2-17
Item .....	2-17
Menu .....	2-18
Options .....	2-18
About... ..	2-19
Close .....	2-19
Close .....	2-19
Scan Inventory .....	2-20
Location .....	2-20
Quantity .....	2-21
Item .....	2-21
Menu .....	2-21
View Inventory .....	2-21
View Inventory Menu .....	2-22
Save Inventory .....	2-24
Options... ..	2-25
About... ..	2-25
Close .....	2-25
Simple Inventory .....	2-26
Item .....	2-26
Quantity .....	2-26
Menu .....	2-27
Transmit .....	2-27
View Inventory .....	2-27
View Inventory Menu .....	2-28
Save Inventory .....	2-30
Options... ..	2-30
About... ..	2-31
Close .....	2-31
Scan-To-IP .....	2-32
Suspend .....	2-34
MCL .....	2-35
Scan Transmit .....	2-36
Scan Inventory .....	2-37
View Data .....	2-38
Send Data .....	2-38
Delete Last .....	2-38
Image Viewer (Devices Equipped with Imagers) .....	2-39
Menu .....	2-39
Preview On .....	2-39
Open .....	2-39
Options .....	2-40
About .....	2-40
Close .....	2-40
Config .....	2-41
Wireless Companion (MT2090 Only) .....	2-41
Find WLANs .....	2-42

Manage Profiles .....	2-42
Changing Profiles .....	2-43
Creating a New Profile .....	2-43
Profile ID .....	2-44
Profile Name .....	2-44
ESSID .....	2-44
Operating Mode .....	2-44
Operating Mode .....	2-45
Channel .....	2-46
Security Mode .....	2-47
Security Mode .....	2-48
Authentication Type .....	2-49
Tunneled Authentication .....	2-49
User Certificate Selection .....	2-51
User Certificate Installation .....	2-52
Server Certificate Selection .....	2-54
Server Certificate Installation .....	2-54
User Name .....	2-55
Password .....	2-56
Advanced Identity .....	2-57
Credential Cache Options .....	2-58
Encryption .....	2-60
Hexadecimal Keys .....	2-62
Pass-phrase Dialog .....	2-63
IP Address Entry .....	2-65
Transmit Power .....	2-67
Battery Usage .....	2-68
Deleting a Profile .....	2-69
Ordering Profiles .....	2-69
Exporting a Profile .....	2-69
Manage Certificates .....	2-69
Certificate Properties .....	2-71
Import a Certificate .....	2-71
Delete a Certificate .....	2-72
Manage PACs .....	2-73
PAC Properties .....	2-74
Delete PAC .....	2-74
Import PAC .....	2-74
Options .....	2-76
Operating Mode Filtering .....	2-76
Regulatory Options .....	2-77
Band Selection .....	2-77
System Options .....	2-78
Auto PAC Settings .....	2-78
Change Password .....	2-79
Export .....	2-81
Wireless Status .....	2-82
Signal Strength .....	2-83
Current Profile .....	2-83
IPv4 Status .....	2-85

Wireless Log .....	2-86
Versions .....	2-87
Wireless Diagnostics .....	2-87
ICMP Ping .....	2-88
Graphs .....	2-89
Trace Route .....	2-89
Known APs .....	2-90
Log On/Off .....	2-91
User Already Logged In .....	2-91
No User Logged In .....	2-91
Enable/Disable Radio .....	2-92
Settings .....	2-93
General Parameters .....	2-93
Bar Code Settings .....	2-93
Rapid Deployment .....	2-94
MSP Agent .....	2-94
BTE Explorer .....	2-95
Establish a New Connection .....	2-95
Add a Bluetooth Service .....	2-97
Turn Bluetooth On/Off .....	2-99
Miscellaneous Bluetooth Settings .....	2-99
Device Info Tab .....	2-99
Services Tab .....	2-99
Security Tab .....	2-100
Discovery Tab .....	2-100
Virtual COM Port Tab .....	2-101
Profiles Tab .....	2-101
Configure USB .....	2-102
Up .....	2-103
Menu .....	2-103
Utilities .....	2-104
File Explorer .....	2-104
File Explorer Functionality .....	2-104
File Explorer Keypad Usage .....	2-105
Task Manager .....	2-105
Resetting the MT20X0 .....	2-106
Performing a Warm Boot .....	2-106
Performing a Cold Boot .....	2-106
Waking the MT20X0 .....	2-107
File System Directory Structure .....	2-107

### Chapter 3: Scanning

Introduction .....	3-1
Beeper Definitions .....	3-1
LED Definitions .....	3-3
Scanning in Hand-Held Mode .....	3-4
Scanning with the MT20X0 .....	3-4
Aiming .....	3-4
Imager Aiming .....	3-4

Laser Aiming .....	3-6
Scanning in Presentation Mode .....	3-7
Scanning Considerations .....	3-8
Decode Distances .....	3-9

**Chapter 4: Radio Communications**

Introduction .....	4-1
Scanning Sequence Examples .....	4-1
Errors While Scanning .....	4-1
Radio Communications Parameter Defaults .....	4-2
Wireless Beeper Definitions .....	4-3
Radio Communications Host Types .....	4-4
Bluetooth Technology Profile Support .....	4-6
Master/Slave Set Up .....	4-6
Master .....	4-6
Slave .....	4-6
Bluetooth Friendly Name .....	4-7
Discoverable Mode .....	4-7
HID Host Parameters .....	4-8
HID Country Keyboard Types (Country Codes) .....	4-8
HID Keyboard Keystroke Delay .....	4-10
HID CAPS Lock Override .....	4-10
HID Ignore Unknown Characters .....	4-11
Emulate Keypad .....	4-11
HID Keyboard FN1 Substitution .....	4-12
HID Function Key Mapping .....	4-12
Simulated Caps Lock .....	4-13
Convert Case .....	4-13
Auto-reconnect Feature .....	4-14
Reconnect Attempt Beep Feedback .....	4-14
Reconnect Attempt Interval .....	4-15
Auto-reconnect in Bluetooth Keyboard Emulation (HID Slave) Mode .....	4-17
Out of Range Indicator .....	4-18
MT20X0(s) To Cradle Support .....	4-19
Modes of Operation .....	4-19
Point-to-Point Communication .....	4-19
Multipoint-to-Point Communication .....	4-19
Parameter Broadcast (Cradle Host Only) .....	4-19
Pairing .....	4-20
Pairing Modes .....	4-21
Lock Override .....	4-21
Pairing Methods .....	4-22
Unpairing .....	4-22
Pairing Bar Code Format .....	4-23
Pairing Bar Code Example .....	4-23
Connection Maintenance Interval .....	4-23
Considerations .....	4-24
Bluetooth Security .....	4-26
Authentication .....	4-26



PIN Code .....	4-27
Variable PIN Code .....	4-27
Encryption .....	4-28

## Chapter 5: User Preferences & Miscellaneous Scanner Options

Introduction .....	5-1
Scanning Sequence Examples .....	5-2
Errors While Scanning .....	5-2
User Preferences/Miscellaneous Options Parameter Defaults .....	5-2
User Preferences .....	5-4
Set Default Parameter .....	5-4
Host Mode .....	5-5
Decode Pager Motor Enable .....	5-6
Parameter Bar Code Scanning .....	5-7
Scan Angle .....	5-8
Adaptive Scanning .....	5-9
Interference Suppression Mode .....	5-10
Interference Suppression Scan Angle .....	5-11
Beep After Good Decode .....	5-12
Beeper Tone .....	5-13
Beeper Volume .....	5-14
Hand-Held Trigger Mode .....	5-15
Decode Session Timeout .....	5-15
Picklist Mode .....	5-16
Timeout Between Decodes, Same Symbol .....	5-17
Hand-Held Decode Aiming Pattern .....	5-17
Decoding Illumination (Hand-Held Mode only) .....	5-18
Batch Mode .....	5-19
Modes of Operation .....	5-19
FIPS Mode .....	5-21
DPM Scanning (MT2070-DP only) .....	5-21
Miscellaneous Parameters .....	5-22
Transmit Code ID Character .....	5-22
Prefix/Suffix Values .....	5-23
Scan Data Transmission Format .....	5-24
FN1 Substitution Values .....	5-25
Scan Data Transmission Format (continued) .....	5-25
Transmit "No Read" Message .....	5-26

## Chapter 6: Imaging Preferences

Introduction .....	6-1
Scanning Sequence Examples .....	6-2
Errors While Scanning .....	6-2
Imaging Preferences Parameter Defaults .....	6-2
Imaging Preferences .....	6-4
Operational Modes .....	6-4
Decode Mode .....	6-4
Snapshot Mode .....	6-4

Image Capture Illumination .....	6-5
Snapshot Mode Timeout .....	6-6
Snapshot Aiming Pattern .....	6-6
Image Cropping .....	6-7
Crop to Pixel Addresses .....	6-8
Image Brightness (Target White) .....	6-9
JPEG Quality and Size Value .....	6-9
Image File Format Selector .....	6-10
Signature Capture .....	6-11
Output File Format .....	6-11
Signature Capture File Format Selector .....	6-12
Signature Capture Width .....	6-13
Signature Capture Height .....	6-13
Signature Capture JPEG Quality .....	6-13
Video View Finder .....	6-14

## Chapter 7: Customizing the MT20X0

Introduction .....	7-1
Customizing the Startup Program .....	7-2
Customizing the Home Screen View .....	7-3
Navigator.xml File Content .....	7-4
Customizing the Scan Item or Scan Inventory Program .....	7-5
Disabling MT2000 Scanner Services .....	7-6

## Chapter 8: RS-232 Interface

Introduction .....	8-1
Connecting an RS-232 Interface .....	8-2
RS-232 Parameter Defaults .....	8-3
RS-232 Host Parameters .....	8-4
RS-232 Host Types .....	8-6
Baud Rate .....	8-7
Parity .....	8-9
Stop Bit Select .....	8-10
Data Bits .....	8-10
Check Receive Errors .....	8-11
Hardware Handshaking .....	8-11
Software Handshaking .....	8-13
Host Serial Response Time-out .....	8-15
RTS Line State .....	8-16
Beep on <BEL> .....	8-16
Intercharacter Delay .....	8-17
Nixdorf Beep/LED Options .....	8-18
Ignore Unknown Characters .....	8-18
ASCII Character Set for RS-232 .....	8-19

**Chapter 9: USB Interface**

Introduction .....	9-1
Connecting a USB Interface .....	9-2
USB Parameter Defaults .....	9-3
USB Host Parameters .....	9-5
USB Device Type .....	9-5
CDC COM Port Emulation .....	9-7
Symbol Native API (SNAPI) Status Handshaking .....	9-7
USB Country Keyboard Types - Country Codes .....	9-8
USB Keystroke Delay .....	9-10
USB CAPS Lock Override .....	9-10
USB Ignore Unknown Characters .....	9-11
USB Ignore Beep Directive .....	9-11
USB Ignore Type Directive .....	9-12
Emulate Keypad .....	9-12
Emulate Keypad with Leading Zero .....	9-13
USB Keyboard FN 1 Substitution .....	9-13
Function Key Mapping .....	9-14
Simulated Caps Lock .....	9-14
Convert Case .....	9-15
USB Transmission Speed Parameters .....	9-16
USB Polling Interval .....	9-16
Fast HID Keyboard .....	9-18
Quick Keypad Emulation .....	9-18
USB HID Over the STB2000 Charge-only Cradle .....	9-19
ASCII Character Set for USB .....	9-20

**Chapter 10: IBM 468X / 469X Interface**

Introduction .....	10-1
Connecting to an IBM 468X/469X Host .....	10-2
IBM Parameter Defaults .....	10-3
IBM 468X/469X Host Parameters .....	10-4
Port Address .....	10-4
Convert Unknown to Code 39 .....	10-5

**Chapter 11: Keyboard Wedge Interface**

Introduction .....	11-1
Connecting a Keyboard Wedge Interface .....	11-2
Keyboard Wedge Parameter Defaults .....	11-3
Keyboard Wedge Host Parameters .....	11-4
Keyboard Wedge Host Types .....	11-4
Keyboard Wedge Country Types - Country Codes .....	11-5
Ignore Unknown Characters .....	11-7
Keystroke Delay .....	11-7
Intra-Keystroke Delay .....	11-8
Alternate Numeric Keypad Emulation .....	11-8
Caps Lock On .....	11-9
Caps Lock Override .....	11-9

Convert Wedge Data .....	11-10
Function Key Mapping .....	11-10
FN1 Substitution .....	11-11
Send Make and Break .....	11-11
Keyboard Maps .....	11-12
ASCII Character Set for Keyboard Wedge .....	11-13

## Chapter 12: Symbolologies

Introduction .....	12-1
Scanning Sequence Examples .....	12-1
Errors While Scanning .....	12-2
Symbology Parameter Defaults .....	12-2
UPC/EAN .....	12-7
Enable/Disable UPC-A .....	12-7
Enable/Disable UPC-E .....	12-7
Enable/Disable UPC-E1 .....	12-8
Enable/Disable EAN-8/JAN-8 .....	12-8
Enable/Disable EAN-13/JAN-13 .....	12-9
Enable/Disable Bookland EAN .....	12-9
Decode UPC/EAN/JAN Supplementals .....	12-10
User-Programmable Supplementals .....	12-13
UPC/EAN/JAN Supplemental Redundancy .....	12-13
UPC/EAN/JAN Supplemental AIM ID Format .....	12-14
Transmit UPC-A Check Digit .....	12-14
Transmit UPC-E Check Digit .....	12-15
Transmit UPC-E1 Check Digit .....	12-16
UPC-A Preamble .....	12-16
UPC-E Preamble .....	12-17
UPC-E1 Preamble .....	12-18
Convert UPC-E to UPC-A .....	12-19
Convert UPC-E1 to UPC-A .....	12-19
EAN-8/JAN-8 Extend .....	12-20
Bookland ISBN Format .....	12-21
UCC Coupon Extended Code .....	12-22
Coupon Report .....	12-22
ISSN EAN .....	12-23
Code 128 .....	12-24
Enable/Disable Code 128 .....	12-24
Set Lengths for Code 128 .....	12-24
Enable/Disable GS1-128 (formerly UCC/EAN-128) .....	12-26
Enable/Disable ISBT 128 .....	12-26
ISBT Concatenation .....	12-27
Check ISBT Table .....	12-28
ISBT Concatenation Redundancy .....	12-28
Code 39 .....	12-29
Enable/Disable Code 39 .....	12-29
Enable/Disable Trioptic Code 39 .....	12-29
Convert Code 39 to Code 32 .....	12-30
Code 32 Prefix .....	12-30

Set Lengths for Code 39 .....	12-31
Code 39 Check Digit Verification .....	12-32
Transmit Code 39 Check Digit .....	12-32
Code 39 Full ASCII Conversion .....	12-33
Code 93 .....	12-34
Enable/Disable Code 93 .....	12-34
Set Lengths for Code 93 .....	12-34
Code 11 .....	12-36
Code 11 .....	12-36
Set Lengths for Code 11 .....	12-36
Code 11 Check Digit Verification .....	12-38
Transmit Code 11 Check Digits .....	12-39
Interleaved 2 of 5 (ITF) .....	12-39
Enable/Disable Interleaved 2 of 5 .....	12-39
Set Lengths for Interleaved 2 of 5 .....	12-40
I 2 of 5 Check Digit Verification .....	12-42
Transmit I 2 of 5 Check Digit .....	12-42
Convert I 2 of 5 to EAN-13 .....	12-43
Discrete 2 of 5 (DTF) .....	12-43
Enable/Disable Discrete 2 of 5 .....	12-43
Set Lengths for Discrete 2 of 5 .....	12-44
Codabar (NW - 7) .....	12-46
Enable/Disable Codabar .....	12-46
Set Lengths for Codabar .....	12-46
CLSI Editing .....	12-48
NOTIS Editing .....	12-48
Codabar Upper or Lower Case Start/Stop Characters Detection .....	12-49
MSI .....	12-50
Enable/Disable MSI .....	12-50
Set Lengths for MSI .....	12-50
MSI Check Digits .....	12-52
Transmit MSI Check Digit(s) .....	12-52
MSI Check Digit Algorithm .....	12-53
Chinese 2 of 5 .....	12-53
Enable/Disable Chinese 2 of 5 .....	12-53
Korean 3 of 5 .....	12-54
Enable/Disable Korean 3 of 5 .....	12-54
Inverse 1D .....	12-55
Postal Codes .....	12-56
US Postnet .....	12-56
US Planet .....	12-56
Transmit US Postal Check Digit .....	12-57
UK Postal .....	12-57
Transmit UK Postal Check Digit .....	12-58
Japan Postal .....	12-58
Australian Postal .....	12-59
Australia Post Format .....	12-60
Netherlands KIX Code .....	12-61
USPS 4CB/One Code/Intelligent Mail .....	12-61
UPU FICS Postal .....	12-62

GS1 DataBar .....	12-63
GS1 DataBar-14 .....	12-63
GS1 DataBar Limited .....	12-63
GS1 DataBar Expanded .....	12-64
Convert GS1 DataBar to UPC/EAN .....	12-64
GS1 DataBar Limited Security Level .....	12-65
Composite .....	12-66
Composite CC-C .....	12-66
Composite CC-A/B .....	12-66
Composite TLC-39 .....	12-67
UPC Composite Mode .....	12-67
Composite Beep Mode .....	12-68
2D Symbolologies .....	12-68
Enable/Disable PDF417 .....	12-68
Enable/Disable MicroPDF417 .....	12-69
Code 128 Emulation .....	12-70
Data Matrix .....	12-71
Maxicode .....	12-71
QR Code .....	12-72
MicroQR .....	12-72
Aztec .....	12-73
Redundancy Level .....	12-74
Redundancy Level 1 .....	12-74
Redundancy Level 2 .....	12-74
Redundancy Level 3 .....	12-74
Redundancy Level 4 .....	12-75
Security Level .....	12-76
Report Version .....	12-77

### Chapter 13: Accessories

Introduction .....	13-1
Maintenance .....	13-2
Batteries .....	13-2
Mounting .....	13-2
Single Slot Cradles .....	13-3
Cradle Features .....	13-3
Battery Charging in the Cradle .....	13-3
Changing the Host Interface .....	13-3
Communication .....	13-4
Sending Data to the Host Computer .....	13-4
LED Indicators .....	13-5
Miscellaneous LED Indicator Information .....	13-5
Four Slot Cradles .....	13-6
Cradle Features .....	13-6
Inserting Devices and Batteries in the Cradle .....	13-6
Removing the Device from the Four Slot Cradle .....	13-6
Sending Data to the Host Computer .....	13-7
Charging .....	13-7
LED Indicators .....	13-7

Four Slot Battery Charger .....	13-8
Features .....	13-8
Inserting Batteries .....	13-8
Charging Batteries .....	13-8
LED Indicators .....	13-9
Troubleshooting .....	13-10

## Chapter 14: Advanced Data Formatting

Introduction .....	14-1
Rules: Criteria Linked to Actions .....	14-1
Using ADF Bar Codes .....	14-2
ADF Bar Code Menu Example .....	14-2
Rule 1: The Code 128 Scanning Rule .....	14-3
Rule 2: The UPC Scanning Rule .....	14-3
Alternate Rule Sets .....	14-3
Rules Hierarchy (in Bar Codes) .....	14-4
Default Rules .....	14-5
ADF Bar Codes .....	14-5
Special Commands .....	14-8
Pause Duration .....	14-8
Begin New Rule .....	14-8
Save Rule .....	14-9
Erase .....	14-9
Quit Entering Rules .....	14-9
Disable Rule Set .....	14-10
Criteria .....	14-11
Code Types .....	14-11
Code Lengths .....	14-18
Message Containing A Specific Data String .....	14-22
Specific String at Start .....	14-22
Specific String, Any Location .....	14-23
Any Message OK .....	14-23
Numeric Keypad .....	14-24
Rule Belongs To Set .....	14-26
Actions .....	14-27
Send Data .....	14-27
Setup Field(s) .....	14-30
Move Cursor .....	14-31
Send Pause .....	14-32
Skip Ahead .....	14-33
Skip Back .....	14-34
Send Preset Value .....	14-36
Modify Data .....	14-37
Remove All Spaces .....	14-37
Crunch All Spaces .....	14-37
Stop Space Removal .....	14-37
Remove Leading Zeros .....	14-37
Stop Zero Removal .....	14-37
Pad Data with Spaces .....	14-38

Pad Data with Zeros .....	14-42
Beeps .....	14-47
Send Keystroke (Control Characters and Keyboard Characters) .....	14-47
Control Characters .....	14-47
Keyboard Characters .....	14-52
Send ALT Characters .....	14-66
Send Keypad Characters .....	14-71
Send Function Key .....	14-76
Send Right Control Key .....	14-83
Send Graphic User Interface (GUI) Characters .....	14-84
Turn On/Off Rule Sets .....	14-89
Alphanumeric Keyboard .....	14-91

**Chapter 15: Maintenance and Troubleshooting**

Introduction .....	15-1
Maintenance .....	15-1
MT20X0 .....	15-1
Battery .....	15-2
Cradles .....	15-2
Troubleshooting .....	15-3
MT20X0 .....	15-3
Single Slot Charge Only Cradle .....	15-7
Single Slot Charge Only Vehicle Mount .....	15-8
Single Slot Charge Multi-interface .....	15-9
Four Slot Charge Only Ethernet .....	15-11
Four Slot Charge Only Cradle .....	15-12
Four Slot Spare Battery Charger .....	15-13
Cables .....	15-14
MCL .....	15-15

**Appendix A: Standard Default Parameters**

**Appendix B: Programming Reference**

Symbol Code Identifiers .....	B-1
AIM Code Identifiers .....	B-3

**Appendix C: Sample Bar Codes**

UPC-A .....	C-1
UPC-E .....	C-1
UPC-E1 .....	C-2
EAN-13 .....	C-2
EAN-8 .....	C-2
Code 39 .....	C-2
Trioptic Code 39 .....	C-3
Code 93 .....	C-3
Code 11 .....	C-3



Code 128 .....	C-4
Codabar .....	C-4
MSI .....	C-4
Interleaved 2 of 5 .....	C-4
PDF417 .....	C-5
Data Matrix .....	C-5
Maxicode .....	C-5
QR Code .....	C-6
US Postnet .....	C-6
UK Postal .....	C-6

#### Appendix D: Numeric Bar Codes

0, 1, 2, 3 .....	D-1
4, 5, 6, 7 .....	D-2
8, 9 .....	D-3
Cancel .....	D-3

#### Appendix E: Alphanumeric Bar Codes

Alphanumeric Keyboard .....	E-1
-----------------------------	-----

#### Appendix F: Signature Capture Code

Introduction .....	F-1
Code Structure .....	F-1
Signature Capture Area .....	F-1
CapCode Pattern Structure .....	F-2
Start / Stop Patterns .....	F-2
Dimensions .....	F-3
Data Format .....	F-3
Additional Capabilities .....	F-4
Signature Boxes .....	F-4

#### Appendix G: Quick Startup Exercises

Introduction .....	G-1
Establishing an ActiveSync Connection .....	G-2
Using the STB2000 Cradle and USB Cable .....	G-2
Using Only a USB Cable .....	G-2
Establishing a Bluetooth (BT) Connection Using Open Bluetooth .....	G-3
Establishing a Bluetooth (BT) Connection Using the STB2070 Cradle .....	G-4
Using the Scan Item Application with the STB2078 Cradle .....	G-4
Using the Scan Inventory Application with the STB2078 Cradle .....	G-4
Customizing the Home Screen Menu .....	G-5
Modifying the Startup Program .....	G-5
Disabling Scanner Services .....	G-5

**Index**

**Glossary**

**Tell Us What You Think**

# About This Guide

---

## Introduction

This guide provides information about using the MT2070/MT2090 devices.



**NOTE** Screens and windows pictured in this guide are samples and can differ from actual screens.

## Documentation Set

The documentation set for the MT2070/MT2090 devices provides information for specific user needs, and includes: /

- **MT2070/ MT2090 Quick Start Guide** - describes how to get the device up and running (part number 72-117308-xx).
- **MT2070/ MT2090 User Guide** - describes how to use the device (part number 72E-117859-xx).
- **MT2070/ MT2090 Integrator Guide** - describes how to set up the device and accessories (72E-117858-xx).
- **Enterprise Mobility Developer Kit (EMDK) Help File** - provides API information for writing applications.
- **MCL Technologies Start-up guide for the MT2000** - provides start up information for running MCL on an MT20X0 device.

## Device Configurations

Configuration	Radios	Display	Memory	Data Capture	Operating System	Keypad
MT2090-ML4D62170WR	802.11/Bluetooth	320x240 Color	64 MB RAM 64 MB Flash	1D, Medium Range, WW	Windows CE 5.0	21 key
MT2090-SD4D62170WR	802.11/Bluetooth	320x240 Color	64 MB RAM 64 MB Flash	1D/2D, Standard Range	Windows CE 5.0	21 key
MT2090-HD4D62170WR	802.11/Bluetooth	320x240 Color	64 MB RAM 64 MB Flash	1D/2D, High Definition	Windows CE 5.0	21 key
MT2090-DP4D62170WR	802.11/Bluetooth	320x240 Color	64 MB RAM 64 MB Flash	DPM	Windows CE 5.0	21 key
MT2070-ML4D62370WR	Bluetooth	320x240 Color	64 MB RAM 64 MB Flash	1D, Medium Range, MCL	Windows CE 5.0	21 key
MT2070-SD4D62370WR	Bluetooth	320x240 Color	64 MB RAM 64 MB Flash	1D/2D, Standard Range, MCL	Windows CE 5.0	21 key
MT2070-HD4D62370WR	Bluetooth	320x240 Color	64 MB RAM 64 MB Flash	1D/2D,HD, MCL	Windows CE 5.0	21 key
MT2070-DP4D62370WR	Bluetooth	320x240 Color	64 MB RAM 64 MB Flash	DPM, MCL	Windows CE 5.0	21 key

## Cradle Configurations

Cradle Configuration	Type	Radio
STB2000-C10007R	Single Slot, Charge Only with ActiveSync	N/A
STB2000-F10007R	Single Slot, Charge Only, Vehicle Mount	N/A
STB2078-C10007WR	Single Slot, Charge, Multi-interface	Bluetooth
STB2000-C40007R	Four Slot, Charge Only	N/A
STB2000-C40017R	Four Slot, Charge, Ethernet	N/A
SAC2000-4000CR Charger	Four Slot Spare Battery Charger	N/A

---

## Chapter Descriptions

Topics covered in this guide are as follows:

- [Chapter 1, Getting Started](#) provides a product overview, unpacking instructions and start up information.
- [Chapter 2, Operating the MT2070/MT2090](#) describes the device's screens, and how to use the device.
- [Chapter 3, Scanning](#) describes parts of the device, beeper and LED definitions, and how to scan data.
- [Chapter 4, Radio Communications](#) provides information about the modes of operation and features available for wireless communication between devices, cradles and hosts, and also includes the parameters necessary to configure the device.
- [Chapter 5, User Preferences & Miscellaneous Scanner Options](#) describes each user preference feature and provides the programming bar codes for selecting these features for the device. It also includes commonly used bar codes to customize how data is transmitted to the host device.
- [Chapter 6, Imaging Preferences](#) describes each imager preference feature and provides the programming bar codes for selecting these features for the device.
- [Chapter 7, Customizing the MT20X0](#) provides information about customizing the MT20X0 device for the end user.
- [Chapter 8, RS-232 Interface](#) provides information for setting up the device for RS-232 operation.
- [Chapter 9, USB Interface](#) provides information for setting up the device for USB operation.
- [Chapter 10, IBM 468X / 469X Interface](#) provides information for setting up the device with IBM 468X/469X POS systems.
- [Chapter 11, Keyboard Wedge Interface](#) provides information for setting up the device for keyboard wedge operation.
- [Chapter 12, Symbologies](#) describes all symbology features and provides the programming bar codes for selecting these features.
- [Chapter 13, Accessories](#) describes all accessories for the device.
- [Chapter 14, Advanced Data Formatting \(ADF\)](#) describes how to customize scanned data before transmitting to the host.
- [Chapter 15, Maintenance and Troubleshooting](#) provides information on how to care for the device and troubleshooting the device and its cradles.
- [Appendix A, Standard Default Parameters](#) provides a table of all host devices and miscellaneous device defaults.
- [Appendix B, Programming Reference](#) provides a table of AIM code identifiers, ASCII character conversions, and keyboard maps.
- [Appendix C, Sample Bar Codes](#) includes sample bar codes.
- [Appendix D, Numeric Bar Codes](#) includes the numeric bar codes to scan for parameters requiring specific numeric values.
- [Appendix E, Alphanumeric Bar Codes](#) includes the alphanumeric bar codes to scan for parameters requiring alphanumeric values.
- [Appendix F, Signature Capture Code](#) provides information about using the device to capture a signature.
- [Appendix G, Quick Startup Exercises](#) provides exercises to familiarize the user with the device and accessories. Exercises include establishing connections (ActiveSync and Bluetooth), customizing the Home Screen menu, modifying the Startup program, remapping the keypad and disabling Scanner Services.

## Notational Conventions

The following conventions are used in this document:

- *Italics* are used to highlight the following:
  - Chapters and sections in this and related documents
- **Bold** text is used to highlight the following:
  - Key names on a keypad
  - Button names on a screen or window.
- bullets (•) indicate:
  - Action items
  - Lists of alternatives
  - Lists of required steps that are not necessarily sequential
- Sequential lists (e.g., those that describe step-by-step procedures) appear as numbered lists.
- Throughout the programming bar code menus, asterisks (\*) are used to denote default parameter settings.

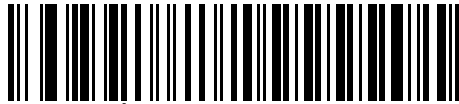

\* Indicates Default ————— \* **Baud Rate 9600** ————— Feature/Option



**NOTE** This symbol indicates something of special interest or importance to the reader. Failure to read the note will not result in physical harm to the reader, equipment or data.



**CAUTION** This symbol indicates that if this information is ignored, the possibility of data or material damage may occur.



**WARNING!** This symbol indicates that if this information is ignored the possibility that serious personal injury may occur.

---

## Related Documents

The following documents provide more information about the MT2070/MT2090 devices.

- *MT2070/MT2090 Quick Start Guide* (part number 72-117308-xx) - describes how to get the device up and running.
- *MT2070/MT2090 User Guide*, part number 72E-117859-xx - describes how to use the device.
- *MT2070/MT2090 Integrator Guide*, part number 72E-117858-xx- describes how to set up the device and accessories.
- *STB2000/SAC2000 Cradles Quick Reference Guide* (part number 72-117312-xx) - describes how to install and operate the cradles.

For the latest version of this guide and all guides, go to: <http://www.zebra.com/support>.

---

## Service Information

If you have a problem using the equipment, contact your facility's technical or systems support. If there is a problem with the equipment, they will contact the Zebra Global Customer Support Center at: <http://www.zebra.com/support>.

When contacting Zebra support, please have the following information available:

- Serial number of the device
  - Device serial numbers are located on the label under the top of the device
  - Cradles serial numbers are located on the label on the bottom of the cradle
- Model number or product name
  - Device model numbers are located on the label under the top of the device
  - Cradle model numbers are located on the label on the bottom of the cradle
- Software type and version number
  - See *Figure 2-10 on page 2-16*.

Zebra responds to calls by e-mail, telephone or fax within the time limits set forth in support agreements.

If your problem cannot be solved by Zebra Support, you may need to return your equipment for servicing and will be given specific directions. Zebra is not responsible for any damages incurred during shipment if the approved shipping container is not used. Shipping the units improperly can possibly void the warranty.

If you purchased your business product from a Zebra business partner, contact that business partner for support.





# Chapter 1 Getting Started

---

## Introduction

This chapter lists the features of the device(s); accessories for the MT2000 Series devices; explains how to install and charge the batteries; power the cradles; and, replace the lanyard (if purchased).

---

## Unpacking

Carefully remove all protective material from around the equipment and inspect it for damage. If the equipment was damaged in transit, contact Zebra Support. See [page xxiii](#) for contact information. **KEEP THE PACKING.** It is the approved shipping container and should be used if the equipment ever needs to be returned for servicing.

### MT20X0

Verify that the equipment listed below is included in the box:

- MT2070/MT2090
- Lithium-ion (Li-ion) battery
- Quick Start Guide.

### Cradles

#### **STB2000-C10007R Single Slot Charge Only with ActiveSync**

Verify that the equipment listed below is included in the box:

- Cradle with desk mount cup installed
- Wall mount cup
- Regulatory Guide.

#### **STB2000-F10007R Forklift Single Slot Charge Only**

Verify that the equipment listed below is included in the box:

- Cradle with forklift cup installed
- Metal mounting bracket with isolators
- Quick Reference Guide.

### **STB2078-C10007WR Single Slot Multi-interface Bluetooth**

Verify that the equipment listed below is included in the box:

- Cradle with desk mount cup installed
- Wall mount cup
- Quick Reference Guide.

### **STB2000-C40007R Four Slot Charge Only**

Verify that the equipment listed below is included in the box:

- Cradle with wall mount cups installed
- Quick Reference Guide.

### **STB2000-C40017R Four Slot Ethernet**

Verify that the equipment listed below is included in the box:

- Cradle with wall mount cups installed
- Quick Reference Guide.

### **SAC2000-4000CR Four Slot Spare Battery Charger**

Verify that the equipment listed below is included in the box:

- Charger
- Quick Reference Guide.

---

## **Accessories**

See [Chapter 13, Accessories](#) for a list all accessories available for the MT2070/MT2090 devices.

## Features

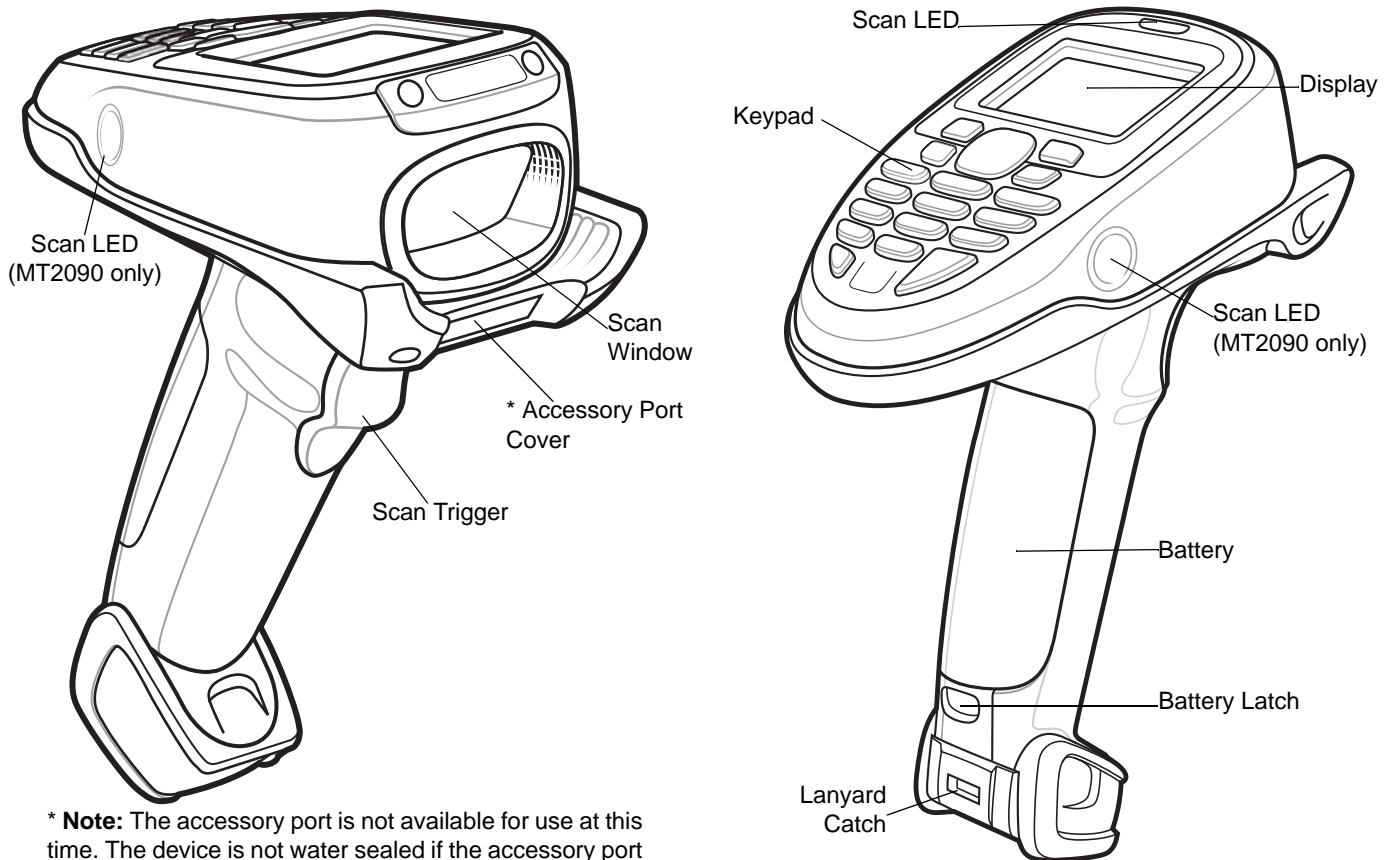

\* **Note:** The accessory port is not available for use at this time. The device is not water sealed if the accessory port cover is removed.

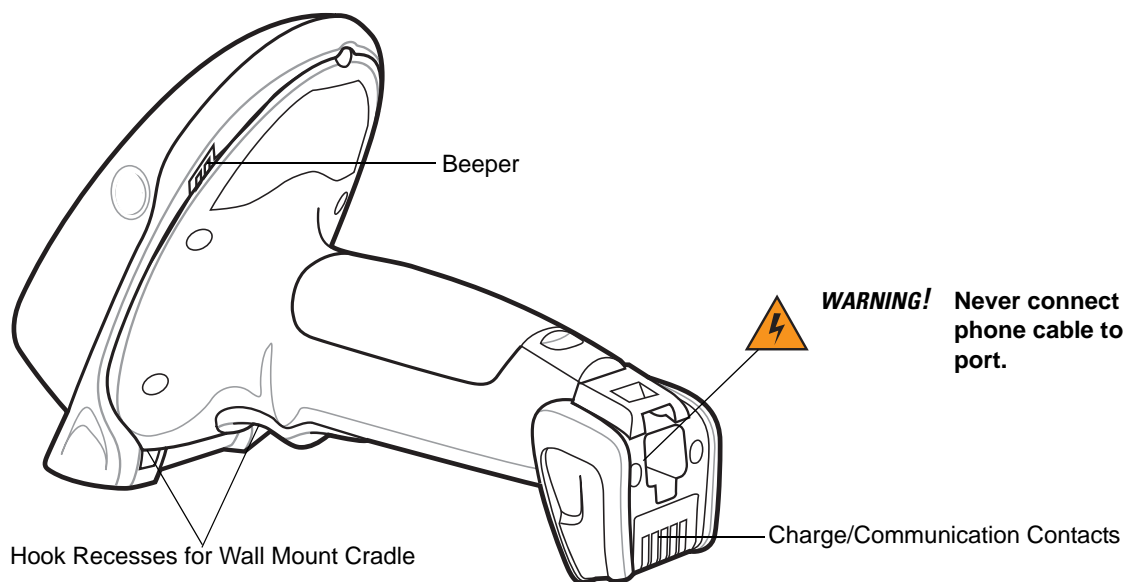

**WARNING!** Never connect an Ethernet or phone cable to the host interface port.

Figure 1-1 MT2070/MT2090

## Cradle Features

### Single Slot - Front View and Connections

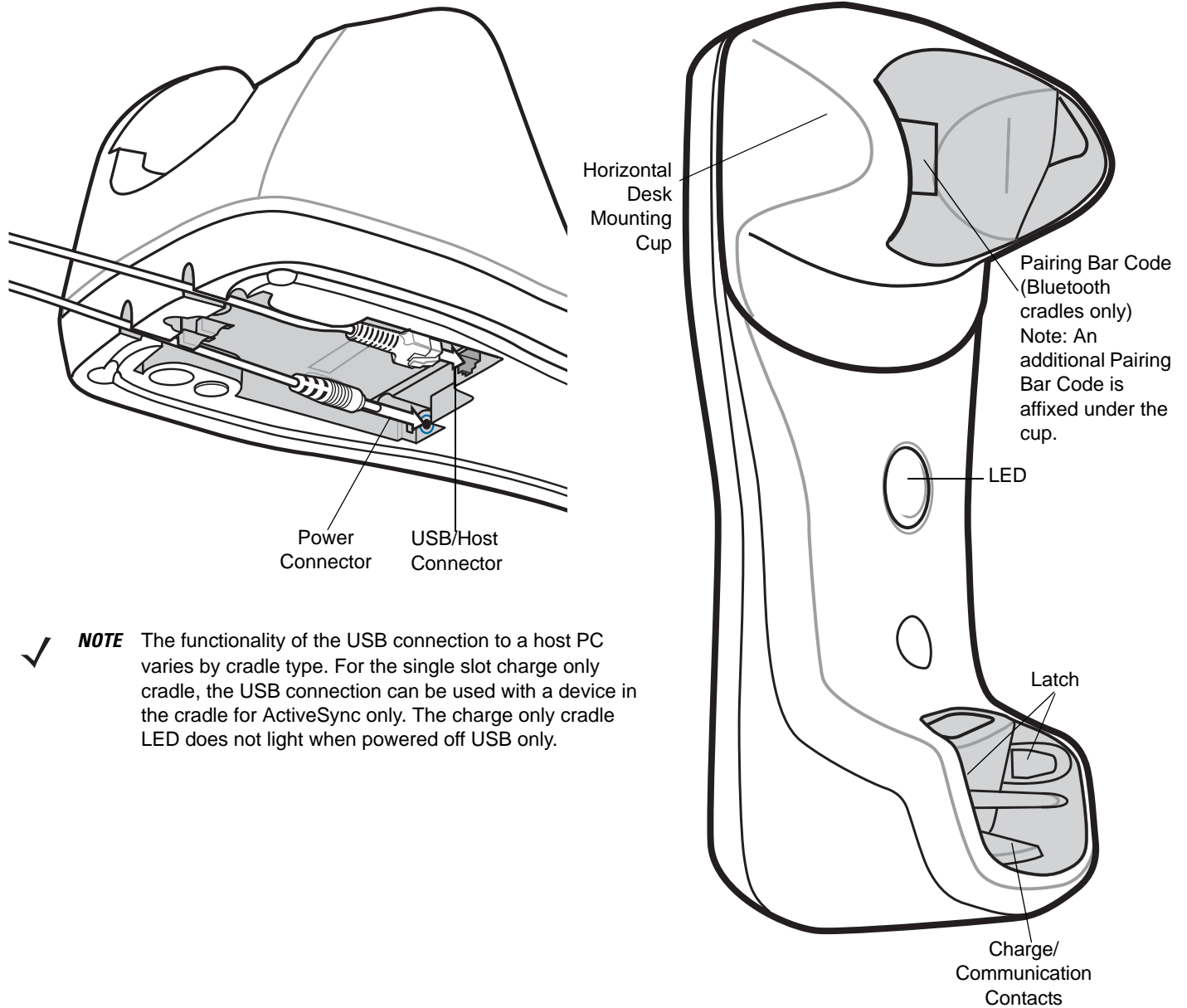

✓ **NOTE** The functionality of the USB connection to a host PC varies by cradle type. For the single slot charge only cradle, the USB connection can be used with a device in the cradle for ActiveSync only. The charge only cradle LED does not light when powered off USB only.

Figure 1-2 Single Slot Cradle - Connections/Pairing Bar Code

## Single Slot - Back View

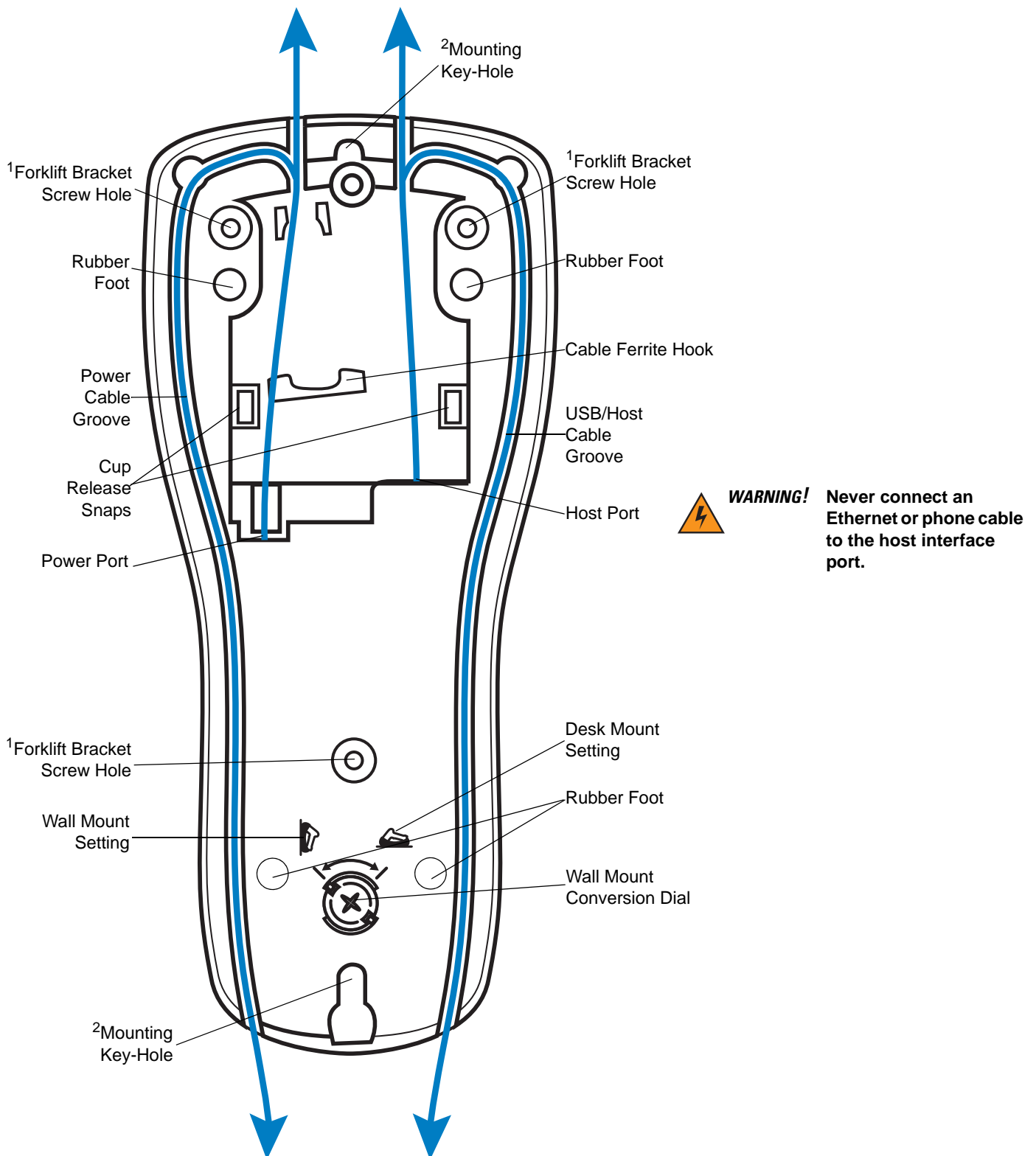

<sup>1</sup> Used to fasten bracket to STB2000-F (forklift) cradle.

<sup>2</sup> Used to mount STB20XX cradle.

**Figure 1-3** Single Slot Cradle - Back

### Single Slot - Mounting Cups

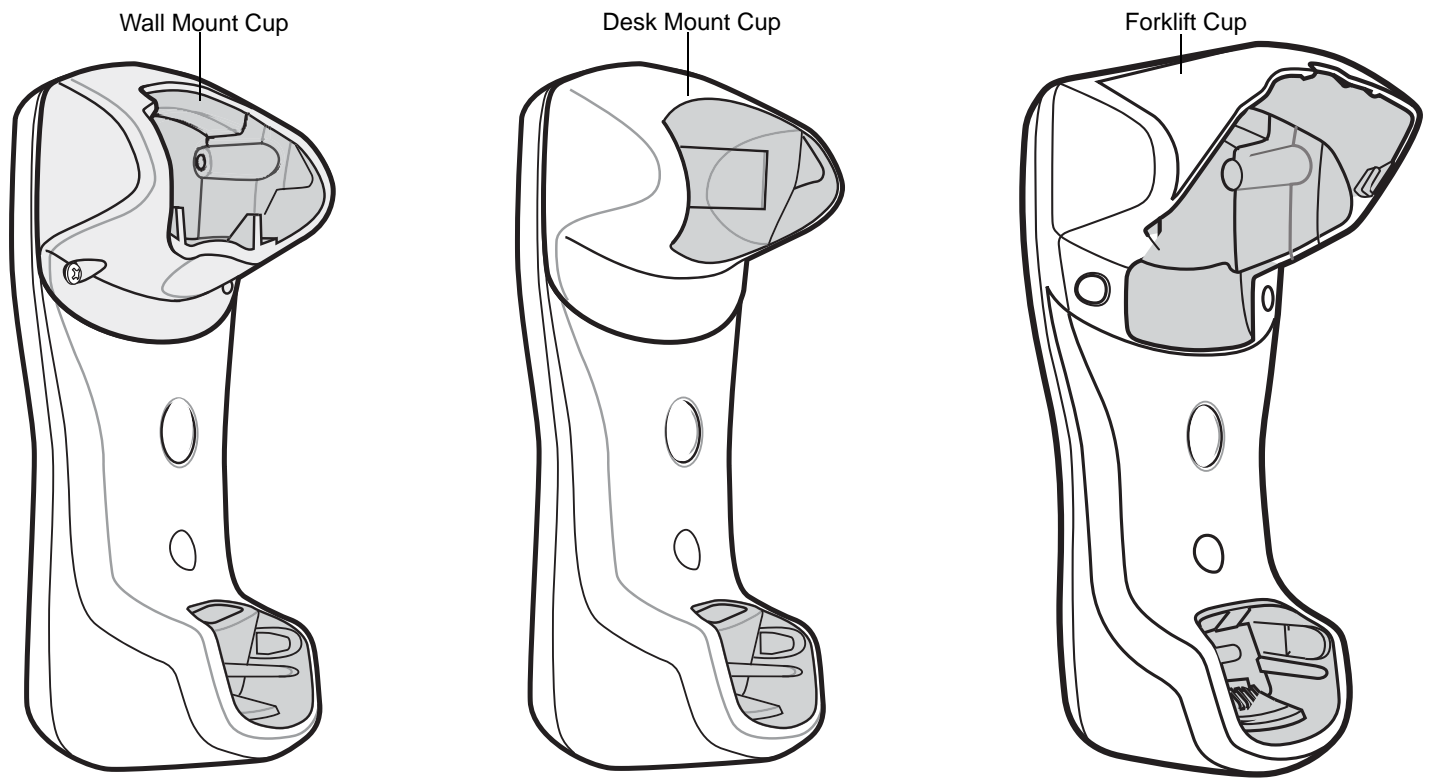

**Figure 1-4** Single Slot Cradle - Mounting Cups

## Four Slot - Front View and Connections

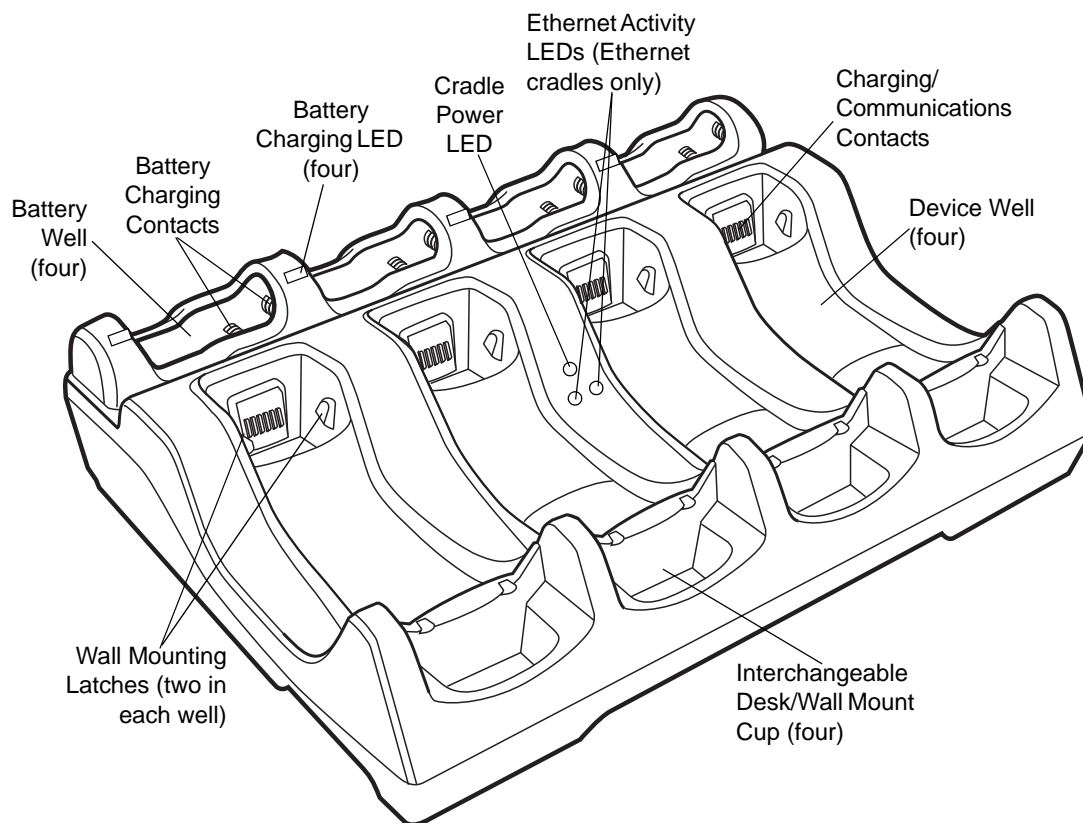

**Figure 1-5** *Four Slot Cradle - Front*

### Four Slot - Back View

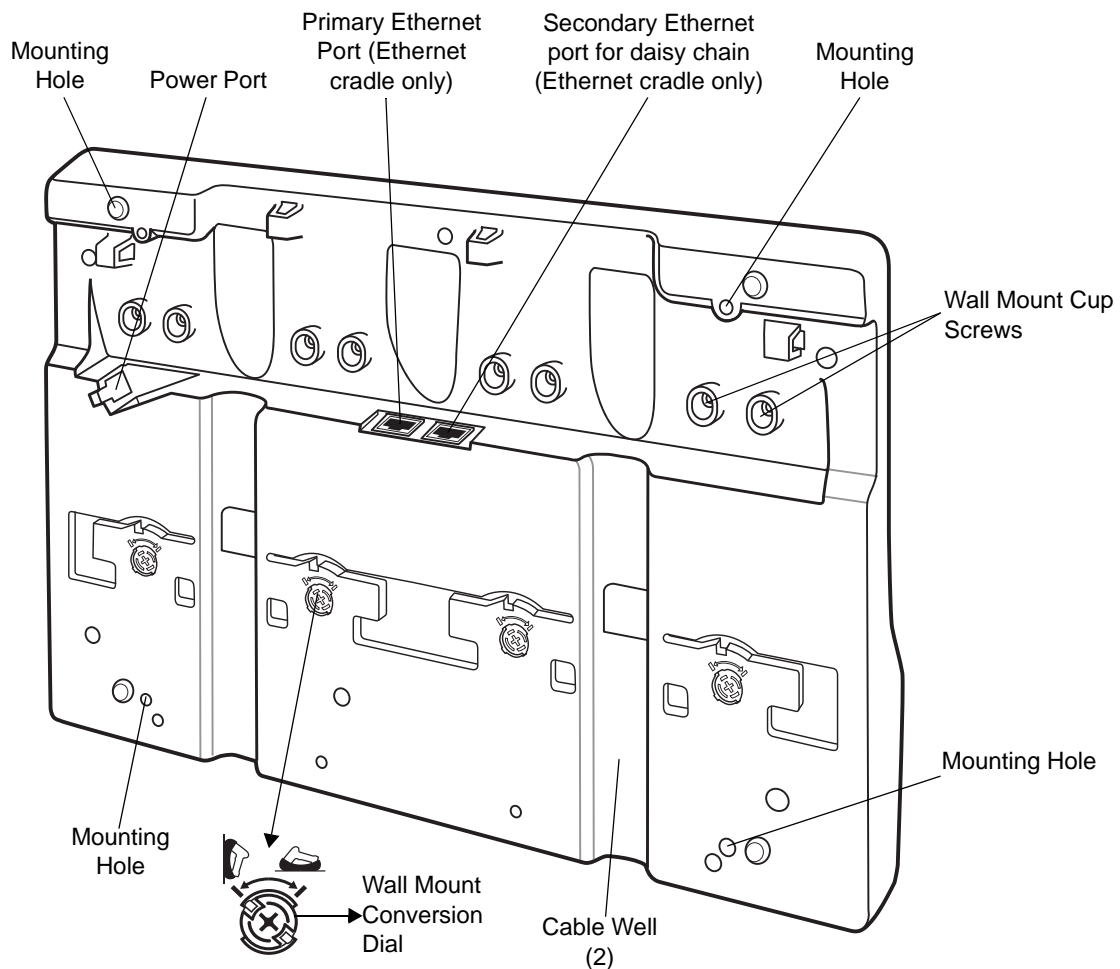
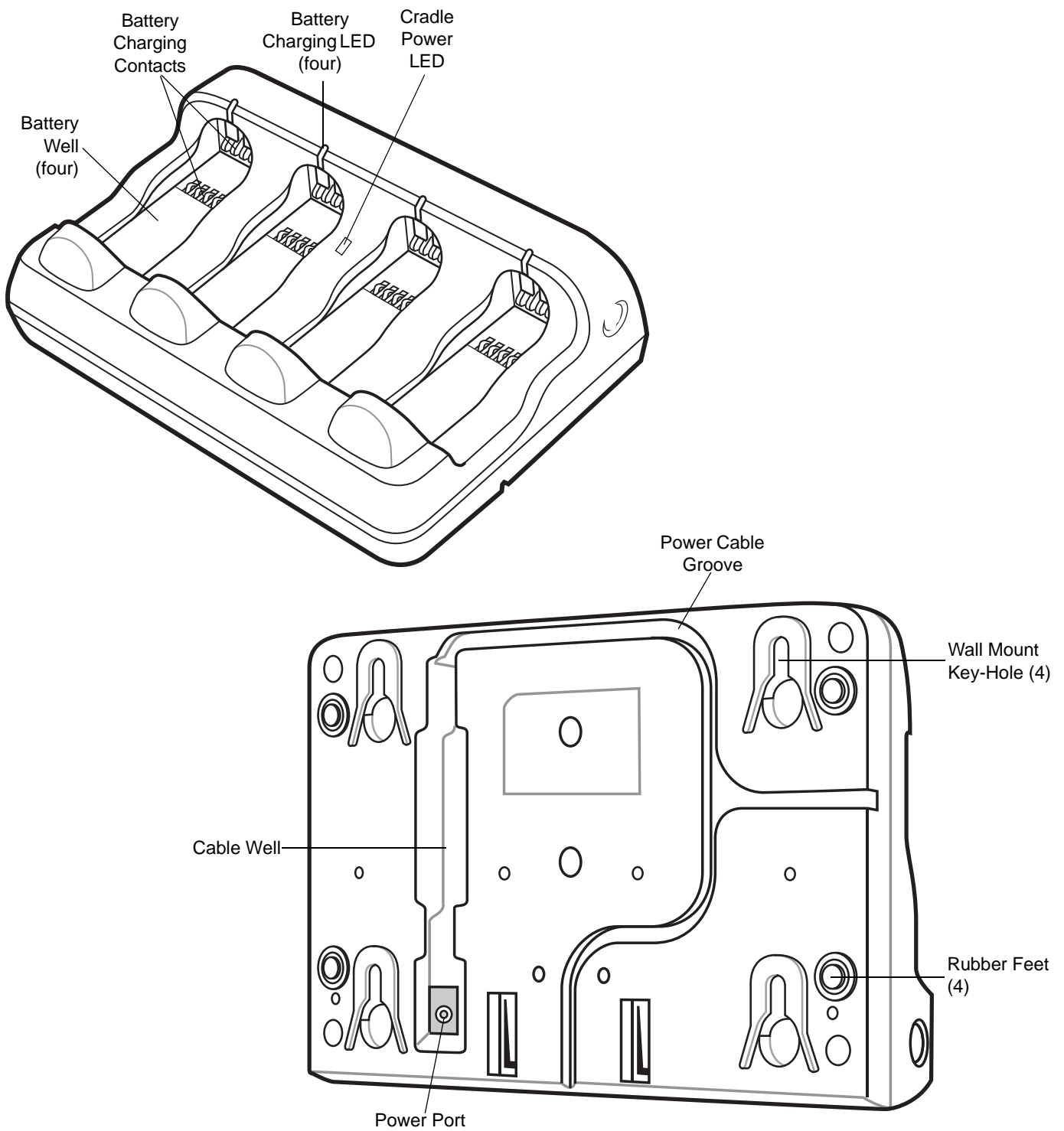

**Figure 1-6** Four Slot Cradle - Back

✓ **NOTE** When daisy chaining Ethernet cradles: connect the first cradle in the daisy chain to the Ethernet hub via the primary Ethernet port; connect the first cradle's secondary port to the primary port of second cradle in the chain; connect the second cradle's secondary port to the primary port of third cradle in the chain; etc. Each cradle in the daisy chain requires its own power supply.



### Four Slot Spare Battery Charger



**Figure 1-7** Four Slot Spare Battery Charger

---

## Host Interfaces

This device supports the following host interfaces through communication with a single slot multi-interface cradle:

- Standard RS-232 connection to a host.
- Keyboard wedge connection to a host, where scanned data is interpreted as keystrokes. The following international keyboards are supported (for Windows™ environment): North American, German, French, French Belgian, French Canadian, Spanish, Italian, Swedish, UK English, Japanese, and Brazilian Portuguese (see [Keyboard Wedge Country Types - Country Codes on page 11-5](#) for a full list).
- IBM® 468X/469X hosts.
- USB connection to a host. The device autodetects a USB host and defaults to the HID keyboard interface type. Select other USB interface types by scanning programming bar codes. The following international keyboards are supported (for Windows™ environment): North America, German, French, French Belgian, French Canadian, Spanish, Italian, Swedish, UK English, Japanese, and Brazilian Portuguese (see [USB Country Keyboard Types - Country Codes on page 9-8](#) for a full list).

✓ **NOTE** USB interface types can also be selected via the USB configuration menu on the device. To access the USB configuration menu from the device's *Home* screen, select *Config... > Configure USB*.

This device supports the following host interfaces without communication with a cradle:

- Standard RS-232 connection to a host.
- USB connection to a host via Bluetooth technology. The device autodetects a USB host and defaults to the HID keyboard interface type. Select other USB interface types by scanning programming bar codes. The following international keyboards are supported (for Windows™ environment): North America, German, French, French Belgian, French Canadian, Spanish, Italian, Swedish, UK English, Japanese, and Brazilian Portuguese.

✓ **NOTE** USB interface types can also be selected via the USB configuration menu on the device. To access the USB configuration menu from the device's *Home* screen, select *Config... > Configure USB*.

---

## Out-of-Box Startup

To get the MT2070/MT2090 up and running:

- Insert the rechargeable Li-ion battery
- Connect power to the cradle.
- Insert the device in the cradle.
- Charge the device.
- Configure the device.

## Insert the Battery

The battery resides in a chamber in the device handle.

- ✓ **NOTE** If the battery is completely discharged, and the unit is powered from a USB or RS232 cable, it may take up to two hours for the unit to power up. There is no indication to the user of this condition and it may appear that the unit is not charging and/or not working correctly. However, if the unit is placed in an STB2000 cradle with the 12V power supply power up is immediate.

To insert the battery:

1. Insert the battery into the battery well, top first, ensuring that the battery connectors touch the device connectors inside the well.



**CAUTION** Avoid touching the contacts when positioning the battery.

2. Push down on the back of the battery until it snaps into place.

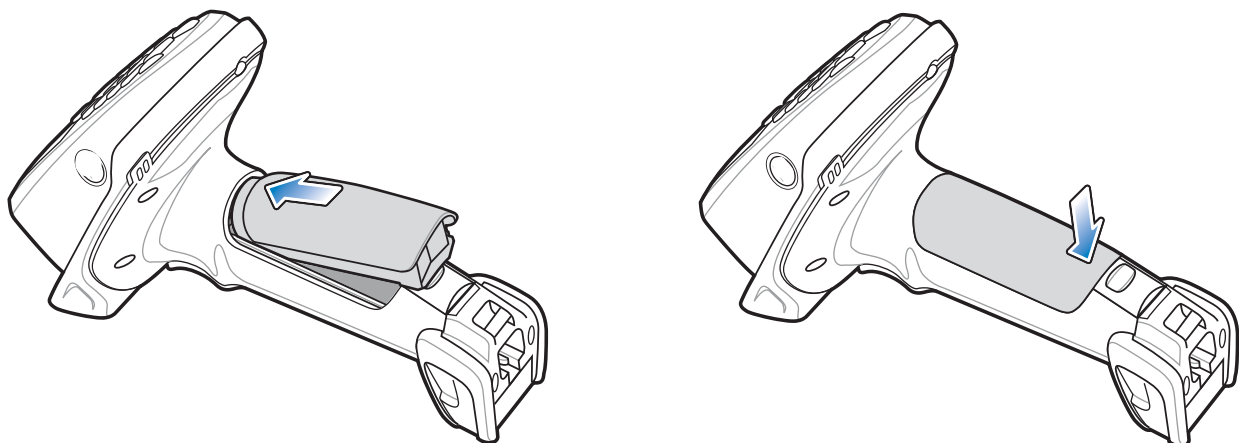

Figure 1-8 Battery Insertion

## Connect the Cradle



**IMPORTANT** Connect the interface cable and power supply (if necessary) in the following order to ensure proper operation of the device and cradle.

### Connecting the STB20XX Cradle

1. Insert the host interface cable into the cradle's USB/host port. See [Figure 1-2 on page 1-4](#) and [Figure 1-5 on page 1-7](#).
2. Connect the other end of the host interface cable to the host.
3. If necessary, connect the power supply to the cradle's power port (if the interface requires, or to allow fast charging of the device).
4. Connect the appropriate cable to the power supply and an AC power source, if necessary.
5. If applicable, insert the power supply cable ferrite into the support features on the cradle bottom and run the host and power cables into their respective cable grooves.
6. For Bluetooth cradles only, pair the device to the cradle by scanning the pairing bar code on the cradle.

7. If necessary, scan the appropriate host bar code (for non-autodetected interfaces). See the specific host chapter.

✓ **NOTE** Disconnect the power supply before changing host cables, or the device may not recognize the new host.

Different cables are required for different hosts. The connectors illustrated in each host chapter are examples only. The connectors may be different from those illustrated, but the steps to connect the device remain the same.

### Connecting STB2000-F Cradle

1. Insert the host interface cable into the cradle's USB/host port. See [Figure 1-2 on page 1-4](#).
2. Connect the forklift power supply to the cradle's power port, if applicable.
3. Optionally: Insert the power supply cable ferrite into the support features on the cradle bottom and run the host and power cables into their respective cable grooves, or use cable ties to secure them to the mounting plate after attaching it to the cradle. For more information about mounting options and procedures, refer to the documentation included with the cradle.
4. If necessary, scan the appropriate host bar code (for non-autodetected interfaces). See the specific host chapter.

### Changing the Host Interface

To connect to a different host, or to the same host using a different cable:

1. Disconnect the power supply from the cradle, if used.
2. Disconnect the interface cable from the host.
3. Connect the interface cable to the new host, or the new interface cable to the existing host.
4. Reconnect the power supply, if required.
5. If necessary, scan the appropriate host bar code (for non-autodetected interfaces). See the specific host chapter.



**CAUTION** If the device does not recognize the host, disconnect the power supply, then reconnect after connecting the host cable.

### Supplying Power to the Cradle

The cradle receives power from one of two sources:

- An external power supply.
- When connected to the host through an interface cable that supplies power.

The cradle detects whether the host or the external supply is supplying power. It always draws power from the external supply when available, regardless of the presence of power from a host.

### Using the USB Interface to Supply Power

When the cradle is connected to the host via the USB interface, the USB port can power the cradle and an external power supply is not necessary. Note that powering from a USB host charges the device at a slower rate than charging from an external power supply. Additionally, depending on the level of activity, the device may not charge at all.

## Insert the Device in the Cradle

To insert the device in the cradle:

1. Insert the device into the cradle top first.
2. Push the handle until it clicks into place, engaging the contacts in the cradle and device.

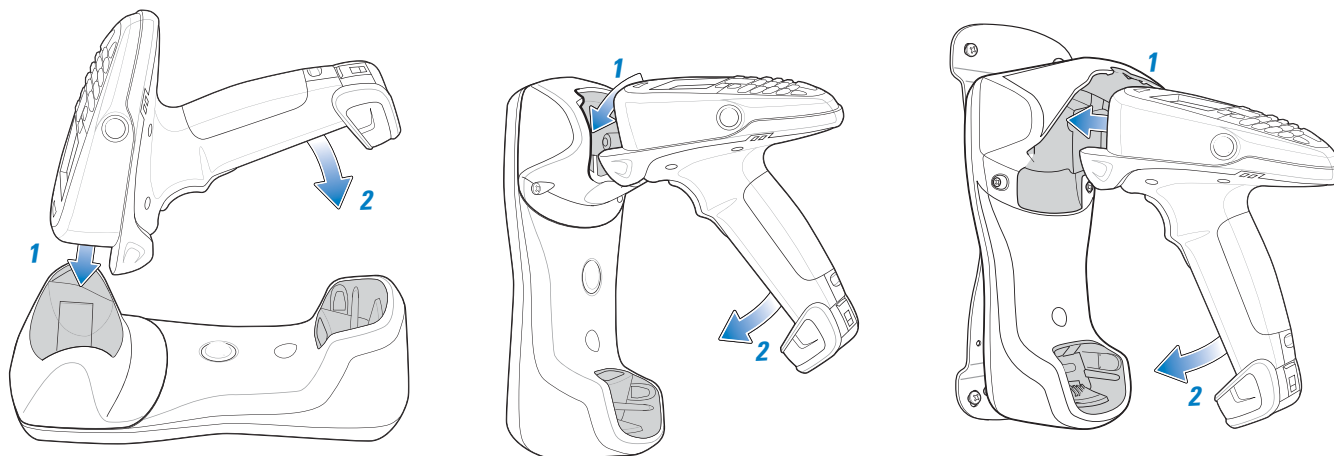

**Figure 1-9** Inserting the Device in the Single Slot Cradles

- ✓ **NOTE** When inserting the device in a wall mounted cradle, ensure the device's hook recesses engage the hooks on the wall mount adapter (when applicable).

## Removing the Device from a Vertical Mount Cradle (Forklift or Wall Mount)

To remove the scanner from a vertically mounted cradle, remove the bottom of the scanner first then gently pull the top of the scanner out of the cradle.

## Charge the Device Battery in the Cradle

For best performance, fully charge the device battery before using the device for the first time. To charge the device battery, place the device in the cradle (see [Insert the Device in the Cradle on page 1-13](#)). The battery begins charging when the device LED indicator starts flashing green. (With the exception of several initial charge cycles, the default state of the LED is off when the battery is fully charged.) A complete charge of a fully discharged battery can take up to four hours using external power and up to 10 hours using the interface cable.



Charge within the recommended temperature of 32° to 104° F (0° to 40° C) nominal, 41° to 95° F (5° to 35° C) ideal.

For information on maximizing battery life, see [Battery on page 15-2](#).

- ✓ **NOTE** The default state of the LED is off when the battery is fully charged with the exception of several initial charge cycles. The LED may continually blink until the battery goes through several discharge cycles to calibrate itself.

### Charging Indicator/LED

The device has on screen charging indicators as well as an LED. The device's flashing green LED indicates charging activity.

If the device displays  or  indicating a charging problem, remove the device from the cradle and replace the battery. If one of these icons continues to display, contact Zebra Support. See [Screen Icons on page 2-9](#) for descriptions of display icons.

## Configure the Device

Use the bar codes in this manual to configure the device. See [Chapter 5, User Preferences & Miscellaneous Scanner Options](#), [Chapter 6, Imaging Preferences](#) and each host chapter for information about programming the device using bar code menus.

## Battery Charging



**IMPORTANT** 1) If the host PC is powered off, for example every night, the device continues to operate from its battery until the battery is totally drained. Upon restart of the host PC, the device may not boot. The battery has to charge at a reduced charge rate until the battery acquires sufficient charge to boot the device. This can take up to two hours, depending on the level of discharge.

2) To prevent irreversible harm to battery do not store the device with the battery installed for extended periods of time. For maximizing battery life, see [Battery on page 15-2](#).

Charge the device using a cradle or host interface cable, or remove and charge the Li-ion battery using a spare battery charger.

Before using the device for the first time, fully charge the Li-ion battery until the green LED on the device goes off (default). The battery fully charges in less than four hours, when the device is placed in a cradle with a 12V supply connected.



**NOTE** The default state of the LED is off when the battery is fully charged with the exception of several initial charge cycles. The LED may continually blink until the battery goes through several discharge cycles to calibrate itself.

This device does not have a backup battery. Any data in RAM is lost when the battery is removed. However, the real-time clock is maintained for a period of 20 minutes during a battery change.

Use the following accessories to charge the Li-ion battery:

- Cradles:
  - Single Slot USB Charge Only Cradle - with power supply for fast charging
  - Single Slot Multi-interface Bluetooth Cradle - with power supply; powered from host (slow charge)
  - Four Slot Charge Only Cradle - with power supply
  - Four Slot Ethernet Cradle - with power supply.
- Spare Battery Charger:
  - Four Slot Battery Charger - with power supply.
- Cables (and a power supply):
  - USB Client Charge Cable
  - RS-232 Serial Cable - with power supply.

Use a cradle or a charge cable to charge the Li-ion battery in the device. Use either the four slot cradle or four slot battery charger to charge up to four spare batteries. The charge cable requires a Zebra approved power supply.

- Cradles
 

Insert the device into a cradle. See [Chapter 13, Accessories](#) for accessory setup. The device starts to charge automatically. The charge LED on the device flashes during charging and goes off when the battery is fully charged (default). See [Table 13-2](#) for charging indications.
- Cables
 

Connect a charge cable to the appropriate power source and connect the other end of the charge cable to the device. See [Chapter 13, Accessories](#) for accessory setup. The device starts to charge automatically. The charge LED on the device flashes during charging and goes off when the battery is fully charged (default). See [Table 13-2](#) for charging indications.

See [Table 3-2 on page 3-3](#) for detailed scanning LED descriptions.

## Battery Safety



**IMPORTANT** Battery safety depends on the proper selection and care of batteries.

### Security Implementation/Protection From Counterfeit Batteries

Zebra devices are designed to work only with Zebra batteries. If you see a battery fault indication on the device display, take the following steps:

- Remove the battery and inspect it to confirm that it bears the Zebra name and/or logo.
- If there is no Zebra name and/or logo, the battery is not a qualified battery.
- If there is a Zebra name and/or logo, replace the battery and retry charging it.
- If the message remains, contact a Zebra service center.

### Zebra Battery Safety Recommendations For Users



**IMPORTANT** Handle and store batteries properly to avoid injury or damage.

Most battery issues arise from improper handling of batteries and particularly from the continued use of damaged batteries.

- Do not disassemble, crush, puncture, shred or otherwise attempt to change the form of the battery.
- Do not let the device or battery come in contact with water. Water can get into the circuits, leading to corrosion. If the device and/or battery get wet, have them checked by your administrator or contact Zebra even if they appear to be working properly.
- Do not allow the battery to touch metal objects. If metal objects stay in prolonged contact with the battery contact points, the battery could become very hot.
- Do not place the battery near a heat source. Excessive heat can damage the device or the battery. High temperatures can cause the battery to swell, leak or malfunction. Therefore:
  - Do not dry a wet or damp battery with an appliance or heat source, such as a hair dryer or microwave oven.
  - Avoid leaving the device in areas of high temperatures.
- Do not drop the battery or device. Dropping these items, especially on a hard surface, can potentially cause damage.
- Contact your service provider or Zebra if your device or battery was damaged from dropping or as a result of exposure to high temperatures.



**IMPORTANT** Use only Zebra-branded batteries and chargers.



**WARNING!** Use of a non-Zebra battery or charger may present a risk of fire, explosion, leakage or other hazard.

### Proper and Safe Battery Disposal & Recycling

Proper battery disposal is not only important for safety, it also benefits the environment. Promptly dispose of used batteries in accordance with local regulations. Contact your local recycling center or national recycling organizations for more information on how to dispose of batteries.

Additional information on proper disposal and recycling may be found on the Web at:

[www.zebra.com/recycling](http://www.zebra.com/recycling) and [www.rbr.org/call2recycle/](http://www.rbr.org/call2recycle/).

---

## Sending Data to the Host Computer

Out of the box, the device supports two modes to send data to a host computer: via cable (RS-232 or USB); and via Bluetooth (open/paired with an STB2078 cradle).

### Cable Mode

Via cable (RS-232 or USB) the user interface indicates the active mode for transmitting bar code data to the host.

- A **U** displays on the screen when bar code data transmits via USB.
- An **R** displays on the screen when bar code data transmits via RS-232.

### Bluetooth Mode

In Bluetooth mode (open or cradle), a Bluetooth icon displays on the screen when bar code data transmits via Bluetooth.

The cradle receives data from the device via a wireless radio connection and transmits it to the host computer via the host cable. The device and cradle must be paired for successful wireless communication.

### Pairing

Pairing registers a device to the cradle such that the device and cradle can exchange information. The cradles operate in two modes: Point-to-Point and Multipoint-to-Point. In Point-to-Point mode, pair the device to the cradle either by inserting it in the cradle (if pairing on insertion is enabled), or by scanning the pairing bar code. In Multipoint-to-Point mode, you can pair up to seven devices to one cradle. To use this feature, scan the multipoint bar code in [Multipoint-to-Point Communication on page 4-19](#).

The cradle includes pairing bar codes on both its front and back. To pair the device with the cradle, scan a pairing bar code. A high-low-high-low beep sequence followed by a low-high beep sequence indicates successful pairing and connection to the remote device. A long low, long high beep sequence indicates unsuccessful pairing.

- ✓ **NOTE** The pairing bar code that connects the device to a cradle is unique to each cradle. Do not scan data or parameters until pairing completes.

### Lost Connection to Host

If scanned data does not transmit to the cradle's host, ensure that all cables are firmly inserted and the power supply is connected to an appropriate AC outlet, if applicable. If scanned data still does not transmit to the host, reestablish a connection with the host:

1. Disconnect the power supply from the cradle.
2. Disconnect the host interface cable from the cradle.
3. Wait three seconds.
4. Reconnect the host interface cable to the cradle.
5. Reconnect the power supply to the cradle, if the host requires.
6. Reestablish pairing with the cradle by scanning the pairing bar code.

---

## Radio Communications

The device can communicate with remote devices via Bluetooth Technology Profile Support, or by pairing with a cradle. For radio communication parameters, detailed information about operational modes, Bluetooth Technology Profile Support and pairing, see [Chapter 4, Radio Communications](#).



---

## Startup

When the device is powered on for the first time, it initializes. The splash screen appears for a short period of time. If the device does not power on, see [Resetting the Device on page 1-17](#).



**Figure 1-10** *Splash Screen*

---

## Suspending/Powering Off the Device

A suspend menu item is accessible from *Home* screen. On the *Home* screen, press *Menu > Suspend*.

---

## Resetting the Device

See [Resetting the MT20X0 on page 2-106](#).

---

## Turning the WLAN Radio On and Off

See [Enable/Disable Radio on page 2-92](#).

---

## Waking the Device

See [Waking the MT20X0 on page 2-107](#).

---

## Battery Removal

To remove the battery:

1. Press *Menu* > *Suspend* to turn off the screen and place the device in suspend mode.
2. With your thumb, press down on the indentation on the battery lock and drag it away from the battery.
3. Lift up the back of the battery and pull it out of the battery well.

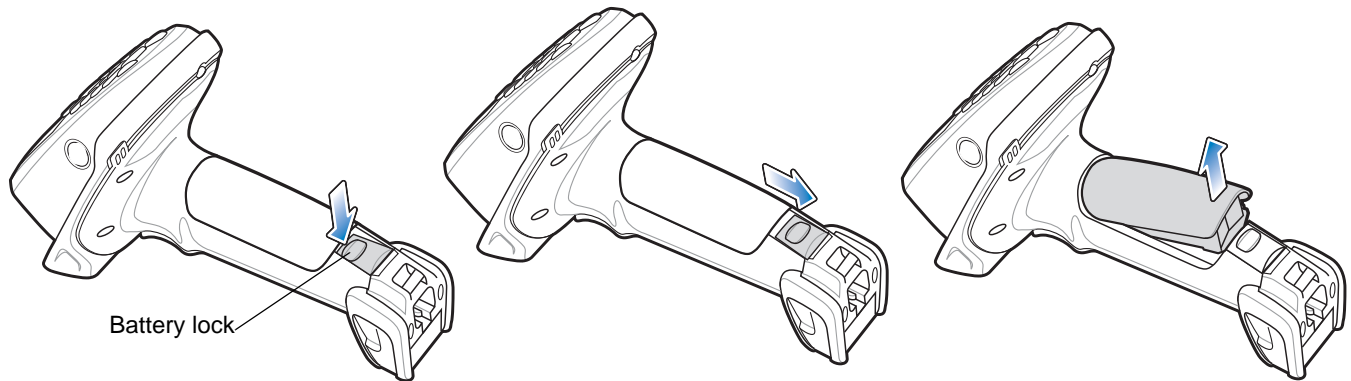

Figure 1-11 Li-ion Battery Removal



**WARNING!** The device is not water sealed when the battery is removed.

---

## Spare Battery Charging

Use the Spare Battery charger to charge spare Li-ion batteries. See to [Chapter 13, Accessories](#) for more information on spare battery charging.

---

## Screen Protector

For added protection from scratches the device includes a protective film over the display window. It is recommended you leave this on for added scratch resistance.

## Lanyard

To install the optional lanyard:

1. Insert the loop on the lanyard into the slot at the bottom of the device.

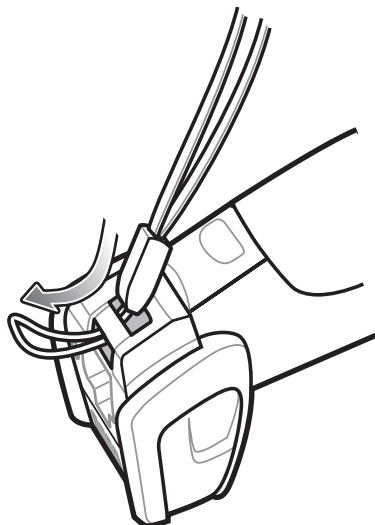

**Figure 1-12** *Insert Lanyard Loop*

2. Thread the upper portion of the lanyard into the loop.

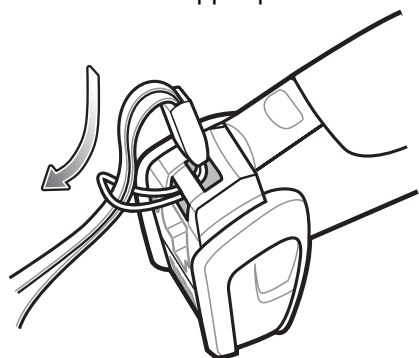

**Figure 1-13** *Thread the Loop*

3. Pull the clip through the loop over the tether point and tighten into place.

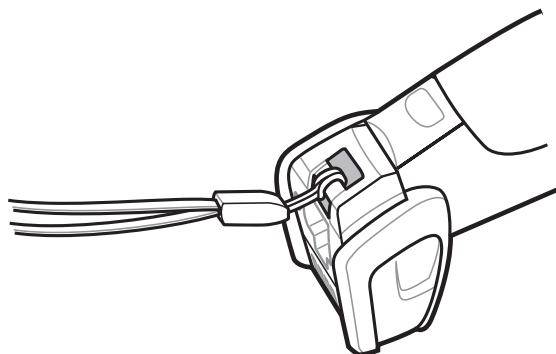

**Figure 1-14** *Insert Loop into Tether Point*



# Chapter 2 Operating the MT2070/MT2090

---

## Introduction

This chapter provides instructions for using and navigating the device.

## Keypad

The keypad contains alphanumeric characters, scroll keys, function keys and an *ENT* (Enter) key. The keypad is color-coded to indicate the alternate function keys (blue and orange). Note that an application can change the keypad functions so the device's keypad may not function exactly as described. See [Table 2-1 on page 2-3](#) for key descriptions.



**Figure 2-1** MT2070/MT2090 Keypad









**NOTE** The device does not have a *Power* key. To suspend the device go to *Home* screen; press the left soft key (*Menu*); scroll to *Suspend*; press *ENT*.

## Keypad Functionality



✓ **NOTE** The keypad functionality described in [Table 2-1](#) does not necessarily apply to all configurations of the MT20X0.

**Table 2-1** Keypad Functionality

Key	Description	Press Blue Key	Press Orange Key
Left Soft Key, ALT 	Defaults to the left soft key which initiates the action noted on the bottom left of the screen (usually a menu option); <i>ALT</i> key when the <b>Blue</b> function key is enabled.	ALT	N/A
Right Soft Key; CTRL 	Defaults to the right soft key which initiates the action noted on the bottom right of the screen; <i>CTRL</i> key when the <b>Blue</b> function key is enabled.	CTRL	N/A
Up, Down, Left, Right 	Defaults to <i>Scroll</i> key allowing up, down, left, right navigation.	N/A	N/A
Tab 	Defaults to <i>TAB</i> key; asterisk (*) when the <b>Blue</b> function key is enabled. Depending on the screen display, <i>TAB</i> moves from pane to pane in the contents section of a multipane display.	*	N/A
Backspace, ESC 	Defaults to backspace; <i>ESC</i> when the <b>Blue</b> function key is enabled. Depending on the screen display: Returns to the previous level in the display. Closes the menu and returns to the previous screen. Clears a highlighted field.	ESC	N/A
F1, 1, special characters 	Defaults to the number 1; F1 when the <b>Blue</b> function key is enabled; characters . , - when the <b>Orange</b> function key is enabled.	F1	. , -

\* See [Keypad Multi-tap Configuration on page 2-7](#).



Table 2-1 Keypad Functionality (Continued)

Key	Description	Press Blue Key	Press Orange Key
* F2, 2, A, B, C, a, b, c 	Defaults to the number 2; F2 when the <b>Blue</b> function key is enabled; A, B, C, a, b, c when the <b>Orange</b> function key is enabled. In alpha mode (enable <b>Orange</b> function key), the number of key presses determines the letter and case. 1 key press = a 2 key presses = b 3 key presses = c 4 key presses = A 5 key presses = B 6 key presses = C	F2	a, b, c, A, B, C
* F3, 3, D, E, F, d, e, f 	Defaults to the number 3; F3 when the <b>Blue</b> function key is enabled; D, E, F, d, e, f when the <b>Orange</b> function key is enabled. In alpha mode (enable <b>Orange</b> function key), the number of key presses determines the letter and case. 1 key press = d 2 key presses = e 3 key presses = f 4 key presses = D 5 key presses = E 6 key presses = F	F3	d, e, f, D, E, F
* F4, 4, G, H, I, g, h, i 	Defaults to the number 4; F4 when the <b>Blue</b> function key is enabled; G, H, I, g, h, i when the <b>Orange</b> function key is enabled. In alpha mode (enable <b>Orange</b> function key), the number of key presses determines the letter and case. 1 key press = g 2 key presses = h 3 key presses = i 4 key presses = G 5 key presses = H 6 key presses = I	F4	g, h, i, G, H, I

\* See [Keypad Multi-tap Configuration on page 2-7](#).





**Table 2-1 Keypad Functionality (Continued)**

Key	Description	Press Blue Key	Press Orange Key
<p>* F5, 5, J, K, L, j, k, l</p> 	<p>Defaults to the number 5; F5 when the <b>Blue</b> function key is enabled; J, K, L, j, k, l when the <b>Orange</b> function key is enabled.</p> <p>In alpha mode (enable <b>Orange</b> function key), the number of key presses determines the letter and case.</p> <p>1 key press = j                  2 key presses = k                  3 key presses = l                  4 key presses = J                  5 key presses = K                  6 key presses = L</p>	F5	j, k, l, J, K, L
<p>* F6, 6, M, N, O, m, n, o</p> 	<p>Defaults to the number 6; F6 when the <b>Blue</b> function key is enabled; M, N, O, m, n, o when the <b>Orange</b> function key is enabled.</p> <p>In alpha mode (enable <b>Orange</b> function key), the number of key presses determines the letter and case.</p> <p>1 key press = m                  2 key presses = n                  3 key presses = o                  4 key presses = M                  5 key presses = N                  6 key presses = O</p>	F6	m, n, o, M, N, O
<p>* F7, 7, P, Q, R, S, p, q, r, s</p> 	<p>Defaults to the number 7; F7 when the <b>Blue</b> function key is enabled; P, Q, R, S, p, q, r, s when the <b>Orange</b> function key is enabled.</p> <p>In alpha mode (enable <b>Orange</b> function key), the number of key presses determines the letter and case.</p> <p>1 key press = p                  2 key presses = q                  3 key presses = r                  3 key presses = s                  4 key presses = P                  5 key presses = Q                  6 key presses = R                  7 key presses = S</p>	F7	p, q, r, s, P, Q, R, S





\* See *Keypad Multi-tap Configuration* on page 2-7.

**Table 2-1 Keypad Functionality (Continued)**

Key	Description	Press Blue Key	Press Orange Key
* F8, 8, T, U, V, t, u, v 	Defaults to the number 8; F8 when the <b>Blue</b> function key is enabled; T, U, V, t, u, v when the <b>Orange</b> function key is enabled. In alpha mode (enable <b>Orange</b> function key), the number of key presses determines the letter and case. 1 key press = t 2 key presses = u 3 key presses = v 4 key presses = T 5 key presses = U 6 key presses = V	F8	t, u, v, T, U, V
* F9, 9, W, X, Y, Z, w, x, y, z 	Defaults to the number 9; F9 when the <b>Blue</b> function key is enabled; W, X, Y, Z, w, x, y, z when the <b>Orange</b> function key is enabled. In alpha mode (enable <b>Orange</b> function key), the number of key presses determines the letter and case. 1 key press = w 2 key presses = x 3 key presses = y 4 key presses = W 5 key presses = X 6 key presses = Y	F9	w, x, v, z, W, X, V, Z
Home, 0, space 	Defaults to the number 0; Displays the <i>Home</i> screen when the <b>Blue</b> function key is enabled; space when the <b>Orange</b> function key is enabled. The <i>Home</i> key returns to the <i>Home</i> screen. The space ( — ) can be used to: <ul style="list-style-type: none"> <li>• select/clear check boxes</li> <li>• select an item.</li> </ul>	Home <b>Note:</b> Under most circumstances pressing the <i>Home</i> key brings the Navigator application to the foreground. However, <i>Home</i> key functionality depends upon the current screen display.  This key cannot be programmed.	Space

\* See *Keypad Multi-tap Configuration on page 2-7.*

**Table 2-1** Keypad Functionality (Continued)

Key	Description	Press Blue Key	Press Orange Key
ENT 	Press <i>ENT</i> ( <i>Enter</i> ) to launch an application or select a current/highlighted item. Depending on the screen, press <i>Enter</i> to: <ul style="list-style-type: none"> <li>• close a display and return to the previous screen.</li> <li>• lock in an entered quantity and highlight an item field.</li> <li>• store data from an item field.</li> <li>• to edit a highlighted item.</li> </ul>	N/A	N/A
Orange 	Press this key once to enable the orange alpha and special character keys. Press the key again to disable alpha and special character keys and return to default key use.  When enabled, a filled orange circle  displays (see <a href="#">Screen Icons on page 2-9</a> ). When no circle displays, orange key functionality is disabled.	N/A	N/A
Blue 	Press this key once to enable functionality of <i>ALT</i> , <i>CTRL</i> , <i>*</i> , <i>ESC</i> or a function key. When enabled, an empty blue circle  displays (see <a href="#">Screen Icons on page 2-9</a> ). When no circle displays, blue key functionality is disabled.	N/A	N/A

\* See [Keypad Multi-tap Configuration on page 2-7](#).

### Keypad Multi-tap Configuration

In alpha mode (when the **Orange** function key is enabled/tapped) the default sequence of multi-tapping a key is lower case first. For example, multi-taps of the 2 key displays 'a', 'b', 'c', 'A', 'B', 'C', lower case first.

The multi-tap sequence can be changed by modifying the Multitap.reg file under the "\Platform" directory on the device.

For detailed information, refer to the MT2070/MT2090 Integrator Guide, p/n 72E-117858-xx.

---

## Using the Keypad to Navigate Applications

The screen is a non-touch screen. Navigation and control of an application is performed using the keypad.

---

## Entering Information

To enter information:

- Use the keypad.
- Scan bar code data into data fields.
- Use Microsoft® ActiveSync® to synchronize or copy information from the host computer to the device. For more information on ActiveSync, refer to the *MT2070/MT2090 Integrator Guide* (part number 72E-117858-xx).

### Entering Information Using the Keypad

The alphanumeric keypads produce the 26-character alphabet (A-Z), numbers (0-9), function keys and assorted characters. The keypads' default characters/functions are printed white, the alpha character/functions are printed orange and the function character/functions are printed blue. See [Keypad on page 2-2](#) for keypad configurations.

# Screen Icons

Table 2-2 Icons

























Icon	Description
<b>Battery</b>	
	Critical low battery (< 5% full); recharge.
	Battery fault.
	Battery fault; AC power applied. Low battery; recharge.
	Low battery; recharge.
	Battery is 25% full.
	Battery is 50% full.
	Battery is 75% full.
	Battery is fully charged.
	Low battery; charging using AC power source.
	Battery 25% full; charging using AC power source.
	Battery 50% full; charging using AC power source.
	Battery 75% full; charging using AC power source.
	Battery is fully charged; AC power source connected.

Table 2-2 Icons (Continued)

Icon	Description
<b>Connections</b>	
	Bluetooth is inactive (STB2078 cradle only).
	Bluetooth is active (STB2078 cradle only).
	RS-232 connection is active.
	USB connection is active.
<b>Keypad Functionality</b>	
	One time blue key functionality (see <a href="#">Blue on page 2-7</a> ).
	Unlimited orange key functionality (see <a href="#">Orange on page 2-7</a> ).
<b>Wireless Signals (MT2090 Only)</b>	
	No wireless signal or not associated.
	Very low signal.
	Low signal. Medium signal.
	Medium signal.
	Good signal.
	Excellent signal.

## Home Screen

When the device powers on, the first screen to display is the *Home* screen. This screen also launches when you press the *Home* key (see *Home, 0, space* on [page 2-6](#)).

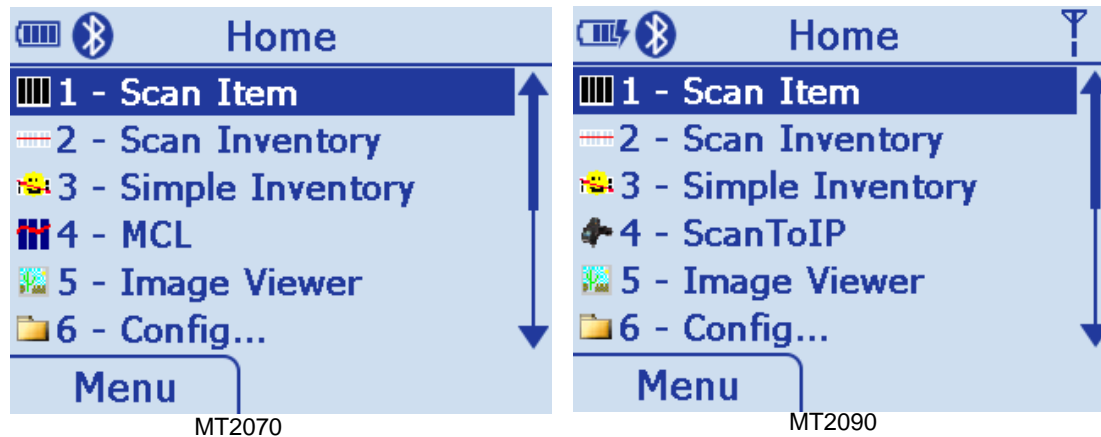

**Figure 2-2** Home Screen

[Table 2-3](#) lists the options available on the *Home* screen. Use the Up or Down *Scroll* key to highlight an option in the list and press *ENT* to launch the screen.

**Table 2-3** Home Screen Options

Option	Description
Scan Item	On this screen the user can, scan, display and transmit bar code data. See <a href="#">page 2-17</a> .
Scan Inventory	On this screen the user can enter inventory information and send it to a local file in the Windows CE file system. See <a href="#">page 2-20</a> .
Simple Inventory	This is a batch inventory application similar to <i>Scan Inventory</i> . It differs in that it transmits data into the MT as scanned. For example, it does not alphabetize or group same bar codes. See <a href="#">page 2-26</a> .
ScanToIP	The Scan-to-IP application allows you to scan directly to a host PC using your existing WiFi network. The application is pre loaded on newer MT2090 devices and can be downloaded from the Web to older models. See <a href="#">page 2-32</a> .
MCL (MT2070 Only)	The MCL application on the device is a simple scanning application which performs scanning and sending bar codes to a host computer. See <a href="#">page 2-35</a> .
Image Viewer	On this screen the user can preview, snap and save images. See <a href="#">page 2-39</a> .

**Table 2-3** Home Screen Options (Continued)

Option	Description
Config...	On this screen the user has access to the following features: <ul style="list-style-type: none"> <li>• Wireless Companion - see <a href="#">page 2-41</a>.</li> <li>• Settings - see <a href="#">page 2-93</a>.</li> <li>• Rapid Deployment - see <a href="#">page 2-93</a>.</li> <li>• MSP Agent - see <a href="#">page 2-94</a>.</li> <li>• BTExplorer - see <a href="#">page 2-95</a>.</li> <li>• Configure USB - see <a href="#">page 2-102</a>.</li> </ul>
Utilities...	On this screen the user has access to the following features: <ul style="list-style-type: none"> <li>• File Explorer</li> <li>• Task Manager.</li> </ul> See <a href="#">page 2-104</a> .
Menu	This menu provides access to <i>User Settings</i> , <i>Device Status</i> , <i>Battery Status</i> and an <i>About</i> screen. See <a href="#">page 2-13</a> .

## Menu

The Home screen Menu provides access to *User Settings*, *Device Status*, *Battery Status* and an *About* screen. Press the Up or Down Scroll key to select an option. Press *ENT* to display the appropriate screen.

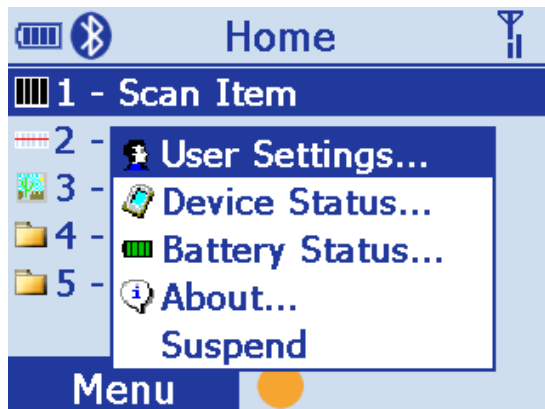
**Figure 2-3** Home Screen Menu



## User Settings

On this screen, make adjustments for the device's beeper, backlight and time. Press the Up or Down *Scroll* key to select an option.

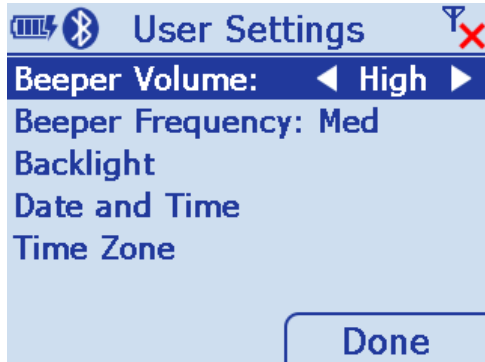

Figure 2-4 User Settings Screen

- **Beeper Volume:** Scroll to *Beeper Volume* and press the right or left *Scroll* key to choose a Low, Medium or High beeper volume. Press the right soft key (*Done*) to save changes and end the session.
- **Beeper Frequency:** Scroll to *Beeper Frequency* and press the right or left *Scroll* key to choose a Low, Medium or High beeper frequency. Press the right soft key (*Done*) to save changes and end the session.
- **Backlight:** Scroll to *Backlight* and press *ENT* to display the *Backlight* screen.



Figure 2-5 Backlight Screen

Scroll to the appropriate line.

- **Brightness:** Use the right or left *Scroll* key to choose a brightness level for the display.
- **Battery Timeout:** Using the keypad, enter a numeric value to set the seconds in which the backlight turns off when the device is exclusively using battery power.
- **AC Timeout:** Using the keypad, enter a numeric value to set the seconds in which the backlight turns off when the device is not powered exclusively by battery power.
- Press the right soft key (*Done*) to save changes and end the session.

- Date and Time: With *Date* and *Time* highlighted, press *ENT* to display the *Date and Time* screen.



**Figure 2-6** *Date and Time* Screen

- Press *TAB* to toggle between *Date:* and *Time:* fields.
- Press the right or left *Scroll* key to move to sub-fields within *Date:* and *Time:*.
- Press the Up or Down *Scroll* key to change values.

Press the right soft key (*OK*) to save changes and end the session.

Press the left soft key (*Cancel*) to end the session without saving changes.

- Time Zone: With *Time Zone* highlighted, press *ENT* to display the *Time Zone* screen.

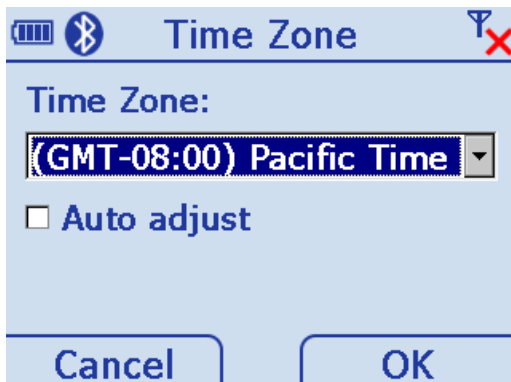

**Figure 2-7** *Time Zone* Screen

- Press *TAB* to toggle between *Time Zone:* and *Auto adjust* fields.
- Press the Up or Down *Scroll* key to change the time zone.
- Press the *Space* key (see *Space* key on [page 2-6](#)) to check/uncheck the *Auto adjust* box. Press the right soft key (*OK*) to save changes and end the session.

Press the left soft key (*Cancel*) to end the session without saving changes.

### Device Status

This screen displays information about the device: model, serial number, Bluetooth, MAC address and ADCSvcs version.

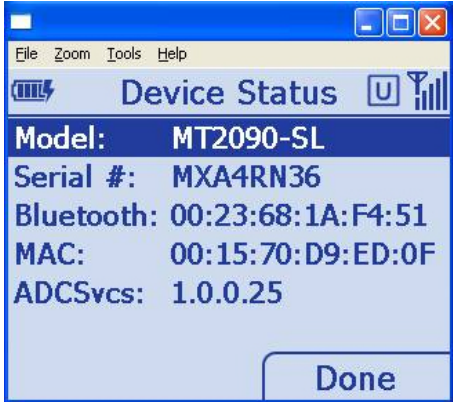

Figure 2-8 Device Status Screen

✓ **NOTE** MAC: field applies to the MT2090 only.

### Battery Status

This screen displays the device's battery information.



Figure 2-9 Battery Status Screen

## About

This screen displays version and copyright information.

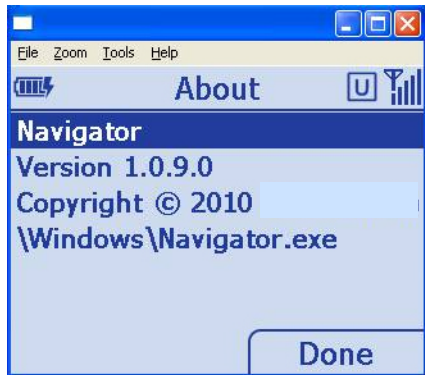

**Figure 2-10** About Screen

## Suspend

On the *Home* screen (see [Figure 2-2 on page 2-11](#)) press *Menu* > *Suspend* to place the device in sleep mode. To wake the device, press any key.

## Scan Item

The *Scan Item* screen allows the user to transmit bar code data to the host PC. To access *Scan Item*, start at the *Home* screen, scroll to *Scan Item* and press *ENT*.

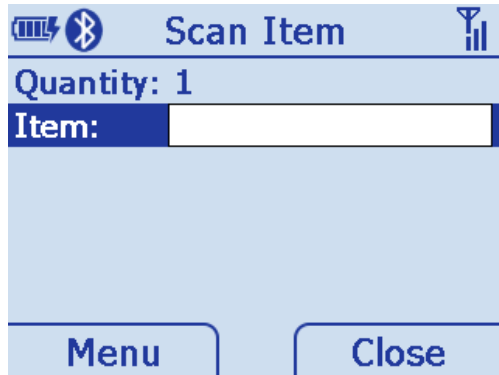

**Figure 2-11** *Scan Item* Screen

The following options are available:

- Scan a bar code. The data displays briefly in the *Item:* field and the bar code data transmits to the host PC (Quantity defaults to a value of one and transmits one bar code.)
- Key an SKU or bar code data manually using the keyboard. Press *ENT* to transmit the data to the host PC. (Quantity defaults to a value of one and transmits one SKU or bar code.)
- Press the up *Scroll* key to access the *Quantity* field; enter a quantity using the keyboard. Scan a bar code (or enter an SKU/bar code manually and press *ENT*). The data transmits x times, where x = the quantity entered, with a programmable delay between each transmit.
- Select *Menu > Options...* to set the transmit format (see [Menu on page 2-18](#)).

### Quantity

Enter the quantity of SKUs or bar code data to transmit to the host PC (1 to 99999). Quantity defaults to a value of one and transmits one bar code.

### Item

The *Item:* field is highlighted by default. Scan a bar code or use the numeric keys to manually enter an SKU or bar code. The default symbology type is Code 128.

## Menu

Press the left soft key to display the *Menu*.

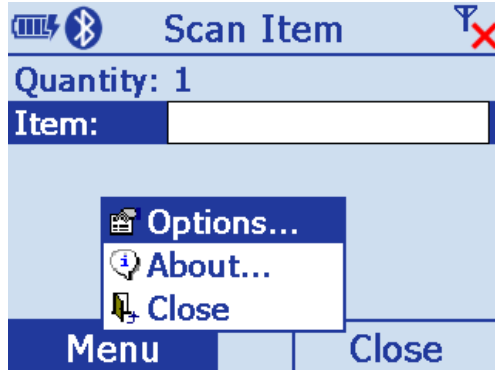

Figure 2-12 Scan Item Screen - Menu

## Options

Scroll to Options... and press *ENT* to display the options screen to set transmit bar code data options.

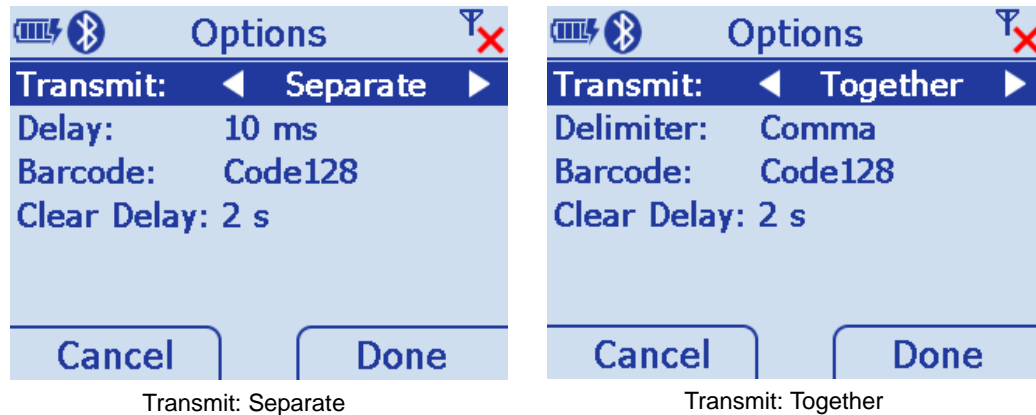

Figure 2-13 Scan Item Screen - Menu - Options

- **Transmit:** When you enter a quantity of two or more on the *Scan Item* screen, scroll to *Transmit:* in this display and press the left or right scroll key to select how to transmit bar code data - *Together* or *Separate*.
- **Delimiter:** When you select to transmit bar code data *Together*, the *Delimiter:* field displays. Scroll to this field and press the left or right scroll key to choose a delimiter method - *comma*, *semi-colon* or *tab*.
- **Delay:** When you select to transmit *Separate* bar code data, scroll to *Delay:* and enter the time in milliseconds to separate the transmission of data.
- **Barcode:** Scroll to *Barcode:* to choose a symbology type - *Code 128* or *Code 39*.
- **Clear Delay:** The number of seconds a bar code clears after transmission.
- **Cancel:** Press to cancel settings and return to previous screen.
- **Done:** Press to save settings and return to previous screen.

**About...**

Displays information about the ScanItem application.

**Close**

Press the right soft key to close the screen and return *Home*.

**Close**

Scroll to **Close** and press *ENT* to exit and return *Home*.

## Scan Inventory

The *Scan Inventory* screen allows the user to enter inventory information and send it to a local file in the Windows CE file system. Set the file type in which to save the inventory data in *Menu > Options* screen > *Format*: (see [Figure 2-16 on page 2-21](#)).

To access *Scan Inventory*, start at the *Home* screen, scroll to *Scan Inventory* and press *ENT*.

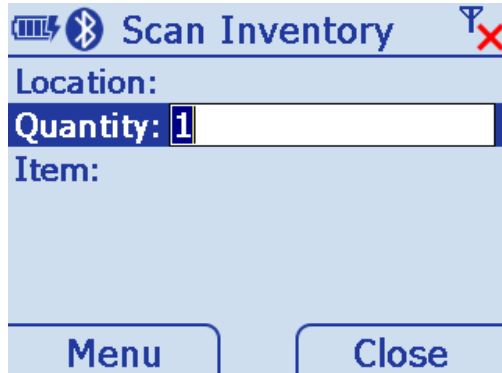

**Figure 2-14** *Scan Inventory* Screen - Default View

When the *Scan Inventory* screen displays for the first time, the cursor defaults to the *Quantity* field. If a quantity is required, it must be entered prior to scanning or entering data in the *Item*: field. Use the Up or Down *Scroll* key to move from one field to another. Enter data as necessary.

### Location

Use the keypad to enter a location. Location is an eight character alphanumeric field. Press the orange key to enable the alpha keypad; press the orange key again to enable the numeric keypad. When the alpha keypad is enabled and orange circle appears on the bottom of the screen.



**Figure 2-15** *Scan Inventory* Screen - Location

The device remembers the location entered throughout the session, until it is changed and stores as the default location in *location.xml*.



## Quantity

Quantity defaults to a value of one to transmit one bar code to the host PC.

Scroll to Quantity and use the keypad to enter the quantity of SKUs or bar code data to transmit to the host PC (1 to 99999).



**IMPORTANT** Quantity must be entered prior to scanning or entering data in the *Item:* field.

## Item

Scroll to Item and scan a bar code or use the keypad to enter an SKU or bar code to transmit to the host PC. The data displays on the screen for 3 seconds or less with a trigger or key press. The default symbology type is Code 128.

## Menu

Press the left soft key to display the *Menu*.

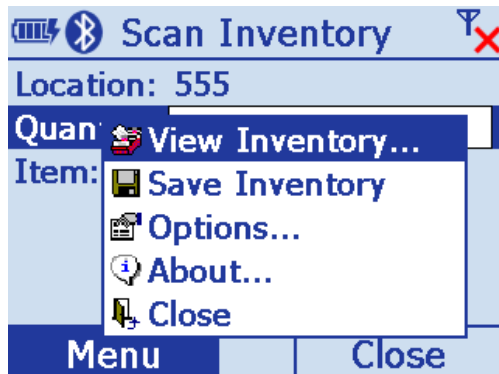

**Figure 2-16** Scan Inventory Screen - Menu

## View Inventory

Scroll to *View Inventory* and press *ENT* to display a list of the saved inventory items stored in the device. Each row in the list includes location, quantity and bar code/SKU.

The current inventory stores in a .txt or .xml file located in the Applications/Inventory folder. If no inventory items were saved, the file does not exist and no contents display. If the file does exist, the items display in a list view with column headers for location, item and quantity.

The *View Inventory* screen has several menu options for maintaining information saved in the inventory file.

### View Inventory Menu

The *View Inventory* menu includes several options to maintain and customize inventory data. On the *View Inventory* screen press the left soft key to display the menu items. Press the Up or Down *Scroll* key to select an option. Press *ENT* to display the appropriate screen.

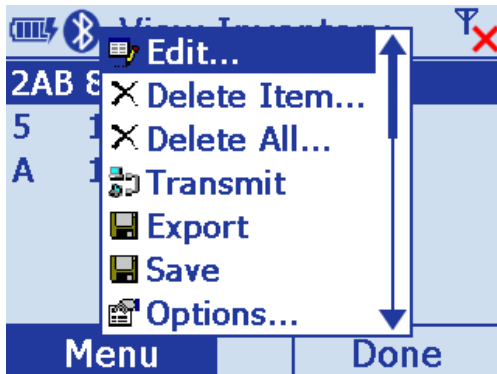

Figure 2-17 View Inventory Menu

- Edit

Ensure the item to edit is highlighted on the *View Inventory* screen, then press *Menu > Edit*. On the *Edit Item* screen (Figure 2-18) edit the inventory data as needed (scanning is disabled in this view and data must be edited manually). Press *TAB* to move from field to field. Use the keypad to edit the information in each field.

✓ **NOTE** By default the orange key is not active in the *Edit Item* window. If necessary, press the orange key to enable/disable the alpha key pad.

Press the left soft key (Cancel) to cancel the edits and return to the *View Inventory* screen. Press the right soft key (OK) to save the edits.

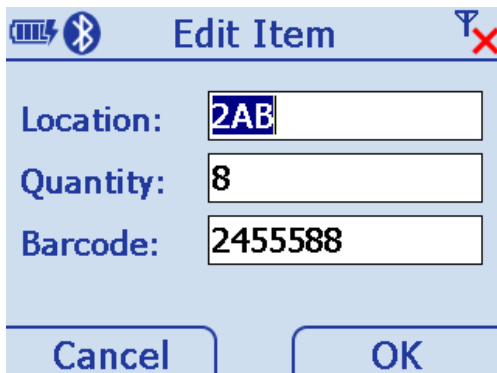
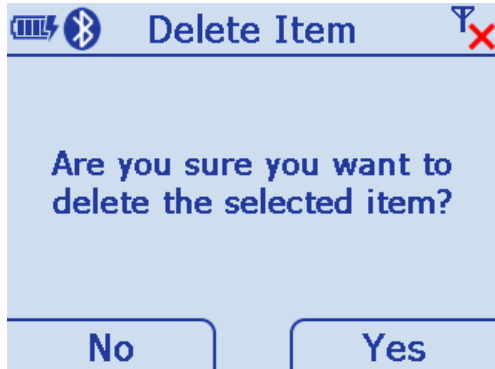

Figure 2-18 Edit Item Screen

- Delete Item

Ensure the item to delete is highlighted on the *View Inventory* screen, then press *Menu > Delete Item...* . The following confirmation dialog displays. Press the left soft key (*No*) to cancel the delete and return to the *View Inventory* screen. Press the right soft key (*Yes*) to delete the selected inventory item.



**Figure 2-19** *Delete Item Dialog*

- Delete All

On the *View Inventory* screen, press *Menu > Delete All...* . The following confirmation dialog displays. Press the left soft key (*No*) to cancel the delete and return to the *View Inventory* screen. Press the right soft key (*Yes*) to delete all inventory items listed.

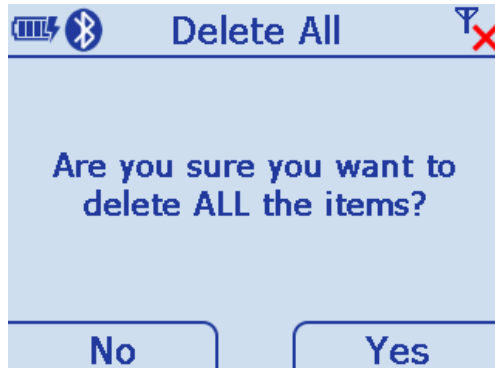

**Figure 2-20** *Delete All Dialog*

- Transmit

Selecting *Transmit* sends data to the host PC via the configured interface and protocol (such as USB HID keyboard).

On the *View Inventory* screen, press *Menu > Transmit* to send data.



**NOTE** Data is not deleted after transmission.

- Export

Exporting formats data in a user friendly layout which can be downloaded from the device. On the *View Inventory* screen, press *Menu > Export*. The dialog in [Figure 2-21](#) displays indicating the path of the file to be exported to the Application folder on the device. The default file name and type is *export.txt*. Press *ENT* to export all data and return to the *View Inventory* screen.



**Figure 2-21** *Export Dialog*

✓ **NOTE** The export format, text or XML, is specified in [Options... on page 2-25](#).

- Save

Saving data ensures that data is not lost during a warm or cold boot. For example, when the user inserts a new battery in the device, a save is recommended prior to switching batteries. On the *View Inventory* screen, press *Menu > Save*. The following dialog displays indicating a successful save. Press *ENT* to accept the save and return to the *View Inventory* screen.



**Figure 2-22** *Save Dialog*

- Options

On the *View Inventory* screen, press *Menu > Options*.

### **Save Inventory**

Scroll to *Save* and press *ENT* to save the data to the location specified in the *Options* dialog.

**Options...**

Scroll to *Options* and press *ENT* to configure the inventory application. On this screen, set the file format and the file storage location to save data. The format is specified in an xml file located in the folder *lapplication\inventory*.

Press the Up or Down *Scroll* key to move from field to field. Use the keypad to enter a value in the *File:* field; Press the right or left *Scroll* key to change the data within all other fields.



**Figure 2-23** Options Screen

- File: Specify a file type.
- Format: Specify a Text or XML file format.
- Separator: Specify a delimiter (comma, semi-colon or tab).
- Grouped: Currently not implemented.
- Clear Delay: The time in seconds data is automatically cleared from the display after scanning.
- Cancel: Press to cancel settings and return to previous screen.
- Done: Press to save settings and return to previous screen.

**About...**

Displays information about the *ScanInventory* application.

**Close**

Scroll to *Close* and press *ENT* to exit and return *Home*.

## Simple Inventory

Similar to *Scan Inventory*, the *Simple Inventory* screen allows the user to enter and transmit inventory information. It differs from *Scan Inventory* in that it transmits data the same way the data is scanned into the MT. For example, if the user scans bar codes 123, 456, ABC, 123, 012, ABC in this order, the application transmits the bar codes to the host in the same order:

123  
456  
ABC  
789  
123  
012  
ABC

Same data is not grouped or alphabetized.

To access *Simple Inventory*, start at the *Home* screen, scroll to *Simple Inventory* and press *ENT*.



Figure 2-24 *Simple Inventory* Screen - Default View

### Item

When the *Simple Inventory* screen displays for the first time, the cursor defaults to the *Item:* field. Scan a bar code or use the keypad to enter an SKU or bar code to transmit to the host PC. The default symbology type is Code 128.

### Quantity

If a quantity is required, it must be entered prior to scanning or entering data in the *Item:* field. Use the Up or Down *Scroll* key to move from one field to another. Enter data as necessary.

Quantity defaults to a value of one to transmit one bar code to the host PC.

Scroll to *Quantity* and use the keypad to enter the quantity of SKUs or bar code data to transmit to the host PC (1 to 99999).



**IMPORTANT** Quantity must be entered prior to scanning or entering data in the *Item:* field.

## Menu

Press the left soft key to display the *Menu*.

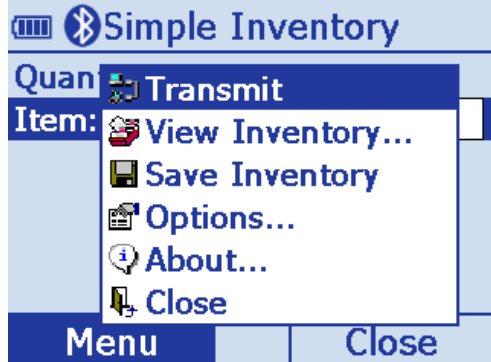

Figure 2-25 Simple Inventory Screen - Menu

### Transmit

Selecting *Transmit* sends data to the host PC via the configured interface and protocol (such as USB HID keyboard).

On the *Simple Inventory* screen, press *Menu* > *Transmit* > *ENT* to send data.

✓ **NOTE** Data is not deleted after transmission.

### View Inventory

Scroll to *View Inventory* and press *ENT* to display a list of the saved inventory items stored in the device. Each row in the list includes location, quantity and bar code/SKU.

The current inventory stores in a .txt or .xml file located in the Applications/Inventory folder. If no inventory items were saved, the file does not exist and no contents display. If the file does exist, the items display in a list view with column headers for location, item and quantity.

The *View Inventory* screen has several menu options for maintaining information saved in the inventory file.

### View Inventory Menu

The *View Inventory* menu includes several options to maintain and customize inventory data. On the *View Inventory* screen press the left soft key to display the menu items. Press the Up or Down *Scroll* key to select an option. Press *ENT* to display the appropriate screen.

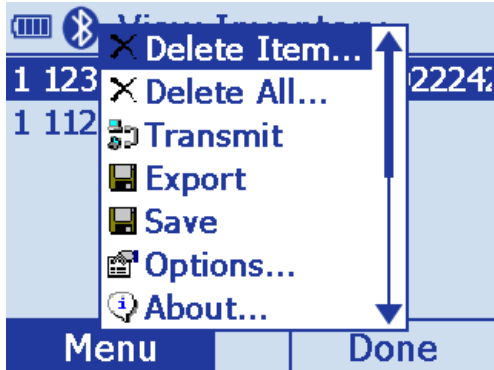

Figure 2-26 *View Inventory Menu*

- Delete Item

Ensure the item to delete is highlighted on the *View Inventory* screen, then press *Menu > Delete Item...* . The following confirmation dialog displays. Press the left soft key (*No*) to cancel the delete and return to the *View Inventory* screen. Press the right soft key (*Yes*) to delete the selected inventory item.

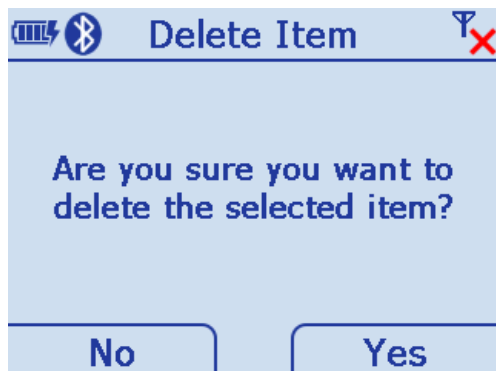

Figure 2-27 *Delete Item Dialog*



- Delete All

On the *View Inventory* screen, press *Menu > Delete All...* . The following confirmation dialog displays. Press the left soft key (*No*) to cancel the delete and return to the *View Inventory* screen. Press the right soft key (*Yes*) to delete all inventory items listed.

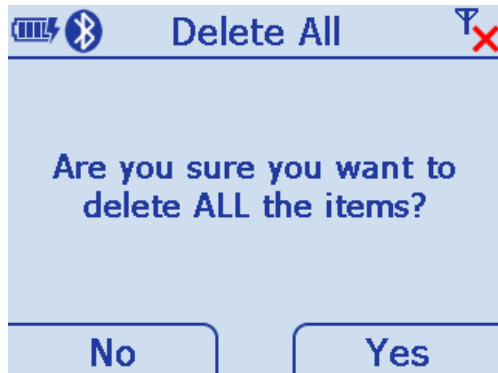

Figure 2-28 *Delete All Dialog*

- Transmit

Selecting *Transmit* sends data to the host PC via the configured interface and protocol (such as USB HID keyboard).

On the *Simple Inventory* screen, press *Menu > Transmit > ENT* to send data.

✓ **NOTE** Data is not deleted after transmission.

- Export

Exporting formats data in a user friendly layout which can be downloaded from the device. On the *View Inventory* screen, press *Menu > Export*. The dialog in [Figure 2-21](#) displays indicating the path of the file to be exported to the Application folder on the device. The default file name and type is *export.txt*. Press *ENT* to export all data and return to the *View Inventory* screen.



Figure 2-29 *Export Dialog*

✓ **NOTE** The export format, text or XML, is specified in [Options... on page 2-25](#).

- Save

Saving data ensures that data is not lost during a warm or cold boot. For example, when the user inserts a new battery in the device, a save is recommended prior to switching batteries. On the *View Inventory* screen,

press *Menu* > *Save*. The following dialog displays indicating a successful save. Press *ENT* to accept the save and return to the *View Inventory* screen.



Figure 2-30 Save Dialog

- Options  
On the *View Inventory* screen, press *Menu* > *Options*.

### Save Inventory

Scroll to *Save* and press *ENT* to save the data to the location specified in the *Options* dialog.

### Options...

Scroll to *Options* and press *ENT* to configure the inventory application. On this screen, set the file format and the file storage location to save data. The format is specified in an xml file located in the folder *application\inventory*.

Press the Up or Down *Scroll* key to move from field to field. Use the keypad to enter a value in the *File:* field; Press the right or left *Scroll* key to change the data within all other fields.

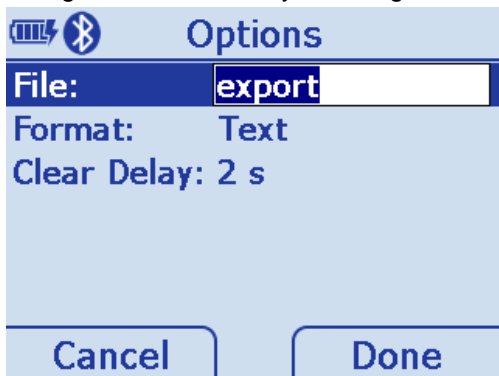

Figure 2-31 Options Screen

- File: Specify a file type.
- Format: Specify a Text or XML file format.
- Clear Delay: The time in seconds data is automatically cleared from the display after scanning.
- Cancel: Press to cancel settings and return to previous screen.
- Done: Press to save settings and return to previous screen.

***About...***

Displays information about the *ScanInventory* application.

***Close***

Scroll to Close and press *ENT* to exit and return *Home*.

## Scan-To-IP

The Scan-to-IP screen allows the user to scan directly to a host PC using your existing wireless network. The application should be pre loaded on the MT2090 device.

- ✓ **NOTE** Scan-to-IP may not be loaded on older devices. In this case, download the application to your PC; establish an ActiveSync connection; run ScanToIpDeviceInstaller.exe to download it to the MT2090.

The host application must be installed on your PC or terminal host.

### Setup

- Install the host application on your PC or terminal host. Visit <http://www.scan-to-ip.com> to download both the Windows host application and the device installer, if necessary.
- Run the host application, *ScanToIp.exe*, from the Scan-to-IP folder on the PC or terminal host.
- To access *Scan-To-IP*, start at the *Home* screen, scroll to *Scan-To-IP* and press *ENT*.



Figure 2-32 Scan-To-IP Option on Home Screen

- Click the *Setup* tab. Press the right soft key to display the *Setup*.

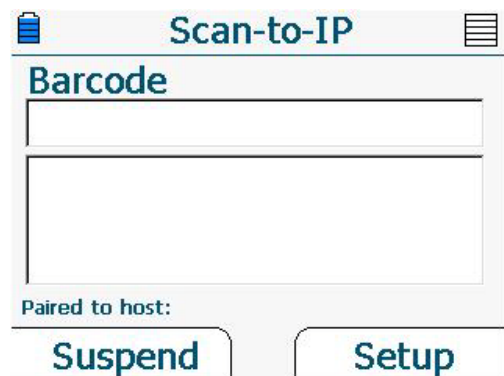

Figure 2-33 Scan-To-IP Screen

- Enter the *Host* (IP) address, or keep the default setting.
- Press TAB to Enter the *Host port no.*, or keep the default setting.

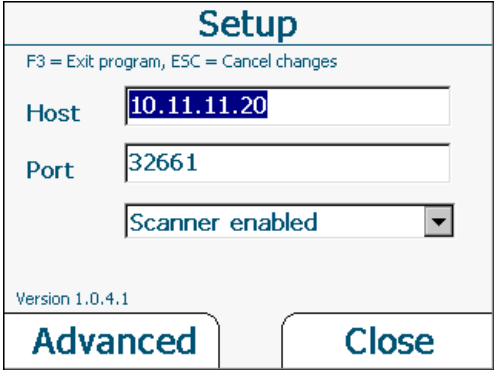

Figure 2-34 Terminal Host Setup Screen

- Click **Create pairing barcode** and print the bar code (imager units can scan the monitor).

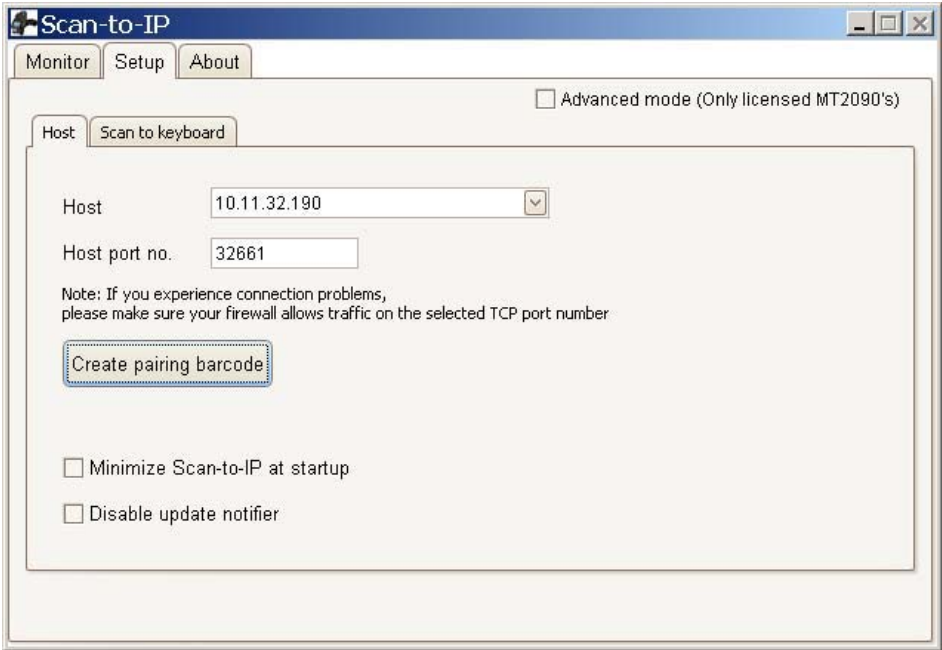

Figure 2-35 Host Application - PC Setup Screen

- Scan the bar code to pair with the host PC/server (print and scan the bar code or for imager units, scan the bar code directly on the monitor).

## Scan-to-IP

Scan barcode to pair with host PC/server

Host: 10.11.32.190

Port: 32661



**Figure 2-36** *Scan-to-IP Pair Bar Code*

- The host application and the MT2090 device should now be paired.

The device installer can also be used to:

- Configure the WLAN settings
- Configure scanner settings
- Buy and activate an advanced license for additional features.

If you have problems or questions, select *FAQ* at <http://www.scan-to-ip.com>.

## Suspend

Press the left soft key to suspend the device. (Press any key to wake the suspended device.)

## MCL

When you select MCL from the *Home* screen, the MCL-Client loads and the MCL program which loaded on the device runs.



**Figure 2-37** *MCL-Client Load - Typical View*

By default, the MCL application on the device is a simple scanning application which performs scanning and sending bar codes to a host computer, and scanning inventory with a timestamp.

✓ **NOTE** The MCL client is pre-licensed on the MT2070 only. The MCL client on the MT2090 requires an activated license to run.

MCL-Collection is an intuitive, high-productivity software tool used to create, integrate and deploy enterprise, multimodal mobile worker applications quickly and easily. From bar code scanning and data capture on devices to ODBC, WMS, or SAP R/3 connectivity on the host, MCL-Collection provides seamless integration from the computer to host application.

For more information refer to the *MCL Technologies Start Up Guide for the MT2000* at: <http://www.mcl-collection.com>.

When the MCL-Client loads, the *Main Menu* screen of the default MCL program loads. On this screen, select the mode (*Scan Transmit* on page 2-36 or *Scan Inventory* on page 2-37) of the MCL default scanning application.

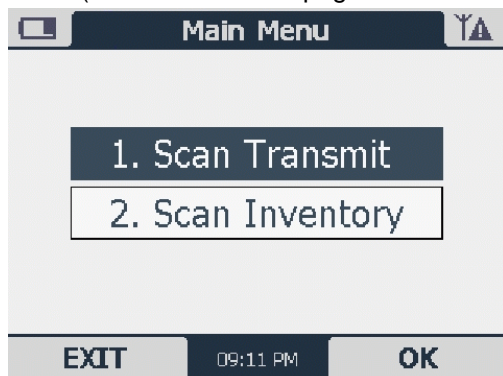



**Figure 2-38** *MT2000 Default Application Home Screen - Typical View*

## Scan Transmit

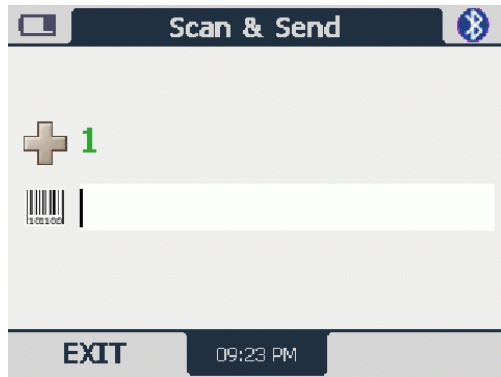
When *Scan Transmit* is selected on the *Main Menu*, the *Scan & Send* screen displays. On this screen the user can manually enter a quantity and scan data to a computer using a tethered cable or a Bluetooth connection via the STB2078 cradle.



**Figure 2-39** *Scan & Send Screen*

-  : Use the keypad to enter a quantity into this field. Scanning is disabled when this field is highlighted.
  -  : Scan a bar code to enter data into this field. After scanning data, the quantity and data are sent to MCL Link.
- ✓ **NOTE** On the first transmit; the application establishes communication with MCL link which may take several seconds.



### Scan Inventory

When *Scan Inventory* is selected on the *Main Menu*, the *Scan Inventory* screen displays (*Figure 2-40*). On this screen the user must enter the location in which the inventory is scanned. When a location is not entered, two short beeps sound indicating an error.

1. Use the keypad to enter a location and press *ENT* to continue.

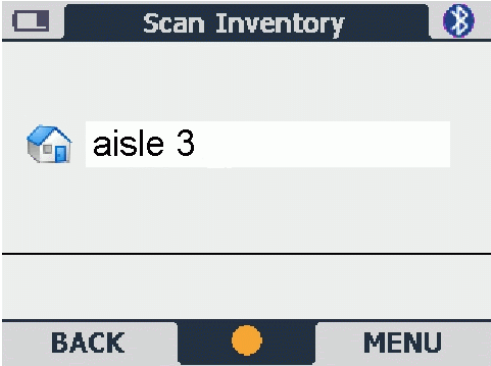

Figure 2-40 Scan Inventory Screen

2. Upon pressing *ENT*, the *Scan* screen displays.

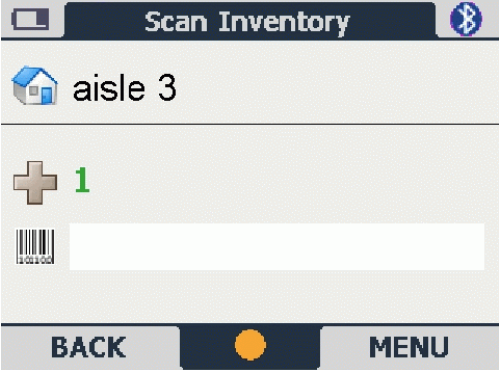



Figure 2-41 Scan Inventory Scan Screen

3.  : Use the keypad to enter a quantity into this field. Scanning is disabled when this field is highlighted.
4.  : Scan a bar code to enter data into this field. Scanned data in this screen is stored on the FFS file system and can be viewed, deleted, or transmitted to MCL Link.

5. Use the right soft key to select *MENU*. The *Inventory Menu* displays.

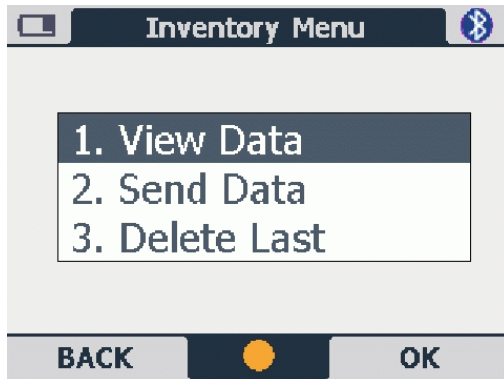

Figure 2-42 *Inventory Menu Screen*

6. Select the appropriate option and press the right soft key (*OK*) to perform the appropriate action (*View Data*, *Send Data*, *Delete Last*).

### View Data

The *View Data* screen provides a list of all scanned data including the location, item, quantity, date and time. On this screen, press the right soft key to display menu options to edit a selected record, delete a selected record or delete all records.

Loc	Item	
1	70-33345-01	1
1	70-33345-01	1
1	70-33345-01	1
1	70-33345-01	1
1	70-33345-01	1
1	70-33345-01	1

Figure 2-43 *View Data Screen*

### Send Data

Select this option to transmit scanned data to the host PC MCL Link application.

### Delete Last

Select this option to delete the last item scanned.

## Image Viewer (Devices Equipped with Imagers)

The *Image Viewer* screen allows the user to preview, snap and save images.

To access *Imager Sample*, start at the *Home* screen, scroll to *Imager Sample* and press *ENT*



Figure 2-44 *Image Viewer Screen*

### Menu

Press the left soft key to display the *Menu*.



Figure 2-45 *Image Viewer Screen - Menu*

### Preview On

Scroll to *Preview On* and press *ENT* to display a preview of an image. Point the scan window at the image and press the scan trigger to take a picture.

### Open

Scroll to *Open* and press *ENT* to display the *File Explorer*. Press the Up or Down *Scroll* key to find an image and press *ENT* to display it.

## Options

Scroll to *Options* and press *ENT* to display the *Options* screen. Press the up or down *Scroll* key to select an option to edit and press *ENT*.

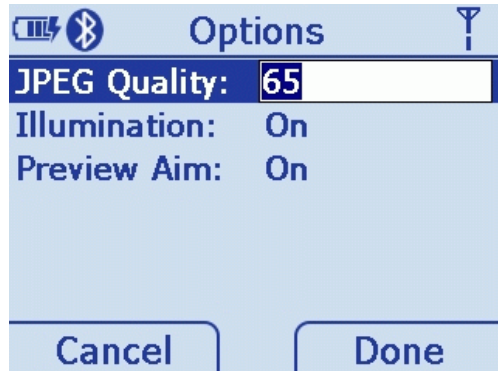

**Figure 2-46** *Options Screen*

- **JPEG Quality:** Picture quality indicator. Higher numbers produce better quality pictures and larger file sizes).
- **Illumination:** Press the right and left scroll keys to turn illumination On or Off. The default is Off. Depending on the room lighting, an image captured by the device may appear too dark. The illumination feature allows you to adjust the lighting on the snapshot target.
- **Preview Aim:** Laser emits when the trigger is pulled.

## About

Displays information about the Imager demo application.

## Close

Press the right soft key to close the screen and return *Home*.

# Config

To access *Config*, start at the *Home* screen, scroll to *Config...* and press *ENT*.

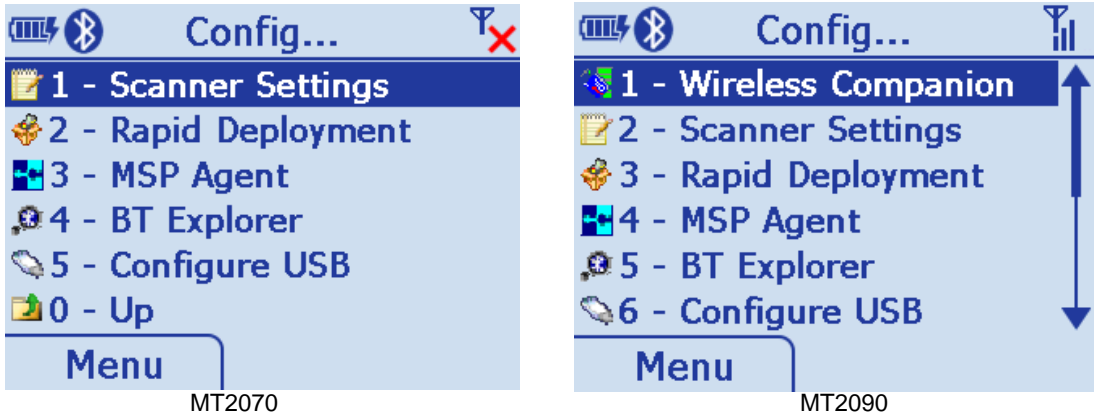

Figure 2-47 Config... Screens

## Wireless Companion (MT2090 Only)

✓ **NOTE** Some screens and windows pictured in this section are samples and can differ from actual screens.

The Wireless Companion is used to configure and manage the device's wireless network settings. On the *Config...* screen press the up or down *Scroll* key to highlight *Wireless Companion* and press *ENT* to display the *Wireless Companion* menu.



Figure 2-48 Config... Wireless Companion Menu

## Find WLANs

On the Wireless Companion menu, press the up or down *Scroll* key to highlight Find WLANs and press *ENT* to display the *Find WLANs* screen.

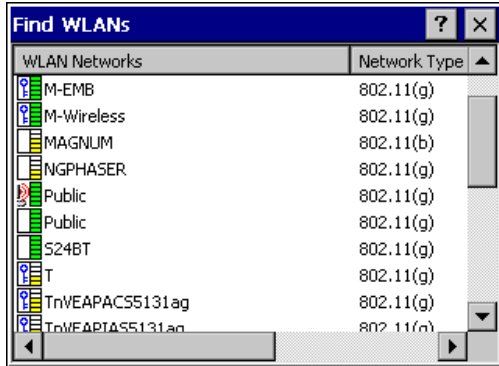

**Figure 2-49** Find WLANs Screen

The Find WLANs list displays:

- WLAN Networks: Available wireless networks.
- Network Type: Type of network. 802.11(a), 802.11(b) or 802.11(g).
- Channel: Channel on which the AP is transmitting.
- Signal Strength: The signal strength of the signal from the AP.

Highlight a network in the list and press *ENT* to open a pop-up menu which provides two options:

Connect and Refresh. Select Refresh to refresh the WLAN list. Select Connect to create a WLAN profile from that network (see [Manage Profiles on page 2-42](#)). This opens the *Profile Entry* screen which allows you to set the values for the selected network. After editing the profile, the device automatically connects to this new profile.

## Manage Profiles

The *Manage Profiles* screen provides a list of user-configured wireless profiles. Define up to 32 profiles at any one time.



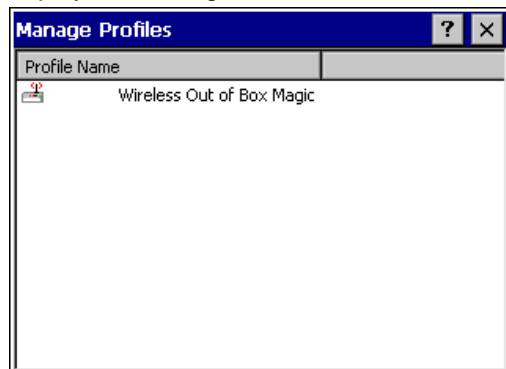



On the *Wireless Companion* menu, press the up or down *Scroll* key to highlight *Manage Profiles* and press *ENT* to display the *Manage Profiles* screen.



**Figure 2-50** Manage Profiles Screen

Icons next to each profile identify the profiles current state.

**Table 2-4** *Profile Icons*

Icon	Description
No Icon	Profile is not selected, but enabled.
	Profile is disabled.
	Profile is Cancelled. A Cancelled profile is disabled until a connect or login function is performed through the configuration editor.
	Profile is currently in use and describes an infrastructure profile not using encryption.
	Profile is currently in use and describes an infrastructure profile using encryption.
	Profile is currently in use and describes an ad-hoc profile not using encryption.
	Profile is currently in use and describes an ad-hoc profile using encryption.
	Profile is not valid in the device current operating regulatory domain.

The profiles are listed in priority order for use by the automatic roaming feature. Change the order by moving profiles up or down. Edit existing profiles by selecting one in the list and then pressing *ENT* to display the menu. The menu allows the selected profile to be connected, edited, disabled (enabled) or deleted. (Note: the **Disable** menu item changes to **Enable** if the profile is already disabled.)

A dialog displays to confirm the users desire to delete a profile, if selected.

### **Changing Profiles**

A completed profile is a set of configuration settings that can be used in different locations to connect to a wireless network. Create different profiles to have pre-defined operating parameters available for use in various network environments. When the *Manage Profiles* screen displays, existing profiles appear in the list.

To change an existing profile, highlight a profile on the *Manage Profiles* screen, press *ENT* to display the menu, scroll to *Edit* and press *ENT*.

### **Creating a New Profile**

Creating a new profile allows the user to configure profile name, ESSID, security, network address information and the power consumption level.

## Profile ID

Press the up or down *Scroll* key on the profile menu and select *Add*. The *Profile Entry* dialog displays.

**Figure 2-51** *Profile Entry Screen*

## Profile Name

The name and (WLAN) identifier of the network connection. Enter a user friendly name for the device profile used to connect to either an AP or another networked device. Example: The Public LAN.

✓ **NOTE** Two profiles with the same user friendly name are acceptable but not recommended.

## ESSID

The ESSID is the 802.11 extended service set identifier. The ESSID is 32-character (maximum) case sensitive string identifying the WLAN and must match the AP ESSID for the device to communicate with the AP.

Tab to *Next >* and press *ENT* to move to the *Operating Mode* dialog.

## Operating Mode

**Figure 2-52** 2-33 *Operating Mode/Country Screen*



**Operating Mode**

Select the operating mode (Infrastructure or Ad-Hoc) from the Operating Mode: drop-down list. The operating mode Infrastructure enables the device to transmit and receive data with an AP. Infrastructure is the default mode.

**Table 2-5** *Operating Mode Fields*

Field	Description
Operating Mode	<p>Infrastructure: Select <b>Infrastructure</b> to enable the device to transmit and receive data with an AP. Infrastructure is the device default mode.</p> <p>Ad Hoc: Select <i>Ad Hoc</i> to enable the device to form its own local network where devices communicate peer-to-peer without APs using a shared ESSID. If <i>Ad-Hoc</i> mode was selected, see <a href="#">Channel on page 2-46</a>. If Infrastructure mode was selected, see <a href="#">Security Mode on page 2-47</a></p>
Country	<p>Country: is used to determine if the profile is valid for the country of operation. The profile country must match the country in the options. page or it must match the acquired country if 802.11d is enabled.</p> <p>Single Country Use: When the device is only to be used in a single country, set every profile country to Allow Any Country. In the <i>Options &gt; Regulatory</i> dialog box (see <a href="#">Figure 2-99 on page 2-77</a>), set the country to the specific country the device is to be used in, and deselect (uncheck) the Enable 802.11d option. This is the most common and the efficient configuration. It eliminates the initialization overhead associated with acquiring a country via 802.11d.</p> <p>Multiple Country Use: When the device may be used in more than one country, select (check) the <i>Enable 802.11d</i> option in the <i>Regulatory Options</i> dialog box (see <a href="#">Figure 2-99 on page 2-77</a>). This eliminates the need for reprogramming the country (in <i>Options &gt; Regulatory</i>) each time a new country is entered. However, this only works if the infrastructure (i.e. APs) support 802.11d (some infrastructures do not support 802.11d, including some Cisco APs). When the Enable 802.11d option is selected, the <i>Options &gt; Regulatory &gt; Country</i> setting is not used. For a single profile that can be used in multiple countries, with infrastructure that supports 802.11d (including Symbol infrastructure), set the Profile Country to Allow Any Country. Under <i>Options &gt; Regulatory</i>, select <i>Enable 802.11d</i>. The <i>Options &gt; Regulatory &gt; Country</i> setting is not used.</p> <p>For a single profile that can be used in multiple countries, but with infrastructure that does not support 802.11d, set the profile country to Allow Any Country, and de-select (uncheck) <i>Enable 802.11d</i>. In this case, the <i>Options &gt; Regulatory &gt; Country</i> setting must always be set to the country the device is currently in. This configuration option is the most efficient and may be chosen for use with any infrastructure. However, the <i>Options &gt; Regulatory &gt; Country</i> setting must be manually changed when a new country is entered.</p> <p>(continued)</p>

Tab to *Next >* and press *ENT* to move to the next dialog.

## Channel

If Ad-Hoc mode was selected the *Ad-Hoc Channel* dialog displays.

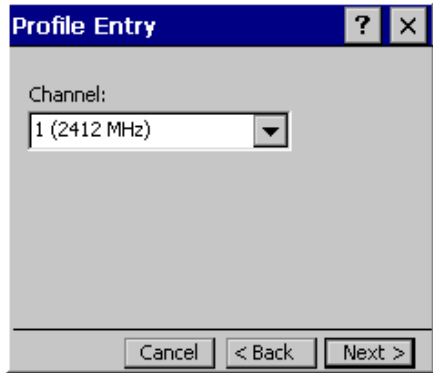

**Figure 2-53** *Ad-Hoc - Channel Screen*

Use the *Ad-Hoc Channel* dialog to configure the required information to create an Ad-Hoc profile. This dialog does not appear if you selected Infrastructure mode. Select a channel number from the Channel drop-down list.

- ✓ **NOTE** In the case of a country where DFS is implemented in band 5150-5250 MHz, Ad-hoc is not allowed and the user needs to move and select a channel in the 2.4 GHz band.
- ✓ **NOTE** Ad-hoc channels are specific to the country selected.

**Table 2-6** *Ad-Hoc Channels*

Band	Channel	Frequency
2.4 GHz	1	2412 MHz
	2	2417 MHz
	3	2422 MHz
	4	2427 MHz
	5	2432 MHz
	6	2437 MHz
	7	2442 MHz
	8	2447 MHz
	9	2452 MHz
	10	2457 MHz
	11	2462 MHz

## Security Mode

If Infrastructure mode was selected the *Security Mode* dialog displays.

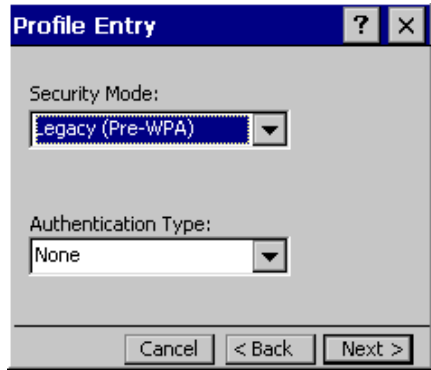

**Figure 2-54** Infrastructure - Security Mode/Authentication Type

## Security Mode

Use the *Security Mode* dialog to configure the *Security and Authentication* methods. If *Ad-Hoc* mode is selected, this dialog is not available and authentication is set to *None* by default.

Select the security mode from the *Security Mode* drop-down list. The selection chosen affects the availability of other choices for *Authentication Type* and *Encryption* methods.

- **LEGACY (Pre-WPA):** This mode allows the user to configure protocols not available in the other Security Mode selections: Open authentication / encryption; Open authentication with WEP 40 or WEP 128; and 802.1X authentications that use WEP128 Encryption.
- **WPA-Personal:** This mode allows the user to configure a WPA-TKIP-PSK protocol.
- **WPA2-Personal** This mode allows the user to configure WPA2-PSK protocols with the Advanced Encryption Standard (AES) encryption method.
- **WPA-Enterprise:** This mode allows the user to configure profiles with 802.1X Authentication that uses WPA and TKIP encryption method.
- **WPA2-Enterprise:** This mode allows the user to configure profiles with 802.1X Authentication that uses WPA2 with AES encryption method.

**Table 2-7** Security Modes

Security Mode	Authentication Types	Encryption Types	Pass-phrase/Hexkey Configuration
Legacy (Pre-WPA)	None, EAP-TLS, EAP-FAST, PEAP, LEAP, TTLS	Open, WEP-40 (40/24), WEP-104 (104/24), TKIP, AES	Enabled. User input required with pass-phrase/hex key configuration.
WPA - Personal	None	TKIP	Enabled. User input required with pass-phrase/hex key configuration.
WPA2 - Personal	None	AES	Enabled. User input required with pass-phrase/hex key configuration.
WPA - Enterprise	EAP-TLS, EAP-FAST, PEAP, LEAP, TTLS	TKIP	Disabled. No user input required for encryption key.
WPA2 - Enterprise	EAP-TLS, EAP-FAST, PEAP, LEAP, TTLS	AES	Disabled. No user input required for encryption key.

## Authentication Type

Select an available authentication type from the drop-down list. The options listed in the drop-down list are based on the selected Security Mode as shown in [Table 2-8](#).

The authentication types, other than None, all use IEEE 802.1x authentication to ensure that only valid users and sometimes servers can connect to the network. Each authentication type uses a different scheme using various combinations of tunnels, username/passwords, user certificates, server certificates and Protected Access Credentials (PACs).

**Table 2-8** Authentication Options

Authentication	Description
None	Use this setting when authentication is not required on the network.
EAP-TLS	Select this option to enable EAP-TLS authentication. A user certificate is required; validating the server certificate is optional.
EAP-FAST	Select this option to enable EAP-FAST authentication. This type uses a PAC (Protected Access Credential) to establish a tunnel and then uses the selected tunnel type to verify credentials. PACs are handled behind the scenes, transparently to the user. Automatic PAC provisioning can, depending on the tunnel type, require a user certificate and the validation of a server certificate. Manual PAC provisioning is currently not supported.
PEAP	Select this option to enable PEAP authentication. This type establishes a tunnel and then based on the tunnel type, uses a user certificate and/or a username/password. Validating the server certificate is optional.
LEAP	Select this option to enable LEAP authentication. This type does not establish a tunnel. It requires a username and password.
TTLS	Select this option to enable TTLS authentication. This type establishes a tunnel and then based on the tunnel type, uses a user certificate and/or a username/password. Validating the server certificate is optional.

Tab to *Next >* and press *ENT*. Selecting PEAP, TTLS or EAP-FAST displays the *Tunneled Authentication Type* dialog. Selecting *None* displays the *Encryption* dialog. Selecting EAP-TLS displays the *Installed User Certs* dialog. Selecting LEAP displays the *User Name* dialog.

## Tunneled Authentication

Use the *Tunneled Authentication Type* dialog to select the tunneled authentication options. The content of the dialog differs depending on the Authentication Type chosen.

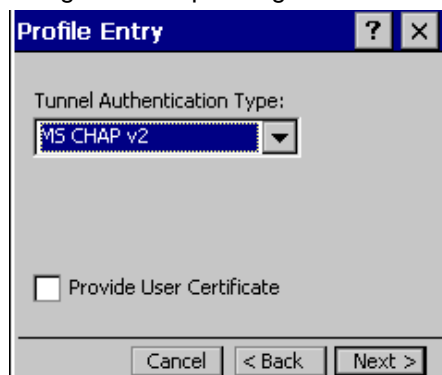

**Figure 2-55** Tunneled Authentication Dialog Box

To select a tunneled authentication type:

1. Select a tunneled authentication type from the drop-down list. See [Table 2-9](#) for the Tunnel Authentication options for each authentication type.
2. Select the *User Certificate* check box if a certificate is required. If the TLS tunnel type that requires a user certificate is selected, the check box is already selected.
3. Tab to *Next >* and press *ENT*. The *Installed User Certificates* dialog displays.

**Table 2-9** Tunneled Authentication Options

Tunneled Authentication	Authentication Type			Description
	PEAP	TTLS	EAP-FAST	
CHAP		X		Challenge Handshake Authentication Protocol (CHAP) is one of the two main authentication protocols used to verify the user name and password for PPP Internet connections. CHAP is more secure than PAP because it performs a three way handshake during the initial link establishment between the home and remote machines. It can also repeat the authentication anytime after the link is established.
EAP-GTC	X		X	EAP-GTC is used during phase 2 of the authentication process. This method uses a time-synchronized hardware or software token generator, often in conjunction with a user PIN, to create a one-time password.
MD5		X		Message Digest-5 (MD5) is an authentication algorithm developed by RSA. MD5 generates a 128-bit message digest using a 128-bit key, IPsec truncates the message digest to 96 bits.
MS CHAP		X		Microsoft Challenge Handshake Authentication Protocol (MS CHAP) is an implementation of the CHAP protocol that Microsoft created to authenticate remote Windows workstations. MS CHAP is identical to CHAP, except that MS CHAP is based on the encryption and hashing algorithms used by Windows networks and the MS CHAP response to a challenge is in a format optimized for compatibility with Windows operating systems.

**Table 2-9** *Tunneled Authentication Options (Continued)*

Tunneled Authentication	Authentication Type			Description
	PEAP	TTLS	EAP-FAST	
MS CHAP v2	X	X	X	Microsoft Challenge Handshake Authentication Protocol version 2 (MS CHAP v2) is a password-based, challenge-response, mutual authentication protocol that uses the industry-standard Message Digest 4 (MD4) and Data Encryption Standard (DES) algorithms to encrypt responses. The authenticating server challenges the access client and the access client challenges the authenticating server. If either challenge is not correctly answered, the connection is rejected. MS CHAP v2 was originally designed by Microsoft as a PPP authentication protocol to provide better protection for dial-up and virtual private network (VPN) connections. With Windows XP SP1, Windows XP SP2, Windows Server 2003 and Windows 2000 SP4, MS CHAP v2 is also an EAP type.
PAP		X		Password Authentication Protocol (PAP) has two variations: PAP and CHAP PAP. It verifies a user name and password for PPP Internet connections, but it is not as secure as CHAP, since it works only to establish the initial link. PAP is also more vulnerable to attack because it sends authentication packets throughout the network. Nevertheless, PAP is more commonly used than CHAP to log in to a remote host like an Internet service provider.
TLS	X		X	EAP TLS is used during phase 2 of the authentication process. This method uses a user certificate to authenticate.

**User Certificate Selection**

If the user checked the *User Certificate* check box on the *Tunneled Authentication* dialog or if TLS is the selected authentication type, the Installed *User Certificates* dialog displays. Select a certificate from the drop-down list of currently installed certificates before proceeding. The selected certificate’s name appears in the drop-down list. If the required certificate is not in the list, install it.

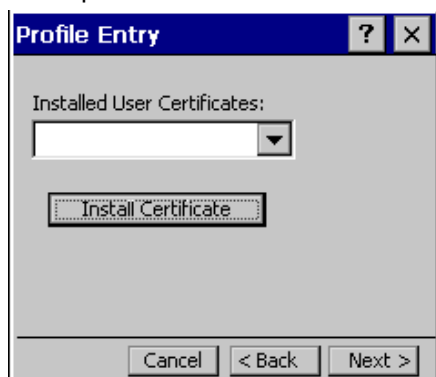

**Figure 2-56** *Installed User Certificates Dialog Box*

### User Certificate Installation

There are two methods available to install a user certificate for authentication. The first is to obtain the user certificate from the Certificate Authority (CA). This requires connectivity with that CA. The second method is to install the user certificate from a file that was placed on the device.

To install a user certificate from the CA:

1. Tab to *Install Certificate* and press *ENT*. The *Import Certificate* dialog displays.

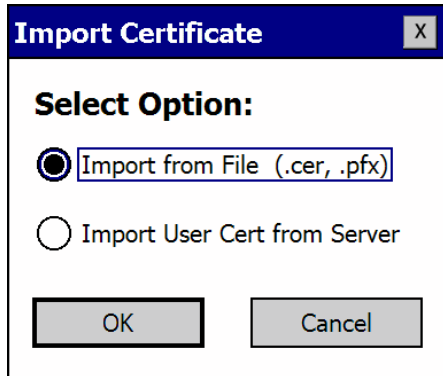

Figure 2-57 *Import Certificate Dialog Box*

2. Select *Import User Cert from Server* and select *OK*. The *Install from Server* dialog displays.

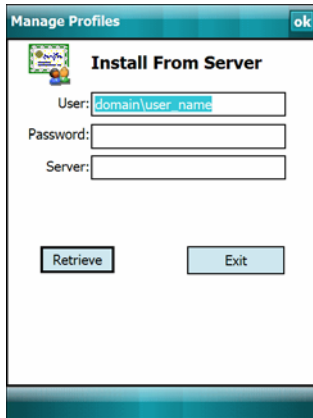

Figure 2-58 *Install from Server Dialog Box*

3. Enter the *User:*, *Password:* and *Server:* information in their respective text boxes.
4. Tab to *Retrieve*. A Progress dialog indicates the status of the certificate retrieval, or tab to *Exit* and press *ENT*. After the installation completes, the *Installed User Certs* dialog displays and the certificate is available in the drop-down for selection.

✓ **NOTE** To successfully install a user certificate, the device must already be connected to a network from which the server is accessible.



To install a user certificate from a file:

- 1. Tab to *Install Certificate* and press *ENT*. The *Import Certificate* dialog displays.

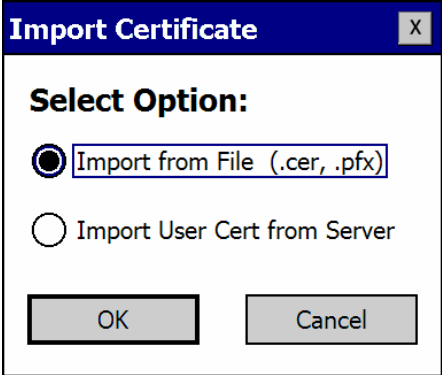

Figure 2-59 *Import Certificate Dialog Box*

- 2. Choose *Import from File* and select *OK*. The *Open* dialog displays.

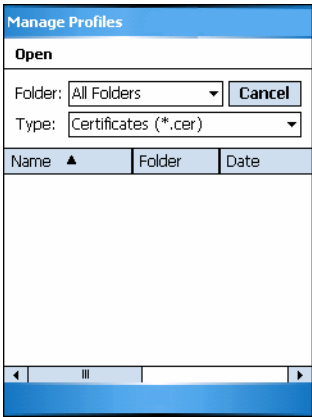

Figure 2-60 *Open Dialog Box*

- 3. In the *Type* drop-down list, select *Personal Certs (\*.pfx)*.
- 4. Browse to the file and select *OK*. The *Personal Certificate* dialog displays.



Figure 2-61 *Personal Certificate Screen*

5. Enter the password and select *OK*. The certificate(s) are imported.

- ✓ **NOTE** Installing a user certificate from a file requires that the file be of type “\*.pfx”. Also this file type requires the user to supply a password in order to be read by Fusion.

### **Server Certificate Selection**

If the user selects the *Validate Server Certificate* check box, a server certificate is required.

Select a certificate from the drop-down list of currently installed certificates in the *Installed Server Certificates* dialog. An hour glass may appear as the wizard populates the existing certificate list. If the required certificate is not listed, install it.

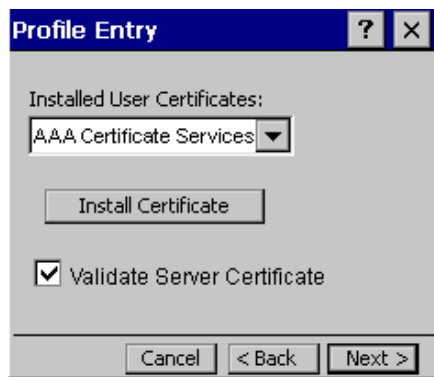
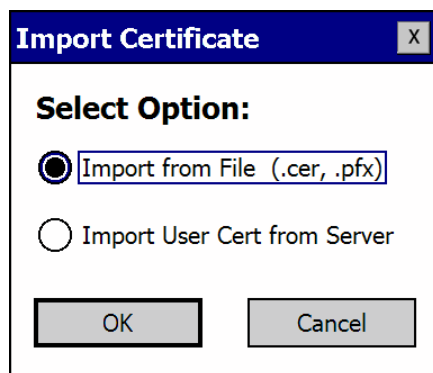

**Figure 2-62** *Installed Server Certificates Dialog Box*

### **Server Certificate Installation**

To install a server certificate for authentication:

1. Tab to *Install Certificate* and press *ENT*. The *Import Certificate* dialog displays. Choose *Import from File* (.cer, .pfx) and select *OK*.



**Figure 2-63** *Import Certificates Dialog Box*

2. A dialog displays that lists the certificate files found with the default extension.

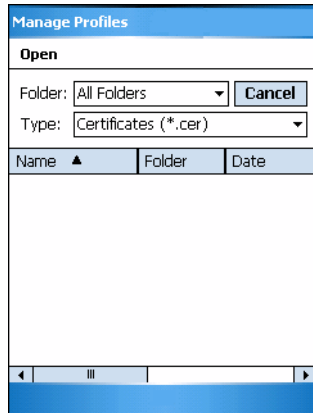

Figure 2-64 Open Screen

3. Browse to the file and select OK.
4. A confirmation dialog verifies the installation. If the information in this dialog is correct, select Yes. If the information in this dialog is not correct select No. The wizard returns to the Installed *Server Certs* dialog. Select the newly-installed certificate from the drop-down list.

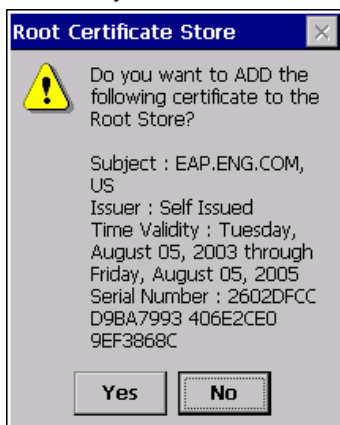

Figure 2-65 Confirmation Dialog Box

### User Name

The user name and password can be entered (but is not required) when the profile is created. If the username and password are not entered in the profile, then when attempting to connect, the user is prompted to supply them. The entered information (credentials) is saved (cached) for future reconnections.

Whether or not the username and password are entered into the profile affects how the profile is treated during a Profile Roaming operation. Profiles are excluded from consideration if they require user entry of credential information.

If the profile uses an authentication tunnel type of EAP-GTC and Token is selected (see [Password on page 2-56](#)), then you can control certain behavior by whether you choose to enter a value in the *Enter User Name* field. If you enter a value in the *Enter User Name* field, then whenever the Fusion software prompts you to enter credentials, the *username* field in the interactive credential dialog is initialized with the value that you entered when you created the profile. If you enter a different value in the *username* field of the interactive credential dialog, it is cached and used to initialize the *username* field the next time the interactive credential dialog is shown for that profile. If you do not enter a value in the *Enter User Name* field when you create an EAP-GTC token profile, then the *username* field in the interactive credential dialog is initialized to blank. After you enter a username in the interactive credential

dialog, it is cached as usual, but it is not be used to initialize the *username* field the next time the interactive credential dialog is shown for that profile; the *username* field is initialized to blank. In summary, the user can control whether the *username* field in the interactive credential dialog is initialized, either with the last-interactively-entered username for that profile or with the username entered into the profile, by whether any value is entered in the *Enter User Name* field during profile entry.

**Figure 2-66** Username Dialog Box

### Password

Use the *Password* dialog to enter a password. If EAP/TLS is the selected authentication type, the password dialog does not display. Note that if a username was entered and no password is entered, Fusion assumes that no password is a valid password.

**Figure 2-67** Password Dialog Box

1. Enter a password in the *Enter Password* field. If an authentication tunnel type of EAP-GTC is used, a *Password* dialog with additional radio buttons displays.

**Figure 2-68** EAP-GTC Password Dialog Box

Two radio buttons are added to allow the user to choose a token or static password.

Choose the *Token* radio button when using the profile in conjunction with a token generator (hardware or software). The system administrator should supply the user with a token generator for use with EAP-GTC token profiles. A token generator generates a numeric value that is entered into the *password* field at connect time, usually along with a PIN. Tokens have a very limited lifetime and usually expire within 60 seconds. The token generator is time-synchronized with a token server. When authenticating, the RADIUS server asks the token server to verify the token entered. The token server knows what value the token generator generates given the time of day and the username. Since tokens expire, EAP-GTC token profiles are treated differently. A prompt appears at the appropriate time to enter a token, even if a token has previously been entered. Tokens are never cached in the credential cache (though the username that is entered when the token is entered is cached).

Choose the *Static* radio button, the *Enter Password* field is enabled and a password can be entered if desired. A profile that uses an EAP-GTC tunnel type with a static password is handled in the same manner as other profiles that have credentials that don't expire.

1. Select the *Advanced ID* check box, if advanced identification is desired.
2. Tab to *Next >* and press *ENT*. The prompt for *Login* at dialog displays. See [Credential Cache Options on page 2-58](#).

### Advanced Identity

Use the *Advanced ID* dialog to enter the 802.1X identity to supply to the authenticator. This value can be 63 characters long and is case sensitive. In TTLS and PEAP, it is recommended entering the identity anonymous (rather than a true identity) plus any desired realm (e.g., anonymous@myrealm). A user ID is required before proceeding.

✓ **NOTE** When authenticating with a Microsoft IAS server, do not use advanced identity.

The image shows a dialog box titled "Profile Entry" with a close button (X) in the top right corner. Inside the dialog, there are two text input fields. The first is labeled "Enter 802.1x Identity" and the second is labeled "Enter Domain:". Below these fields, there are three buttons: "Cancel", "< Back", and "Next >".

**Figure 2-69** *Advanced Identity Dialog Box*

Tab to *Next >* and press *ENT*. The *Encryption* dialog displays.

## Credential Cache Options

If the user selected any of the password-based authentication types then different credential caching options are available. These options specify when the network credential prompts appear: at connection, on each resume or at a specified time.

Entering the credentials directly into the profile permanently caches the credentials. In this case, the device does not require user login. If a profile does not contain credentials entered through the Profile Editor Wizard, credentials must be entered when prompted, either when connecting to the profile in the *Manage Profiles* screen or when logging onto the profile using the Log On/Off command.

Credential caching options only apply to a profile when credentials are entered through the login dialog. This includes using the Log On/Off command to log on to a profile for which the credentials were directly entered into the profile (the *username / password* fields left blank).

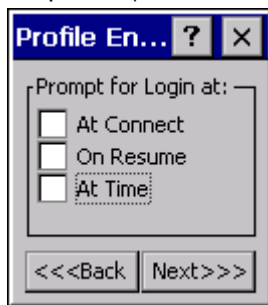

**Figure 2-70** Prompt for Login at Dialog Box

If the device does not have the credentials, a username and password must be entered. If the device has the credentials (previous entered via a login dialog), it uses these credentials unless the caching options require the device to prompt for new credentials. If credentials were entered via the profile, the device does not prompt for new credentials (except for profiles where the credentials expire, such as EAP-GTC token profiles). [Table 2-10](#) lists the caching options.

**Table 2-10** Cache Options

Option	Description
At Connect	Select this option to have device prompt for credentials whenever it tries to connect to the profile. Deselect this to use the cached credentials to authenticate. If the credentials are not cached, the user is prompted to enter credentials. This option only applies when the user has previously logged in to the profile.
On Resume	Selecting this re-authenticates an authenticated user when a suspend/resume occurs. Once re-authenticated, the user is prompted for credentials. If the user does not enter the same credentials that were entered prior to the suspend/resume within three attempts, the user is disconnected from the network. This option only applies when the user has previously logged in to the profile.
At Time	Select this option to perform a local verification on an authenticated user at a specified time. The time can be an absolute time or a relative time from the authentication and should be in at least five minute intervals. Once the time has passed, the user is prompted for credentials. If the user does not enter the same credentials that were entered prior to the At-Time event within three attempts, the user is disconnected from the network. This option only applies when the user has previously logged in to the profile.

- ✓ **NOTE** Entering credentials applies the credentials to a particular profile. Logging out clears all cached credentials. Editing a profile clears any cached credentials for that profile.

Users who configure their APs to use the Fast Session Resume capability available with some Authentication Types (e.g., PEAP) should not check *At Connect* or *On Resume* if they wish to avoid being prompted to re-enter credentials in circumstances in which Fast Session Resume would allow them not to be.

The following authentication types have credential caching:

- EAP-TLS
- PEAP
- LEAP
- TTLS
- EAP-FAST.

Some exceptions to the credential caching rules apply for profiles where the credentials expire, such as EAP-GTC token profiles. Since the token expires after a short period, the user is prompted for credentials even when credentials have already been entered and cached for that profile. The *At Connect* caching option has a slightly different function. If the user leaves the *At Connect* box unchecked, then the Fusion software tries to authenticate without prompting the user for a new token. If *Fast Session Reconnect* is enabled on the RADIUS server and the device was previously connected and authenticated using the same profile, then the device may be able to reconnect without going through the entire authentication process. In this case, new credentials are not required (even though the old ones have expired) and the Fusion software does not prompt the user for new credentials. If *Fast Session Reconnect* is not enabled on the RADIUS server or if the user selected the *At Connect* check box, then the user is prompted to enter new credentials. Note also that the *On Resume* caching option is always forced to “checked” for profiles where the credentials expire. This is necessary because the Fusion software does not support the use of *Fast Session Reconnect* across a suspend / resume cycle; therefore, new credentials are always needed.

Selecting the *At Time* check box displays the *Time Cache Options* dialog.

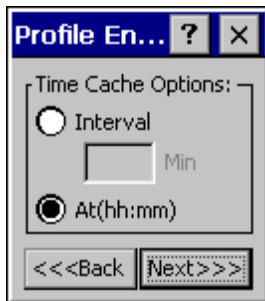

**Figure 2-71** *Time Cache Options Dialog Box*

1. Tab to the *Interval* radio button and press *ENT* to check credentials at a set time interval.
2. Enter the value in minutes in the text box.
3. Select the *At(hh:mm)* radio button to check credentials at a set time.

4. Tab to *Next >* and press *ENT*. The *At Time* dialog displays.

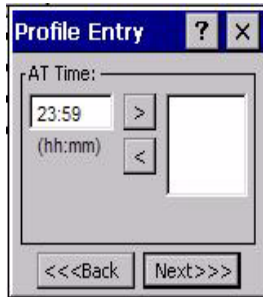
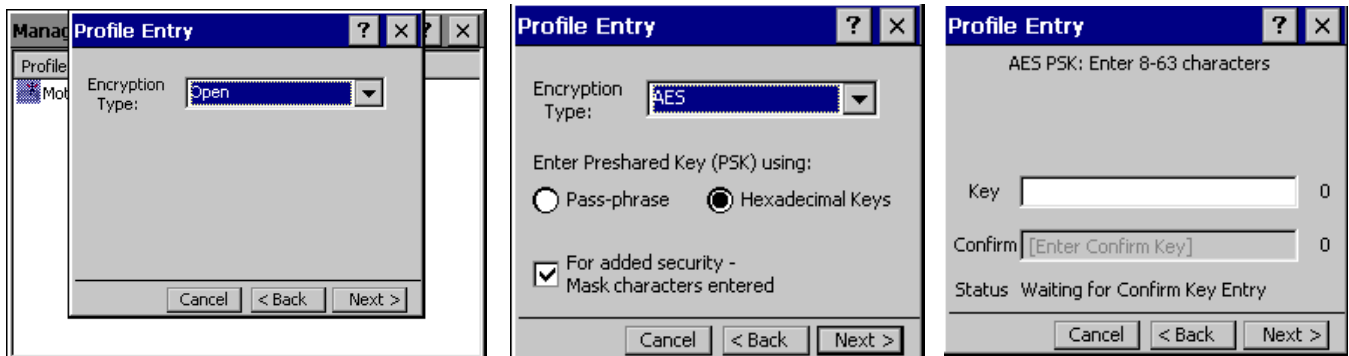

**Figure 2-72** *At Time Dialog Box*

5. Enter the time using the 24 hour clock format in the (hh:mm) text box.
6. Select > to move the time to the right. Repeat for additional time periods.
7. Tab to *Next >* and press *ENT*. The *Encryption* dialog displays.

## Encryption

- ✓ **NOTE** The only available encryption methods in Ad-hoc are Open, WEP40 and WEP104. Use the *Encryption* dialog to select an encryption method. This page contains the fields to configure the encryption method and corresponding keys, if any. The drop-down list includes encryption methods available for the selected security mode and authentication type.



**Figure 2-73** *Encryption Dialog Boxes*

Based on the encryption method and the authentication type, the user may have to manually enter pre-shared encryption keys (or a passkey phrase). When the user selects any authentication type other than None, 802.1x authentication is used and the keys are automatically generated.



**Table 2-11** Encryption Options

Encryption	Description
Open	Select Open (the default) when no data packet encryption is needed over the network. Selecting this option provides no security for data transmitted over the network.
WEP-40 (40/24)	<p>Select WEP-40 (40/24) to use 64-bit key length WEP encryption (the other 24 bits are generated automatically). If WEP-40 (40/24) is selected, other controls appear that allow you to enter keys. If the <i>Use Passkey</i> check box is selected, the user is asked to enter a pass phrase between 4 and 32 characters long on the next page. Once the profile is saved, the pass phrase is converted into a key and the pass phrase is lost. Also, if a passkey is used only one key can be set.</p> <p>If the <i>Use Passkey</i> check box is not selected, then the user can enter up to four hexadecimal keys on the next page. Which key is to be entered is determined by selecting a key in the Key Index drop-down menu. The key index chosen also selects the key used for encryption. Note that Fusion sets default values for these keys, so that entry is not absolutely required, but remember that the keys must match the AP.</p>
WEP-104 (104/24)	<p>Select WEP-104 (104/24) to use a 128-bit key length WEP encryption. If WEP-104 (104/24) is selected, other controls appear that allow you to enter keys. If the <i>Use Passkey</i> check box is selected, the user is asked to enter a pass phrase between 4 and 32 characters long on the next page. Once the profile is saved, the pass phrase is converted into a key and the pass phrase is lost. Also, if a passkey is used only one key can be set.</p> <p>If the <i>Use Passkey</i> check box is not selected, then the user can enter up to four hexadecimal keys on the next page. Which key is to be entered is determined by selecting a key in the <i>Key Index</i> drop-down menu. The key index chosen also selects the key used for encryption. Note that Fusion sets default values for these keys, so that entry is not absolutely required, but remember that the keys must match the AP.</p>
TKIP	Select TKIP for the adapter to use the Temporal Key Integrity Protocol (TKIP) encryption method. This encryption method is available whenever the Security Mode is not set to Legacy. If the Security Mode is set to WPA personal, then the user is asked to enter a pass phrase between 8 and 63 characters long on the next page.
AES	Select AES for the adapter to use the Advanced Encryption Standard (AES) encryption method. This encryption method is available for many of the Security Modes. If the Security Mode selected is "personal," the user is asked to enter a pass phrase between 8 and 63 characters long on the next page.

**Table 2-12** Encryption / Authentication Matrix

Authentication	Encryption					
	Legacy (Pre-WPA)		WPA Personal	WPA2 Personal	WPA Enterprise	WPA2 Enterprise
	Open	WEP	TKIP	AES	TKIP	AES
None	Yes	WEP-40 or WEP-104	Yes	Yes		
EAP-TLS		WEP-104			Yes	Yes
EAP-FAST		WEP-104			Yes	Yes

**Table 2-12** Encryption / Authentication Matrix (Continued)

Authentication	Encryption					
	Legacy (Pre-WPA)		WPA Personal	WPA2 Personal	WPA Enterprise	WPA2 Enterprise
	Open	WEP	TKIP	AES	TKIP	AES
PEAP		WEP-104			Yes	Yes
LEAP		WEP-104			Yes	Yes
TTLS		WEP-104			Yes	Yes

If either WEP-40 (40/24) or WEP-104 (104/24) is selected, the wizard displays the key entry dialog unless the *Use Passkey* check box was selected in the *Encryption* dialog (see [Figure 2-67 on page 2-56](#)). The *Key Entry* dialog shows only if the authentication is set to *None*.

### Hexadecimal Keys

To enter the hexadecimal key information select the Hexadecimal Keys radio button. An option is provided to hide the characters that are entered for added security. To hide the characters select the *For added security - Mask characters entered* check box.

To enter a hexadecimal key with characters hidden:

1. Select the *For added security - Mask characters entered* check box.
2. Tab to *Next >* and press *ENT*.

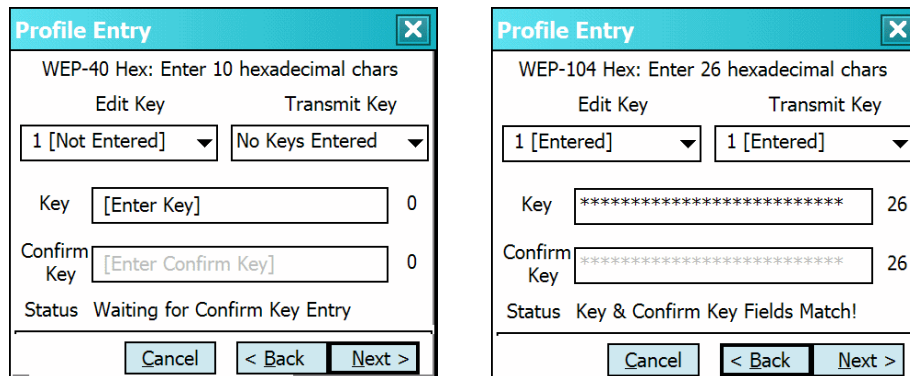

**Figure 2-74** WEP-40 and WEP-104 WEP Keys Dialog Boxes

3. For WEP only, in the *Edit Key* drop-down list, select the key to enter.
4. In the *Key* field, enter the key.
  - a. For WEP-40 enter 10 hexadecimal characters.
  - b. For WEP-104 enter 26 hexadecimal characters.
  - c. For TKIP enter 64 hexadecimal characters.
  - d. For AES enter 64 hexadecimal characters.
5. In the *Confirm Key* field, re-enter the key. When the keys match a message appears indicating that the keys match.
6. Repeat for each WEP key.

7. For WEP only, in the *Transmit Key* drop-down list, select the key to transmit.
8. Tab to *Next >* and press *ENT*. The *IP Address Entry* dialog displays.

To enter a hexadecimal key without characters hidden:

1. Tab to *Next >* and press *ENT*.

**Figure 2-75** *Keys Dialog Box*

2. For WEP only, in each *Key* field, enter the key.
  - a. For WEP-40 enter 10 hexadecimal characters.
  - b. For WEP-104 enter 26 hexadecimal characters.
  - c. For TKIP enter 64 hexadecimal characters.
  - d. For AES enter 64 hexadecimal characters.
3. For WEP only, in the *Transmit Key* drop-down list, select the key to transmit.
4. Tab to *Next >* and press *ENT*. The *IP Address Entry* dialog displays.

### ***Pass-phrase Dialog***

When selecting *None* as an authentication and WEP as an encryption, choose to enter a pass-phrase by checking the *Pass-phrase* radio button. The user is prompted to enter the pass-phrase. For WEP, the *Pass-phrase* radio button is only available if the authentication is *None*.

When selecting *None* as an authentication and TKIP as an encryption, the user must enter a pass-phrase. The user cannot enter a pass-phrase if the encryption is TKIP and the authentication is anything other than *None*.

When selecting *None* as an authentication and AES as an encryption, the user must enter a pass-phrase. The user cannot enter a pass-phrase if the encryption is AES and the authentication is anything other than *None*.

To enter a pass-phrase with characters hidden:

1. Select the *For added security - Mask characters entered* check box.
2. Tab to *Next >* and press *ENT*.

**Figure 2-76** WEP-40 and WEP-104 WEP Keys Dialog Boxes

3. In the *Key* field, enter the key.
  - a. For WEP-40 enter between 4 and 32 characters.
  - b. For WEP-104 enter between 4 and 32 characters.
  - c. For TKIP enter between 8 and 63 characters.
  - d. For AES enter between 8 and 63 characters.
4. In the *Confirm Key* field, re-enter the key. When the keys match a message appears indicating that the keys match.
5. Tab to *Next >* and press *ENT*. The *IP Address Entry* dialog displays.

To enter a pass-phrase key without characters hidden:

1. Tab to *Next >* and press *ENT*.

**Figure 2-77** Keys Dialog Box

2. In the *Key* field, enter the key.
  - a. For WEP-40 enter between 4 and 32 characters.
  - b. For WEP-104 enter between 4 and 32 characters.
  - c. For TKIP enter between 8 and 63 characters.
  - d. For AES enter between 8 and 63 characters. Tab to *Next >* and press *ENT*. The *IP Address Entry* dialog displays.

## IP Address Entry

Use the *IPv4 Address Type* dialog to configure network address parameters: IP address, subnet mask, gateway, DNS and WINS.

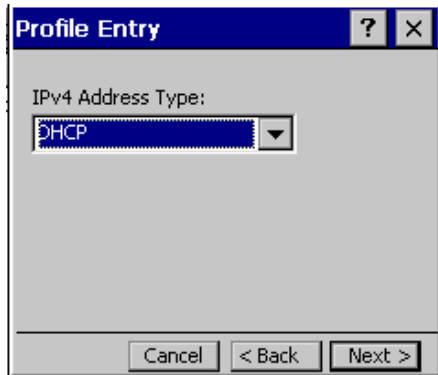

Figure 2-78 IPv4 Address Type Dialog Box

Table 2-13 IP Address Entry

Encryption	Description
DHCP	Select Dynamic Host Configuration Protocol (DHCP) from the IP Address Entry drop-down list to obtain a leased IP address and network configuration information from a remote server. DHCP is the default setting for the device profile. Ad-hoc mode does not support DHCP. Use only Static IP address assignment.
Static	Select Static to manually assign the IP, subnet mask, default gateway, DNS and WINS addresses the device profile uses.

Select either DHCP or Static from the drop-down list and tab to *Next >* and press *ENT*. Selecting *Static IP* displays the *IP Address Entry* dialog. Selecting DHCP displays the *Transmit Power* dialog.

Use the *IP Address Entry* dialog to enter the IP address and subnet information.

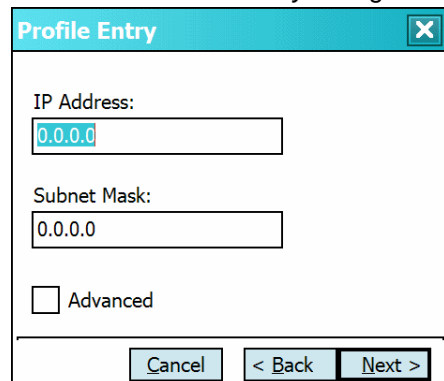

Figure 2-79 Static IP Address Entry Dialog Box

**Table 2-14** Static IP Address Entry Fields

Field	Description
IP Address	The Internet is a collection of networks with users that communicate with each other. Each communication carries the address of the source and destination networks and the particular machine within the network associated with the user or host computer at each end. This address is called the IP address (Internet Protocol address). Each node on the IP network must be assigned a unique IP address that is made up of a network identifier and a host identifier. Enter the IP address as a dotted-decimal notation with the decimal value of each octet separated by a period, for example, 192.168.7.27.
Subnet Mask	Most TCP/IP networks use subnets to manage routed IP addresses. All IP addresses have a network part and a host part. The network part specifies a physical network. The host part specifies a host on that physical network. The subnet mask allows a network administrator to use some of the bits that are normally used to specify the host to instead specify physical sub-networks within an organization. This helps organize and simplify routing between physical networks.

Select the *Advanced* check box, then tab to *Next >* and press *ENT* to display the *Advanced Address Entry* dialog. Enter the Gateway, DNS and WINS addresses. Tab to *Next >* and press *ENT* without selecting the *Advanced* check box to display the *Transmit Power* dialog.

**Figure 2-80** Advanced Address Entry Dialog Box

The IP information entered in the profile is only used if the *Enable IP Mgmt* check box in the *Options > System Options* dialog was selected ([System Options on page 2-78](#)). If not selected, the IP information in the profile is ignored and the IP information entered in the Microsoft interface applies.

**Table 2-15** IP Config Advanced Address Entry Fields

Field	Description
G/W	The default gateway forwards IP packets to and from a remote destination.
DNS	The Domain Name System (DNS) is a distributed Internet directory service. DNS translates domain names and IP addresses and controls Internet email delivery. Most Internet services require DNS to operate properly. If DNS is not configured, Web sites cannot be located and/or email delivery fails.
WINS	WINS is a Microsoft® Net BIOS name server. WINS eliminates the broadcasts needed to resolve computer names to IP addresses by providing a cache or database of translations.

Tab to *Next >* and press *ENT*. The *Transmit Power* dialog displays.

### Transmit Power

The *Transmit Power* drop-down list contains different options for Ad-Hoc and Infrastructure mode. Automatic (i.e., use the current AP settings) and Power Plus (use higher than the current AP settings) are available for Infrastructure mode.

Adjusting the radio transmission power level enables the user to expand or confine the transmission coverage area. Reducing the radio transmission power level reduces potential interference to other wireless devices that might be operating nearby. Increasing the radio transmission power level increases the range at which other wireless devices can “hear” the radio’s signal.

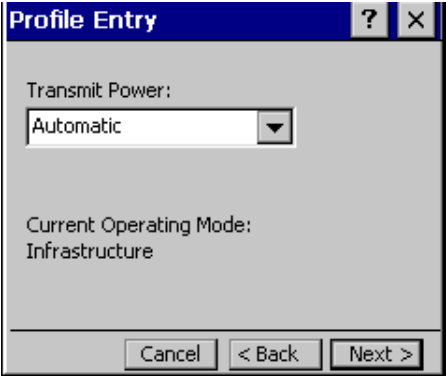

Figure 2-81 *Transmit Power Dialog Box (Infrastructure Mode)*

Table 2-16 *Transmit Power Dialog Box (Infrastructure Mode)*

Field	Description
Automatic	Select Automatic (the default) to use the AP power level.
Power Plus	Select Power Plus to set the device transmission power one level higher than the level set for the AP. The power level is set to conform to regulatory requirements.

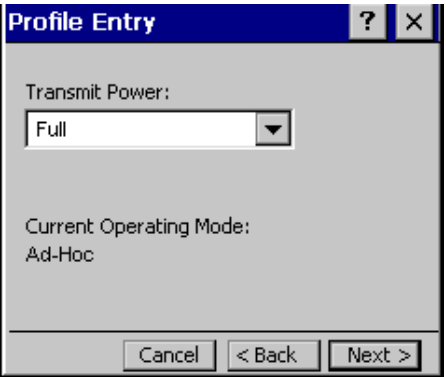

Figure 2-82 *Transmit Power Dialog Box (Ad-Hoc Mode)*

**Table 2-17** Power Transmit Options (Ad-Hoc Mode)

Field	Description
Full	Select Full power for the highest transmission power level. Select Full power when operating in highly reflective environments and areas where other devices could be operating nearby or when attempting to communicate with devices at the outer edge of a coverage area.
30 mW	Select 30 mW to set the maximum transmit power level to 30 mW. The radio transmits at the minimum power required.
15 mW	Select 15 mW to set the maximum transmit power level to 15 mW. The radio transmits at the minimum power required.
5 mW	Select 5 mW to set the maximum transmit power level to 5 mW. The radio transmits at the minimum power required.
1 mW	Select 1 mW for the lowest transmission power level. Use this level when communicating with other devices in very close proximity or in instances where little or no radio interference from other devices is expected.

Tab to *Next* > and press *ENT* to display the *Battery Usage* dialog.

### Battery Usage

Use the *Battery Usage* dialog to select power consumption of the wireless LAN. There are three settings available: CAM, Fast Power Save and MAX Power Save. Battery usage cannot be configured in Ad-Hoc profiles.

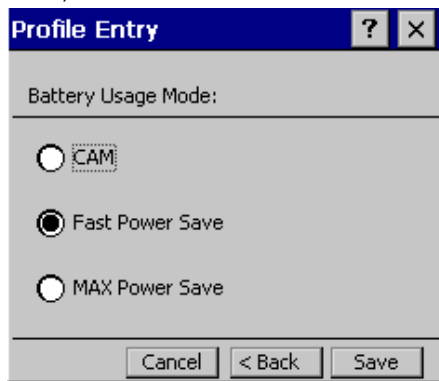

**Figure 2-83** Battery Usage Dialog Box



**NOTE** Power consumption is also related to the transmit power settings.



**Table 2-18** *Battery Usage Options*

Field	Description
CAM	Continuous Aware Mode (CAM) provides the best network performance, but yields the shortest battery life.
Fast Power Save	Fast Power Save (the default) performs in the middle of CAM and MAX Power Save with respect to network performance and battery life.
MAX Power Save	Max Power Save yields the longest battery life while potentially reducing network performance. In networks with minimal latency, Max Power Save performs as well as Fast Power Save, but with increased battery conservation.

**Deleting a Profile**

To delete an existing profile, highlight a profile on the *Manage Profiles* screen, press *ENT* to display the menu, scroll to *Delete* and press *ENT*.

**Ordering Profiles**

To change the order of existing profiles, highlight a profile on the *Manage Profiles* screen, press *ENT* to display the menu, scroll to *Move Up* or *Move Down* and press *ENT*.

If the current profile association is lost, the device attempts to associate with the first profile in the list, then the next, until it achieves a new association.

**Exporting a Profile**

To export a profile to a registry file, highlight a profile on the *Manage Profiles* screen, press *ENT* to display the menu, scroll to *Export* and press *ENT*. The *Save As* dialog displays with the *Application* folder.

**Manage Certificates**

Users can view and manage security certificates in the various certificate stores. Tab to *Manage Certs* and press *ENT*. The *Certificate Manager* screen displays.

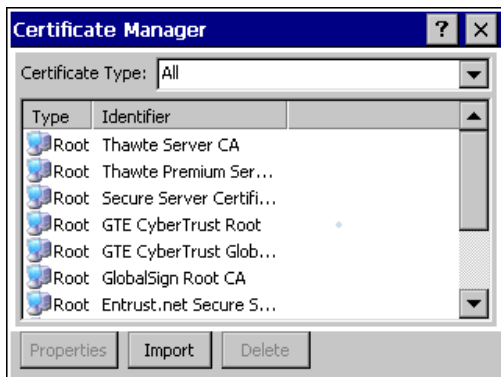

**Figure 2-84** *Manage Certificates Screen*

Various certificate types display at one time. Select the *Certificate Type* drop-down box to filter the certificate list to display All, only *Root/Server* or only *User/Client* certificates.

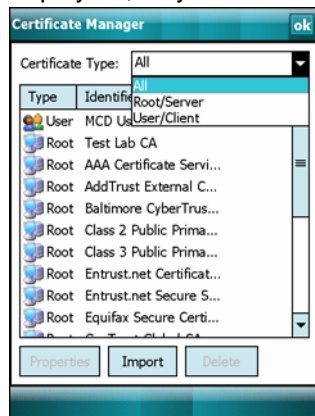

**Figure 2-85** *Certificate Type Options Screen*

The *Certificate Manager* screen contains command buttons at the bottom of the screen. A button might be disabled (gray) if the operation cannot be performed based on any selected object.

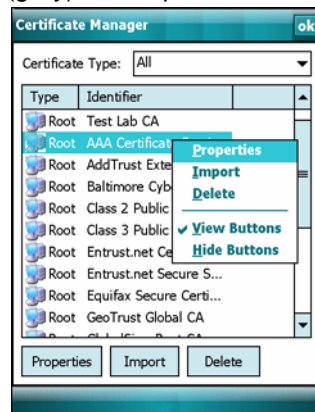

**Figure 2-86** *Command Buttons and Context Menu*

These buttons can be hidden to allow more space for displaying the list of certificates. To hide the buttons press *ENT*. The menu displays.

Select *Hide Buttons* to hide the command buttons.

To display the buttons select *View Buttons* from the menu.

The menu also allows the user to select the *Properties*, *Import* and *Delete* commands.

### ***Certificate Properties***

To display the detailed properties of a certificate, select a certificate in the list, press *ENT* to display the menu and select Properties. The screen displays the properties of the certificate. Select a property in the upper list and the detailed information displays in the Expanded Value section.

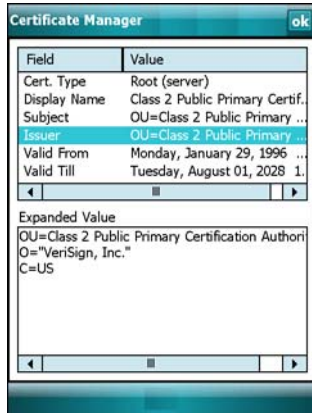

**Figure 2-87** *Certificate Properties Screen*

Select *ok*, *Escape* or *X* to exit (depending on the device).

### ***Import a Certificate***

Import certificates from either files or from a server machine:

- **.CER file:** DER encrypted Root/Server certificates.
- **.PFX file:** Personal inFormation eXchange formatted file containing one or more Root/Server and/or User/Client Certificates. These files are usually protected by a password and a password prompt appears. If there is no password, enter nothing and select OK.
- **Server:** User/Client certificates can be requested directly from a Certificate Authority (CA) on the network. A User name, Password (optional) and the Server (an IP address) must be provided to obtain a certificate for the User from the CA.

Select Import or select from the context menu. The *Import Certificate* dialog displays.

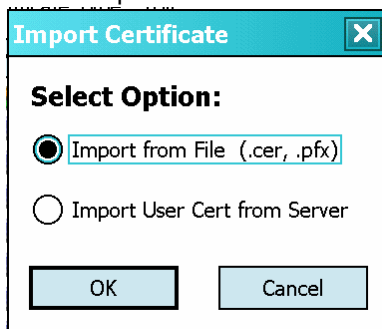

**Figure 2-88** *Import Certificate Dialog Box*

Select the *Import from File* (.cer, .pfx) radio button to import a certificate file. The *Open* screen displays. Select the file to import.

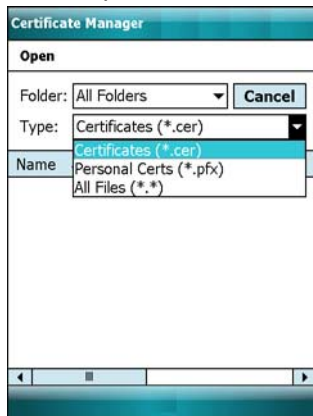

**Figure 2-89** Certificate Manager Screen

Select the *Import User Cert from Server* radio button to import a certificate from a server. The *Install From Server* screen displays.

Enter the user, password and server information in the respective text boxes.

Select *Retrieve* to import the certificate.

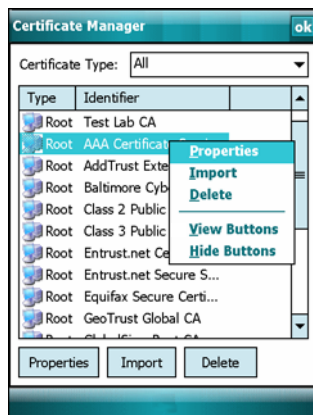

**Figure 2-90** Install From Server Screen

### Delete a Certificate

To delete a certificates:

Select the certificate to delete.

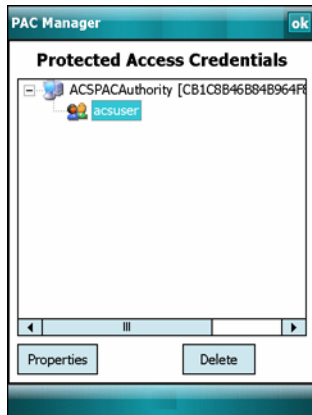

**Figure 2-91** Import Certificate Dialog Box

Select *Delete* from the menu.

## Manage PACs

Users can view and manage Protected Access Credentials (PACs) used by Cisco's EAP-FAST authentication protocol. On the *Wireless Companion* menu scroll to Manage PACs and press *ENT*. The *PAC Manager* screen displays.



**Figure 2-92** *PAC Manager Screen*

PACs are uniquely identified by referencing a PAC Authority Identifier (A-ID) (the server that issued the PAC) and by the individual user identifier (I-ID). The PACs display sorted by A-ID (default) or by I-ID in a tree display.

The *PAC Manager* screen contains buttons at the bottom of the screen. A button might be disabled (gray) if the operation cannot be performed based on any selected object.

These buttons can be hidden to allow more space for displaying the list of certificates. To hide the buttons press *ENT* to display the menu.

Select *Hide Buttons* to hide the buttons.

To display the buttons select *View Buttons* from the menu.

The menu also allows the user to select the *Properties* and *Delete* commands.

You can always sort by A-ID, sort by I-ID, view buttons and hide buttons in the menu.

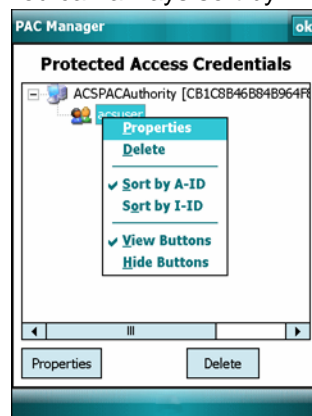

**Figure 2-93** *Command Buttons and Context Menu*

### **PAC Properties**

Display the detailed properties of a PAC by selecting an item in a sub-tree and selecting Properties or pop-up menu. The following screen displays with the list of properties in the upper portion of the screen. By selecting an entry in the upper list, the expanded details of the entry property displays in the lower list of the screen.

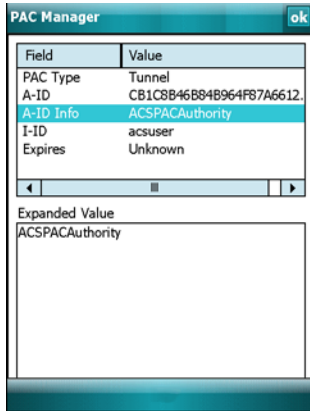

**Figure 2-94** PAC Properties Popup

To return to the main page, select **Ok**, *Escape* or *X* depending on the device.

### **Delete PAC**

To delete a single PAC, select a leaf item (right most tree item) to select the PAC, then select **Delete** or pop-up menu. A confirmation dialog displays.

To delete a group of PACs having the same A-ID or same I-ID, sort the PACs by desired ID type, then select the parent item (left most tree item) to select the group. Select **Delete** or pop-up menu and a confirmation dialog displays.

### **Import PAC**

Usually PACs are automatically provisioned to the device over the air the first time EAP-FAST authentication occurs. For increased security, an administrator may choose to manually provision the device with a PAC instead. In this case, the administrator must generate an appropriate PAC file manually using commands on the PAC Authority. Once the PAC file is generated, it must be manually transferred to the device's file system before it can be imported by the Manage PACs application.

To import a PAC, select the **Import** button. A dialog displays asking you to select the PAC file to be imported.

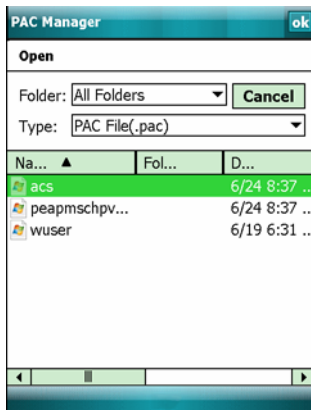

**Figure 2-95** Open Screen

Navigate to the file to be imported and choose it. The **Import PAC** dialog displays.

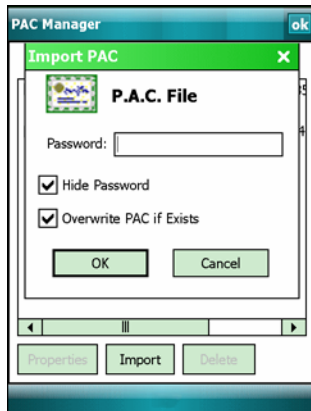

**Figure 2-96** *Import PAC Dialog Box*

If the PAC file is password protected, enter the password in the *Password* field. If you clear the *Hide Password* check box, the password is displayed in clear text as you type it. To hide the password as you type it, leave the *Hide Password* check box selected. If you wish to overwrite any existing PAC in the Fusion PAC Store without being prompted for verification, select the *Overwrite PAC if Exists* check box. Select the **Ok** button to import the PAC. Select the **Cancel** button to abort the import operation.

If you selected **ok** and the PAC already exists in the PAC Store, a verification dialog box may appear. Select *Yes* to continue the import operation or select *No* to abort the operation. If selected *Yes*, an informational dialog box appears listing the attributes (A-ID and I-ID) of the imported PAC.

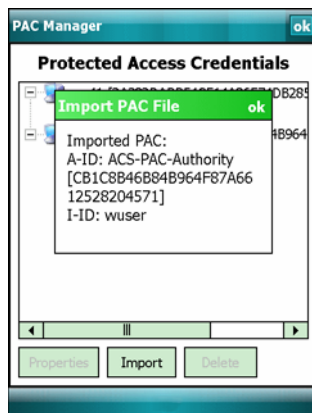

**Figure 2-97** *Import PAC File Dialog Box*

Select **Ok** to close the dialog box and return to the main *PAC Manager* screen with the tree list of PACs. The newly-imported PAC should appear in the list.

## Options

Use the *Wireless Options* dialog to select one of the following operation options from the drop-down list:

- Operating Mode (Op Mode) Filtering
- Regulatory
- Band Selection
- System Options
- Auto PAC Settings
- Change Password
- Export.

### **Operating Mode Filtering**

The Operating Mode Filtering options cause the Find WLANs application to filter the available networks found.

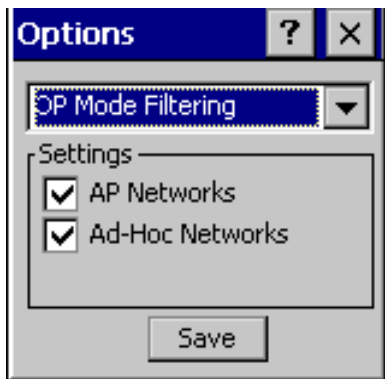

**Figure 2-98** *OP Mode Filtering Dialog Box*

The *AP Networks* and *Ad-Hoc Networks* check boxes are selected by default.

**Table 2-19** *OP Mode Filtering Options*

Field	Description
AP Networks	Select the <i>AP Networks</i> check box to display available AP networks and their signal strength within the Available WLAN Networks (see <a href="#">Find WLANs on page 2-42</a> ). These are the APs in the vicinity available to the device for association. If this option was previously disabled, refresh the Available <i>WLAN Networks</i> screen to display the AP networks available to the device.
AD-Hoc Networks	Select the <i>Ad-Hoc Networks</i> check box to display available peer (adapter) networks and their signal strength within the Available WLAN Networks. These are peer networks in the vicinity that are available to the device for association. If this option was previously disabled, refresh the Available <i>WLAN Networks</i> screen to display the Ad Hoc networks available to the device.

Select *Save* to save the settings or select *X* to discard any changes.



### Regulatory Options

Use the Regulatory settings to configure the country the device is in. Due to regulatory requirements (within a country) a device is only allowed to use certain channels.



Figure 2-99 Regulatory Options Dialog Box

Table 2-20 Regulatory Options

Field	Description
Settings	Select a country from the drop-down list. If the <i>Enable 802.11d</i> check box is not selected, a profile's country selection must match this setting in order to connect to that profile.
Enable 802.11d	If the Enable 802.11d check box is selected, the WLAN adapter follows the 802.11d standard. It passively scans until valid country information is received from an AP. It limits transmit power settings based on maximums received from the AP.  Profiles which use Infrastructure mode can only connect if the country selected in the profile matches the AP country setting or if the profile country setting is Allow Any Country. Profiles which use Ad-hoc mode are not 802.11d compliant.

### Band Selection

The *Band Selection* settings identify the frequency bands to scan when finding WLANs. These values refer to the 802.11 standard networks.



Figure 2-100 Band Selection Dialog Box

- ✓ **NOTE** Select one band for faster access when scanning for WLANs.  
Not all devices support both 2.4 GHz and 5 GHz bands.

**Table 2-21** *Band Selection Options*

Field	Description
2.4GHz Band	The Find WLANs application list includes all networks found in the 2.4 GHz band (802.11b and 802.11g).
5GHz Band	The Find WLANs application list includes all networks found in the 5 GHz band (802.11a).

Select Save to save the settings or select X to discard any changes.

### **System Options**

Use System Options to set miscellaneous system setting.

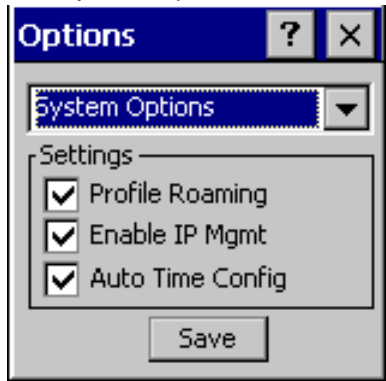
**Figure 2-101** *System Options Dialog Box*

### **Auto PAC Settings**

**Table 2-22** *System Options*

Field	Description
Profile Roaming	Configures the device to roam to the next available WLAN profile when it moves out of range of the current WLAN profile.
Enable IP Mgmt	Enables the Wireless Companion Services to handle IP address management. The Wireless Companion Service configures the IP based on what is configured in the network profile. Deselect this to manually configure the IP in the standard <i>Windows IP</i> screen. Enabled by default.
Auto Time Config	Enables automatic update of the system time. Network association updates the device time based on the time set in the AP. This proprietary feature is only supported with Zebra infrastructure. Enabled by default.

Use the Auto PAC Settings to configure whether to allow automatic PAC provisioning and automatic PAC refreshing when using the EAP-FAST authentication protocol.

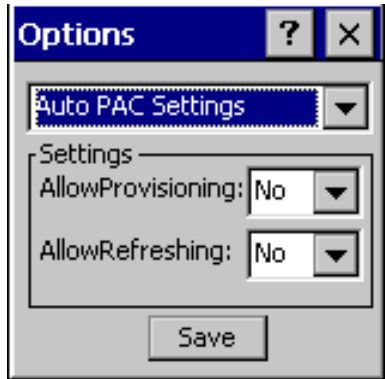

Figure 2-102 Auto PAC Settings Dialog Box

Table 2-23 Auto PAC Settings

Field	Description
Allow Provisioning	Select Yes from the drop-down list to allow the terminal to be automatically provisioned with a PAC when using the EAP-FAST authentication protocol. Select No to disallow automatic PAC provisioning.
Allow Refreshing	Select Yes from the drop-down list to allow an existing PAC on the terminal to be automatically refreshed when using the EAP-FAST authentication protocol. Select No to disallow automatic PAC refreshing.

If the master key expired, the PAC on the device that was generated with this expired key must be manually deleted and a new PAC provisioned even when “Allow Refreshing” is turned ON.

**Change Password**

Use *Change Password* to require that a user enter a password before being allowed to create or edit a profile or change the Options. This allows pre-configuring profiles and prevents users from changing the network settings. The user can use this feature to protect settings from a guest user. By default, the password is not set.

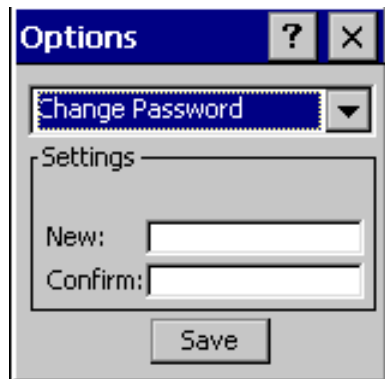

Figure 2-103 Change Password Screen

Enter the current password in the Current text box. If there is no current password, the *Current* text box is not displayed. Enter the new password in the *New:* and *Confirm:* text boxes. Select *Save*.

To change an existing password, enter the current password in the *Current* text box and enter the new password in the *New:* and *Confirm:* text boxes. Select *Save*.

To delete the password, enter the current password in the *Current:* text box and leave the *New:* and *Confirm:* text boxes empty. Select *Save*.



**NOTE** Passwords are case sensitive and can not exceed 63 characters.

## Export

- ✓ **NOTE** For Windows CE 5.0 devices, exporting options enables settings to persist after a cold boot.

Use Export to export all profiles to a registry file and to export the options to a registry file.

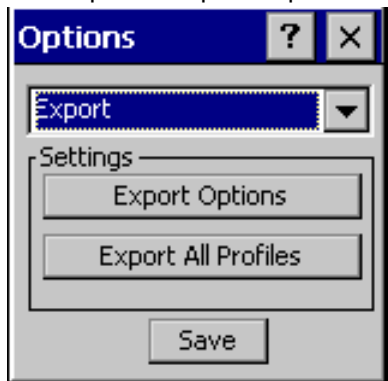

**Figure 2-104** Export Dialog Box

To export options:

1. Select *Export Options*. The *Save As* dialog displays.



**Figure 2-105** Export Options Save As Dialog Box

2. Enter a filename in the *Name:* field. The default filename is *WCS\_OPTIONS.REG*.
3. Select the desired folder.
4. Select *Save*.

To export all profiles:

1. Select *Export All Profiles*. The *Save As* dialog displays.



**Figure 2-106** *Export All Profiles Save As Dialog Box*

2. Enter a filename in the *Name:* field. The default filename is *WCS\_PROFILES.REG*.
3. In the *Folder:* drop-down list, select the desired folder.
4. Select *Save*.

Selecting *Export All Profiles* also saves an indication of the current profile. This information is used to determine which profile to connect with after a warm boot or cold boot.

## Wireless Status

To open the *Wireless Status* screen, select *Wireless Status* from the *Wireless Companion* menu. The *Wireless Status* screen displays information about the wireless connection.

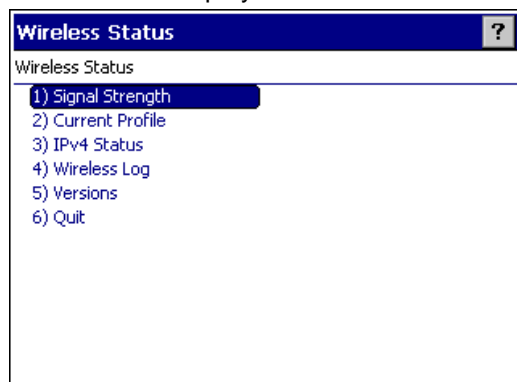

**Figure 2-107** *Wireless Status Screen*

The *Wireless Status* screen contains the following options. Select the option to display the option screen.

- **Signal Strength:** Provides information about the connection status of the current wireless profile.
- **Current Profile:** Displays basic information about the current profile and connection settings.
- **IPv4 Status:** Displays the current IP address, subnet and other IP related information assigned to the device.
- **Wireless Log:** Displays a log of important recent activity, such as authentication, association and DHCP renewal completion, in time order.

- Versions: Displays software, firmware and hardware version numbers.
- Quit: Exits the *Wireless Status* screen.

Each option screen contains a back button  to return to the main *Wireless Status* screen.

### Signal Strength

The *Signal Strength* screen provides information about the connection status of the current wireless profile including signal quality, missed beacons and other statistics described below. The BSSID address (shown as AP MAC Address) displays the AP currently associated with the connection. In Ad-Hoc mode, the AP MAC Address shows the BSSID of the Ad-Hoc network. Information in this screen updates every 2 seconds.

To open the *Signal Status* screen, select *Signal Strength* in the *Wireless Status* screen.

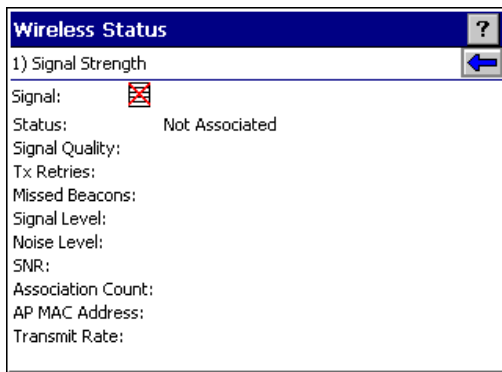







**Figure 2-108** *Signal Strength Screen*

After viewing the *Signal Strength* screen, select the back button to return to the *Wireless Status* screen.

### Current Profile

**Table 2-24** *Signal Strength Status*

Field	Description
Signal	<p>Displays the Relative Signal Strength Indicator (RSSI) of the signal transmitted between the AP and device. As long as the Signal Quality icon is green the AP association is not jeopardized. If the icon is red (poor signal), an association with a different AP could be warranted to improve the signal. The signal strength icon changes depending on the signal strength.</p> <ul style="list-style-type: none"> <li> Excellent Signal</li> <li> Very Good Signal</li> <li> Good Signal</li> <li> Fair Signal</li> <li> Poor Signal</li> <li> Out of Range (no signal)</li> </ul>
Status	Indicates if the device is associated with the AP.
Signal Quality	Displays a text format of the Signal icon.

**Table 2-24** *Signal Strength Status (Continued)*

Field	Description
Tx Retries	Displays a percentage of the number of data packets the device retransmits. The fewer transmit retries, the more efficient the wireless network is.
Missed Beacons	Displays a percentage of the amount of beacons the device missed. The fewer missed beacons, the more efficient the wireless network is. Beacons are uniform system packets broadcast by the AP to keep the network synchronized.
Signal Level	The AP signal level in decibels per milliwatt (dBm).
Noise Level	The background interference (noise) level in decibels per milliwatt (dBm).
SNR	The access point/device Signal to Noise Ratio (SNR) of signal strength to noise (interference) in decibels per milliwatt (dBm).
Association Count	Displays the number of times the device has roamed from one AP to another.
AP MAC Address	Displays the MAC address of the AP to which the device is connected.
Transmit Rate	Displays the current rate of the data transmission.

The *Current Profile* screen displays basic information about the current profile and connection settings. This screen updates every two seconds.

To open the *Current Profile* screen, select *Current Profile* in the *Wireless Status* screen.

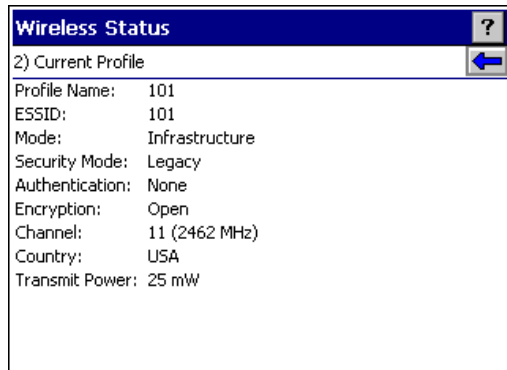
**Figure 2-109** *Current Profile Screen***Table 2-25** *Current Profile Screen*

Field	Description
Profile Name	Displays the name of the profile that the device is currently using to communicate with the AP.
ESSID	Displays the current profile's ESSID.
Mode	Displays the current profile's mode, either Infrastructure or Ad-Hoc. See <a href="#">Operating Mode on page 2-44</a> .
Security Mode	Displays the current profile's security mode. See <a href="#">Table 2-7 on page 2-48</a> .
Authentication	Displays the current profile's authentication type. See <a href="#">Table 2-8 on page 2-49</a> .
Encryption	Displays the current profile's encryption type. See <a href="#">Table 2-11 on page 2-61</a> .



**Table 2-25** Current Profile Screen (Continued)

Field	Description
Channel	Displays the channel currently being used to communicate with the AP.
Country	Displays the country setting currently being used.
Transmit Power	Displays the current radio transmission power level. See <a href="#">Table 2-17 on page 2-68</a> .

### IPv4 Status

The *IPv4 Status* screen displays the current IP address, subnet and other IP related information assigned to the device. It also allows renewing the IP address if the profile is using DHCP to obtain the IP information. Select Renew to initiate the IP address renewal process. The *IPv4 Status* screen updates automatically when the IP address changes.

To open the *IPv4 Status* screen, select *IPv4 Status* in the *Wireless Status* screen.

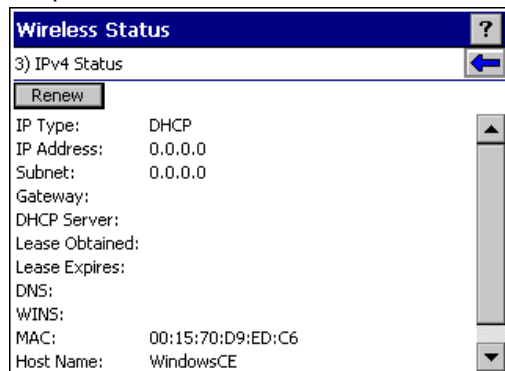
**Figure 2-110** IPv4 Status Screen

**Table 2-26** IPv4 Status Fields

Field	Description
IP Type	Displays the IP address assignment method used for the current profile: DHCP or Static. If the IP Type is DHCP, the IP Address and other information shown is obtained from the DHCP server. In this case, the DHCP Server address and the Lease information is also shown. If the IP Type is Static, the IP Address and other information shown are those that were entered in the profile.
IP Address	Displays the device's IP address. The Internet is a collection of networks with users that communicate with each other. Each communication carries the address of the source and destination networks and the particular machine within the network associated with the user or host computer at each end. This address is called the IP address. Each node on the IP network must be assigned a unique IP address that is made up of a network identifier and a host identifier. The IP address is shown in dotted-decimal notation with the decimal value of each octet separated by a period, for example, 192.168.7.27.
Subnet	Displays the device's subnet mask. Most TCP/IP networks use subnets to manage routed IP addresses. All IP addresses have a network part and a host part. The network part specifies a physical network. The host part specifies a host on that physical network. The subnet mask allows a network administrator to use some of the bits that are normally used to specify the host to instead specify physical sub-networks within an organization. This helps organize and simplify routing between physical networks.
Gateway	Displays the gateway address. A gateway forwards IP packets to and from a remote destination.
DCHP Server	Displays the IP address of the DHCP server.

**Table 2-26** IPv4 Status Fields (Continued)

Field	Description
Lease Obtained	Displays the date and time that the IP address was obtained.
Lease Expires	Displays the date and time that the IP address expires.
DNS	Displays the IP address of the DNS server.
WINS	WINS is a Microsoft Net BIOS name server. WINS eliminates the broadcasts needed to resolve computer names to IP addresses by providing a cache or database of translations.
MAC	The IEEE 48-bit address is assigned to the device at the factory to uniquely identify the adapter at the physical layer.
Host Name	Displays the name of the device.

### Wireless Log

The *Wireless Log* screen displays a log of recent activity, such as authentication, association and DHCP renewal completion, in time order. Save the log to a file or clear the log. The auto-scroll feature automatically scrolls down when new items are added to the log.

To open the *Wireless Log* screen, select Wireless Log in the *Wireless Status* screen. The *Wireless Log* screen displays.

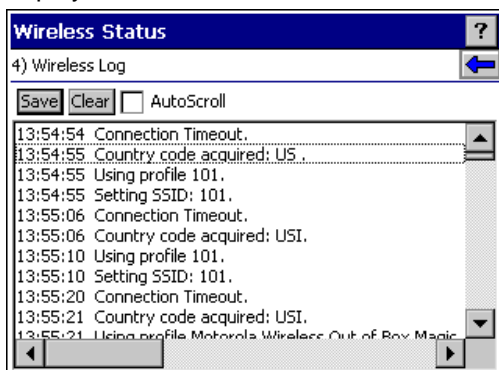
**Figure 2-111** Wireless Log Screen

### Saving a Log

To save a Wireless Log:

1. Select Save. The Save As dialog displays.
2. Navigate to the desired folder.
3. In the *Name:* field, enter a file name and then select OK. The *Wireless Log* is saved as a text file in the selected folder.

## Clearing the Log

To clear the log, select *Clear*.

## Versions

The *Versions* screen displays software, firmware and hardware version numbers. To open the *Versions* screen, select *Versions* in the *Wireless Status* screen.

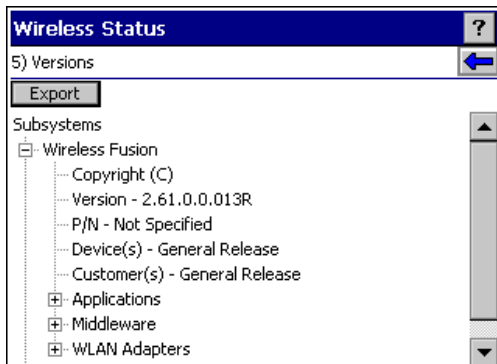
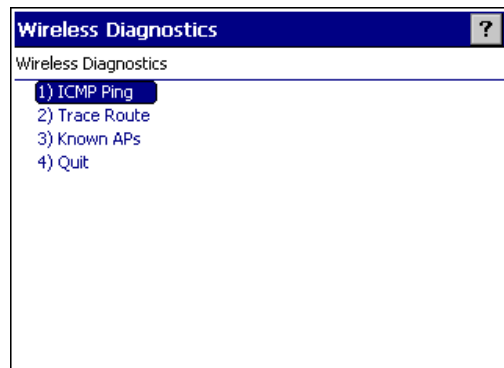

**Figure 2-112** *Versions Screen*

The screen displays Fusion software version numbers as well as application and middleware version information.

## Wireless Diagnostics

The *Wireless Diagnostics* screen provides links to perform ICMP Ping, Trace Routing and Known APs functions. To open the *Wireless Diagnostics* screen, select *Wireless Diagnostics* from the *Wireless Companion* menu.



**Figure 2-113** *Wireless Diagnostics Screen*

The *Wireless Diagnostics* option screen contains the following options. Select the option to display the option screen.

- ICMP Ping: Tests the wireless network connection.
- Trace Route: Tests a connection at the network layer between the device and any place on the network.
- Known APs: Displays the APs in range using the same ESSID as the device.
- Quit: Exits the *Wireless Diagnostics* screen.

Each of the *Wireless Diagnostics* option screens includes a back button  to return to the *Wireless Diagnostics* screen.

## ICMP Ping

The *ICMP Ping* screen allows testing of a connection at the network layer (part of the IP protocol) between the device and any other device on the network. Ping tests only stop when *Stop Test* is selected, the *Wireless Diagnostics* application is closed or if the device switches between infrastructure and ad-hoc modes.

To open the *ICMP Ping* screen, select *ICMP Ping* in the *Wireless Diagnostics* screen.

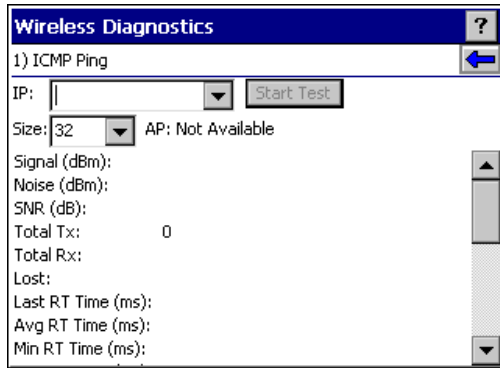

**Figure 2-114** ICMP Ping Screen

To perform an ICMP ping:

1. In the *IP* field, enter an IP address or select an IP address from the drop-down list.
2. From the *Size* drop-down list, select a size value.
3. Select *Start Test*. The ICMP Ping test starts. Information of the ping test displays in the appropriate fields. The following statistics appear on the page:
  - **Signal:** The current signal strength, measured in dBm, is provided both as a numerical value and as a histogram.
  - **Noise:** The current noise level, measured in dBm, is provided both as a numerical value and as a histogram.
  - **SNR:** The current signal to noise ratio, measured in dBm, is provided both as a numerical value and as a histogram.
  - **Total Tx:** The total number of pings sent is displayed numerically.
  - **Total Rx:** The total number of valid ping responses received is displayed numerically.
  - **Lost:** The total number of pings that were lost is displayed numerically.
  - **RT Times:** Four round trip times: Last, Average, Minimum and Maximum are displayed in milliseconds.
  - **% Rates:** For each of the 12 data rates, the number of times that rate was used to transmit the ping is displayed as a percentage.

## Graphs

A real time graph of any of the above statistics can be displayed by pressing *ENT* on the statistic.

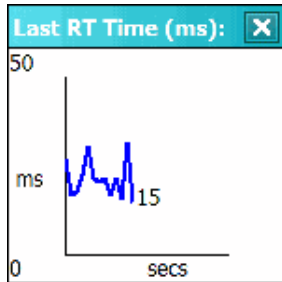

**Figure 2-115** Graph Example

## Trace Route

*Trace Route* traces a packet from a computer to a host, showing how many hops the packet requires to reach the host and how long each hop takes. The *Trace Route* utility identifies where the longest delays occur.

The *Trace Route* screen allows testing a connection at the network layer (part of the IP protocol) between the device and any other device on the network.

To open the *Trace Route* screen, select *Trace Route* in the *Wireless Diagnostics* screen.

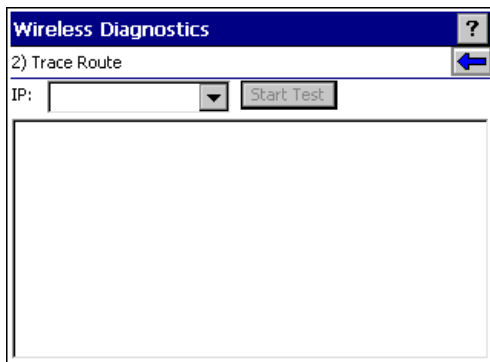
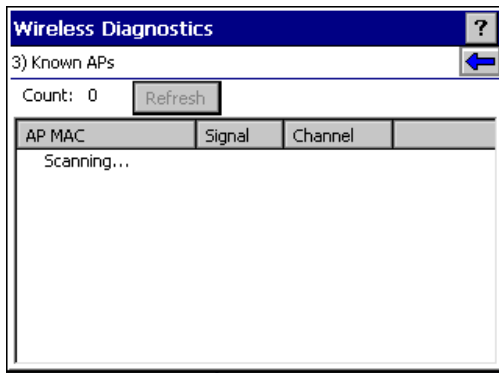

**Figure 2-116** Trace Route Screen

In the IP combo box, enter an IP address or choose one from the drop-down list or enter a DNS Name and select Start Test. When starting a test, the trace route attempts to find all routers between the device and the destination. The Round Trip Time (RTT) between the device and each router appears, along with the total test time. The total test time may be longer than all RTTs added together because it does not only include time on the network.

### Known APs

The *Known APs* screen displays the APs in range using the same ESSID as the device. This screen is only available in Infrastructure mode. To open the *Known APs* screen, select *Known APs* in the *Wireless Diagnostics* screen.



**Figure 2-117** *Known APs Screen*

[Table 2-27](#) includes the definitions of the icons next to the AP.

**Table 2-27** *Current Profile Screen*

Icon	Description
	The AP is the associated access point and is set to mandatory.
	The AP is the associated access point, but is not set to mandatory.
	The device is not associated to this AP, but the AP is set as mandatory.
	The device is not associated to this AP and the AP is not set as mandatory.

Select an AP to display a pop-up menu with the following options: Set Mandatory and Set Roaming.

Select Set Mandatory to prohibit the device from associating with a different AP. The letter M displays on top of the icon. The device connects to the selected AP and never roams until:

- Set Roaming is selected.
- Set Mandatory is selected on a different AP.
- Manually connecting to a profile from the *Manage Profiles* page.
- The device roams to a new profile.
- The device resets (warm or cold).

Select Set Roaming to allow the device to roam to any AP with a better signal. These settings are temporary and never saved to the registry.

Select Refresh to update the list of the APs with the same ESSID.

## Log On/Off

When the user selects Log On/Off, the device may be in one of two states; the user may be logged onto the device by already entering credentials through the login box or there is no user logged on. Each of these states has a separate set of use cases and a different look to the dialog.

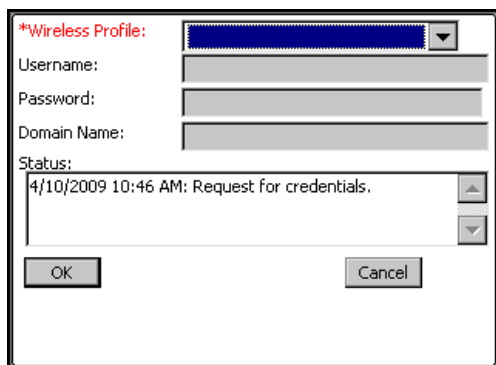

Figure 2-118 Log On/Off Screen

### User Already Logged In

If already logged into the device, the user can launch the login dialog for the following reasons:

- Connect to a different profile.
- Connect to and re-enable a cancelled profile. To do this:
  - Launch the *Log On/Off* dialog.
  - Select the cancelled profile from the profile drop-down list.
  - Login to the profile.

✓ **NOTE** A cancelled profile can also be re-enabled by using the *Manage Profile* screen to connect to the cancelled profile.

- Log off the device to prevent another user from accessing the current users network privileges.
- Switch device users to quickly logoff the device and allow another user to log into the device.

### No User Logged In

If no user is logged into the device, launch the login dialog and log in to access user profiles.

The *Login* dialog varies if it is:

- Launched by WCS, because the service is connecting to a new profile that needs credentials.
- Launched by WCS, because the service is trying to verify the credentials due to credential caching rules.
- Launched by a user, when a user is logged in.
- Launched by a user, when no user is logged in.

**Table 2-28** Log On/Off Options

Field	Description
Wireless Profile Field	When launching the login application, the <i>Wireless Profile</i> field has available all the wireless profiles that require credentials. This includes profiles that use EAP TLS, PEAP, LEAP, EAP-TTLS or EAP-FAST.
Profile Status Icon	The profile status icon (next to the profile name) shows one of the following states: <ul style="list-style-type: none"> <li>• The selected profile is cancelled.</li> <li>• The selected profile is enabled but is not the current profile.</li> <li>• The profile is the current profile (always the case for WCS Launched).</li> </ul>
Username, Password and Domain Name Fields	The <i>Username</i> , <i>Password</i> and <i>Domain Name</i> fields are used as credentials for the profile selected in the <i>Wireless Profile</i> field. The <i>Password</i> field is limited to 63 characters. The <i>Username</i> and <i>Domain Name</i> fields combined are limited to 63 characters. Note if any of the above field labels are red, then entry is mandatory; if the field labels are black, then entry is optional.
Mask Password Check box	The <i>Mask Password</i> check box determines whether the <i>password</i> field is masked (i.e., displays only the 1*1 character) or unmasked (i.e., displays the entered text). Check the box to unmask the password. Uncheck the box to mask the password (the default).
Status Field	The <i>status</i> field indicates the reason the dialog is open.

Selecting *OK* sends the credentials to the WCS. If there are no credentials entered, a dialog displays asking the user to fill in all required fields.

*Log Off* only displays when a user is already logged on. When *Log Off* is selected, the user is prompted with three options: *Log Off*, *Switch Users* and *Cancel*. Switching users logs off the current user and re-initialize the login dialog to be displayed for when there is no user logged on.

Logging off logs off the current user and close the login dialog. Selecting *Cancel* closes the *Log Off* dialog and returns to the *Login* dialog.

When the user is logged off, the device only roams to profiles that do not require credentials or to profiles that were created with the credentials entered into the profile. Selecting *Cancel* closes the dialog without logging into the network. If the login dialog was launched by the WCS and not by the user, selecting *Cancel* first causes a message box to display a warning that the cancel disables the current profile. If the user still chooses to cancel the login at this point, the profile is cancelled.

Once a profile is cancelled, the profile is suppressed until a user actively re-enables it or a new user logs onto the device.

### Enable/Disable Radio

On the *Wireless Companion* menu, press the up or down *Scroll* key to highlight *Enable* or *Disable Radio* and press *ENT*. The radio is enabled or disabled, depending on its current state.



### Settings

The *Settings* screen allows the user to set bar code parameters on the device.

To access *Settings* from the *Home* screen, select *Config... > Scanner Settings*. Use the keypad to navigate through *General Parameters* and *Barcode Settings* to set the appropriate environment for the device.

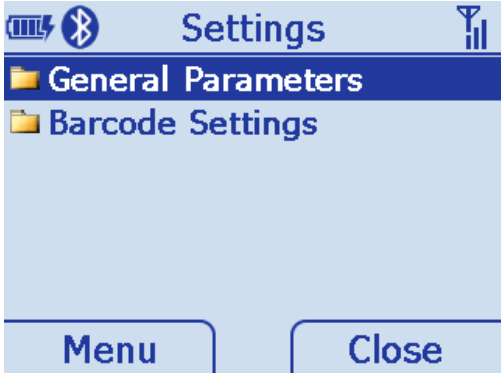

Figure 2-119 Settings Screen

### General Parameters

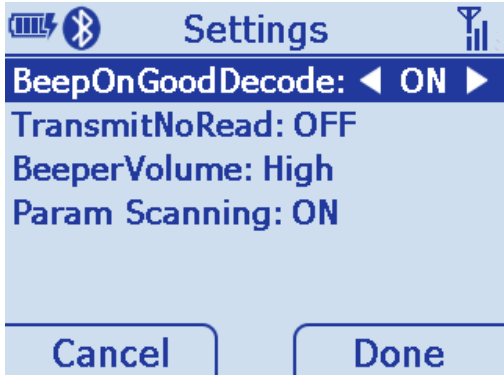

Figure 2-120 General Parameters Screen

### Bar Code Settings

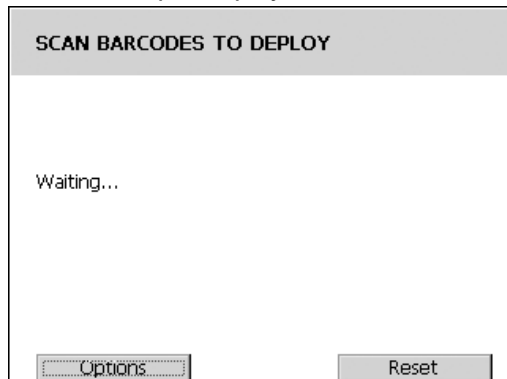

Figure 2-121 Bar Code Settings Screen

## Rapid Deployment

The Rapid Deployment (RD) Client facilitates software downloads to a device from a Mobility Services Platform (MSP) Console's FTP server. This task is generally performed by the system administrator, or integrator. For more information, refer to the *MT2070/MT2090 Integrator Guide*.

To access *Rapid Deployment* from the *Home* screen, select *Config... > Rapid Deployment*.



**Figure 2-122** *Rapid Deployment Screen*

## MSP Agent

Zebra's Services Platform 3 (MSP 3) is a scalable software solution that provides a single point of control for managing large numbers of devices within an enterprise. MSP 3 consists of a server-based software product and a set of device-resident software components collectively called the MSP 3 Client software which enable the management of devices.

Used together, these software components allow you to perform the following tasks:

- Staging
- Provisioning
- Asset Management
- Data Collection and Analysis.

This task is generally performed by the system administrator, or integrator. For more information, refer to the *MT2070/MT2090 Integrator Guide*.

To access *MSP Agent* from the *Home* screen, select *Config... > MSP Agent*.

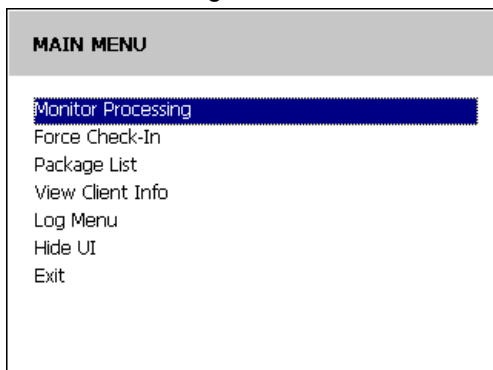

**Figure 2-123** *MSP Agent Screen*

## BTE Explorer

BTE Explorer is used to configure Bluetooth services and settings as well as to establish connections to other Bluetooth devices.

✓ **NOTE** ADCServices must be disabled in order to use BTE Explorer.

To launch BTE Explorer:

1. From the main menu, navigate to and select *Config ...*.
2. Select *BTE Explorer*. If a previous connection was established, the Favorites window displays (see [Figure 2-128 on page 2-97](#)).

If no previous connections were established, the following window displays the *New Connection Wizard*.



**Figure 2-124** BTE Explorer - New Connection Wizard Screen

### Establish a New Connection

The *Wizard* provides a simple step-by-step process to discover and connect to Bluetooth devices.

To discover services on a remote device and establish a serial port connection:

1. On the *New Connection Wizard* window ([Figure 2-124](#)), use the keypad and select one of the following service options from the drop-down list:
  - Explore Service on Remote Device
  - Pair with Remote Device
  - Active Sync via Bluetooth
  - Browse Files on Remote Device
  - Connect to Printer
  - Send or Exchange Objects
  - Associate Serial Port.

✓ **NOTE** If you select *Active Sync via Bluetooth*, ensure that the Bluetooth software is set up properly on the host device.

2. Select *Next*. Depending on the service selected in [Figure 2-124](#), *BTE Explorer* discovers devices in range and selects devices that provide the service selected.



**Figure 2-125** *New Connection Wizard, Select Remote Device Screen*

3. Select *Next* in [Figure 2-125](#). Select COM7 as the desired service.

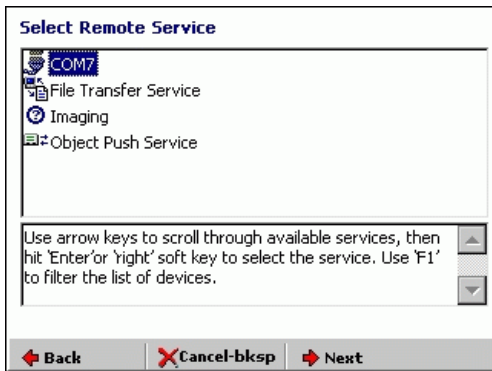

**Figure 2-126** *New Connection Wizard, Select Remote Service Screen*

4. Select *Next* in [Figure 2-126](#). A *Connection Summary* window displays.

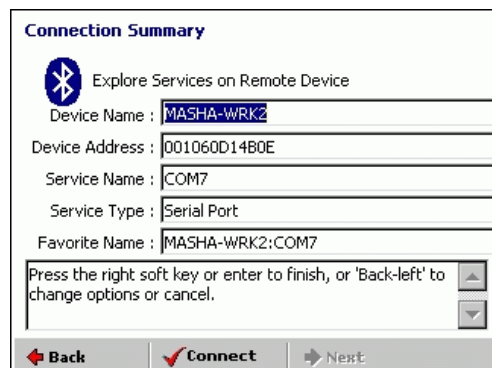

**Figure 2-127** *New Connection Wizard, Connection Summary Screen*

- When the wizard completes, a connection is automatically saved in favorites and the *Favorites* window displays.

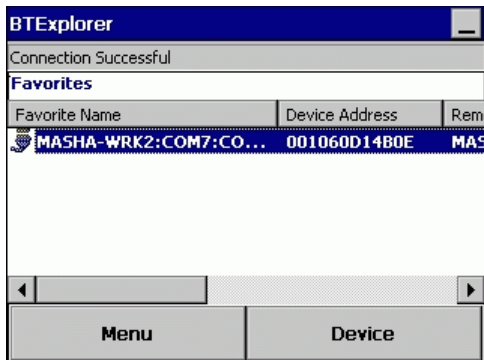

**Figure 2-128** *New Connection Wizard, Favorites Screen*

### Add a Bluetooth Service

The following Bluetooth services can be added:

- Serial Port
- File Transfer
- OBEX: Object Exchange.

To add a Bluetooth service:

- On the *Favorites* window ([Figure 2-128](#)), use the keypad and select *Device > Settings > Services*.

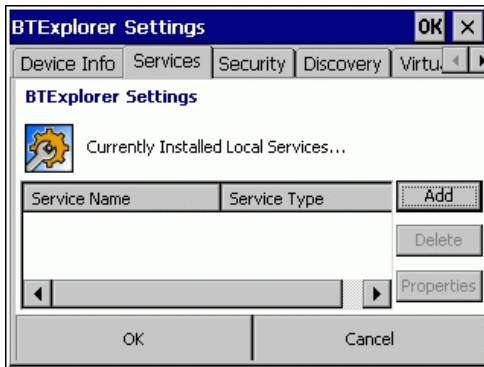

**Figure 2-129** *BTE Explorer Settings Screen*

2. Select **Add** in [Figure 2-129](#) and choose a service from the list.

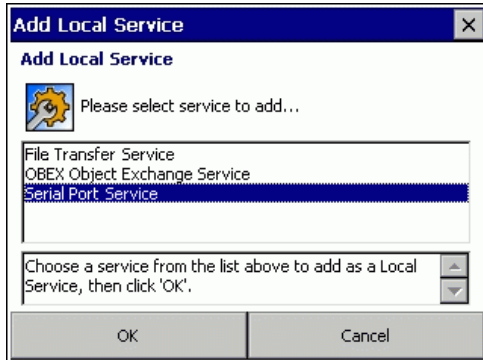

**Figure 2-130** Add Local Service Screen

3. In this example, *Serial Port Service* is chosen. Click **OK**.
4. *Serial Port Service* is added to the list.

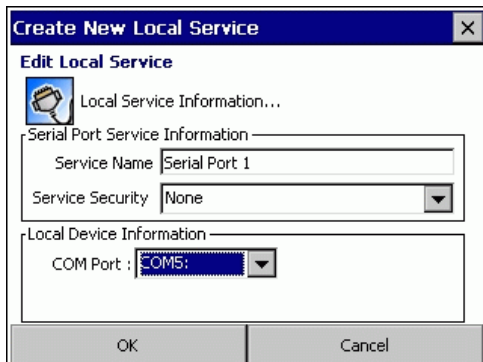

**Figure 2-131** Edit Local Service Screen

5. Update the fields in the Edit window as needed. Click **OK**.
6. *Serial Port Service* is added to the list.

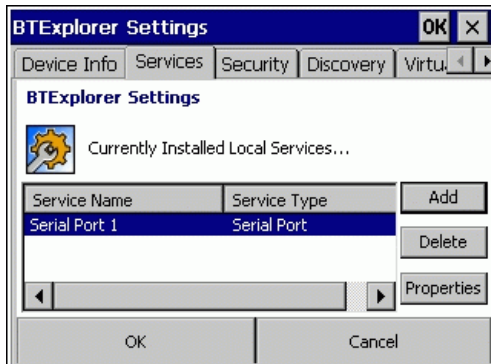

**Figure 2-132** BTE Explorer Settings Screen

## Turn Bluetooth On/Off

To turn the Bluetooth radio off:

Open the *BTEplorer* application to display the *Favorites* window ([Figure 2-128](#)).

*Home screen > Config... > BTEplorer > Device > Disable Bluetooth.*

To turn the Bluetooth radio on:

Open the *BTEplorer* application to display the *Favorites* window ([Figure 2-128](#)).

*Home screen > Config... > BTEplorer > Device > Enable Bluetooth.*

## Miscellaneous Bluetooth Settings

### Device Info Tab

On the *Favorites* window ([Figure 2-128](#)), use the keypad and select *Device > Settings > Device Info*.

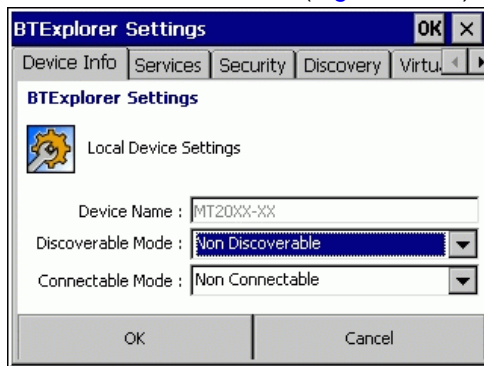

**Figure 2-133** Bluetooth Settings - Device Info Screen

Use the *Device Info* tab to configure the following Bluetooth connection modes.

- *Device Name*: Displays the name of the device.
- *Discoverable Mode*: Select whether or not the device is discoverable by other Bluetooth devices.
- *Connectable Mode*: Select whether or not the device is connectable by other Bluetooth devices.

### Services Tab

See [Add a Bluetooth Service on page 2-97](#).

### Security Tab

On the *Favorites* window ([Figure 2-128](#)), use the keypad and select *Device > Settings > Security*.

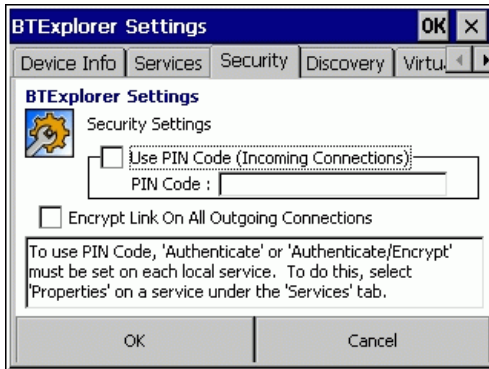

**Figure 2-134** Bluetooth Settings - Security Screen

To adjust the security settings for an individual service:

1. Select the *Services* tab (see [Figure 2-130 on page 2-98](#)).
2. Select a service.
3. Select *Properties*.
4. Select *PIN Code (Incoming Connection)* for automatic use of the PIN code entered in the *PIN Code* text box. It is not recommended to use this automatic PIN code feature.
5. Select *Encrypt Link On All Outgoing Connections* to enable or disable encryption. Use encryption whenever possible.

### Discovery Tab

On the *Favorites* window ([Figure 2-128](#)), use the keypad and select *Device > Settings > Discovery*.

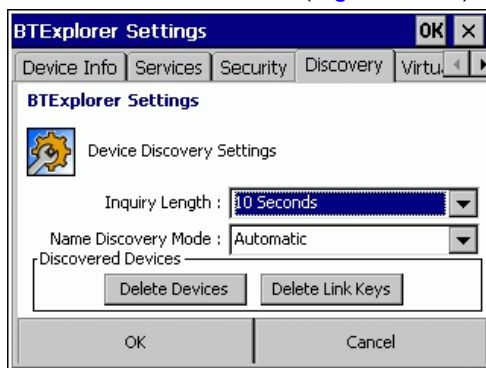

**Figure 2-135** Bluetooth Settings - Discovery Screen

To set and modify discovered devices:

1. Tab to *Inquiry Length* to set the amount of time the device takes to discover Bluetooth devices in the area.
2. Tab to *Name Discovery Mode*: and select either *Automatic* or *Manual*. (Discovers the friendly name of the remote device as opposed to the address.)



3. Tab to and select **Delete Devices** and/or **Delete Link Keys** to delete all discovered devices and link keys.

✓ **NOTE** To force BTE Explorer to re-discover devices in the area, select **Delete Devices**.

**Virtual COM Port Tab**

On the *Favorites* window (Figure 2-128), use the keypad and select *Device > Settings > Virtual COM Port*.

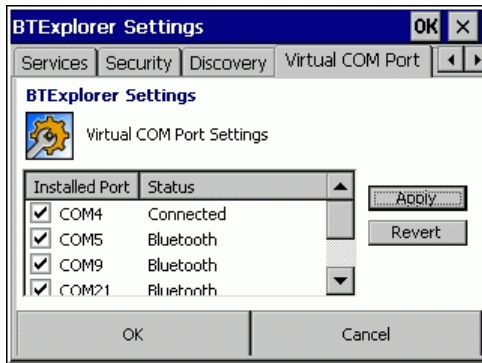

**Figure 2-136** Bluetooth Settings - Virtual COM Port Screen

To select the COM ports for Bluetooth communication, select the appropriate *Installed Port*.

- COM4: Bluetooth enable or disable COM Port 4.
- COM5: Bluetooth enable or disable COM Port 5
- COM9: Bluetooth enable or disable COM Port 9
- COM21: Bluetooth enable or disable COM Port 21
- COM23: Bluetooth enable or disable COM Port 23.

**Profiles Tab**

On the *Favorites* window (Figure 2-128), use the keypad and select *Device > Settings > Profiles*.

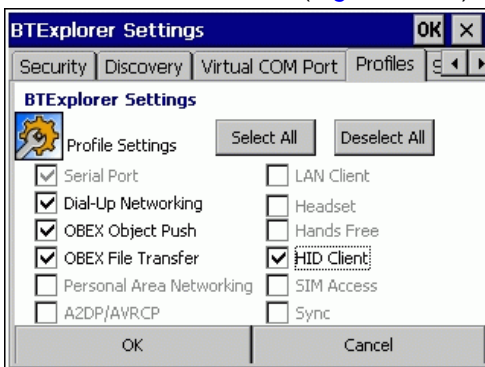

**Figure 2-137** Bluetooth Settings - Profiles Screen

The device is loaded with a number of Bluetooth services profiles. These profiles can be loaded or removed from memory. If a profile is not used, it can be removed to save memory.

To load or remove profiles:

1. Navigate to a check box next to the profile.
2. Press the orange key on the keypad and press the *Space* key to select/clear the check box.

✓ **NOTE** The Serial Port profile is always active and cannot be removed.

3. Use the *Tab* key to navigate to **Select All** (select all profiles) or **Deselect All** (deselect all profiles) and press *ENT*.

### Configure USB

This utility is used to configure the USB protocol which runs when a USB cable is attached to the MT20X0 or STB2078 cradle. An asterisk (\*) appears next to the selection indicates the current setting.

✓ **NOTE** ActiveSync, SNAPI, SNAPI with imaging apply only to the MT20X0. If selected and paired to the cradle, HID keyboard is used.

Retail CDC only applies to the STB2078 cradle. If selected and a USB cable is directly connected to the MT20X0, ActiveSync is installed.

When configured in ActiveSync, decode data is not transmitted after a scan and an error beep (four beeps) sound.

To access *USB Config*, start at the *Home* screen, scroll to *Config...*

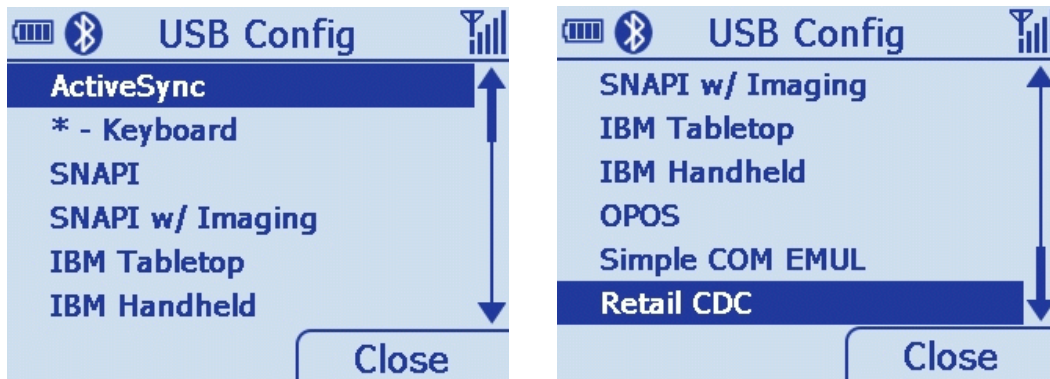

Figure 2-138 Configure USB Screen

Table 2-29 Configure USB - Option Descriptions

USB Configuration	Description
ActiveSync	Configures the device to use ActiveSync on device only. <b>Note:</b> If connecting ActiveSync via USB, it is recommended you use an ESD dongle with the USB cable. (ESD part numbers KT-8830-03R -3 piece kit, or KT-8830-10R - 10 piece kit.)
Keyboard	Configures the device to use HID Keyboard Emulation on the device and cradle.
SNAPI	Configures the device to use the SNAPI protocol on device only.

**Table 2-29** *Configure USB - Option Descriptions (Continued)*

USB Configuration	Description
SNAPI w/Imaging	Configures the device to use the SNAPI protocol with imaging on device only.
IBM Tabletop	Configures the device to use the IBM tabletop protocol on both device and cradle.
IBM Handheld	Configures the device to use the IBM Handheld protocol on both device and cradle.
OPOS	Configures the device to use the OPOS / JPOS protocol on both device and cradle.
Simple COM Emul	Configures the device to use the Legacy Symbol COM port emulation protocol on both device and cradle.
Retail CDC	Configures the device to use the new Communication Device Class COM port emulation which supports Beep on BEL on cradle only.

## Up

Highlight *0 - Up* and press *ENT* to return to the *Home* screen.

## Menu

The *Config* screen menu has the same functionality as the *Home* screen menu providing access to *User Settings*, *Device Status*, *Battery Status* and an *About* screen.

Press the left soft key to display the *Config* screen menu; press the up or down *Scroll* key to select an option; press *ENT* to display the appropriate screen.

Press *TAB* to exit the menu and return to the *Config* screen.

See [Menu on page 2-12](#) for detailed information about menu options.

## Utilities

To access *Utilities*, start at the *Home* screen, scroll to *Utilities...* and press *ENT*. The *Utilities* screen displays.

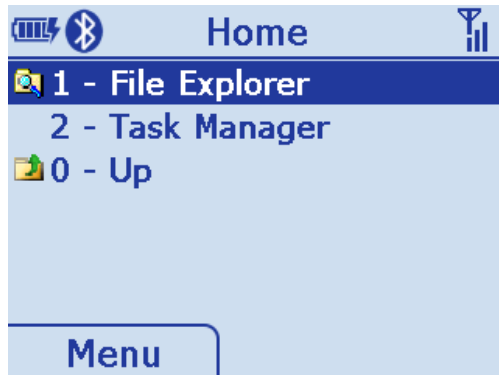

Figure 2-139 Utilities Screen

Within the utilities submenu, the following programs are available for use by developers and integrators:

- File Explorer
- Task Manger.

## File Explorer

Scroll to *File Explorer* on the *Utilities* screen and press *ENT* to display the *File Explorer* screen.

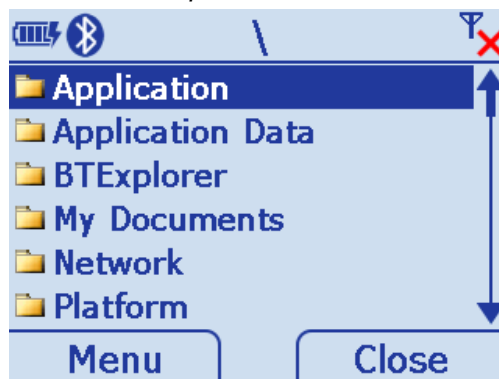

Figure 2-140 File Explorer Screen

### File Explorer Functionality

*File Explorer* allows the user to perform basic file system operations. Within the application use the *Menu* to:

- Search for files
- Rename files
- Delete files
- Create folders
- Launch programs with an .exe extension.

✓ **NOTE** Files with .bat, .lnk, and .cab extensions are not supported. To launch these file types, use \Windows\lnkwiz.exe.

### File Explorer Keypad Usage

- Enter key: Drills down one level when a folder is selected; attempts to execute an .exe file.
- Up/Down keys: Scrolls up and/or down in a list.
- Right/Left keys: Pages up and/or down.

### Task Manager

Scroll to *Task Manager* on the *Utilities* screen and press *ENT* to display the *Task Manager* screen.

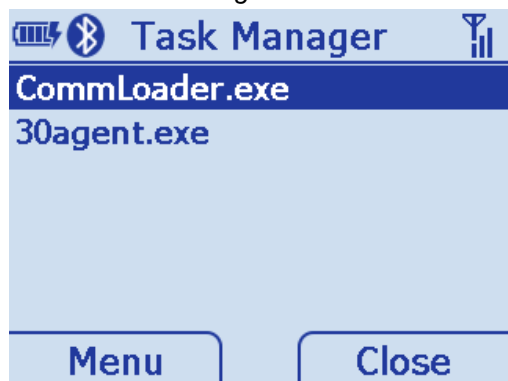

**Figure 2-141** *Task Manager* Screen

The *Task Manager* allows users to perform simple program management operations such as:

- Viewing/running programs/tasks
- Terminating running programs/tasks
- Switching to running programs/tasks.

---

## Resetting the MT20X0

If the device stops responding to input, reset it. There are two types of resets, warm boot and cold boot. A warm boot restarts the device by closing all running programs. All data that is not saved is lost.

A cold boot also restarts the device, but erases all stored records and entries from RAM. In addition it returns formats, preferences and other settings to the factory default settings.

Perform a warm boot first. This restarts the device and saves all stored records and entries. If the device still does not respond, perform a cold boot.

### Performing a Warm Boot

To perform a warm boot press and hold the 2 key and the scan trigger simultaneously for 5 seconds.

During a warm boot the following three items display as text on the screen:

- IPL
- OS
- PM.



**CAUTION** Files that remain open during a warm boot may not be retained.

### Performing a Cold Boot

A cold boot restarts the device and erases all user stored records and entries from RAM. Never perform a cold boot unless a warm boot does not solve the problem.



**CAUTION** A cold boot resets the device to the default settings and removes all added applications, user preferences and all stored data. Do not cold boot without support desk approval.

To perform a cold boot press and hold the 2 key and the scan trigger simultaneously for 10 seconds. During a cold boot the following two items display as text on the screen:

- IPL
- OS.

## Waking the MT20X0

The wakeup conditions define what actions wake up the device. These settings are configurable and the factory default settings shown in [Table 2-30](#) are subject to change/update.

**Table 2-30** *Wakeup Conditions (Default Settings)*

Status	Description	Conditions for Wakeup
Suspend	When the device is set to the suspend mode these actions wake the device.	AC power is added or removed. Cradle/cable connect or disconnect.
		Key or scan trigger press.
		Real Time Clock set to wake up.
Auto Off	When the automatic power-off function places the device in suspend mode these actions wake the device.	AC power added or removed. Cradle/cable connect or disconnect.
		Key or scan trigger press.
		Real Time Clock set to wake up.

## File System Directory Structure

The device directory structure displays all of the file folders. The pre-installed folders are in flash file system memory.

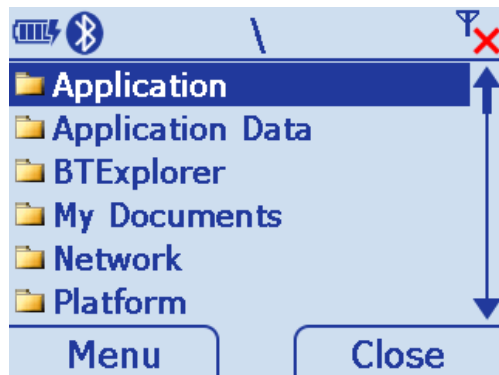

**Figure 2-142** *Directory Structure*

- Application and Platform folders are located in flash file system memory.
- The Windows, Program Files, profiles and My Documents folders are composite, RAM-based folders generated from ROM (many of these files are marked read only).
- The Network folder is a link to file systems mapped using the network redirector. The files do not physically reside on the device.
- The Temp and Recycled folders typically contain RAM based files.

✓ **NOTE** All files copied to the RAM-based folders are lost after a cold boot.





# Chapter 3 Scanning

---

## Introduction

This chapter provides beeper and LED definitions, techniques involved in scanning bar codes, general instructions and tips about scanning, and decode zone diagrams.

---

## Beeper Definitions

The device issues different beep sequences and patterns to indicate status. [Table 3-1](#) defines beep sequences that occur during both normal scanning and while programming the device.

**Table 3-1** *Beeper Definitions*

Beeper Sequence	Indication
<b>Standard Use</b>	
Low/medium/high beeps	Power up.
Short high beep	A bar code symbol was decoded (if decode beeper is enabled).
4 long low beeps	Transmission error.
5 low beeps	Conversion or format error.
Low/low/low/extra low beeps	RS-232 receive error.
High beep	The device detected a <BEL> character over RS-232.
<b>Image Capture</b>	
Low beep	Snapshot mode started or completed.
High/low beeps	Snapshot mode timed out.
<b>Parameter Menu Scanning</b>	
Low/high beeps	Input error; incorrect bar code, programming sequence, or <b>Cancel</b> scanned.
High/low beeps	Keyboard parameter selected. Enter value using numeric bar codes.

**Table 3-1** *Beeper Definitions (Continued)*

<b>Beeper Sequence</b>	<b>Indication</b>
High/low/high/low beeps	Successful program exit with change in parameter setting.
<b>Macro PDF (MPDF)</b>	
2 long low beeps	File ID error. A bar code not in the current MPDF sequence was scanned.
4 long low beeps	Bad symbology. Scanned a 1D or 2D bar code in a MPDF sequence, a duplicate MPDF label, a label in an incorrect order, or trying to transmit an empty or illegal MPDF field.
<b>Host Specific</b>	
<b>USB only</b>	
4 short high beeps	The device has not completed initialization. Wait several seconds and scan again.
Low/medium/high beeps upon scanning a USB device type	Communication with the bus must be established before the device can operate at the highest power level.
Low/medium/high beeps occur more than once.	The USB bus can put the device in a state where power to the device is cycled on and off more than once. This is normal and usually happens when the PC cold boots.
<b>RS-232 only</b>	
1 short high beep	A <BEL> character is received and Beep on <BEL> is enabled.

## LED Definitions

In addition to beep sequences, the device uses a two-color LED to indicate status. [Table 3-2](#) defines LED colors that display during scanning.

**Table 3-2** *Standard LED Definitions*

LED	Indication
<b>Hand-Held Scanning Standard Use</b>	
Off	No power is applied to the device, or the device is on and ready to scan.
Green	A bar code was successfully decoded.
Red	Transmission error, conversion or format error, device malfunction or RS-232 receive error.
<b>Hands-Free (Presentation) Scanning Standard Use</b>	
Off	No power is applied to the device.
Momentarily Off	A bar code was successfully decoded.
Green	The device is on and ready to scan.
Red	Transmission error, conversion or format error, or RS-232 receive error.
<b>Parameter Programming</b>	
Green	Number expected. Enter value using numeric bar codes. Successful program exit with change in parameter setting.
Red	Input error: incorrect bar code, programming sequence, or Cancel scanned.
<b>ADF Programming</b>	
Green	Enter another digit. Add leading zeros to the front if necessary. Enter another alphabetic character or scan the <b>End of Message</b> bar code. All criteria or actions cleared for current rule, continue entering rule. Delete last saved rule. The current rule is left intact. All rules deleted.
Blinking Green	Enter another criterion or action, or scan the <b>Save Rule</b> bar code.
Green after Blinking	Rule saved. Rule entry mode exited. Cancel rule entry. Rule entry mode exited because of an error or the user asked to exit rule entry.
Red	Out of rule memory. Erase some existing rules, then try to save rule again. Entry error, wrong bar code scanned, or criteria/action list is too long for a rule. Re-enter criterion or action.

## Scanning in Hand-Held Mode



**IMPORTANT** A scan application, such as *Scan Item* (scanitem.exe), must be launched to allow scanning. See [Scan Item on page 2-17](#) for more information.

### Scanning with the MT20X0

When out of the IntelliStand or removed from the wall mount bracket, the device operates in standard trigger mode. Aim the device at a bar code and pull the trigger to decode.

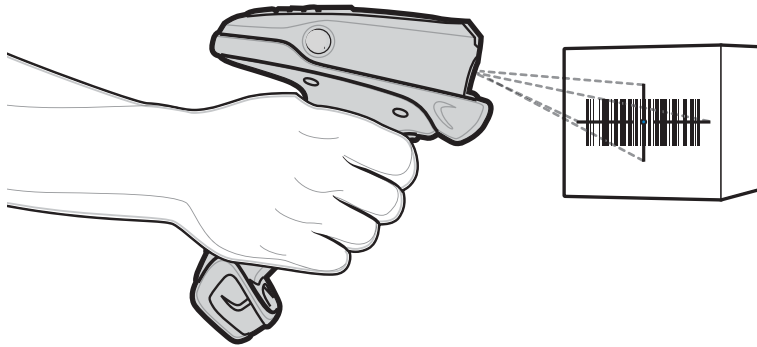

**Figure 3-1** Scanning in Hand-Held Mode

Hold the trigger until the device beeps, indicating the bar code is successfully decoded. For more information on beeper and LED definitions, see [Table 3-1](#) and [Table 3-2](#).

## Aiming

### Imager Aiming

When scanning, the device projects a red laser aiming pattern which allows positioning the bar code within its field of view. See [Decode Distances on page 3-9](#) for the proper distance to achieve between the device and a bar code.

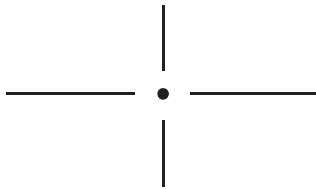

**Figure 3-2** Imager Aiming Pattern

If necessary, the device turns on its red LEDs to illuminate the target bar code.

To scan a bar code, center the symbol in any orientation within the aiming pattern. Be sure the entire symbol is within the rectangular area formed by the cross pattern.

1D bar code symbol

2D bar code symbol

2D dot peen DPM symbol

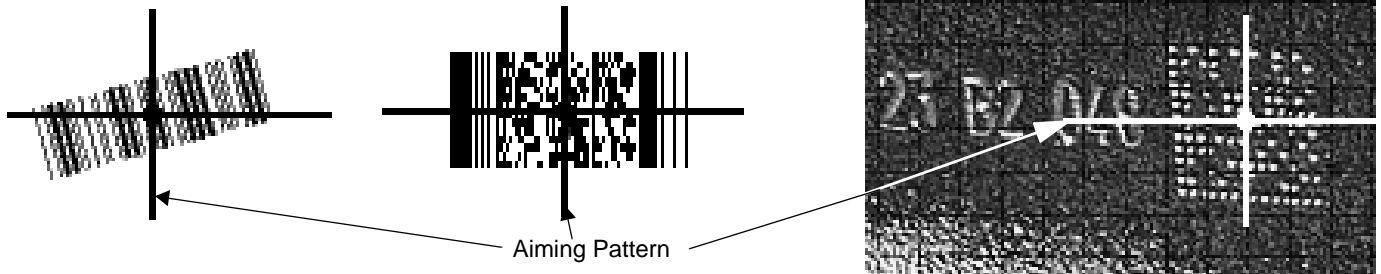
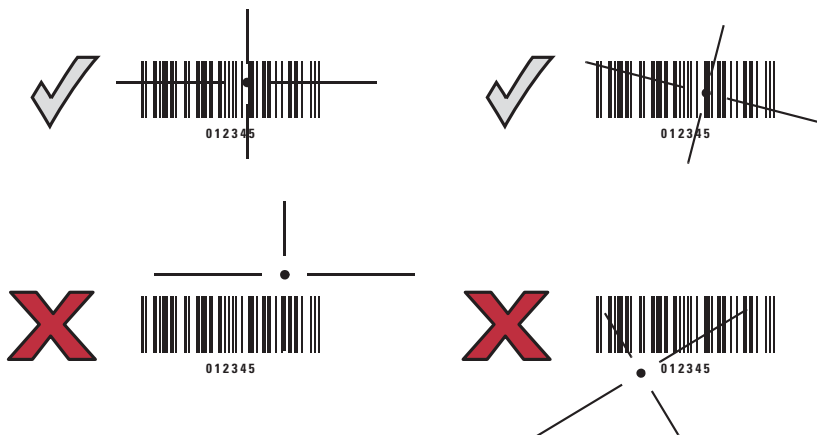

**Figure 3-3** Scanning Orientation with Imager Aiming Pattern

- ✓ **NOTE** Scanning Direct Part Mark (DPM) bar codes with the MT2070-DP scanner: Due to the reflective nature of some surfaces used with DPM bar codes (see [Figure 3-3](#)), it may be necessary to tilt the scanner at an angle relative to the target (Zebra recommends 25-45 degrees). For example, when scanning a 15 mil dot peen Data Matrix bar code marked on an aluminum surface, present the target between two and three inches from the nose of the scanner, and tilt the scanner at a 30 degree angle.

When scanning standard (non-DPM) bar codes with any configuration of the scanner, follow the standard aiming instructions described in [Aiming on page 3-4](#).

The device can also read a bar code presented within the aiming pattern but not centered. The top examples in [Figure 3-4](#) show acceptable aiming options, while the bottom examples can not be decoded.



**Figure 3-4** Acceptable and Incorrect Aiming

## Laser Aiming

In hand-held mode, the laser device projects a laser line by default. Ensure the scan line crosses every bar and space of the symbol.

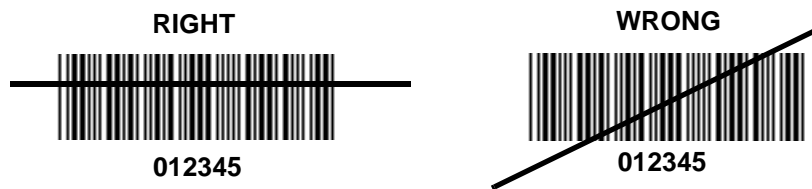

**Figure 3-5** *Scanning Orientation with Laser Aiming Pattern*

The aiming pattern (or laser line) is smaller when the device is closer to the symbol and larger when it is farther from the symbol. Scan symbols with smaller bars or elements (mil size) closer to the device, and those with larger bars or elements (mil size) farther from the device.

The device beeps to indicate that it successfully decoded the bar code. For more information on beeper and LED definitions, see [Table 3-1](#) and [Table 3-2](#).

## Scanning in Presentation Mode

The optional IntelliStand adds greater flexibility to scanning operation. When you insert the device into the stand's "cup," the device's built-in sensor places the device in presentation (hands-free) mode. When you remove the device from the stand it operates in its normal hand-held mode.

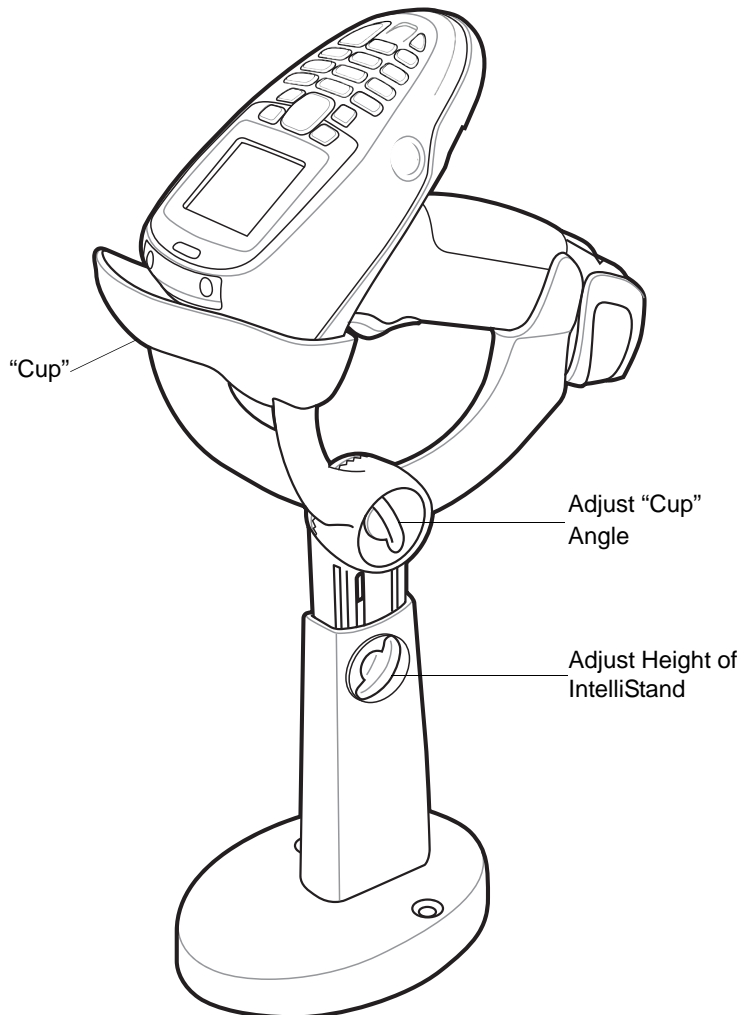

**Figure 3-6** *Inserting the Device in the IntelliStand*

To operate the device in the IntelliStand:

1. Connect the device to the host (see the appropriate host chapter for information on host connections).
2. Insert the device in the IntelliStand by placing the front of the device into the stand's "cup" (see [Figure 3-6](#)).
3. Use the IntelliStand's adjustment knobs to adjust the height and angle of the device.
4. Center the symbol in the aiming pattern. The entire symbol must be within the brackets.
5. Upon successful decode, the device beeps and the LED turns green. For more information on beeper and LED definitions, see [Table 3-1](#) and [Table 3-2](#).

## Scanning Considerations

Scanning is a simple matter of aim, scan and decode. However, to optimize scanning performance consider the range and the scanning angle:

- Range

Any scanning device decodes well over a particular working range — minimum and maximum distances from the bar code. This range varies according to bar code density and scanning device optics.

Scanning within range brings quick and constant decodes; scanning too close or too far away prevents decodes. Move the device closer and further away to find the right working range for the bar codes being scanned. However, the situation is complicated by the availability of various integrated scanning modules. The best way to specify the appropriate working range per bar code density is through a chart called a decode zone for each scan module. A decode zone simply plots working range as a function of minimum element widths of bar code symbols.

- Angle

Scanning angle is important for promoting quick decodes. When laser beams reflect directly back into the device from the bar code, this specular reflection can “blind” the device.

To avoid this, scan the bar code so that the beam does not bounce directly back. But don't scan at too sharp an angle; the device needs to collect scattered reflections from the scan to make a successful decode. Practice quickly shows what tolerances to work within.



**NOTE** Contact Zebra Support if persistent scanning difficulties develop. Decoding properly printed bar codes should be quick and effortless.



**NOTE** It is recommended that power is applied to the device while in Intellistand.



## Decode Distances

**Table 3-3** MT2070/2090-SL (Standard Range Laser) Decode Distances

Label Density	Typical Working Range	
	English	Metric
Code 39 - 4 mil	0.1 - 2.8 in.	0.254 - 7.112 cm
Code 39 - 5 mil	0.2 - 5.3 in.	0.508 - 13.462 cm
Code 39 - 7.5 mil	0.5 - 10.4 in	1.27 - 26.416 cm
UPC 100% - 13 mil	0.2 - 21.9 in.	0.508 - 55.626 cm
Code 39 - 20 mil	** - 29.1 in.	** - 73.914 cm
Code 39 - 40 mil	** - 42.1 in.	** - 106.934 cm
Code 39 - 55 mil	** - 51.2 in.	** - 130.048 cm

**\*\* Near decode distance is limited by the field of view  
Decode distances are measured under ambient light of 35  
(±5) foot-candle in the plane of the farthest bar code.**

**Table 3-4** MT2070/2090-ML (Medium Range Laser) Decode Distances

Label Density	Typical Working Range	
	English	Metric
Code 39 - 5 mil	0.1 - 11.8 in.	0.254 - 29.97 cm
Code 39 - 7.5 mil	0.1 - 18.2 in.	.254 - 46.23 cm
UPC 100% - 13 mil	0.2 - 26.3 in.	0.508 - 66.80 cm
Code 39 - 20 mil	0.2 - 46.1 in.	.508 - 117.09 cm
Code 39 - 40 mil	** - 95.0 in.	** - 241.30 cm
Code 39 - 55 mil	** - 100 in.	** - 254 cm
Code 39 - 100 mil	** - 192 in.	** - 487.68 cm

**\*\* Near decode distance is limited by the field of view  
Decode distances are measured under ambient light of 35  
(±5) foot-candle in the plane of the farthest bar code.**

**Table 3-5** MT2070/2090-SD (Standard Range Imager) Decode Distances

Label Density	Typical Working Range	
	English	Metric
Code 39 - 5 mil	1.2 - 6.3 in.	3.048 - 16.002 cm
Code 39 - 7.5 mil	0.2 - 10.6 in.	0.508 - 26.924 cm
UPC 100% - 13 mil	** - 15.4 in.	** - 39.116 cm
Code 39 - 20 mil	** - 23.2 in.	** - 58.928 cm
PDF - 6.67 mil	2.5 - 6.1 in.	6.35 - 15.494 cm
PDF - 10 mil	0.7 - 9.6 in.	1.778 - 24.384 cm
PDF - 15 mil	** - 14.2 in.	** - 36.068 cm

**\*\* Near decode distance is limited by the field of view  
Decode distances are measured under ambient light of 35  
(±5) foot-candle in the plane of the farthest bar code.**

**Table 3-6** MT2070/2090-HD (High Density Range Imager) Decode Distances

Label Density	Typical Working Range	
	English	Metric
Code 39 - 3 mil	0.5 - 2.9 in.	1.27 - 7.366 cm
Code 39 - 5 mil	0 - 4.1 in.	0 - 10.414 cm
Code 39 - 7.5 mil	0.1 - 5.5 in.	0.254 - 13.97 cm
UPC 100% - 13 mil	0.6 - 6.1 in.	1.524 - 15.494 cm
Code 39 - 20 mil	** - 10.3 in.	** - 26.162 cm
PDF - 4 mil	0.8 - 2.6 in.	2.032 - 6.604 cm
PDF - 5 mil	0.5 - 3.0 in.	1.27 - 7.62 cm
PDF - 6.67 mil	0.2 - 3.6 in.	0.508 - 9.144 cm
PDF - 10 mil	0.4 - 4.5 in.	1.016 - 11.43 cm
PDF - 15mil	** - 5.9 in.	** - 14.986 cm

**\*\* Near decode distance is limited by the field of view  
Decode distances are measured under ambient light of 35  
(±5) foot-candle in the plane of the farthest bar code.**

# Chapter 4 Radio Communications

---

## Introduction

This chapter provides information about the modes of operation and features available for wireless communication between MT20X0s, cradles and hosts. The chapter also includes the parameters necessary to configure the device.

The device ships with the settings shown in the [Table 4-1 on page 4-2](#) (also see [Appendix A, Standard Default Parameters](#) for all host device and miscellaneous device defaults). If the default values suit requirements, programming is not necessary.

To set feature values, scan a single bar code or a short bar code sequence. The settings are stored in non-volatile memory and are preserved even when the device is powered down.

If not using a USB cable with the cradle, select a host type (see each host chapter for specific host information) after the power-up beeps sound. This is only necessary upon the first power-up when connected to a new host.

To return all features to default values, scan a bar code in [Set Default Parameter on page 5-4](#). Throughout the programming bar code menus, default values are indicated with asterisks (\*).



\* Indicates Default

**\*Disable Pair on Contacts**

Feature/Option

## Scanning Sequence Examples

In most cases, scan one bar code to set a specific parameter value.

## Errors While Scanning

Unless otherwise specified, to correct an error during a scanning sequence, just re-scan the correct parameter.

## Radio Communications Parameter Defaults

[Table 4-1](#) lists the defaults for radio communication parameters. If you wish to change any option, scan the appropriate bar code(s) provided in this chapter.

✓ **NOTE** See [Appendix A, Standard Default Parameters](#) for all user preferences, hosts, symbologies, and miscellaneous default parameters.

**Table 4-1** Radio Communication Default Table

Parameter	Default	Page Number
Bluetooth Host (Host Type)	Cradle Host	4-5
Bluetooth Friendly Name	Device name and serial number	4-7
Discoverable Mode	General	4-7
Country Keyboard Types (Country Code)	North American	4-8
HID Keyboard Keystroke Delay	No Delay (0 msec)	4-10
CAPS Lock Override	Disable	4-10
Ignore Unknown Characters	Enable	4-11
Emulate Keypad	Disable	4-11
Keyboard FN1 Substitution	Disable	4-12
Function Key Mapping	Disable	4-12
Simulated Caps Lock	Disable	4-13
Convert Case	No Case Conversion	4-13
Beep on Reconnect Attempt	Disable	4-14
Reconnect Attempt Interval	30 sec	4-15
Auto-reconnect in Bluetooth Keyboard Emulation (HID Slave) Mode	On Bar Code Data	4-17
Modes of Operation (Point-to-Point/Multipoint-to-Point)	Point-to-Point	4-19
Parameter Broadcast (Cradle Host Only)	Enable	4-20
Pairing Modes	Unlocked	4-21
Pairing on Contacts	Disable	4-22
Connection Maintenance Interval	15 min	4-23
Authentication	Disable	4-26
Variable Pin Code	Static	4-27
Encryption	Disable	4-28

## Wireless Beeper Definitions

When the device scans the pairing bar code it issues various beep sequences indicating successful or unsuccessful operations. See [Table 4-2](#) for beep sequences that occur during pairing operations.

**Table 4-2** *Wireless Beeper Definitions*

Beeper Sequence	Indication
Short low-high beeps	Device has paired with the cradle.
Short high-low beeps	Device has unpaired with the cradle. Note: When connected to a remote device using SPP or HID, if a disconnect beep sequence sounds immediately after scanning a bar code, check the host device to determine if it received the transmitted data. The device may have transmitted the last bar code scanned after losing the connection.
Long low-long high beeps	Unsuccessful pairing attempt. See <a href="#">Auto-reconnect Feature on page 4-14</a> .
Long low-long high-long low-long high beeps	Remote device rejected connection attempt, possibly due to an attempt to pair with a cradle that is already paired with the maximum number of devices.
Four long low beeps	<ol style="list-style-type: none"> <li>1. A transmission error was detected in a scanned symbol. The data is ignored. This occurs if a unit is not properly configured. Check option setting.</li> <li>2. When communicating with a cradle, the cradle acknowledges receipt of data. If the acknowledgment is not received, this transmission error beep sequence sounds. Data may still have been received by the host. Check the host system for receipt of transmitted data. If data was not received by the host, re-scan the bar code.</li> </ol>
Five high beeps	Emitted every 5 seconds while a reconnect attempt is in progress. See <a href="#">Auto-reconnect Feature on page 4-14</a> .

---

## Radio Communications Host Types

To set up the device for communication with a cradle, or to use standard Bluetooth profiles, scan the appropriate host type bar code below.

- Cradle Host (default) - Select this host type for device(s) to cradle operation. The device must then be paired to the cradle and the cradle communicates directly to the host via the host interface cable connection.
- Serial Port Profile (Master) - Select this host type for Bluetooth Technology Profile Support (see [page 4-6](#)). The device connects to the PC/host via Bluetooth and behaves like there's a serial connection. The device initiates the connection to the remote device and is the Master. Scan **Serial Port Profile (Master)**, then scan the **PAIR** bar code for the remote device. See [Pairing Bar Code Format on page 4-23](#) for information about creating a pairing bar code for a remote device.
- Serial Port Profile (Slave) - Select this host type for Bluetooth Technology Profile Support (see [page 4-6](#)). The device connects to the PC/host via Bluetooth and behaves like there's a serial connection. The device accepts incoming connection requested from a remote device and is the Slave. Scan **Serial Port Profile (Slave)** and wait for the incoming connection.
- Bluetooth Keyboard Emulation (HID Slave) - Select this host type for Bluetooth Technology Profile Support. (See [page 4-6](#) for Bluetooth Technology Profile Support and Master/Slave definitions.) The device connects to the PC/host via Bluetooth and behaves like a keyboard. The device accepts incoming connection requested from a remote device and is the slave. Scan **Bluetooth Keyboard Emulation (HID Slave)** and wait for the incoming connection.



**NOTE** 1. The device supports keyboard emulation over the Bluetooth HID profile. For detailed information, and HID host parameters, see [HID Host Parameters on page 4-8](#).

2. When the device is paired to the cradle in SPP Master or Cradle Host mode, the device automatically tries to reconnect to a remote device when a disconnection occurs that is due to the radio losing communication. For more information see [Auto-reconnect Feature on page 4-14](#).

---

## Radio Communications Host Types (continued)



**\*Cradle Host**



**Serial Port Profile (Master)**



**Serial Port Profile (Slave)**



**Bluetooth Keyboard Emulation (HID Slave)**

---

## Bluetooth Technology Profile Support

With Bluetooth Technology Profile Support, the cradle is not required for wireless communication. The device communicates directly to the host using Bluetooth technology. The device supports the standard Bluetooth Serial Port Profile (SPP) and HID Profiles which enable the device to communicate with other Bluetooth devices that support these profiles.

- SPP - the device connects to the PC/host via Bluetooth and performs like there's a serial connection.
- HID - the device connects to the PC/host via Bluetooth and performs like a keyboard.

### Master/Slave Set Up

The device can be set up as a Master or Slave.

When the device is set up as a Slave, it is discoverable and connectable to other devices. When the device is set up as a Master, the Bluetooth address of the remote device to which a connection is requested is required. A pairing bar code with the remote device address must be created and scanned to attempt a connection to the remote device. See the [Pairing Bar Code Format on page 4-23](#) for information about creating a pairing bar code.

#### Master

When the device is set up as a Master (SPP), it initiates the radio connection to a slave device. Initiating the connection is done by scanning a pairing bar code for the remote device (see [Pairing Bar Code Format on page 4-23](#)).

#### Slave

When the device is set up as a Slave device (SPP or HID), the device accepts an incoming connection request from a remote device.



**NOTE** The number of devices is dependent on the host's capability.



## Bluetooth Friendly Name

You can set a meaningful name for the device that appears in the application during device discovery. The default name is the device name followed by its serial number, e.g., **MT2070/MT2090 123456789ABCDEF**. Scanning **Set Defaults** reverts the device to this name; use custom defaults to maintain the user-programmed name through a **Set Defaults** operation.

To set a new Bluetooth Friendly Name, scan the following bar code, then scan up to 23 characters from [Appendix E, Alphanumeric Bar Codes](#). If the name contains less than 23 characters, scan [End of Message on page E-7](#) after entering the name.



**NOTE** If your application allows you to set a device name, this takes precedence over the Bluetooth Friendly Name.



**Bluetooth Friendly Name**

## Discoverable Mode

Select a discoverable mode based on the device initiating discovery:

- Select **General Discoverable Mode** when initiating connection from a PC.
- Select **Limited Discoverable Mode** when initiating connection from a mobile device (e.g., Zebra Q), and the device does not appear in General Discoverable Mode. Note that it can take longer to discover the device in this mode.

The device remains in Limited Discoverable Mode for 30 seconds, and green LEDs flash while in this mode. It is then non-discoverable. To re-activate Limited Discoverable Mode, press the trigger.



**\*General Discoverable Mode**



**Limited Discoverable Mode**

---

## HID Host Parameters

The device supports keyboard emulation over the Bluetooth HID profile. In this mode the device can interact with Bluetooth enabled hosts supporting the HID profile as a Bluetooth keyboard. Scanned data is transmitted to the host as keystrokes.

Following are the keyboard parameters supported by the HID host.

### HID Country Keyboard Types (Country Codes)

Scan the bar code corresponding to the keyboard type.



**\*North American Standard Keyboards**



**French Windows**



**German Windows**



**French Canadian Windows 98**



**Spanish Windows**

### HID Country Keyboard Types (Country Codes - continued)



**Italian Windows**



**Swedish Windows**



**UK English Windows**



**Japanese Windows**



**French Canadian Windows 2000/XP**



**Portuguese/Brazilian Windows**

## HID Keyboard Keystroke Delay

This parameter sets the delay, in milliseconds, between emulated keystrokes. Scan a bar code below to increase the delay when the HID host requires a slower transmission of data.



**\*No Delay (0 msec)**



**Medium Delay (20 msec)**



**Long Delay (40 msec)**

## HID CAPS Lock Override

When enabled, the case of the data is preserved regardless of the state of the caps lock key. This setting is always enabled for the “Japanese, Windows (ASCII)” keyboard type and can not be disabled.



**\*Do Not Override Caps Lock Key  
(Disable)**



**Override Caps Lock Key  
(Enable)**

## HID Ignore Unknown Characters

Unknown characters are characters the host does not recognize. When **Send Bar Codes With Unknown Characters** is scanned, all bar code data is sent except for unknown characters, and no error beeps sound. When **Do Not Send Bar Codes With Unknown Characters** is scanned, bar codes containing at least one unknown character are not sent to the host, and an error beep sounds.



**\*Send Bar Codes With Unknown Characters  
(Enable)**



**Do Not Send Bar Codes With Unknown Characters  
(Disable)**

## Emulate Keypad

When enabled, all characters are sent as ASCII sequences over the numeric keypad. For example, ASCII A is sent as "ALT make" 0 6 5 "ALT Break."



**\*Disable Keypad Emulation**



**Enable Keypad Emulation**

## HID Keyboard FN1 Substitution

When enabled, this parameter allows replacement of any FN1 character in an EAN128 bar code with a Key Category and value chosen by the user. See [FN1 Substitution Values on page 5-26](#) to set the Key Category and Key Value.



**\*Disable Keyboard FN1 Substitution**



**Enable Keyboard FN1 Substitution**

## HID Function Key Mapping

ASCII values under 32 are normally sent as control-key sequences. When this parameter is enabled, the keys in bold are sent in place of the standard key mapping (see [Table 9-3 on page 9-25](#)). Table entries that do not have a bold entry remain the same whether or not this parameter is enabled.



**\*Disable Function Key Mapping**



**Enable Function Key Mapping**

## Simulated Caps Lock

When enabled, the device inverts upper and lower case characters on the device bar code as if the Caps Lock state is enabled on the keyboard. This inversion is done regardless of the current state of the keyboard Caps Lock state.



**\*Disable Simulated Caps Lock**



**Enable Simulated Caps Lock**

## Convert Case

When enabled, the device converts all bar code data to the selected case.



**\*No Case Conversion**



**Convert All to Upper Case**



**Convert All to LowerCase**

## Auto-reconnect Feature

When in SPP Master or Cradle Host mode, the device automatically tries to reconnect to a remote device when a disconnection occurs that is due to the radio losing communication. This can happen if the device goes out of range with the remote device, or if the remote device powers down. The device tries to reconnect for the period of time specified by the Reconnect Attempt Interval setting. During that time the green LED continues to blink.

If the auto-reconnect process fails due to page timeouts, the device sounds a page timeout beep (long low/long high) and enters low power mode. The auto-reconnect process can be re-started by pulling the device trigger.

If the auto-reconnect process fails because the remote device rejects the connection attempt, the device sounds a connection reject beep sequence (see [Wireless Beeper Definitions on page 4-3](#)) and deletes the remote pairing address. If this happens, a pairing bar code must be scanned to attempt a new connection to the remote device.

- ✓ **NOTE** If a bar code is scanned while the auto-reconnect sequence is in process, a transmission error beep sequence sounds and the data is not transmitted to the host. After a connection is reestablished, normal scanning operation returns. For error beep sequence definitions, see [Beeper Definitions on page 3-1](#).

The device has memory available for storing a remote Bluetooth address for each Master mode (SPP, Cradle). When switching between these modes, the device automatically tries to reconnect to the last device it was connected to in that mode.

- ✓ **NOTE** Switching between Bluetooth host types by scanning a host type bar code ([page 4-4](#)) causes the radio to be reset. Scanning is disabled during this time. It takes several seconds for the device to re-initialize the radio at which time scanning is enabled.

## Reconnect Attempt Beep Feedback

When a device disconnects as it goes out of range, it immediately attempts to reconnect. While the device attempts to reconnect, the green LED continues to blink. If the auto-reconnect process fails, the device emits a page timeout beep (long low/long high) and stops blinking the LED. The process can be restarted by pulling the trigger.

The Beep on Reconnect Attempt feature is disabled by default. When enabled, the device emits 5 short high beeps every 5 seconds while the reconnect attempt is in progress.

Scan a bar code below to enable or disable Beep on Reconnect Attempt.



**\*Disable Beep on Reconnect Attempt**



**Enable Beep on Reconnect Attempt**



## Reconnect Attempt Interval

When a device disconnects as it goes out of range, it immediately attempts to reconnect for the default time interval of 30 seconds. This time interval can be changed to one of the following options:

- 30 seconds
- 1 minute
- 5 minutes
- 30 minutes
- 1 hour
- Indefinitely.

To set the Reconnect Attempt Interval, scan one of the bar codes below



**\*Attempt to Reconnect for 30 Seconds**



**Attempt to Reconnect for 1 Minute**



**Attempt to Reconnect for 5 Minutes**



**Attempt to Reconnect for 30 Minutes**

### Reconnect Attempt Interval (continued)



**Attempt to Reconnect for 1 Hour**



**Attempt to Reconnect Indefinitely**

## Auto-reconnect in Bluetooth Keyboard Emulation (HID Slave) Mode

In Bluetooth Keyboard Emulation (HID Slave) mode, select a re-connect option for when the device loses its connection with a remote device:

- **Auto-reconnect on Bar Code Data:** The device auto-reconnects when you scan a bar code. With this option, a delay can occur when transmitting the first characters. The device sounds a decode beep upon bar code scan, followed by a connection, a page timeout, a rejection beep, or a transmission error beep. Select this option to optimize battery life on the device and mobile device. Note that auto-reconnect does not occur on rejection and cable unplug commands.
- **Auto-reconnect Immediately:** When the device loses connection, it attempts to reconnect. If a page timeout occurs, the device attempts reconnect on a trigger pull. Select this option if the device's battery life is not an issue and you do not want a delay to occur when the first bar code is transmitted. Note that auto-reconnect does not occur on rejection and cable unplug commands.
- **Disable Auto-reconnect in Bluetooth Keyboard Emulation (HID Slave) Mode:** When the device loses connection, you must re-establish it manually.

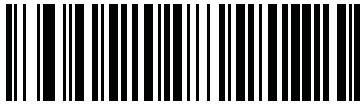

\*Auto-reconnect on Bar Code Data



Auto-reconnect Immediately



Disable Auto-reconnect in  
Bluetooth Keyboard Emulation (HID Slave) Mode

## Out of Range Indicator

An out of range indicator can be set by scanning [Enable Beep on Reconnect Attempt on page 4-14](#) and extending the time using the [Reconnect Attempt Interval on page 4-15](#).

For example, with Beep on Reconnect Attempt disabled while the device loses radio connection when it is taken out of range, the device attempts to reconnect silently during the time interval set by scanning a Reconnect Attempt Interval.

When Beep on Reconnect Attempt is enabled, the device emits 5 high beeps every 5 seconds while the reconnect attempt is in progress. If the Reconnect Attempt Interval is adjusted to a longer period of time, such as 30 minutes, the device emits 5 high beeps every 5 seconds for 30 minutes providing an out of range indicator.

---

## MT20X0(s) To Cradle Support

### Modes of Operation

The charging cradle with radio supports two radio communication modes of operation, allowing the device to communicate wirelessly:

- Point-to-Point
- Multipoint-to-Point.

#### Point-to-Point Communication

In Point-to-Point communication mode, the cradle allows one device to connect to it at a time. In this mode, the device is paired to the cradle either by insertion into the cradle (if pairing on contacts is enabled, [page 4-22](#)), or by scanning the **PAIR** bar code on the cradle. Communication can be locked, unlocked (default), or in a lock override state (see [Pairing Modes on page 4-21](#)). In locked mode, locking intervals must be set by scanning a connection maintenance interval bar code beginning on [page 4-23](#).

To activate this mode of operation, scan **Point-to-Point**.

#### Multipoint-to-Point Communication

In Multipoint-to-Point communication mode, up to seven devices can be paired to one cradle.

To activate this mode, the first device connected to the cradle must scan the **Multipoint-to-Point** bar code. This mode allows a parameter broadcast ([page 4-20](#)) that clones all devices paired to the cradle so only one device needs to be programmed.

To select Point-to-Point or Multipoint-to-Point mode, scan the appropriate bar code.



**Multipoint-to-Point Mode**



**\*Point-to-Point Mode**

## Parameter Broadcast (Cradle Host Only)

In both multipoint-to-point mode and single point mode, enable Parameter Broadcast to store parameter updates from the cradle. Disable Parameter Broadcast to ignore parameter configurations that come up from the cradle. In multipoint-to-point mode, the cradle forwards parameter settings to all connected scanners, each scanner decides to store the parameter or not based on the parameter broadcast setting.



\*Enable Parameter Broadcast



Disable Parameter Broadcast

## Pairing

Pairing is the process by which a device initiates communication with a cradle. Scanning **Multipoint-to-Point** activates multi device-to-cradle operation and allows up to seven devices to pair to one cradle. The cradle includes a pairing bar code.

To pair the device with the cradle, scan the pairing bar code on the cradle. A high/low/high/low beep sequence indicates that the pairing bar code was decoded. When a connection between the cradle and device is established, a low/high beep sounds.



- NOTE**
1. The pairing bar code that connects the device to a cradle is unique to each cradle.
  2. Do not scan data or parameters until pairing completes.
  3. When the device is paired to the cradle in SPP Master or Cradle Host mode, the device automatically tries to reconnect to a remote device when a disconnection occurs that is due to the radio losing communication. For more information see [Auto-reconnect Feature on page 4-14](#).

## Pairing Modes

When operating with the cradle, two modes of pairing are supported:

- **Locked Pairing Mode** - When a cradle is paired (connected) to the device (or to seven devices in Multipoint-to-Point mode), any attempt to connect a different device, by either scanning the **PAIR** bar code on the cradle or by inserting it into the cradle with the pairing on contacts feature enabled ([page 4-22](#)), is rejected. The currently connected device(s) maintain connection. In this mode, you must set a [Connection Maintenance Interval on page 4-23](#).

In Locked Pairing Mode/Multipoint-to-Point mode, lock override is required for an eighth device to connect.

- **Unlocked Pairing Mode** - Pair (connect) a new device to a cradle at any time by either scanning the **PAIR** bar code on the cradle or by inserting it into the cradle with the pairing on contacts feature enabled. This unpairs the previous device from the cradle.

In Unlocked Pairing Mode/Multipoint-to-Point mode, an eighth device connection succeeds by disconnecting a device that is already connected.

To set the cradle pairing mode, scan the appropriate bar code below.



**\*Unlocked Pairing Mode**



**Locked Pairing Mode**

## Lock Override

**Lock Override** overrides a locked device base pairing and connects a new device. In Multipoint-to-Point mode, this unpairs any disconnected (out of range) device first, in order to connect the new device.

To use **Lock Override**, scan the bar code below, followed by the pairing bar code on the cradle.



**LockOverride**

## Pairing Methods

There are two pairing methods. The default method allows the device and cradle to pair (connect) when the pairing bar code on the cradle is scanned. A second method pairs the device and cradle when the device is inserted in the cradle. To enable this feature, scan **Enable Pair On Contacts** below. With this feature enabled it is not necessary to scan the pairing bar code on the cradle. If the pairing is successful, a low/high connection beep sequence sounds a few seconds after the device is placed in the cradle. See [Wireless Beeper Definitions on page 4-3](#) for other beep sequences.

To enable or disable pairing on contacts, scan the appropriate bar code below.



**Enable Pair On Contacts**



**\*Disable Pair on Contacts**

## Unpairing

Unpair the device from the cradle or PC/host to make the cradle available for pairing with another device. Scan the bar code below to disconnect the device from its cradle/PC host.

An unpairing bar code is also included in the *MT2070/MT2090 Quick Start Guide*.



**Unpairing**



## Pairing Bar Code Format

When the device is configured as an SPP Master, you must create a pairing bar code for the remote Bluetooth device to which the device can connect. You must know the Bluetooth address of the remote device. Pairing bar codes are Code 128 bar codes and are formatted as follows:

<Fnc 3>Bxxxxxxxxxxx

where:

- **B** (or **LNKB**) is the prefix
- xxxxxxxxxxxx represents the 12-character Bluetooth address.

## Pairing Bar Code Example

If the remote device to which the device can connect has a Bluetooth address of 11:22:33:44:55:66, then the pairing bar code is:



## Connection Maintenance Interval

✓ **NOTE** The Connection Maintenance Interval only applies in locked pairing mode (see [page 4-21](#)).

When a device disconnects from a cradle due to a Link Supervision Timeout, the device immediately attempts to reconnect to the cradle for 30 seconds. If the auto-reconnect process fails, it can be restarted by pulling the device trigger.

To guarantee that a disconnected device can reconnect when it comes back in range, the cradle reserves the connection for that device for a period of time defined by the Connection Maintenance Interval. If the cradle is supporting the maximum three devices and one device disconnects, a fourth device cannot pair to the cradle during this interval. To connect another device, either wait until the connection maintenance interval expires then scan the **PAIR** bar code on the cradle with the new device; or scan **Lock Override** ([page 4-21](#)) with the new device then scan the **PAIR** bar code on the cradle.

✓ **NOTE** When the cradle supports the maximum three devices, it stores the remote pairing address of each device in memory regardless of the device condition (e.g., discharged battery). When you want to change the devices paired to the cradle, unpair each device currently connected to the cradle by scanning the [Unpairing](#) bar code prior and reconnect each appropriate device by scanning the PAIR bar code on the cradle.

Connection Maintenance Interval options are:

- 15 minutes
- 30 minutes
- One hour
- Two hours
- Four hours
- Eight hours
- 24 hours
- Indefinitely.

### Considerations

The system administrator determines the Connection Maintenance Interval. A shorter interval allows new users to gain access to abandoned connections more quickly, but causes problems if users leave the work area for extended periods. A longer interval allows existing users to leave the work area for longer periods of time, but ties up the system for new users.

To avoid this conflict, users who are going off-shift can scan the unpair bar code on [page 4-22](#) to ignore the Connection Maintenance Interval and make the connection immediately available.

To set the Connection Maintenance Interval, scan one of the bar codes below.



**\*Set Interval to 15 Minutes**



**Set Interval to 30 Minutes**



**Set Interval to 60 Minutes**



**Set Interval to 2 Hours**

### Connection Maintenance Interval (continued)



**Set Interval to 4 Hours**



**Set Interval to 8 Hours**



**Set Interval to 24 Hours**



**Set Interval to Forever**

---

## Bluetooth Security

The device supports Bluetooth Authentication and Encryption. Authentication can be requested by either the remote device or the device. When Authentication is requested, the device uses its programmed PIN code to generate a link key. The device stores this link key upon pairing, so you do not have to re-enter the PIN code when moving in and out of range, switching profiles, or switching between devices (e.g., between the cradle and the application).

Once Authentication is complete, either device may then negotiate to enable Encryption.

✓ **NOTE** A remote device can still request Authentication.

### Authentication

To force Authentication with a remote device (including the cradle), scan the **Enable Authentication** bar code below. To prevent the device from forcing Authentication, scan the **Disable Authentication** bar code below.



**Enable Authentication**



**\*Disable Authentication**

## PIN Code

To set the PIN code (e.g., password) on the device, scan the bar code below followed by five alphanumeric programming bar codes from [Appendix E, Alphanumeric Bar Codes](#). The default PIN code is **12345**.

If the device communicates with a cradle with security enabled, synchronize the PIN codes on the device and cradle. To achieve this, connect the device to the cradle when setting the PIN codes. If the device is not connected to a cradle, the PIN code change only takes effect on the device. If security is required between the device and cradle, and the PIN codes do not match, pairing fails. If the PIN codes are not synchronized, re-synchronize them by disabling security, establishing a connection to the cradle, and then programming a new PIN code.



**Set PIN Code**

## Variable PIN Code

The default PIN code is the user-programmed Static PIN Code. For connections requiring a variable PIN code (commonly HID) scan the **Variable PIN Code Mode**. Attempt connection again, wait for the prompt to appear on the display and enter the PIN code using the device keypad. When variable PIN code mode is selected the device remains in this mode until you change the mode by device set defaults (see [Set Default Parameter on page 5-4](#)) or **Static PIN Code Mode**.



**\*Static PIN Code Mode**



**Variable PIN Code Mode**

## Encryption



**NOTE** Authentication must be performed before Encryption can take effect.

To set up the device for enabling Encryption, scan **Enable Encryption**. To prevent the device from enabling Encryption, scan **Disable Encryption**. When enabled, the radio encrypts data.



**Enable Encryption**



**\* Disable Encryption**

# Chapter 5 User Preferences & Miscellaneous Scanner Options

## Introduction

You can program the device to perform various functions, or activate different features. This chapter describes each user preference feature and provides programming bar codes for selecting these features.

The device ships with the settings shown in [Table 5-1 on page 5-2](#) (also see [Appendix A, Standard Default Parameters](#) for all host device and miscellaneous defaults). If the default values suit requirements, programming is not necessary.

To set feature values, scan a single bar code or a short bar code sequence. The settings are stored in non-volatile memory and are preserved even when the device is powered down.

✓ **NOTE** Most computer monitors allow scanning the bar codes directly on the screen (when using the imaging engine). When scanning from the screen, be sure to set the document magnification to a level where you can see the bar code clearly, and bars and/or spaces are not merging.

If not using a USB cable, select a host type (see each host chapter for specific host information) after the power-up beeps sound. This is only necessary upon the first power-up when connected to a new host.

To return all features to default values, scan the [Set Default Parameter on page 5-4](#). Throughout the programming bar code menus, asterisks indicate (\*) default values.



\* Indicates Default — \*High Volume — Feature/Option  
(00h) — Option Hex Value

## Scanning Sequence Examples

In most cases, scanning one bar code sets the parameter value. For example, to set the beeper tone to high, scan the **High Frequency** (beeper tone) bar code listed under [Beeper Tone on page 5-13](#). The device issues a fast warble beep and the LED turns green, signifying a successful parameter entry.

Other parameters, such as **Serial Response Time-Out** or **Data Transmission Formats**, require scanning several bar codes. See these parameter descriptions for this procedure.

## Errors While Scanning

Unless otherwise specified, to correct an error during a scanning sequence, just re-scan the correct parameter.

## User Preferences/Miscellaneous Options Parameter Defaults

[Table 5-1](#) lists defaults for user preferences parameters. Scan the appropriate bar codes in this guide. These new values replace the standard default values in memory. To recall the default parameter values, scan the [Set Default Parameter on page 5-4](#).

✓ **NOTE** See [Appendix A, Standard Default Parameters](#) for all user preferences, hosts, symbologies, and miscellaneous default parameters.

**Table 5-1** User Preferences Parameter Defaults

Parameter	Parameter Number	Default	Page Number
<b>User Preferences</b>			
Set Default Parameter		Set Defaults	<a href="#">5-4</a>
Host Mode	F1h A4h	Cable Priority	<a href="#">5-5</a>
Decode Pager Motor Enable	F1h 65h	Disable	<a href="#">5-6</a>
Parameter Bar Code Scanning	ECh	Enable	<a href="#">5-7</a>
Scan Angle	BFh	Wide	<a href="#">5-8</a>
Adaptive Scanning	F1 CD	Enable	<a href="#">5-7</a>
Adaptive Scanning Interference Suppression Mode	F8h 04h B3h	Ambient Light Interference Suppression Auto Detection	<a href="#">5-10</a>
Adaptive Scanning Interference Suppression Scan Angle	F8h 04h DBh	Wide	<a href="#">5-11</a>
Beep After Good Decode	38h	Enable	<a href="#">5-12</a>
Beeper Tone	91h	Medium	<a href="#">5-13</a>
Beeper Volume	8Ch	High	<a href="#">5-14</a>



**Table 5-1** *User Preferences Parameter Defaults (Continued)*

Parameter	Parameter Number	Default	Page Number
Hand-Held Trigger Mode	8Ah	Standard (Level)	<a href="#">5-15</a>
Picklist Mode	F0h 92h	Disabled Always	<a href="#">5-16</a>
Decode Session Timeout	88h	9.9 Sec	<a href="#">5-15</a>
Timeout Between Decodes, Same Symbol	89h	0.5 Sec	<a href="#">5-17</a>
Hand-Held Decode Aiming Pattern	F0h 32h	Enable	<a href="#">5-17</a>
Parameter Pass Through	F1h 71h	Disable	<a href="#">5-18</a>
Decoding Illumination	F0h 2Ah	Enable	<a href="#">5-19</a>
Batch Mode	F1 20h	No Batch Mode	<a href="#">5-20</a>
FIPS Mode	F1h E0h	Disable	<a href="#">5-22</a>
DPM Scanning (MT2070-DP only)	F1h 09h	Enable	<a href="#">5-22</a>
<b>Miscellaneous Options</b>			
Transmit Code ID Character	2Dh	None	<a href="#">5-23</a>
Prefix Value	63h 69h	7013 <CR><LF>	<a href="#">5-24</a>
Suffix 1 Value Suffix 2 Value	62h 68h 64h 6Ah	7013 <CR><LF>	<a href="#">5-24</a>
Scan Data Transmission Format	EBh	Data as is	<a href="#">5-25</a>
FN1 Substitution Values	67h 6Dh	Set	<a href="#">5-26</a>
Transmit "No Read" Message	5Eh	Disable	<a href="#">5-27</a>

---

## User Preferences

### Set Default Parameter

You can reset the device to two types of defaults: factory defaults or custom defaults. Scan the appropriate bar code below to reset the decoder to its default settings and/or set its current settings as custom defaults.

✓ **NOTE** When programmed to do so, certain MT20X0 cradles send parameter updates to the scanner. For example, if the user sets up custom defaults on the scanner, these settings will be overwritten on cradle connection if Parameter Broadcast is enabled. Prior to setting custom defaults, see [Modes of Operation on page 4-19](#) and [Parameter Broadcast \(Cradle Host Only\) on page 4-20](#) to learn about cradle and scanner settings.

- **Set Defaults** - Scan this bar code to reset all default parameters as follows.
  - If you previously set custom defaults by scanning **Write to Custom Defaults**, scan **Set Defaults** to retrieve and restore the decoder's custom default settings.
  - If you did not set custom defaults, scan **Restore Defaults** to restore the factory default values listed in [Table A-1](#).
- **Set Factory Defaults** - Scan this bar code to restore the factory default values listed in [Table A-1](#). This deletes any custom defaults set.
- **Write to Custom Defaults** - Scan this bar code to set the current decoder settings as custom defaults. Once set, you can recover custom default settings by scanning **Restore Defaults**.



**\*Set Defaults**



**Set Factory Defaults**



**Write to Custom Defaults**

## Host Mode

### Parameter # F1h A4h

#### Attribute # 2A4h

The MT20X0 supports cable and Bluetooth data paths to send bar code data. Only one data path can be active.

Scanning a parameter below determines the type of host interface to use for bar code data transmission.

- In **Cable Priority** mode, the MT20X0 prioritizes a cable (USB or RS-232) as the default data path for transmitting bar code data. When a cable is not present, the MT20X0 uses the programmed Bluetooth protocol to transmit the bar code data.
- In **Cable Only** mode, the MT20X0 exclusively uses a cable (USB or RS-232) as the data path for transmitting bar code data. When a cable is not present, a transmission error occurs when scanning a bar code. **Cable Only** is not propagated to all connected devices.

✓ **NOTE** The Bluetooth radio is available for other applications such as BT Explorer.

- In **Wireless Only** mode, the MT20X0 exclusively uses the programmed Bluetooth protocol to transmit bar code data. When the user inserts a cable the MT20X0 continues to use Bluetooth as the bar code data transmission path.

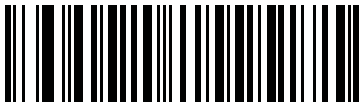

**\*Cable Priority  
(00h)**

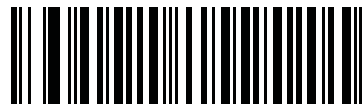

**Cable Only  
(01h)**

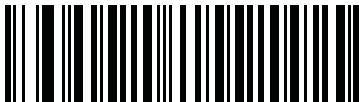

**Wireless Only  
(02h)**

## Decode Pager Motor Enable

### Parameter # F1h 65h

Attribute # 265h

Type: Bit

The MT20X0 includes a pager motor which, when enabled, vibrates the device for a period of time when a successful decode occurs.

- ✓ **NOTE** When the pager motor is enabled and the device is in IntelliStand, the pager motor disables until the device is removed from IntelliStand.

Scan a bar code below to enable or disable the pager motor.



**\*Pager Motor Disable  
(00h)**



**Pager Motor Enable  
(01h)**

## Parameter Bar Code Scanning

### Parameter # ECh

To disable the decoding of parameter bar codes, including the **Set Defaults** parameter bar codes, scan the **Disable Parameter Scanning** bar code below. To enable decoding of parameter bar codes, scan **Enable Parameter Scanning**.



\*Enable Parameter Bar Code Scanning  
(01h)



Disable Parameter Bar Code Scanning  
(00h)

## Scan Angle

### Parameter # BFh

This parameter sets the scan angle to narrow, medium, or wide.



**Narrow Angle (10°)**  
(00h)



**Medium Angle (35°)**  
(01h)



**\*Wide Angle (47°)**  
(02h)

## Adaptive Scanning

### Parameter # F1 CD

The MT20X0-MML (laser configuration) includes the SE960 scan engine with adaptive scanning. This engine uses a range finder to provide feedback on how far away a bar code is when scanning, and automatically optimizes parameters to improve decode performance. These parameters include bandwidth, receiver gain, digitizer settings and scan angle.

Scan a bar code below to enable or disable adaptive scanning.

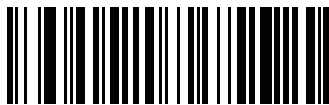

**\*Enable Adaptive Scanning  
(00h)**



**Disable Adaptive Scanning  
(01h)**

## Adaptive Scanning (continued)

### Interference Suppression Mode

#### Parameter # F8h 04h B3h

- Disable Interference Suppression: Reduced working range is possible in the presence of interfering ambient light.
- Interference Suppression Always On: Recommended only if the scanner is always in the presence of interfering ambient light.
- Ambient Light Interference Suppression Auto Detection: The scan angle changes from wide angle to medium angle in the presence of interfering ambient light, only when **Interference Suppression Scan Angle** is set to Medium (see [page 5-8](#)).



**Disable Interference Suppression  
(00h)**

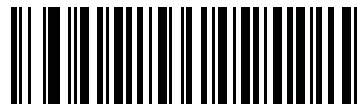

**Interference Suppression Always On  
(01h)**



**\*Ambient Light Interference Suppression  
Auto Detection  
(02h)**



## Adaptive Scanning (continued)

### Interference Suppression Scan Angle

#### Parameter # F8h 04h DBh

- Medium Interference Suppression Scan Angle: Recommended for maximum working range in the presence of interfering ambient light.
- Wide Interference Suppression Scan Angle: This is recommended for use applications where no change in scan angle is desired. Reduced working range is possible on certain bar codes in various lighting conditions. Using **Interference Suppression Scan Angle - Medium** can improve working range in these circumstances.

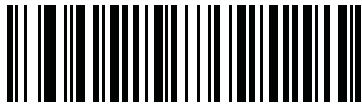

Interference Suppression Scan Angle - Medium  
(01h)

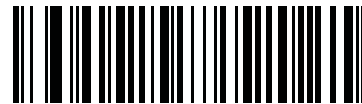

\*Interference Suppression Scan Angle - Wide  
(02h)

## Beep After Good Decode

### Parameter # 38h

Scan a bar code below to select whether or not the device beeps after a good decode. If selecting **Do Not Beep After Good Decode**, the beeper still operates during parameter menu scanning and to indicate error conditions.



\*Beep After Good Decode  
(Enable)  
(01h)

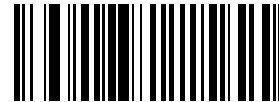

Do Not Beep After Good Decode  
(Disable)  
(00h)

## Beeper Tone

### Parameter # 91h

To select a decode beep frequency (tone), scan one of the following bar codes.



Low Tone  
(02h)



\*Medium Tone  
(01h)



High Tone  
(00h)

## Beeper Volume

### Parameter # 8Ch

To select a beeper volume, scan the **Low Volume**, **Medium Volume**, or **High Volume** bar code.



**Low Volume**  
(02h)



**Medium Volume**  
(01h)



**\*High Volume**  
(00h)

## Hand-Held Trigger Mode

### Parameter # 8Ah

Select one of the following trigger modes for the device:

- **Standard (Level)** - A trigger pull activates decode processing. Decode processing continues until the bar code decodes, you release the trigger, or the Decode Session Timeout occurs.
- **Presentation (Blink)** - The device activates decode processing when it detects a bar code in its field of view. After a period of non-use, the device enters a low power mode, in which the LEDs turn off or blink at a low duty cycle until the device senses motion.

✓ **NOTE** Laser scanning is not applicable in hand-held presentation mode.



\*Standard (Level)  
(00h)

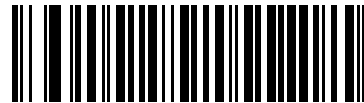

Presentation (Blink)  
(07h)

## Decode Session Timeout

### Parameter # 88h

This parameter sets the maximum time decode processing continues during a scan attempt. It is programmable in 0.1 second increments from 0.5 to 9.9 seconds. The default timeout is 9.9 seconds.

To set a Decode Session Timeout, scan the bar code below. Next, scan two numeric bar codes from [Appendix D, Numeric Bar Codes](#) that correspond to the desired on time. Enter a leading zero for single digit numbers. For example, to set a Decode Session Timeout of 0.5 seconds, scan the bar code below, then scan the **0** and **5** bar codes. To correct an error or change the selection, scan [Cancel on page D-3](#).



Decode Session Timeout

## Picklist Mode

### Parameter # F0h 92h

Picklist mode enables the device to decode only bar codes that are aligned under the laser crosshair. Select one of the following picklist modes for the device:

- **Disabled Always** - Picklist mode is always disabled.
- **Enabled in Hand-Held Mode** - Picklist mode is enabled when the device is out of hands-free mode and disabled when the device is in presentation mode.
- **Enabled in Hands-Free Mode** - Picklist mode is enabled when the device is in hands-free mode only.
- **Enabled Always** - Picklist mode is always enabled.

✓ **NOTE** If you enabled DPM Scanning on [page 5-22](#), disable Picklist Mode when scanning a DPM bar code. Picklist performance is not guaranteed for DPM bar codes.



\*Disabled Always  
(00h)



Enabled in Hand-Held Mode  
(01h)

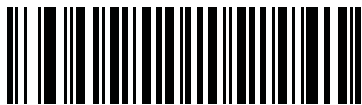

Enabled in Hands-Free Mode  
(03h)



Enabled Always  
(02h)

## Timeout Between Decodes, Same Symbol

### Parameter # 89h

Use this option in presentation mode to prevent the beeper from continuously beeping when a symbol is left in the device's field of view. It is programmable in 0.1 second increments from 0.0 to 9.9 seconds. The default interval is 0.5 seconds.

To select the timeout between decodes for the same symbol, scan the bar code below, then scan two numeric bar codes from [Appendix D, Numeric Bar Codes](#) that correspond to the desired interval, in 0.1 second increments.



Timeout Between Decodes, Same Symbol

## Hand-Held Decode Aiming Pattern

### Parameter # F0h, 32h

This parameter only applies in Decode Mode. Select **Enable Hand-Held Decode Aiming Pattern** to project the aiming pattern during 1D bar code capture; **Disable Hand-Held Decode Aiming Pattern** to turn the aiming pattern off.



**NOTE** With [Picklist Mode on page 5-16](#) enabled, the decode aiming pattern flashes even when the **Decode Aiming Pattern** is disabled.



\*Enable Hand-Held Decode Aiming Pattern  
(02h)



Disable Hand-Held Decode Aiming Pattern  
(00h)

## Parameter Pass Through

### Parameter # F1h 71h

Enable **Parameter Pass Through** to transmit bar codes in the following format, in Code 128, to the host:

<FNC3>L<any length data>

<FNC3>B<12 characters of data>

Note that the special Code 128 character <FNC3> must appear at the beginning of this data. However, if the appropriate data does not follow this as shown above, it does not transmit to the host device.



**Enable User Parameter Pass Through  
(01h)**



**\*Disable User Parameter Pass Through  
(00h)**



## Decoding Illumination (Hand-Held Mode only)

### Parameter # F0h, 2Ah

When in hand-held mode, selecting **Enable Decoding Illumination** causes the device to flash illumination to aid decoding. Select **Disable Decoding Illumination** to prevent the device from using decoding illumination.

Enabling illumination usually results in superior images. The effectiveness of the illumination decreases as the distance to the target increases.



\*Enable Decoding Illumination  
(01h)



Disable Decoding Illumination  
(00h)

## Batch Mode

### Parameter # F1 20h

#### Attribute # 544h

The device supports three versions of batch mode. When the device is configured for any of the batch modes, it attempts to store bar code data (not parameter bar codes) until transmission is initialized, or the maximum number of bar codes are stored. When a bar code is saved successfully, a good decode beep sounds and the LED flashes green. If the device is unable to store a new bar code, a low/high/low/high out of memory beep sounds. (See pages 3-1 and 3-3 for all beeper and LED definitions.)

In all modes, calculate the amount of data (number of bar codes) the device can store as follows:

$$\text{Number of storable bar codes} = 2,000 \text{ bytes of memory} / (\text{number of characters in the bar code} + 3).$$

#### Modes of Operation

- **Normal** (default) - Do not batch data. The device attempts to transmit every scanned bar code.
- **Out of Range Batch Mode** - The device starts storing bar code data when it loses its connection to a remote device (for example, when a user holding the device walks out of range). Data transmission is triggered by reestablishing the connection with the remote device (for example, when a user holding the device walks back into range).
- **Standard Batch Mode** - The device starts storing bar code data after **Enter Batch Mode** is scanned. Data transmission is triggered by scanning **Send Batch Data**.

✓ **NOTE** Transmission is halted if the connection to the remote device is lost.

- **Cradle/Cable Contact Batch Mode** - The device starts storing bar code data when **Enter Batch Mode** is scanned. Data transmission is triggered by plugging the cable into the device or inserting the device into the cradle.

In all modes, transmissions are halted if the device is moved out of range. The device resumes when it is back in range. If a bar code is scanned while batch data is transmitted it is appended to the end of the batched data; parameter bar codes are not stored.

## Batch Mode (continued)

### Parameter # 544



\*Normal  
(000h)

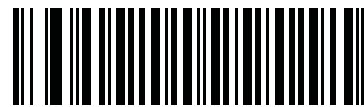

Out of Range Batch Mode  
(001h)

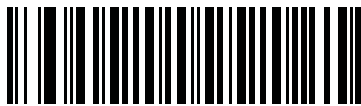

Standard Batch Mode  
(002h)

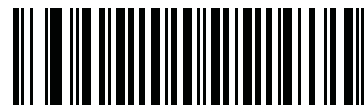

Cradle/Cable Contact Batch Mode  
(003h)

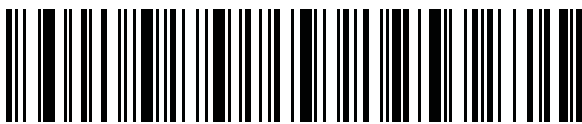

Enter Batch Mode



Send Batch Data

## FIPS Mode

### Parameter # F1h, E0h

The Federal Information Processing Standard (FIPS) 140-2 is a U.S. government computer security standard used to accredit cryptographic modules. FIPS enabled MT20X0 scanners and cradles offer this secure mode of operation.

To enable FIPS mode of operation (disabled by default), scan **Enable FIPS Mode** at any time. The scanner attempts to establish a secure session with the cradle to which it is connected. On success, the scanner lights a yellow LED on every trigger pull to signal that all data is transmitted over Bluetooth in a secure fashion. On failure, the scanner sounds an audible transmission failure error message on every attempt to transmit data.



## DPM Scanning (MT2070-DP only)

### Parameter # F1h, 09h

Unlike bar codes that are typically printed on labels, a direct part mark (DPM) is a symbol that is marked directly on an item's surface for permanent identification. These symbols are marked using methods such as laser etching and dot peening (see [Figure 3-5 on page 3-6](#) for an example of a dot peen symbol). The MT2070-DP (DPM) reader scans these types of symbols. DPM scanning is enabled by default. If you disabled DPM scanning, scan **Enable DPM Scanning** below.

- ✓ **NOTE** When the MT2070-DP is DPM enabled, the scanner reads all symbols including DPM, 1D, PDF417, etc. If you do not require DPM reading, scan **Disable DPM Scanning** to ensure optimum scanner performance.

If you enable **DPM Scanning**, disable [Picklist Mode on page 5-16](#) when scanning a DPM bar code. Picklist performance is not guaranteed for DPM bar codes.



---

## Miscellaneous Parameters

### Transmit Code ID Character

#### Parameter # 2Dh

A Code ID character identifies the code type of a scanned bar code. This is useful when decoding more than one code type. In addition to any single character prefix already selected, the Code ID character is inserted between the prefix and the decoded symbol.

Select no Code ID character, a Symbol Code ID character, or an AIM Code ID character. For Code ID Characters, see [Symbol Code Identifiers on page B-1](#) and [AIM Code Identifiers on page B-3](#).



**NOTE** If you enable Symbol Code ID Character or AIM Code ID Character, and enable [Transmit "No Read" Message on page 5-27](#), the device appends the code ID for Code 39 to the NR message.



Symbol Code ID Character  
(02h)

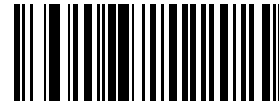

AIM Code ID Character  
(01h)



\*None  
(00h)

## Prefix/Suffix Values

**Key Category Parameter # P = 63h, S1 = 62h, S2 = 64h**

**Decimal Value Parameter # P = 69h, S1 = 68h, S2 = 6Ah**

You can append a prefix and/or one or two suffixes to scan data for use in data editing. To set a value for a prefix or suffix, scan a four-digit number (i.e., four bar codes from [Appendix D, Numeric Bar Codes](#)) that corresponds to that value. See the ASCII Character Set values in a host interface chapter (e.g., [USB Prefix/Suffix Values on page 9-20](#), [Prefix/Suffix Values on page 8-19](#), etc.) for the four-digit codes.

When using host commands to set the prefix or suffix, set the key category parameter to 1, then set the 3-digit decimal value. See ASCII Character Set values in a host interface chapter for the four-digit codes.

To correct an error or change a selection, scan [Cancel on page D-3](#).

✓ **NOTE** To use Prefix/Suffix values, [Scan Data Transmission Format on page 5-25](#) must be scanned as well.

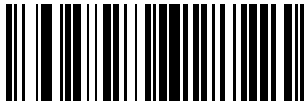

**Scan Prefix  
(07h)**

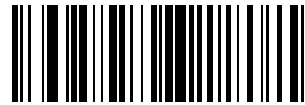

**Scan Suffix 1  
(06h)**



**Scan Suffix 2  
(08h)**



**Data Format Cancel**

## Scan Data Transmission Format

### Parameter # EBh

To change the scan data format, scan one of the following eight bar codes corresponding to the desired format.

✓ **NOTE** If using this parameter do not use ADF rules to set the prefix/suffix.

To set values for the prefix and/or suffix, see [Prefix/Suffix Values on page 5-24](#).



\*Data As Is  
(00h)



<DATA> <SUFFIX 1>  
(01h)



<DATA> <SUFFIX 2>  
(02h)



<DATA> <SUFFIX 1> <SUFFIX 2>  
(03h)



<PREFIX> <DATA >  
(04h)

## Scan Data Transmission Format (continued)



## FN1 Substitution Values

### Key Category Parameter # 67h

### Decimal Value Parameter # 6Dh

The Wedge and USB HID Keyboard hosts support a FN1 Substitution feature. Enabling this substitutes any FN1 character (0x1b) in an EAN128 bar code with a value. This value defaults to 7013 (Enter Key).

When using host commands to set the FN1 substitution value, set the key category parameter to 1, then set the 3-digit keystroke value. See the ASCII Character Set table for the current host interface for the desired value.

To select a FN1 substitution value via bar code menus:

1. Scan the bar code below.



Set FN1 Substitution Value

2. Locate the keystroke desired for FN1 Substitution in the ASCII Character Set table for the current host interface. Enter the 4-digit ASCII Value by scanning each digit in [Appendix D, Numeric Bar Codes](#).

To correct an error or change the selection, scan **Cancel**.

To enable FN1 substitution for USB HID keyboard, scan the **Enable FN1 Substitution** bar code on page [5-26](#).



## Transmit “No Read” Message

### Parameter # 5Eh

Scan a bar code below to select whether or not to transmit a No Read message. Enable this to transmit the characters NR when a bar code does not decoded. Disable this to send nothing to the host if a symbol does not decode.



**NOTE** If you enable **Transmit No Read**, and also enable Symbol Code ID Character or AIM Code ID Character for [Transmit Code ID Character on page 5-23](#), the device appends the code ID for Code 39 to the NR message.



Enable No Read  
(01h)



\*Disable No Read  
(00h)



# Chapter 6 Imaging Preferences

## Introduction

You can program the device to perform various functions, or activate different features. This chapter describes imaging preference features and provides programming bar codes for selecting these features.

The device ships with the settings in [Imaging Preferences Parameter Defaults on page 6-2](#) (also see [Appendix A, Standard Default Parameters](#) for all host device and miscellaneous defaults). If the default values suit requirements, programming is not necessary.

To set feature values, scan a single bar code or a short bar code sequence. The settings are stored in non-volatile memory and are preserved even when you power down the device.

✓ **NOTE** Most computer monitors allow scanning the bar codes directly on the screen. When scanning from the screen, be sure to set the document magnification to a level where you can see the bar code clearly, and bars and/or spaces are not merging.

If not using a USB cable, select a host type after the power-up beeps sound. See [Chapter 9, USB Interface](#) and [Chapter 8, RS-232 Interface](#) for specific host information. This is only necessary upon the first power-up when connecting to a new host.

To return all features to default values, scan the [Set Default Parameter on page 5-4](#). Throughout the programming bar code menus, asterisks (\*) indicate default values.

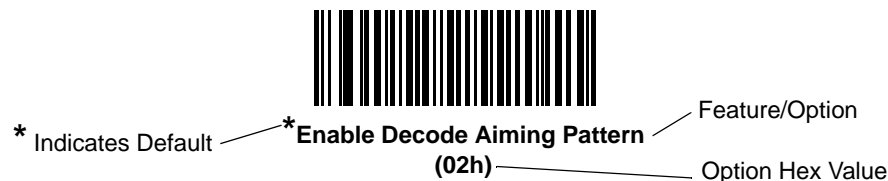

## Scanning Sequence Examples

In most cases scanning one bar code sets the parameter value. For example, to disable image capture illumination, scan the **Disable Image Capture Illumination** bar code under *Image Capture Illumination on page 6-5*. The device issues a fast warble beep and the LED turns green, signifying a successful parameter entry.

Other parameters require scanning several bar codes. See these parameter descriptions for this procedure.

## Errors While Scanning

Unless otherwise specified, to correct an error during a scanning sequence, just re-scan the correct parameter.

## Imaging Preferences Parameter Defaults

*Table 6-1* lists the defaults for imaging preferences parameters. Scan the appropriate bar codes in this guide. These new values replace the standard default values in memory. To recall the default parameter values, scan the *Set Default Parameter on page 5-4*.

✓ **NOTE** See *Appendix A, Standard Default Parameters* for all user preferences, hosts, symbologies, and miscellaneous default parameters.

**Table 6-1** *Imaging Preferences Parameter Defaults*

Parameter	Parameter Number	Default	Page Number
<b>Imaging Preferences</b>			
Operational Modes	N/A	N/A	6-4
Image Capture Illumination	F0h 69h	Enable	6-5
Snapshot Mode Timeout	F0h 43h	0 (30 seconds)	6-6
Snapshot Aiming Pattern	F0h 2Ch	Enable	6-6
Image Cropping	F0h 2Dh	Disable	6-7
Crop to Pixel Addresses	F4h F0h 3Bh; F4h F0h 3Ch; F4h F0h 3Dh; F4h F0h 3Eh	0 top, 0 left, 1023 bottom, 1279 right	6-8
Image Brightness (Target White)	F0h 86h	180	6-9
JPEG Quality and Size Value	F0h 31h	65	6-9
Image File Format Selection	F0h 30h	JPEG	6-10
Signature Capture	5Dh	Disable	6-11
Signature Capture Image File Format Selection	F0h 39h	JPEG	6-12

**Table 6-1** *Imaging Preferences Parameter Defaults (Continued)*

<b>Parameter</b>	<b>Parameter Number</b>	<b>Default</b>	<b>Page Number</b>
Signature Capture Width	F4h F0h 6Eh	400	<a href="#">6-13</a>
Signature Capture Height	F4h F0h 6Fh	100	<a href="#">6-13</a>
Signature Capture JPEG Quality	F0h A5h	65	<a href="#">6-13</a>
Video View Finder	F0h 44h	Disable	<a href="#">6-14</a>

## Imaging Preferences

The parameters in this chapter control image capture characteristics. Image capture occurs in all modes of operation, including decode and snapshot.

### Operational Modes

The device has two modes of operation:

- Decode Mode
- Snapshot Mode.

#### Decode Mode

By default, when you pull the trigger the device attempts to locate and decode enabled bar codes within its field of view. The device remains in this mode until it decodes a bar code or you release the trigger.

#### Snapshot Mode



**IMPORTANT** Before scanning **Snapshot Mode**, scan the [Symbol Native API \(SNAPI\) with Imaging Interface on page 9-6](#). The SNAPI with Imaging USB interface supports picture taking. Non-imaging USB interfaces are invalid in snapshot mode.

Use Snapshot Mode to capture a high-quality image and transmit it to the host. While in this mode the device blinks the green LED at 1-second intervals to indicate it is not in standard operating (decode) mode.

In Snapshot Mode, the device turns on its laser aiming pattern to highlight the area to capture in the image. The next trigger pull instructs the device to capture a high quality image and transmit it to the host. A short time may pass (less than 2 seconds) between when the trigger is pulled and the image is captured as the device adjusts to the lighting conditions. Hold the device steady until the image is captured, denoted by a single beep.

If you do not press the trigger within the Snapshot Mode Timeout period, the device returns to Decode Mode. Use [Snapshot Mode Timeout on page 6-6](#) to adjust this timeout period. The default timeout period is 30 seconds.

To disable the laser aiming pattern during Snapshot Mode, see [Snapshot Aiming Pattern on page 6-6](#).



**NOTE** Refer to the EMDK for the Snapshot Mode API.

## Image Capture Illumination

### Parameter # F0h 69h

Selecting **Enable Image Capture Illumination** causes illumination to turn on during every image capture. Disable illumination to prevent the device from using illumination.

Enabling illumination usually results in superior images. The effectiveness of illumination decreases as the distance to the target increases.

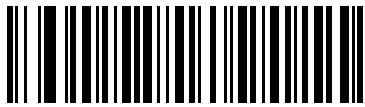

**\*Enable Image Capture Illumination  
(01h)**



**Disable Image Capture Illumination  
(00h)**

## Snapshot Mode Timeout

### Parameter # F0h, 43h

This parameter sets the amount of time the device remains in Snapshot Mode. The device exits Snapshot Mode when you pull the trigger, or when the Snapshot Mode Timeout elapses. To set this timeout value, scan the bar code below followed by a bar code from [Appendix D, Numeric Bar Codes](#). The default value is 0 which represents 30 seconds; values increment by 30. For example, 1 = 60 seconds, 2 = 90 seconds, etc.



Snapshot Mode Timeout

## Snapshot Aiming Pattern

### Parameter # F0h, 2Ch

Select **Enable Snapshot Aiming Pattern** to project the aiming pattern when in Snapshot Mode, or **Disable Snapshot Aiming Pattern** to turn the aiming pattern off.



\*Enable Snapshot Aiming Pattern  
(01h)



Disable Snapshot Aiming Pattern  
(00h)



## Image Cropping

### Parameter # F0h, 2Dh

This parameter crops a captured image. Select **Disable Image Cropping** to present the full 752 x 480 pixels. Select **Enable Image Cropping** to crop the image to the pixel addresses set in [Crop to Pixel Addresses on page 6-8](#).

- ✓ **NOTE** The device has a cropping resolution of 4 pixels. Setting a pixel address of 0 for Bottom and Right (with Top and Left set to the default 0) transfers the entire image. Setting the cropping area to greater than 0, but less than 4, sets the value to the minimum 4 pixels.



**Enable Image Cropping  
(01h)**



**\*Disable Image Cropping  
(Use Full 752 x 480 Pixels)  
(00h)**

## Crop to Pixel Addresses

**Parameter # F4h, F0h, 3Bh (Top)**

**Parameter # F4h, F0h, 3Ch (Left)**

**Parameter # F4h, F0h, 3Dh (Bottom)**

**Parameter # F4h, F0h, 3Eh (Right)**

If you selected **Enable Image Cropping**, set the pixel addresses from (0,0) to (751,479) to crop to.

Columns are numbered from 0 to 751, rows from 0 to 479. Specify four values for Top, Left, Bottom, and Right, where Top and Bottom correspond to row pixel addresses, and Left and Right correspond to column pixel addresses. For example, for a 4 row x 8 column image in the extreme bottom-right section of the image set the following values:

Top = 476, Bottom = 479, Left = 744, Right = 751

To set the crop to pixel address, scan each pixel address bar code below followed by three numeric bar codes representing the value. Leading zeros are required. For example, to crop the top pixel address to 3, scan 0, 0, 3. See [Appendix D, Numeric Bar Codes](#) for numeric bar codes.

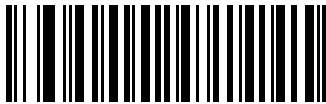

**Top Pixel Address**  
(0 - 479 Decimal)

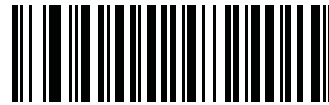

**Left Pixel Address**  
(0 - 751 Decimal)

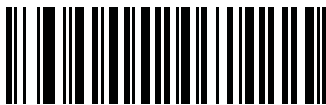

**Bottom Pixel Address**  
(0 - 479 Decimal)

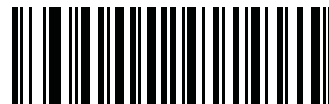

**Right Pixel Address**  
(0 - 751 Decimal)

## Image Brightness (Target White)

### Parameter # F0h 86h

Type: Byte

Range: 1 - 240

This parameter sets the Target White value used in Snapshot, Video and Video Viewfinder mode when using auto exposure. White and black are defined as 255 decimal and 0, respectively. Setting the value to the factory default of 180 sets the white level of the image to ~180.

To set the Image Brightness parameter, scan **Image Brightness** below followed by three numeric bar codes representing the value. Leading zeros are required. For example, to set an Image Brightness value of 99, scan 0, 9, 9. See [Appendix D, Numeric Bar Codes](#) for numeric bar codes.



\*180



Image Brightness  
(3 digits)

## JPEG Quality and Size Value

### JPEG Quality = Parameter # F0h, 31h

If you selected **JPEG Quality Selector**, scan the **JPEG Quality Value** bar code followed by 3 bar codes from [Appendix D, Numeric Bar Codes](#) corresponding to a value from 5 to 100, where 100 represents the highest quality image.



JPEG Quality Value  
(Default: 065)  
(5 - 100 Decimal)

## Image File Format Selector



**IMPORTANT** Before entering snapshot mode to take pictures with the device, ensure the device is set up to interface with a USB connection via the [Symbol Native API \(SNAPI\) with Imaging Interface on page 9-6](#). The SNAPI with Imaging USB interface supports picture taking and BMP, JPEG and TIFF file formats. Non-imaging USB interfaces are invalid in snapshot mode.

### Parameter # F0h, 30h

Select an image format appropriate for the system (BMP, TIFF, or JPEG). The device stores captured images in the selected format.



**BMP File Format  
(03h)**



**\*JPEG File Format  
(01h)**



**TIFF File Format  
(04h)**

## Signature Capture

### Parameter # 5Dh

A signature capture bar code is a special-purpose symbology which delineates a signature capture area in a document with a machine-readable format. The recognition pattern is variable so it can optionally provide an index to various signatures. The region inside the bar code pattern is considered the signature capture area.

### Output File Format

Decoding a signature capture bar code de-skews the signature image and converts the image to a BMP, JPEG, or TIFF file format. The output data includes the file descriptor followed by the formatted signature image.

File Descriptor			Signature Image
Output Format (1 byte)	Signature Type (1 byte)	Signature Image Size (4 bytes) (BIG Endian)	
JPEG - 1 BMP - 3 TIFF - 4	1-8	0x00000400	0x00010203....

To enable or disable Signature Capture, scan the appropriate bar code below.



**Enable Signature Capture  
(01h)**



**\*Disable Signature Capture  
(00h)**

## Signature Capture File Format Selector

### Parameter # F0h, 39h

Select a signature file format appropriate for the system (BMP, TIFF, or JPEG). The device stores captured signatures in the selected format.



**BMP Signature Format  
(03h)**



**\*JPEG Signature Format  
(01h)**



**TIFF Signature Format  
(04h)**

## Signature Capture Width

### Parameter # F4h, F0h, 6Eh

The aspect ratio of the Signature Capture Width and Signature Capture Height parameters must match that of the signature capture area. For example, a 4 x 1 inch signature capture area would require a 4 to 1 aspect ratio of width to height.

To set the width of the signature capture box, scan the **Signature Capture Width** bar code, followed by 3 bar codes from [Appendix D, Numeric Bar Codes](#) corresponding to a value in the range of 001 to 752 decimal.



**Signature Capture Width**  
(Default: 400)  
(001 - 752 Decimal)

## Signature Capture Height

### Parameter # F4h, F0h, 6Fh

To set the height of the signature capture box, scan the **Signature Capture Height** bar code, followed by 3 bar codes from [Appendix D, Numeric Bar Codes](#) corresponding to a value in the range of 001 to 480 decimal.



**Signature Capture Height (Default: 100)**  
(001 - 480 Decimal)

## Signature Capture JPEG Quality

### Parameter # F0h, A5h

Scan the **JPEG Quality Value** bar code followed by 3 bar codes from [Appendix D, Numeric Bar Codes](#) corresponding to a value from 005 to 100, where 100 represents the highest quality image.



**JPEG Quality Value (Default: 065)**  
(5 - 100 Decimal)

## Video View Finder

### Parameter # F0h, 44h

Select **Enable Video View Finder** to project the video view finder while in Video Mode, or **Disable Video View Finder** to turn the video view finder off.

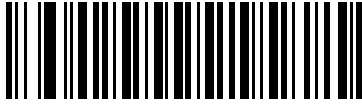

\*Disable Video View Finder  
(00h)

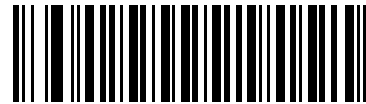

Enable Video View Finder  
(01h)



# Chapter 7 Customizing the MT20X0

---

## Introduction

This chapter includes information about customizing the MT20X0 for the end user. By default, the device launches the shell program, *Navigator.exe*, which provides access to default demonstration applications. The *out-of-the-box* view and startup was selected to demonstrate the capabilities of the device and is not intended to be used by end users. It is highly recommended that the view of selected programs be altered to prevent tampering.

The following device programs and screens can be customized:

- default startup program
- *Home* screen/shell (*Navigator.exe*) view
- *Scan Item* or *Scan Inventory* program
- disable MT200X Scanner Services.

---

## Customizing the Startup Program

By default, *Navigator.exe* is selected as the startup program. This program provides the *Home* screen view and accessibility to the demonstration/configuration applications such as:

- Scan Item
- Scan Inventory
- File Explorer
- Task Manager
- MCL Client
- Wireless Companion (MT2090 Only).

Although the demonstration/configuration applications are very useful for presentations, they may not be appropriate for the end user (e.g., having access to all programs in addition to the customer designated program requirements). For this purpose, simple customization of the `\Application\Startup\StartMenu.Run` file can alter the default startup application.

For example, to launch MCL as the default application instead of *Navigator.exe*, alter the contents of `StartMenu.Run` by changing:

```
\windows\Navigator.exe
```

to:

```
\Application\MCL\StartMCL.exe
```

The new startup application takes affect when the device restarts via a cold or warm boot.

## Customizing the Home Screen View

By default, the initial view on the MT20X0 is the *Home* screen.

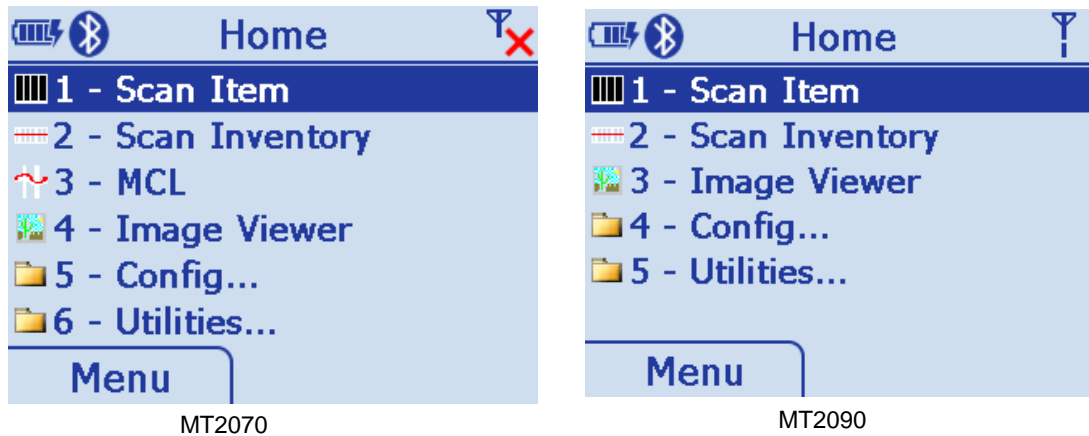

**Figure 7-1** Home Screen

The contents of the *Home* screen (*Navigator.exe*) are driven by an XML file named *Navigator.xml* which resides in the *\Platform* folder on the device.

[Table 7-1](#) lists the schema, or format, for the *Navigator.xml* file.

**Table 7-1** *Navigator.xml* Schema

Tag	Description
<Navigator>	The root element of the Navigator schema.
<title>	Title of Navigator schema - not used by the application.
<show_images>	Used to show or hide icons.
<show_numbers>	Used to show or hide numbers.
<allow_exit>	Used to enable/disable the <b>Close</b> button.
<menu>	Used to child element collection of <item> in a menu or submenu.
<item>	Used to define a child element which contains a <name> and <command> or <name> <menu> collection.
<name>	Displayed name of item element in <i>Navigator.exe</i>
<command>	Command line to execute when item is selected and <b>Enter</b> key or hot key number is pressed.

## Navigator.xml File Content

```

<?xml version="1.0" encoding="utf-8"?>
<navigator>
  <title>Navigator</title>
  <show_images>true</show_images>
  <show_numbers>true</show_numbers>
  <allow_exit>>false</allow_exit>
  <menu>
    <item>
      <name>Scan Item</name>
      <command>\Windows\ScanItem.exe</command>
    </item>
    <item>
      <name>Scan Inventory</name>
      <command>\Windows\ScanInventory.exe</command>
    </item>
    <item>
      <name>MCL</name>
      <command>\application\MCL\startmcl.exe</command>
    </item>
    <item>
      <name>Image Viewer</name>
      <command>\Windows\ImagerSampleMT.exe</command>
    </item>
    <item>
      <name>Config...</name>
      <menu>
        <item>
          <name>Scanner Settings</name>
          <command>\Windows\Settings.exe</command>
        </item>
        <item>
          <name>Rapid Deployment</name>
          <command>\Windows\rdclient.exe</command>
        </item>
        <item>
          <name>MSP Agent</name>
          <command>\windows\30agent.exe -U</command>
        </item>
        <item>
          <name>BT Explorer</name>
          <command>\Platform\BTEXPLORER\BTEplorer.exe</command>
        </item>
      </menu>
    </item>
    <item>
      <name>Configure USB</name>
      <command>\Windows\USBFunctionSwitch.exe</command>
    </item>
  </menu>
  </item>
  <item>
    <name>Utilities...</name>
    <menu>
      <item>
        <name>File Explorer</name>
        <command>\Windows\FileExplorer.exe</command>
      </item>
      <item>
        <name>Task Manager</name>
        <command>\Windows\TaskManager.exe</command>
      </item>
    </menu>
  </item>
</menu>
</navigator>

```

---

## Customizing the Scan Item or Scan Inventory Program

The demonstration applications, *ScanItem.exe* and *ScanInventory.exe* are available through the EMDK for the MT2000 Series devices. These applications use the MT2000 Series device specific assemblies and are available in both C# and VB.NET under Visual Studio 2005 and 2008.

The EMDK can be found at: <http://www.zebra.com/support>. Select *Software Downloads*.

## Disabling MT2000 Scanner Services

In some cases, developers may choose to disable MT2000 Scanner Services which enables hand-held scan and transmit operation on a Windows CE 5.0 device. When disabled, *ScanItem.exe* and *ScanInventory.exe* applications do not operate. In addition, connection to the STB2078 cradle, the Bluetooth-to-computer bridge, can not operate as it relies on MT2000 Scanner Services to implement the necessary communications.



**IMPORTANT** Disable MT2000 Scanner Services only when the MT20X0 is used as a mobile computing device.

To disable MT2000 Scanner Services:

1. Access the */Platform* folder on the device via *File Explorer*.
2. Delete the *ADCServices.reg* file.

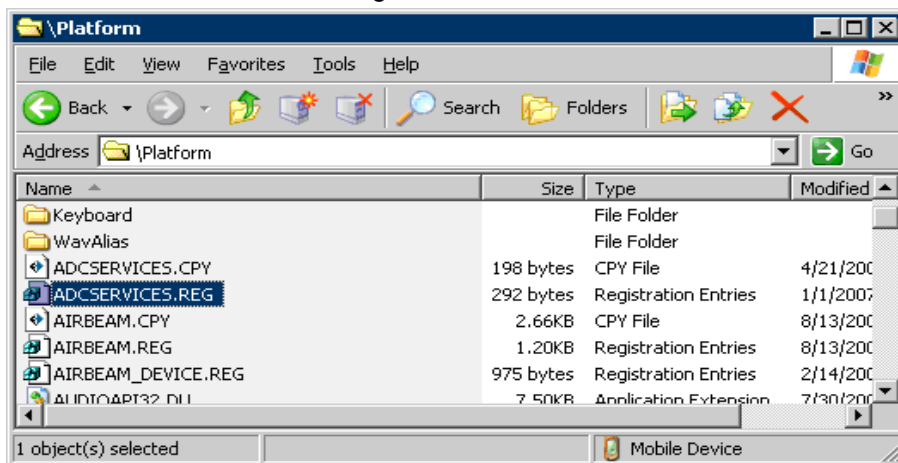

Alternately, you can also stop MT2000 Scanner Services from running programmatically by issuing the `ADCAPI_StopService()` C API. For more information, refer to the EMDK for C version documentation.

# Chapter 8 RS-232 Interface

## Introduction

This chapter describes how to set up the device with an RS-232 host. Use the RS-232 interface to connect the device to point-of-sale devices, host computers, or other devices with an available RS-232 port (e.g., com port).

If your host does not appear in [Table 8-2](#), refer to the documentation for the host device to set communication parameters to match the host.

- ✓ **NOTE** The device uses TTL RS-232 signal levels, which interface with most system architectures. For system architectures requiring RS-232C signal levels, Zebra offers different cables providing TTL-to-RS-232C conversion. Contact Zebra Support for more information.

Throughout the programming bar code menus, asterisks (\*) indicate default values.



\* Indicates Default — \*Baud Rate 57,600 — Feature/Option

- ✓ **NOTE** Most computer monitors allow scanning the bar codes directly on the screen. When scanning from the screen, be sure to set the document magnification to a level where you can see the bar code clearly, and bars and/or spaces are not merging.

## Connecting an RS-232 Interface

Connect the device directly to the host computer.

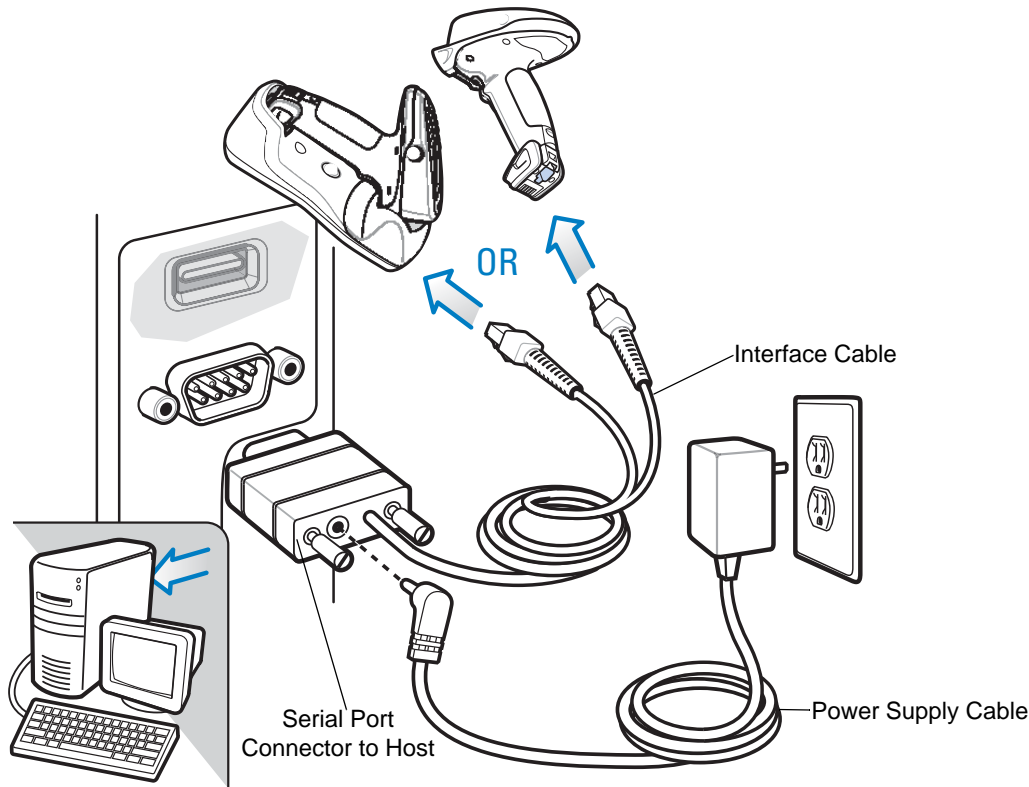

**Figure 8-1** RS-232 Direct Connection

✓ **NOTE** Interface cables vary depending on configuration. The connectors illustrated in [Figure 8-1](#) are examples only. The connectors may be different than those illustrated, but the steps to connect the device are the same.

✓ **NOTE** Connect a power supply to the cradle (not shown) for fast charging.

1. Attach the modular connector of the RS-232 interface cable to the cable interface port on the device.
2. Connect the other end of the RS-232 interface cable to the serial port on the host.
3. Connect the power supply to the serial connector end of the RS-232 interface cable. Plug the power supply into an appropriate outlet.
4. Select the RS-232 host type by scanning the appropriate bar code from [RS-232 Host Types on page 8-6](#).
5. To modify any other parameter options, scan the appropriate bar codes in this chapter.



## RS-232 Parameter Defaults

[Table 8-1](#) lists the defaults for RS-232 host parameters. To change any option, scan the appropriate bar code(s) provided in the RS-232 Host Parameters section beginning on page [8-4](#).

✓ **NOTE** See [Appendix A, Standard Default Parameters](#) for all user preferences, hosts, symbologies, and miscellaneous default parameters.

**Table 8-1** RS-232 Host Default Table

Parameter	Default	Page Number
<b>RS-232 Host Parameters</b>		
RS-232 Host Types	Standard	<a href="#">8-6</a>
Baud Rate	9600	<a href="#">8-7</a>
Parity Type	None	<a href="#">8-9</a>
Stop Bit Select	1 Stop Bit	<a href="#">8-10</a>
Data Bits	8-Bit	<a href="#">8-10</a>
Check Receive Errors	Enable	<a href="#">8-11</a>
Hardware Handshaking	None	<a href="#">8-11</a>
Software Handshaking	None	<a href="#">8-13</a>
Host Serial Response Time-out	2 Sec	<a href="#">8-15</a>
RTS Line State	Low RTS	<a href="#">8-16</a>
Beep on <BEL>	Disable	<a href="#">8-16</a>
Intercharacter Delay	0 msec	<a href="#">8-17</a>
Nixdorf Beep/LED Options	Normal Operation	<a href="#">8-18</a>
Ignore Unknown Characters	Send Bar Code	<a href="#">8-18</a>

## RS-232 Host Parameters

Various RS-232 hosts use their own parameter default settings. Selecting standard, ICL, Fujitsu, Wincor-Nixdorf Mode A, Wincor-Nixdorf Mode B, OPOS/JPOS, Olivetti, or Omron sets the defaults listed in [Table 8-2](#).

**Table 8-2** Terminal Specific RS-232

Parameter	ICL	Fujitsu	Wincor-Nixdorf Mode A	Wincor-Nixdorf Mode B/OPOS/JPOS	Olivetti	Omron
Transmit Code ID	Yes	Yes	Yes	Yes	Yes	Yes
Data Transmission Format	Data/Suffix	Data/Suffix	Data/Suffix	Data/Suffix	Prefix/Data/Suffix	Data/Suffix
Suffix	CR (1013)	CR (1013)	CR (1013)	CR (1013)	ETX (1002)	CR (1013)
Baud Rate	9600	9600	9600	9600	9600	9600
Parity	Even	None	Odd	Odd	Even	None
Hardware Handshaking	RTS/CTS Option 3	None	RTS/CTS Option 3	RTS/CTS Option 3	None	None
Software Handshaking	None	None	None	None	Ack/Nak	None
Serial Response Time-out	9.9 Sec.	2 Sec.	9.9 Sec.	9.9 Sec.	9.9 Sec.	9.9 Sec.
Stop Bit Select	One	One	One	One	One	One
ASCII Format	8-Bit	8-Bit	8-Bit	8-Bit	7-Bit	8-Bit
Beep On <BEL>	Disable	Disable	Disable	Disable	Disable	Disable
RTS Line State	High	Low	Low	Low = No data to send	Low	High
Prefix	None	None	None	None	STX (1003)	None

**\*In the Nixdorf Mode B, if CTS is low, scanning is disabled. When CTS is high, scanning is enabled.**

**\*\* If you scan Nixdorf Mode B without connecting the device to the proper host, it may appear unable to scan. If this happens, scan a different RS-232 host type within 5 seconds of cycling power to the device.**

## RS-232 Host Parameters (continued)

Selecting ICL, Fujitsu, Wincor-Nixdorf Mode A, Wincor-Nixdorf Mode B, OPOS/JPOS, Olivetti, or Omron enables the transmission of code ID characters listed in [Table 8-3](#). These code ID characters are not programmable and are separate from the Transmit Code ID feature. Do not enable the Transmit Code ID feature for these terminals.

**Table 8-3** Terminal Specific Code ID Characters

Code Type	ICL	Fujitsu	Wincor-Nixdorf Mode A	Wincor-Nixdorf Mode B/ OPOS/JPOS	Olivetti	Omron
UPC-A	A	A	A	A	A	A
UPC-E	E	E	C	C	C	E
EAN-8/JAN-8	FF	FF	B	B	B	FF
EAN-13/JAN-13	F	F	A	A	A	F
Code 39	C <len>	None	M	M	M <len>	C <len>
Code 39 Full ASCII	None	None	M	M	None	None
Codabar	N <len>	None	N	N	N <len>	N <len>
Code 128	L <len>	None	K	K	K <len>	L <len>
I 2 of 5	I <len>	None	I	I	I <len>	I <len>
Code 93	None	None	L	L	L <len>	None
D 2 of 5	H <len>	None	H	H	H <len>	H <len>
GS1-128	L <len>	None	P	P	P <len>	L <len>
MSI	None	None	O	O	O <len>	None
Bookland EAN	F	F	A	A	A	F
Trioptic	None	None	None	None	None	None
Code 11	None	None	None	None	None	None
IATA	H<len>	None	H	H	None	None
Code 32	None	None	None	None	None	None
GS1 Databar Variants	None	None	E	E	None	None
PDF417	None	None	Q	Q	None	None
Datamatrix	None	None	R	R	None	None
QR Codes	None	None	U	U	None	None
Aztec/Aztec Rune	None	None	V	V	None	None
Micro PDF	None	None	S	S	None	None
Maxicode	None	None	T	T	None	None

## RS-232 Host Types

To select an RS-232 host interface, scan one of the following bar codes.

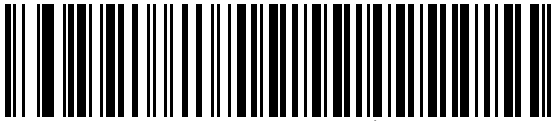

Standard RS-232<sup>1</sup>

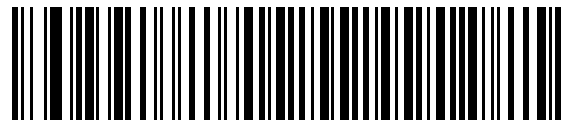

ICL RS-232

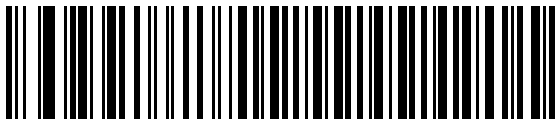

Wincor-Nixdorf RS-232 Mode A

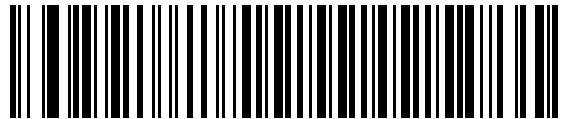

Wincor-Nixdorf RS-232 Mode B

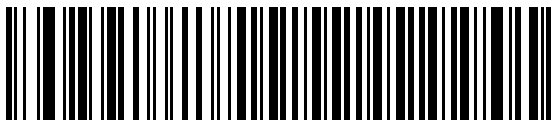

Olivetti ORS4500

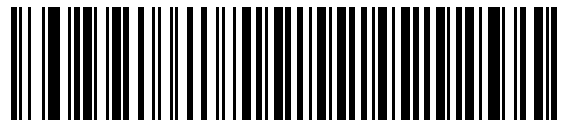

Omron

<sup>1</sup>Scanning Standard RS-232 activates the RS-232 driver, but does not change port settings (e.g., parity, data bits, handshaking). Selecting another RS-232 host type bar code changes these settings.

## RS-232 Host Types (continued)

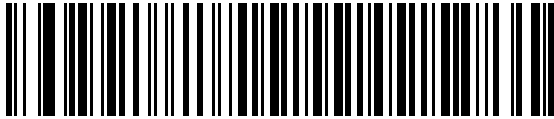

OPOS/JPOS

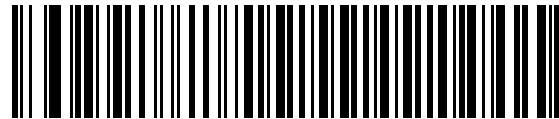

Fujitsu RS-232

## Baud Rate

Baud rate is the number of bits of data transmitted per second. Set the device's baud rate to match the baud rate setting of the host device. Otherwise, data may not reach the host device or may reach it in distorted form.



Baud Rate 600



Baud Rate 1200



Baud Rate 2400



Baud Rate 4800

### Baud Rate (continued)



\*Baud Rate 9600



Baud Rate 19,200



Baud Rate 38,400



Baud Rate 57,600



Baud Rate 115,200

## Parity

A parity check bit is the most significant bit of each ASCII coded character. Select the parity type according to host device requirements.

- Select **Odd** parity to set the parity bit value to 0 or 1, based on data, to ensure that the coded character contains an odd number of 1 bits.
- Select **Even** parity to set the parity bit value is set to 0 or 1, based on data, to ensure that the coded character contains an even number of 1 bits.
- Select **None** when no parity bit is required.

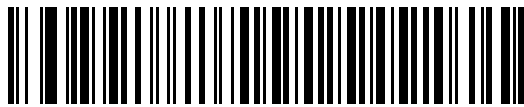

Odd

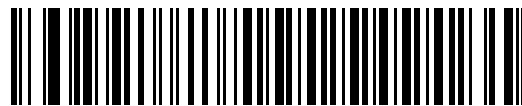

Even



\*None

## Stop Bit Select

The stop bit(s) at the end of each transmitted character marks the end of transmission of one character and prepares the receiving device for the next character in the serial data stream. Select the number of stop bits (one or two) based on the number the receiving terminal is programmed to accommodate. Set the number of stop bits to match host device requirements.



\*1 Stop Bit



2 Stop Bits

## Data Bits

This parameter allows the device to interface with devices requiring a 7-bit or 8-bit ASCII protocol.



7-Bit

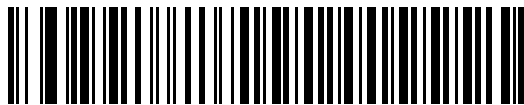

\* -Bit



## Check Receive Errors

Select whether or not to check the parity, framing, and overrun of received characters. The parity value of received characters is verified against the parity parameter selected above.

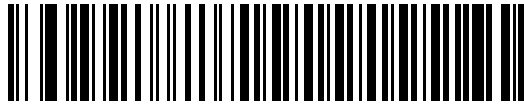

\*Check For Received Errors



Do Not Check For Received Errors

## Hardware Handshaking

The data interface consists of an RS-232 port designed to operate either with or without the hardware handshaking lines, *Request to Send* (RTS), and *Clear to Send* (CTS).

Disable Standard RTS/CTS handshaking to transmit scan data as it becomes available. Select Standard RTS/CTS handshaking to transmit scan data according to the following sequence:

- The device reads the CTS line for activity. If CTS is asserted, the device waits up to Host Serial Response Time-out for the host to de-assert the CTS line. If, after Host Serial Response Time-out (default), the CTS line is still asserted, the device sounds a transmit error, and discards any scanned data.
- When the CTS line is de-asserted, the device asserts the RTS line and waits up to Host Serial Response Time-out for the host to assert CTS. When the host asserts CTS, the device transmits data. If, after Host Serial Response Time-out (default), the CTS line is not asserted, the device sounds a transmit error, and discards the data.
- When data transmission completes, the device de-asserts RTS 10 msec after sending the last character.
- The host should respond by negating CTS. The device checks for a de-asserted CTS upon the next transmission of data.

During the transmission of data, the CTS line should be asserted. If CTS is deasserted for more than 50 ms between characters, the device aborts transmission, sounds a transmission error, and discards the data.

If this communication sequence fails, the device issues an error indication. In this case, the data is lost and must be rescanned.

If hardware handshaking and software handshaking are both enabled, hardware handshaking takes precedence.

✓ **NOTE** The DTR signal is jumpered to the active state.

## Hardware Handshaking (continued)

- **None:** Scan this bar code to disable hardware handshaking.
- **Standard RTS/CTS:** Scan this bar code to select Standard RTS/CTS Hardware Handshaking.
- **RTS/CTS Option 1:** If you select RTS/CTS Option 1, the device asserts RTS before transmitting and ignores the state of CTS. The device de-asserts RTS when the transmission completes.
- **RTS/CTS Option 2:** If you select Option 2, RTS is always high or low (user-programmed logic level). However, the device waits for CTS to be asserted before transmitting data. If CTS is not asserted within Host Serial Response Time-out (default), the device issues an error indication and discards the data.
- **RTS/CTS Option 3:** If you select Option 3, the device asserts RTS prior to any data transmission, regardless of the state of CTS. The device waits up to Host Serial Response Time-out (default) for CTS to be asserted. If CTS is not asserted during this time, the device issues an error indication and discards the data. The device de-asserts RTS when transmission is complete.



\*None



Standard RTS/CTS



RTS/CTS Option 1



RTS/CTS Option 2



RTS/CTS Option 3

## Software Handshaking

This parameter offers control of the data transmission process in addition to, or instead of, that offered by hardware handshaking. There are five options.

If software handshaking and hardware handshaking are both enabled, hardware handshaking takes precedence.

- **None:** Select this to transmit data immediately. The device expects no response from the host.
- **ACK/NAK:** If you select this option, after transmitting data, the device expects either an ACK or NAK response from the host. When it receives a NAK, the device transmits the same data again and waits for either an ACK or NAK. After three unsuccessful attempts to send data after receiving NAKs, the device issues an error indication and discards the data.

The device waits up to the programmable Host Serial Response Time-out to receive an ACK or NAK. If the device does not get a response in this time, it issues an error indication and discards the data. There are no retries when a time-out occurs.

- **ENQ:** If you select this option, the device waits for an ENQ character from the host before transmitting data. If it does not receive an ENQ within the Host Serial Response Time-out, the device issues an error indication and discards the data. The host must transmit an ENQ character at least every Host Serial Response Time-out to prevent transmission errors.
- **ACK/NAK with ENQ:** This combines the two previous options. For re-transmissions of data, due to a NAK from the host, an additional ENQ is not required.
- **XON/XOFF:** An XOFF character turns the device transmission off until the device receives an XON character. There are two situations for XON/XOFF:
  - The device receives an XOFF before has data to send. When the device has data to send, it waits up to Host Serial Response Time-out for an XON character before transmission. If it does not receive the XON within this time, the device issues an error indication and discards the data.
  - The device receives an XOFF during a transmission. Data transmission then stops after sending the current byte. When the device receives an XON character, it sends the rest of the data message. The device waits indefinitely for the XON.

### Software Handshaking (continued)



\*None

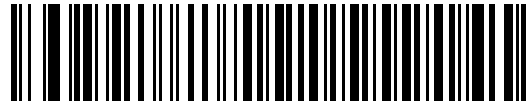

ACK/NAK

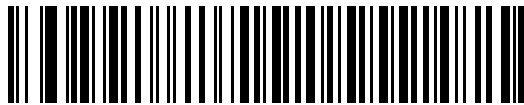

ENQ



ACK/NAK with ENQ



XON/XOFF

## Host Serial Response Time-out

This parameter specifies how long the device waits for an ACK, NAK, or CTS before determining that a transmission error occurred. This only applies when in one of the ACK/NAK software handshaking modes, or RTS/CTS hardware handshaking mode.



\*Minimum: 2 Sec



Low: 2.5 Sec

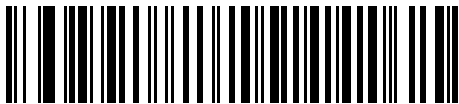

Medium: 5 Sec



High: 7.5 Sec

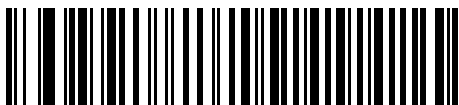

Maximum: 9.9 Sec

## RTS Line State

This parameter sets the idle state of the Serial Host RTS line. Scan a bar code below to select **Low RTS** or **High RTS** line state.



\*Host: Low RTS



Host: High RTS

## Beep on <BEL>

If you enable this parameter, the device issues a beep when it detects a <BEL> character on the RS-232 serial line. <BEL> indicates an illegal entry or other important event.



Beep On <BEL> Character  
(Enable)



\*Do Not Beep On <BEL> Character  
(Disable)

## Intercharacter Delay

This parameter specifies the intercharacter delay inserted between character transmissions.



\*Minimum: 0 msec



Low: 25 msec

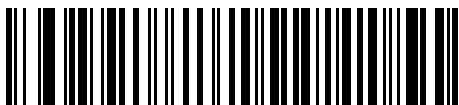

Medium: 50 msec



High: 75 msec

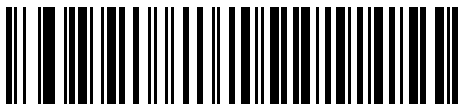

Maximum: 99 msec

## Nixdorf Beep/LED Options

If you selected Nixdorf Mode B, this indicates when the device beeps and turns on its LED after a decode.

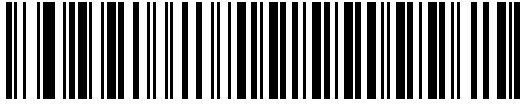

**\*Normal Operation**  
(Beep/LED immediately after decode)



**Beep/LED After Transmission**

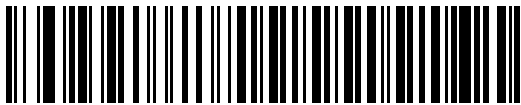

**Beep/LED After CTS Pulse**

## Ignore Unknown Characters

Unknown characters are characters the host does not recognize. Select **Send Bar Codes with Unknown Characters** to send all bar code data except for unknown characters. The device issues no error beeps.

Select **Do Not Send Bar Codes With Unknown Characters** to send bar code data up to the first unknown character. The device issues an error beep.

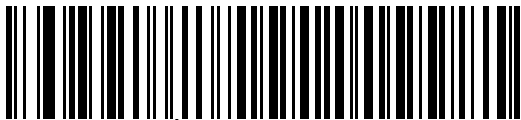

**\*Send Bar Code**  
(with unknown characters)

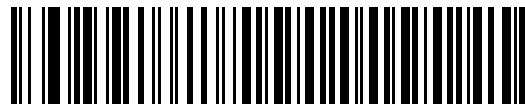

**Do Not Send Bar Codes**  
(with unknown characters)



## ASCII Character Set for RS-232

You can assign the values in [Table 8-4](#) as prefixes or suffixes for ASCII character data transmission.

**Table 8-4** *Prefix/Suffix Values*

Prefix/Suffix Value	Full ASCII Code 39 Encode Character	ASCII Character
1000	%U	NUL
1001	\$A	SOH
1002	\$B	STX
1003	\$C	ETX
1004	\$D	EOT
1005	\$E	ENQ
1006	\$F	ACK
1007	\$G	BELL
1008	\$H	BCKSPC
1009	\$I	HORIZ TAB
1010	\$J	LF/NW LN
1011	\$K	VT
1012	\$L	FF
1013	\$M	CR/ENTER
1014	\$N	SO
1015	\$O	SI
1016	\$P	DLE
1017	\$Q	DC1/XON
1018	\$R	DC2
1019	\$S	DC3/XOFF
1020	\$T	DC4
1021	\$U	NAK
1022	\$V	SYN
1023	\$W	ETB
1024	\$X	CAN
1025	\$Y	EM
1026	\$Z	SUB

**Table 8-4** *Prefix/Suffix Values (Continued)*

<b>Prefix/Suffix Value</b>	<b>Full ASCII Code 39 Encode Character</b>	<b>ASCII Character</b>
1027	%A	ESC
1028	%B	FS
1029	%C	GS
1030	%D	RS
1031	%E	US
1032	Space	Space
1033	/A	!
1034	/B	"
1035	/C	#
1036	/D	\$
1037	/E	%
1038	/F	&
1039	/G	'
1040	/H	(
1041	/I	)
1042	/J	*
1043	/K	+
1044	/L	,
1045	-	-
1046	.	.
1047	/O	/
1048	0	0
1049	1	1
1050	2	2
1051	3	3
1052	4	4
1053	5	5
1054	6	6
1055	7	7
1056	8	8

**Table 8-4** *Prefix/Suffix Values (Continued)*

<b>Prefix/Suffix Value</b>	<b>Full ASCII Code 39 Encode Character</b>	<b>ASCII Character</b>
1057	9	9
1058	/Z	:
1059	%F	;
1060	%G	<
1061	%H	=
1062	%I	>
1063	%J	?
1064	%V	@
1065	A	A
1066	B	B
1067	C	C
1068	D	D
1069	E	E
1070	F	F
1071	G	G
1072	H	H
1073	I	I
1074	J	J
1075	K	K
1076	L	L
1077	M	M
1078	N	N
1079	O	O
1080	P	P
1081	Q	Q
1082	R	R
1083	S	S
1084	T	T
1085	U	U
1086	V	V

**Table 8-4** *Prefix/Suffix Values (Continued)*

<b>Prefix/Suffix Value</b>	<b>Full ASCII Code 39 Encode Character</b>	<b>ASCII Character</b>
1087	W	W
1088	X	X
1089	Y	Y
1090	Z	Z
1091	%K	[
1092	%L	\
1093	%M	]
1094	%N	^
1095	%O	_
1096	%W	`
1097	+A	a
1098	+B	b
1099	+C	c
1100	+D	d
1101	+E	e
1102	+F	f
1103	+G	g
1104	+H	h
1105	+I	i
1106	+J	j
1107	+K	k
1108	+L	l
1109	+M	m
1110	+N	n
1111	+O	o
1112	+P	p
1113	+Q	q
1114	+R	r
1115	+S	s
1116	+T	t

**Table 8-4** *Prefix/Suffix Values (Continued)*

<b>Prefix/Suffix Value</b>	<b>Full ASCII Code 39 Encode Character</b>	<b>ASCII Character</b>
1117	+U	u
1118	+V	v
1119	+W	w
1120	+X	x
1121	+Y	y
1122	+Z	z
1123	%P	{
1124	%Q	
1125	%R	}
1126	%S	~
1127		Undefined
7013		ENTER



# Chapter 9 USB Interface

---

## Introduction

This chapter describes how to set up the device with a USB host. The device connects directly to a USB host, or a powered USB hub, which powers it. No additional power supply is required.

Throughout the programming bar code menus, asterisks (\*) indicate default values.



\*Indicates Default — \*North American Standard USB Keyboard — Feature/Option

- ✓ **NOTE** Most computer monitors allow scanning the bar codes directly on the screen. When scanning from the screen, be sure to set the document magnification to a level where you can see the bar code clearly, and bars and/or spaces are not merging.

## Connecting a USB Interface

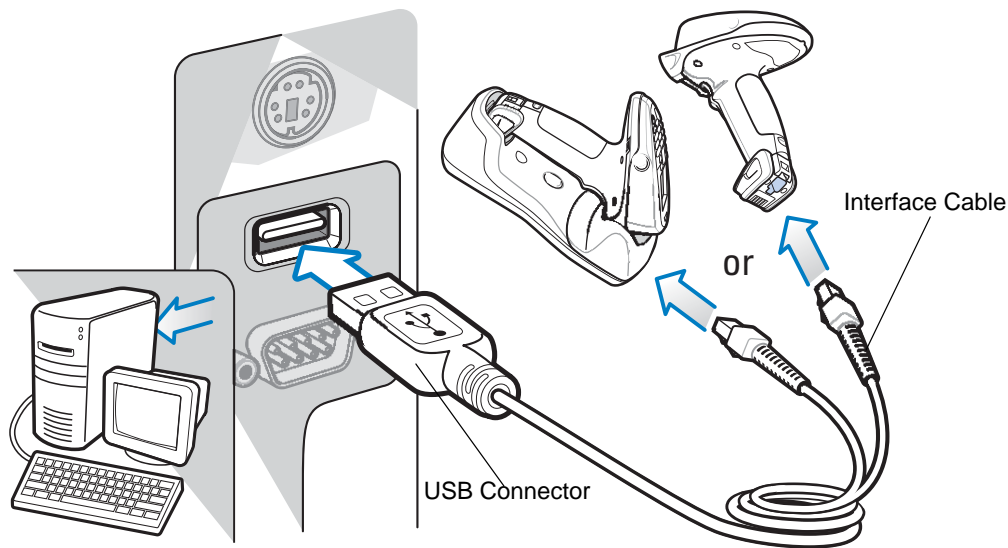

**Figure 9-1** USB Connection



**NOTES** 1. Connect a power supply to the cradle (not shown) for fast charging.

2. When connecting the host cable directly to the device, the host cable should not be attached to or detached from the device more than once a day (to prevent excessive contact wear).

3. If connecting ActiveSync via USB, it is recommended you use an ESD dongle with the USB cable. (ESD part numbers KT-8830-03R -3 piece kit, or KT-8830-10R - 10 piece kit.)

The device connects with USB-capable hosts including:

- Desktop PCs and notebooks
  - Apple™ iMac, G4, iBooks (North America only)
  - IBM SurePOS terminals
- Sun, IBM, and other network computers that support more than one keyboard.

The following operating systems support the device through USB:

- Windows® 98, 2000, ME, XP
- MacOS 8.5 - MacOS 10.3
- IBM 4690 OS.

The device also interfaces with other USB hosts which support USB Human Interface Devices (HID).



To set up the device:

✓ **NOTE** Interface cables vary depending on configuration. The connectors illustrated in [Figure 9-1](#) are examples only. The connectors may be different than those illustrated, but the steps to connect the device are the same.

1. Connect the modular connector of the USB interface cable to the host interface port on the cradle or device.
2. Plug the series A connector in the USB host or hub, or plug the Plus Power connector in an available port of the IBM SurePOS terminal.
3. Select the USB device type by scanning the appropriate bar code from [USB Device Type on page 9-5](#).
4. On first installation when using Windows, the software prompts to select or install the Human Interface Device driver. To install this driver, provided by Windows, click **Next** through all the choices and click **Finished** on the last choice. The device powers up during this installation.
5. To modify any other parameter options, scan the appropriate bar codes in this chapter.

If problems occur with the system, see [Troubleshooting on page 15-3](#).

## USB Parameter Defaults

[Table 9-1](#) lists the defaults for USB host parameters. To change any option, scan the appropriate bar code(s) provided in the *Parameter Descriptions* section beginning on page [9-3](#).

✓ **NOTE** See [Appendix A, Standard Default Parameters](#) for all user preferences, hosts, symbologies, and miscellaneous default parameters.

**Table 9-1** *USB Interface Parameter Defaults*

Parameter	Default	Page Number
<b>USB Host Parameters</b>		
USB Device Type	HID Keyboard Emulation	<a href="#">9-5</a>
CDC COM Port Emulation	Enable	<a href="#">9-7</a>
Symbol Native API (SNAPI) Status Handshaking	Enable	<a href="#">9-7</a>
USB Country Keyboard Types (Country Codes)	North American	<a href="#">9-8</a>
USB Keystroke Delay	No Delay	<a href="#">9-10</a>
USB CAPS Lock Override	Disable	<a href="#">9-10</a>
USB Ignore Unknown Characters	Enable	<a href="#">9-11</a>
USB Ignore Beep Directive	Honor	<a href="#">9-11</a>
USB Ignore Type Directive	Honor	<a href="#">9-12</a>
Emulate Keypad	Disable	<a href="#">9-12</a>
Emulate Keypad with Leading Zero	Disable	<a href="#">9-13</a>

**Table 9-1** *USB Interface Parameter Defaults (Continued)*

<b>Parameter</b>	<b>Default</b>	<b>Page Number</b>
USB FN1 Substitution	Disable	<a href="#">9-13</a>
Function Key Mapping	Disable	<a href="#">9-14</a>
Simulated Caps Lock	Disable	<a href="#">9-14</a>
Convert Case	None	<a href="#">9-15</a>
<b>USB Transmission Speed Parameters</b>		
USB Polling Interval	8 msec	<a href="#">9-16</a>
Fast HID Keyboard	Disable	<a href="#">9-18</a>
Quick Keypad Emulation	Disable	<a href="#">9-18</a>
USB HID Over the STB2000 Charge-only Cradle	Disable	<a href="#">9-19</a>

---

## USB Host Parameters

### USB Device Type



**IMPORTANT** The SNAPi interface connection is supported only by a cable connection between the device and host.

Select the desired USB device type.



**NOTE** When changing USB Device Types, the device automatically resets and issues the standard startup beep sequences.

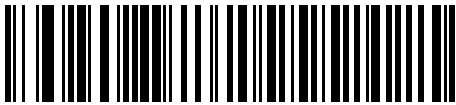

\*HID Keyboard Emulation



IBM Table Top USB

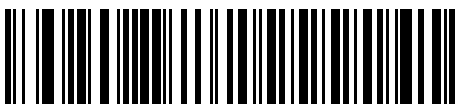

IBM Hand-Held USB



USB CDC Host



USB OPOS Handheld

## USB Device Type (continued)



Simple COM Port Emulation



Symbol Native API (SNAPI) with Imaging Interface



Symbol Native API (SNAPI) without Imaging Interface

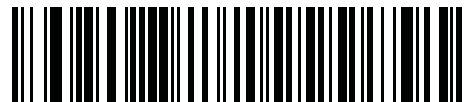

ActiveSync Host

## CDC COM Port Emulation

When enabled, the device reports a generic (non-unique) GUID in place of its unique GUID. This allows a single COM port to be allocated for multiple devices, although only a single such device should be connected at any given time. When disabled, the unique GUID reports to the host machine and a COM port is allocated for that particular device.

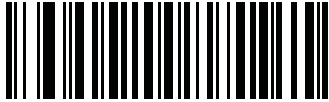

\* Enable Static CDC

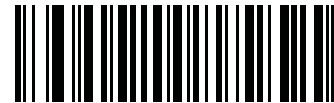

Disable Static CDC

## Symbol Native API (SNAPI) Status Handshaking

After selecting a SNAPI interface as the USB device type, select whether to enable or disable status handshaking.



\* Enable SNAPI Status Handshaking



Disable SNAPI Status Handshaking

## USB Country Keyboard Types - Country Codes

Scan the bar code corresponding to the keyboard type. This setting applies only to the USB HID Keyboard Emulation device.



\*North American Standard USB Keyboard

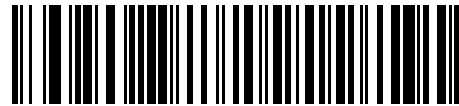

German Windows

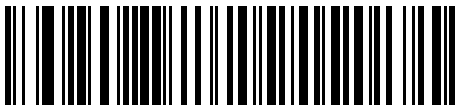

French Windows

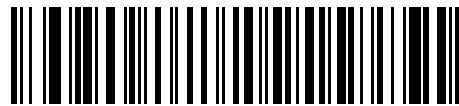

French Belgian Windows

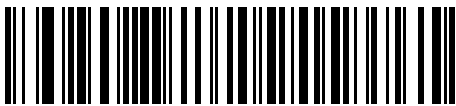

French Canadian Windows 95/98



French Canadian Windows 2000/XP

## USB Country Keyboard Types - Country Codes (continued)



Spanish Windows

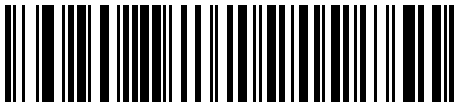

Italian Windows



Swedish Windows

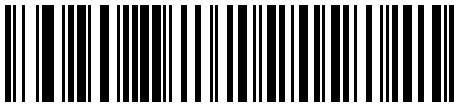

UK English Windows



Japanese Windows (ASCII)

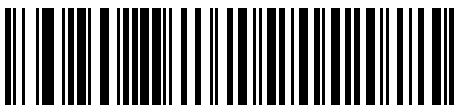

Portuguese-Brazilian Windows

## USB Keystroke Delay

This parameter sets the delay, in milliseconds, between emulated keystrokes. Scan a bar code below to increase the delay when hosts require a slower transmission of data.

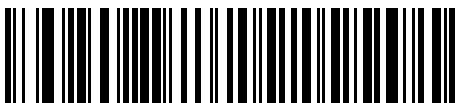

\*No Delay



Medium Delay (20 msec)

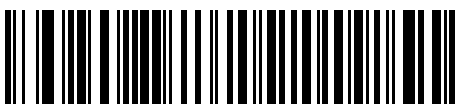

Long Delay (40 msec)

## USB CAPS Lock Override

This option applies only to the HID Keyboard Emulation device. Enable this to preserve the case of the data regardless of the state of the **Caps Lock** key. This setting is always enabled for the Japanese, Windows (ASCII) keyboard type and can not be disabled.



Override Caps Lock Key  
(Enable)



\*Do Not Override Caps Lock Key  
(Disable)



## USB Ignore Unknown Characters

This option applies only to the HID Keyboard Emulation device and IBM device. Unknown characters are characters the host does not recognize. Select **Send Bar Codes With Unknown Characters** to send all bar code data except for unknown characters. The device issues no error beeps.

Select **Do Not Send Bar Codes With Unknown Characters**, for IBM devices, to prevent sending bar codes containing at least one unknown character to the host, or for HID Keyboard Emulation devices, this sends the bar code characters up to the unknown character. The device issues an error beep.

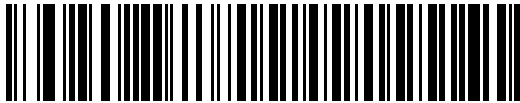

**\* Send Bar Codes with Unknown Characters  
(Transmit)**

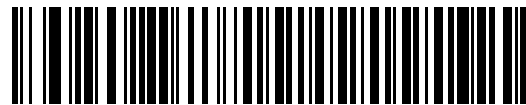

**Do Not Send Bar Codes with Unknown Characters  
(Disable)**

## USB Ignore Beep Directive

This applies only to IBM handheld, IBM tabletop, and OPOS devices. Scan one of the following bar codes to honor or ignore a beep directive. All directives are still acknowledged as if they were processed.



**\* Honor USB Beep Directive**



**Ignore USB Beep Directive**

## USB Ignore Type Directive

This applies only to IBM handheld, IBM tabletop, and OPOS devices. Scan one of the following bar codes to honor or ignore a code type enable/disable directive. All directives are still acknowledged as if they were processed.

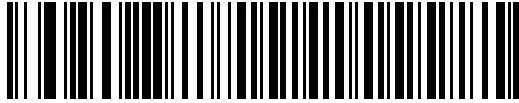

\* Honor USB Ignore Type Directive



Ignore USB Ignore Type Directive

## Emulate Keypad

Enable this to send all characters as ASCII sequences over the numeric keypad. For example ASCII A transmits as "ALT make" 0 6 5 "ALT Break".



\* Disable Keypad Emulation



Enable Keypad Emulation

## Emulate Keypad with Leading Zero

Enable this to send character sequences sent over the numeric keypad as ISO characters which have a leading zero. For example ASCII A transmits as "ALT MAKE" 0 0 6 5 "ALT BREAK".



\*Disable Keypad Emulation with Leading Zero



Enable Keypad Emulation with Leading Zero

## USB Keyboard FN 1 Substitution

This option applies only to the USB HID Keyboard Emulation device. Enable this to replace any FN 1 characters in an EAN 128 bar code with a user-selected Key Category and value (see [FN1 Substitution Values on page 5-26](#) to set the Key Category and Key Value).



Enable

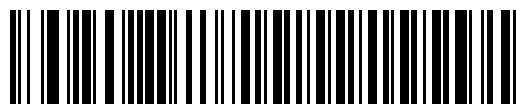

\*Disable

## Function Key Mapping

ASCII values under 32 are normally sent as a control-key sequences (see [Table 9-2 on page 9-20](#)). Enable this parameter to send the keys in bold in place of the standard key mapping. Table entries that do not have a bold entry remain the same whether or not you enable this parameter.



\*Disable Function Key Mapping

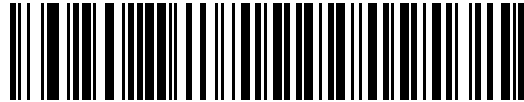

Enable Function Key Mapping

## Simulated Caps Lock

Enable this to invert upper and lower case characters on the bar code as if the Caps Lock state is enabled on the keyboard. This inversion occurs regardless of the keyboard's **Caps Lock** state.

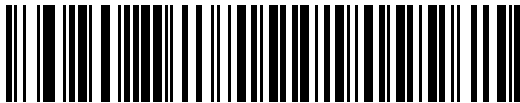

\*Disable Simulated Caps Lock

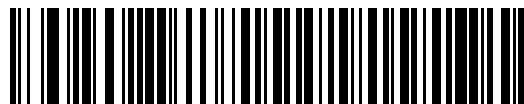

Enable Simulated Caps Lock

## Convert Case

Enable this to convert all bar code data to the selected case.



\*No Case Conversion



Convert All to Upper Case

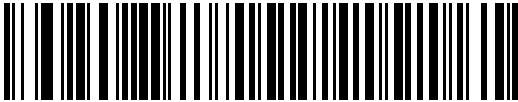

Convert All to Lower Case

## USB Transmission Speed Parameters

Use the following parameters to speed USB data transmission:

- *USB Polling Interval* - When using more current USB systems, use this parameter to set a lower interval in order to increase data transmission speed.
- *Fast HID Keyboard* - When configured as a USB HID keyboard device, use this parameter to increase the data transmission speed of printable (7-bit) ASCII characters.
- *Quick Keypad Emulation* - When configured as a USB HID keyboard device, use this parameter to increase the data transmission speed of a mix of both printable (7-bit) and full (8-bit) ASCII characters.

✓ **NOTE** Emulate Keypad and Quick Emulation override Fast HID

### USB Polling Interval

This option speeds data transmission for all USB devices except CDC. Scan a bar code below to set the polling interval. The polling interval determines the rate at which data can be sent between the scanner and the host computer. A lower number indicates a faster data rate. The default value is 8 msec.



**IMPORTANT** Changing the polling interval re-enumerates the scanner. In corded operation, the user must wait up to 10 seconds (depending on the system) prior to resuming scanning bar codes. If the user continues scanning without waiting the required time period data may be lost.



**CAUTION** Ensure your host machine can handle the selected data rate. Selecting a data rate that is too fast for the host can result in lost data.

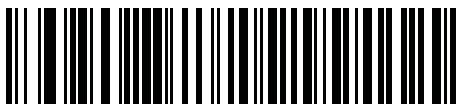

1 msec

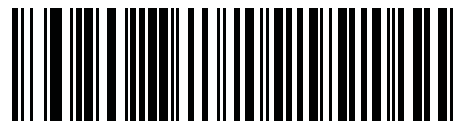

2 msec

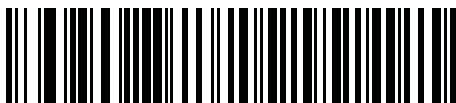

3 msec



4 msec

**USB Polling Interval (continued)**



**5 msec**

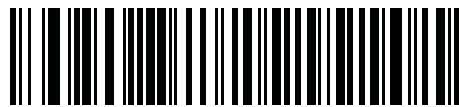

**6 msec**

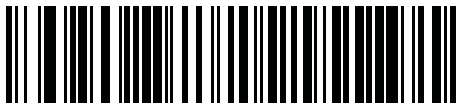

**7 msec**

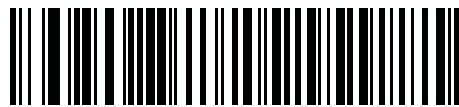

**\* 8 msec**

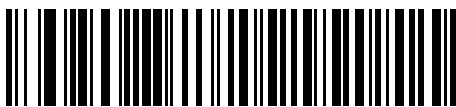

**9 msec**

### Fast HID Keyboard

This option transmits USB HID keyboard data at a faster rate.

✓ **NOTE** Quick Emulation overrides Fast HID.

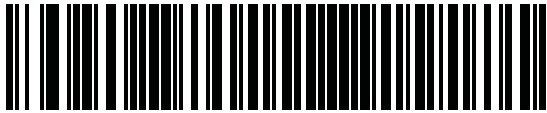

Enable

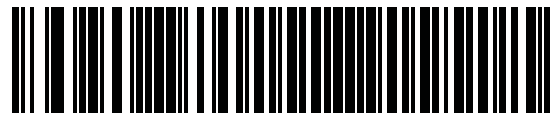

\* Disable

### Quick Keypad Emulation

This option applies only to the HID Keyboard Emulation Device and if Emulate Keypad is enabled. This parameter enables a quicker method of keypad emulation where ASCII sequences are only sent for ASCII characters not found on the keyboard. The default value is **Disable**.

This option applies only to the HID keyboard emulation device when [Emulate Keypad on page 9-12](#) is enabled. This parameter enables a quicker method of emulation utilizing the numeric keypad. The default value is **Disable**.

✓ **NOTE** This feature is not compatible with **Fast HID Keyboard** mode.

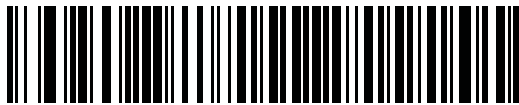

Enable



\* Disable



## USB HID Over the STB2000 Charge-only Cradle

This parameter allows HID keyboard mode over the STB2000 charge-only cradle.

Scan [\\*HID Keyboard Emulation on page 9-5](#) (default), then scan **Enable USB HID Over STB2000 Contact** below. When the scanner is inserted into the STB2000 cradle, and the USB cable is connected to the PC, the cradle is enumerated as HID keyboard.



**Enable USB HID Over STB2000 Contact**



**\* Disable USB HID Over STB2000 Contact**

## ASCII Character Set for USB

**Table 9-2** USB Prefix/Suffix Values

Prefix/ Suffix Value	Full ASCII Code 39 Encode Character	Keystroke
1000	%U	CTRL 2
1001	\$A	CTRL A
1002	\$B	CTRL B
1003	\$C	CTRL C
1004	\$D	CTRL D
1005	\$E	CTRL E
1006	\$F	CTRL F
1007	\$G	CTRL G
1008	\$H	CTRL H/ <b>BACKSPACE</b> <sup>1</sup>
1009	\$I	CTRL I/ <b>HORIZONTAL TAB</b> <sup>1</sup>
1010	\$J	CTRL J
1011	\$K	CTRL K
1012	\$L	CTRL L
1013	\$M	CTRL M/ <b>ENTER</b> <sup>1</sup>
1014	\$N	CTRL N
1015	\$O	CTRL O
1016	\$P	CTRL P
1017	\$Q	CTRL Q
1018	\$R	CTRL R
1019	\$S	CTRL S
1020	\$T	CTRL T
1021	\$U	CTRL U
1022	\$V	CTRL V
1023	\$W	CTRL W
1024	\$X	CTRL X

<sup>1</sup>The keystroke in bold transmits only if you enable *Function Key Mapping* on page 9-14. Otherwise, the unbolded keystroke transmits.

**Table 9-2** USB Prefix/Suffix Values (Continued)

Prefix/ Suffix Value	Full ASCII Code 39 Encode Character	Keystroke
1025	\$Y	CTRL Y
1026	\$Z	CTRL Z
1027	%A	CTRL <b>[/ESC</b> <sup>1</sup>
1028	%B	CTRL \
1029	%C	CTRL ]
1030	%D	CTRL 6
1031	%E	CTRL -
1032	Space	Space
1033	/A	!
1034	/B	"
1035	/C	#
1036	/D	\$
1037	/E	%
1038	/F	&
1039	/G	'
1040	/H	(
1041	/I	)
1042	/J	*
1043	/K	+
1044	/L	,
1045	-	-
1046	.	.
1047	/O	/
1048	0	0
1049	1	1
1050	2	2
1051	3	3
1052	4	4

<sup>1</sup>The keystroke in bold transmits only if you enable *Function Key Mapping* on page 9-14. Otherwise, the unbolded keystroke transmits.

**Table 9-2** USB Prefix/Suffix Values (Continued)

Prefix/ Suffix Value	Full ASCII Code 39 Encode Character	Keystroke
1053	5	5
1054	6	6
1055	7	7
1056	8	8
1057	9	9
1058	/Z	:
1059	%F	;
1060	%G	<
1061	%H	=
1062	%I	>
1063	%J	?
1064	%V	@
1065	A	A
1066	B	B
1067	C	C
1068	D	D
1069	E	E
1070	F	F
1071	G	G
1072	H	H
1073	I	I
1074	J	J
1075	K	K
1076	L	L
1077	M	M
1078	N	N
1079	O	O
1080	P	P

<sup>1</sup>The keystroke in bold transmits only if you enable *Function Key Mapping on page 9-14*. Otherwise, the unbolded keystroke transmits.

**Table 9-2** USB Prefix/Suffix Values (Continued)

Prefix/ Suffix Value	Full ASCII Code 39 Encode Character	Keystroke
1081	Q	Q
1082	R	R
1083	S	S
1084	T	T
1085	U	U
1086	V	V
1087	W	W
1088	X	X
1089	Y	Y
1090	Z	Z
1091	%K	[
1092	%L	\
1093	%M	]
1094	%N	^
1095	%O	_
1096	%W	`
1097	+A	<b>a</b>
1098	+B	<b>b</b>
1099	+C	<b>c</b>
1100	+D	<b>d</b>
1101	+E	<b>e</b>
1102	+F	<b>f</b>
1103	+G	<b>g</b>
1104	+H	<b>h</b>
1105	+I	<b>i</b>
1106	+J	<b>j</b>
1107	+K	<b>k</b>
1108	+L	<b>l</b>

<sup>1</sup>The keystroke in bold transmits only if you enable *Function Key Mapping* on page 9-14. Otherwise, the unbolded keystroke transmits.

**Table 9-2** USB Prefix/Suffix Values (Continued)

Prefix/ Suffix Value	Full ASCII Code 39 Encode Character	Keystroke
1109	+M	m
1110	+N	n
1111	+O	o
1112	+P	p
1113	+Q	q
1114	+R	r
1115	+S	s
1116	+T	t
1117	+U	u
1118	+V	v
1119	+W	w
1120	+X	x
1121	+Y	y
1122	+Z	z
1123	%P	{
1124	%Q	
1125	%R	}
1126	%S	~

<sup>1</sup>The keystroke in bold transmits only if you enable *Function Key Mapping* on page 9-14. Otherwise, the unbolded keystroke transmits.

**Table 9-3** USB ALT Key Character Set

ALT Keys	Keystroke
2064	ALT 2
2065	ALT A
2066	ALT B
2067	ALT C
2068	ALT D
2069	ALT E
2070	ALT F
2071	ALT G
2072	ALT H
2073	ALT I
2074	ALT J
2075	ALT K
2076	ALT L
2077	ALT M
2078	ALT N
2079	ALT O
2080	ALT P
2081	ALT Q
2082	ALT R
2083	ALT S
2084	ALT T
2085	ALT U
2086	ALT V
2087	ALT W
2088	ALT X
2089	ALT Y
2090	ALT Z

**Table 9-4** USB GUI Key Character Set

GUI Key	Keystroke
3000	Right Control Key
3048	GUI 0
3049	GUI 1
3050	GUI 2
3051	GUI 3
3052	GUI 4
3053	GUI 5
3054	GUI 6
3055	GUI 7
3056	GUI 8
3057	GUI 9
3065	GUI A
3066	GUI B
3067	GUI C
3068	GUI D
3069	GUI E
3070	GUI F
3071	GUI G
3072	GUI H
3073	GUI I
3074	GUI J
3075	GUI K
3076	GUI L
3077	GUI M
3078	GUI N
3079	GUI O
3080	GUI P

**Note: GUI Shift Keys - The Apple™ iMac keyboard has an apple key on either side of the space bar. Windows-based systems have a GUI key to the left of the left ALT key, and to the right of the right ALT key.**



**Table 9-4** USB GUI Key Character Set (Continued)

GUI Key	Keystroke
3081	GUI Q
3082	GUI R
3083	GUI S
3084	GUI T
3085	GUI U
3086	GUI V
3087	GUI W
3088	GUI X
3089	GUI Y
3090	GUI Z

**Note: GUI Shift Keys - The Apple™ iMac keyboard has an apple key on either side of the space bar. Windows-based systems have a GUI key to the left of the left ALT key, and to the right of the right ALT key.**

**Table 9-5** *USB F Key Character Set*

<b>F Keys</b>	<b>Keystroke</b>
5001	F1
5002	F2
5003	F3
5004	F4
5005	F5
5006	F6
5007	F7
5008	F8
5009	F9
5010	F10
5011	F11
5012	F12
5013	F13
5014	F14
5015	F15
5016	F16
5017	F17
5018	F18
5019	F19
5020	F20
5021	F21
5022	F22
5023	F23
5024	F24

**Table 9-6** *USB Numeric Keypad Character Set*

<b>Numeric Keypad</b>	<b>Keystroke</b>
6042	*
6043	+
6044	undefined
6045	-
6046	.
6047	/
6048	0
6049	1
6050	2
6051	3
6052	4
6053	5
6054	6
6055	7
6056	8
6057	9
6058	Enter
6059	Num Lock

**Table 9-7** *USB Extended Keypad Character Set*

<b>Extended Keypad</b>	<b>Keystroke</b>
7001	Break
7002	Delete
7003	PgUp
7004	End
7005	Pg Dn
7006	Pause
7007	Scroll Lock
7008	Backspace
7009	Tab
7010	Print Screen
7011	Insert
7012	Home
7013	Enter
7014	Escape
7015	Up Arrow
7016	Down Arrow
7017	Left Arrow
7018	Right Arrow

# Chapter 10 IBM 468X / 469X Interface

---

## Introduction

This chapter describes how to set up the device with an IBM 468X/469X host.

Throughout the programming bar code menus, asterisks (\*) indicate default values.



\* Indicates Default — \*Disable Convert to Code 39 — Feature/Option

- ✓ **NOTE** Most computer monitors allow scanning the bar codes directly on the screen. When scanning from the screen, be sure to set the document magnification to a level where you can see the bar code clearly, and bars and/or spaces are not merging.

## Connecting to an IBM 468X/469X Host

Connect the device directly to the host interface.

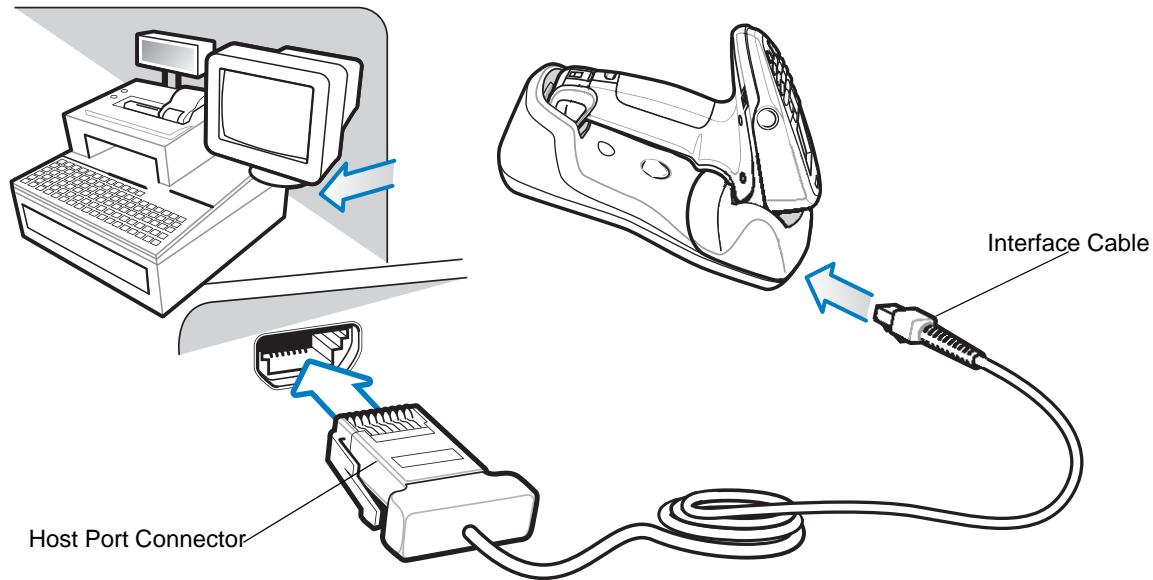

**Figure 10-1** IBM Direct Connection

- ✓ **NOTE** Connect a power supply to the cradle (not shown) for fast charging.
  - ✓ **NOTE** Interface cables vary depending on configuration. The connectors illustrated in [Figure 10-1](#) are examples only. The connectors may be different than those illustrated, but the steps to connect the device are the same.
1. Attach the modular connector of the IBM 46XX interface cable to the cable interface port on the device.
  2. Connect the other end of the IBM 46XX interface cable to the appropriate port on the host (typically Port 9).
  3. Select the port address by scanning the appropriate bar code from [Port Address on page 10-4](#).
  4. To modify any other parameter options, scan the appropriate bar codes in this chapter.
- ✓ **NOTE** The only required configuration is the port address. The IBM system typically controls other device parameters.

## IBM Parameter Defaults

[Table 10-1](#) lists the defaults for IBM host parameters. To change any option, scan the appropriate bar code(s) provided in the Parameter Descriptions section beginning on page [10-4](#).



**NOTE** See [Appendix A, Standard Default Parameters](#) for all user preferences, hosts, symbologies, and miscellaneous default parameters.

**Table 10-1** *IBM Host Default Table*

Parameter	Default	Page Number
<b>IBM 468X/469X Host Parameters</b>		
Port Address	None Selected	<a href="#">10-4</a>
Convert Unknown to Code 39	Disable	<a href="#">10-5</a>

---

## IBM 468X/469X Host Parameters

### Port Address

This parameter sets the IBM 468X/469X port used.

✓ **NOTE** Scanning one of these bar codes enables the RS-485 interface on the device.

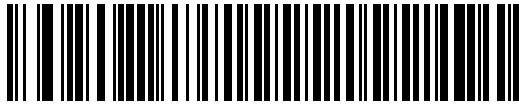

None Selected

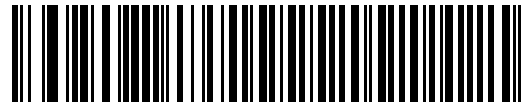

Hand-Held Scanner Emulation (Port 9B)

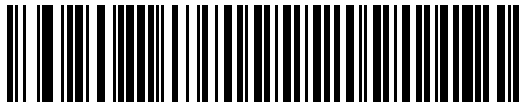

Non-IBM Scanner Emulation (Port 5B)

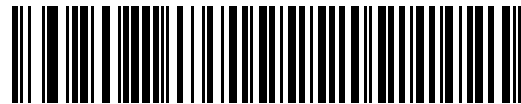
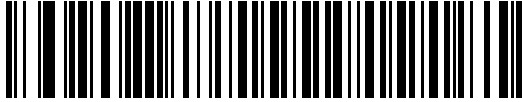

Table Top Scanner Emulation (Port 17)



## Convert Unknown to Code 39

Scan a bar code below to enable or disable the conversion of unknown bar code type data to Code 39.



**Enable Convert Unknown to Code 39**

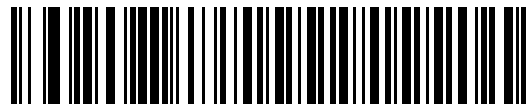

**\*Disable Convert Unknown to Code 39**



# Chapter 11 Keyboard Wedge Interface

---

## Introduction

This chapter describes how to set up a Keyboard Wedge interface with the device/cradle. With this interface, the cradle is connected between the keyboard and host computer, and translates scanned bar code data into keystrokes. The host computer accepts the keystrokes as if they originated from the keyboard. This mode adds bar code reading functionality to a system designed for manual keyboard input. Keyboard keystrokes are simply passed through.

Throughout the programming bar code menus, asterisks (\*) indicate default values.



\* Indicates Default — \*North American — Feature/Option

- ✓ **NOTE** Most computer monitors allow scanning the bar codes directly on the screen. When scanning from the screen, be sure to set the document magnification to a level where you can see the bar code clearly, and bars and/or spaces do not merge.

## Connecting a Keyboard Wedge Interface

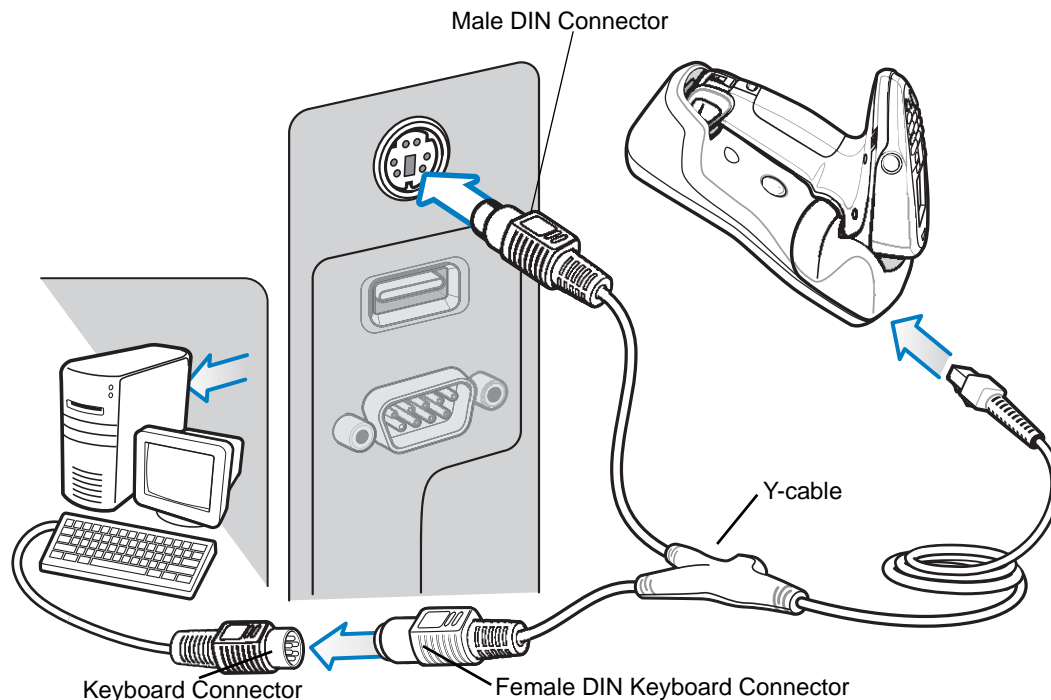

**Figure 11-1** Keyboard Wedge Connection with Y-cable

✓ **NOTE** Connect a power supply to the cradle (not shown) for fast charging.

To connect the Keyboard Wedge interface Y-cable:

✓ **NOTE** Interface cables vary depending on configuration. The connectors illustrated in [Figure 11-1](#) are examples only. The connectors may be different than those illustrated, but the steps to connect the device are the same.

1. Turn off the host and unplug the keyboard connector.
2. Attach the modular connector of the Y-cable to the cable interface port on the cradle.
3. Connect the round male DIN host connector of the Y-cable to the keyboard port on the host device.
4. Connect the round female DIN keyboard connector of the Y-cable to the keyboard connector.
5. If needed, attach the optional power supply to the connector in the middle of the Y-cable.
6. Ensure that all connections are secure.
7. Turn on the host system.
8. Select the Keyboard Wedge host type by scanning the appropriate bar code from [Keyboard Wedge Host Types on page 11-4](#).
9. To modify any other parameter options, scan the appropriate bar codes in this chapter.

## Keyboard Wedge Parameter Defaults

[Table 11-1](#) lists the defaults for Keyboard Wedge host parameters. To change any option, scan the appropriate bar code(s) in the Keyboard Wedge Host Parameters section beginning on page [11-4](#).

✓ **NOTE** See [Appendix A, Standard Default Parameters](#) for all user preferences, hosts, symbologies, and miscellaneous default parameters.

**Table 11-1** Keyboard Wedge Host Default Table

Parameter	Default	Page Number
<b>Keyboard Wedge Host Parameters</b>		
Keyboard Wedge Host Type	IBM PC/AT& IBM PC Compatibles	<a href="#">11-4</a>
Country Types (Country Codes)	North American	<a href="#">11-5</a>
Ignore Unknown Characters	Transmit	<a href="#">11-7</a>
Keystroke Delay	No Delay	<a href="#">11-7</a>
Intra-Keystroke Delay	Disable	<a href="#">11-8</a>
Alternate Numeric Keypad Emulation	Disable	<a href="#">11-8</a>
Caps Lock On	Disable	<a href="#">11-9</a>
Caps Lock Override	Disable	<a href="#">11-9</a>
Convert Wedge Data	No Convert	<a href="#">11-10</a>
Function Key Mapping	Disable	<a href="#">11-10</a>
FN1 Substitution	Disable	<a href="#">11-11</a>
Send and Make Break	Send	<a href="#">11-11</a>

---

## Keyboard Wedge Host Parameters

### Keyboard Wedge Host Types

Select the Keyboard Wedge host by scanning one of the bar codes below.

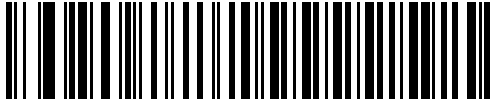

**IBM PC/AT & IBM PC Compatibles**

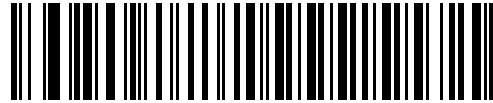

**IBM AT Notebook**

## Keyboard Wedge Country Types - Country Codes

Scan the bar code corresponding to the keyboard type. If your keyboard type does not appear, see [Alternate Numeric Keypad Emulation on page 11-8](#).



\*North American



German Windows

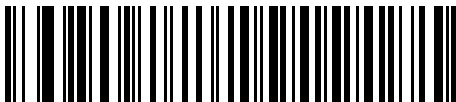

French Windows



French Canadian Windows 95/98

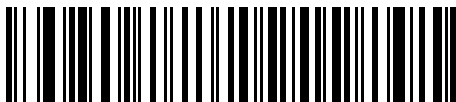

French Canadian Windows XP/2000



French Belgian Windows

## Keyboard Wedge Country Types - Country Codes (continued)



Spanish Windows

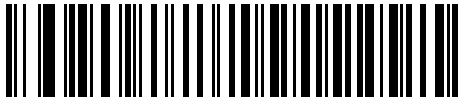

Italian Windows



Swedish Windows



UK English Windows



Japanese Windows

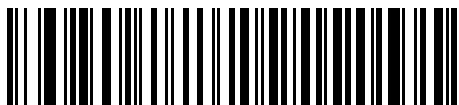

Portuguese-Brazilian Windows



## Ignore Unknown Characters

Unknown characters are characters the host does not recognize. Select **Send Bar Codes With Unknown Characters** to send all bar code data except for unknown characters. The device issues no error beeps.

Select **Do Not Send Bar Codes With Unknown Characters** to send bar code data up to the first unknown character. The device issues an error beep.



**\*Send Bar Codes with Unknown Characters  
(Transmit)**

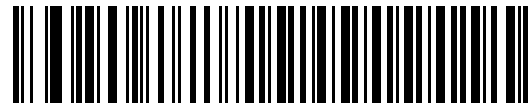

**Do Not Send Bar Codes with Unknown Characters**

## Keystroke Delay

This is the delay in milliseconds between emulated keystrokes. Scan a bar code below to increase the delay when hosts require a slower transmission of data.

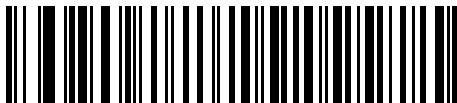

**\*No Delay**



**Medium Delay (20 msec)**

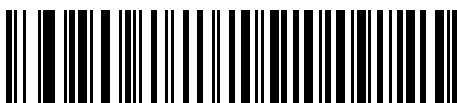

**Long Delay (40 msec)**

## Intra-Keystroke Delay

Enable this to insert an additional delay between each emulated key depression and release. This sets the Keystroke Delay parameter to a minimum of 5 msec as well.

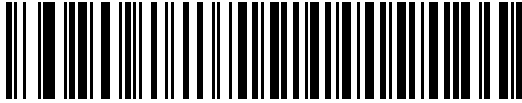

Enable

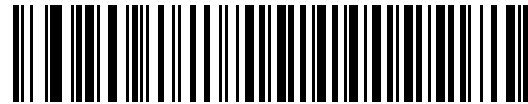

\*Disable

## Alternate Numeric Keypad Emulation

This allows emulation of most other country keyboard types not listed in [Keyboard Wedge Country Types - Country Codes on page 11-5](#) in a Microsoft® operating system environment.

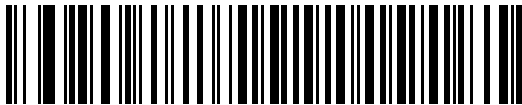

Enable Alternate Numeric Keypad

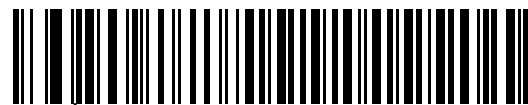

\*Disable Alternate Numeric Keypad

## Caps Lock On

Enable this to emulate keystrokes as if the **Caps Lock** key is always pressed.

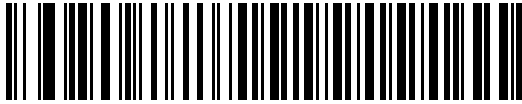

Enable Caps Lock On

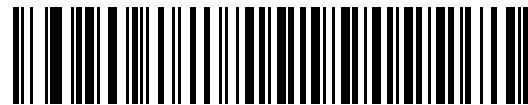

\*Disable Caps Lock On

## Caps Lock Override

If you enable this, on AT or AT Notebook hosts, the device ignores the state of the **Caps Lock** key. Therefore, an 'A' in the bar code transmits as an 'A' regardless of the state of the keyboard's **Caps Lock** key.

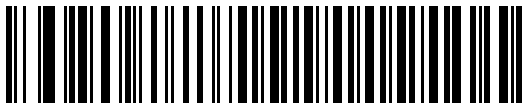

Enable Caps Lock Override



\*Disable Caps Lock Override



**NOTE** If both Caps Lock On and Caps Lock Override are enabled, Caps Lock Override takes precedence.

## Convert Wedge Data

Enable this to convert all bar code data to the selected case.



Convert to Upper Case

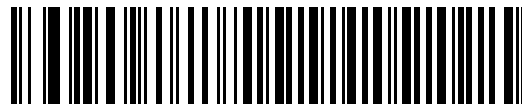

Convert to Lower Case



\*No Convert

## Function Key Mapping

ASCII values under 32 are normally sent as control key sequences (see [Table 11-2 on page 11-13](#)). Enable this parameter to send the keys in bold in place of the standard key mapping. Table entries that do not have a bold entry remain the same whether or not you enable this parameter.

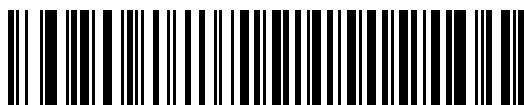

Enable



\*Disable

## FN1 Substitution

Enable this to replace FN1 characters in an EAN128 bar code with a user-selected keystroke (see [FN1 Substitution on page 11-11](#)).



**Enable**



**\*Disable**

## Send Make and Break

Enable this to prevent sending the scan codes for releasing a key.



**\*Send Make and Break Scan Codes**

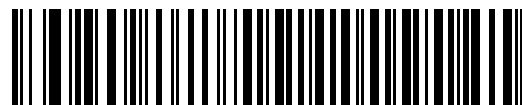

**Send Make Scan Code Only**

## Keyboard Maps

See the following keyboard maps for prefix/suffix keystroke parameters. To program the prefix/suffix values, see the bar codes on [page 5-24](#).

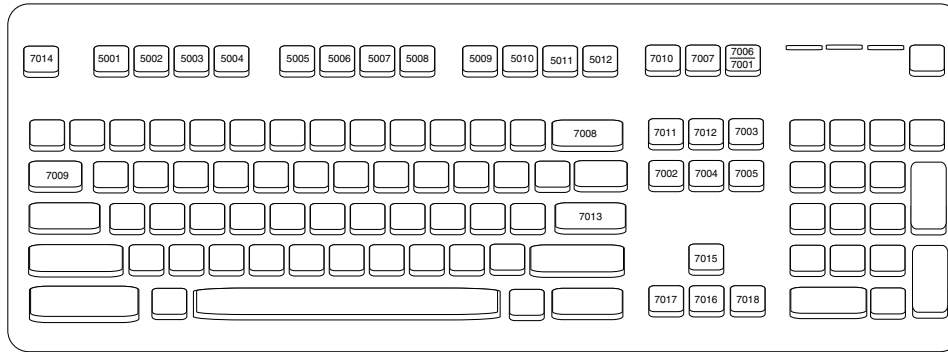

**Figure 11-2** IBM PS2 Type Keyboard

## ASCII Character Set for Keyboard Wedge

- ✓ **NOTE** Code 39 Full ASCII interprets the bar code special character (\$ + % /) preceding a Code 39 character and assigns an ASCII character value to the pair. For example, if you enable Code 39 Full ASCII and scan **+B**, it transmits as **b**, **%J** as **?**, and **%V** as **@**. Scanning **ABC%I** outputs the keystroke equivalent of **ABC >**.

**Table 11-2** Keyboard Wedge ASCII Character Set

ASCII Value	Full ASCII Code 39 Encode Character	Keystroke
1001	\$A	CTRL A
1002	\$B	CTRL B
1003	\$C	CTRL C
1004	\$D	CTRL D
1005	\$E	CTRL E
1006	\$F	CTRL F
1007	\$G	CTRL G
1008	\$H	CTRL H/ <b>BACKSPACE</b> <sup>1</sup>
1009	\$I	CTRL I/ <b>HORIZONTAL TAB</b> <sup>1</sup>
1010	\$J	CTRL J
1011	\$K	CTRL K
1012	\$L	CTRL L
1013	\$M	CTRL M/ <b>ENTER</b> <sup>1</sup>
1014	\$N	CTRL N
1015	\$O	CTRL O
1016	\$P	CTRL P
1017	\$Q	CTRL Q
1018	\$R	CTRL R
1019	\$S	CTRL S
1020	\$T	CTRL T
1021	\$U	CTRL U
1022	\$V	CTRL V
1023	\$W	CTRL W

<sup>1</sup>The keystroke in bold transmits only if you enabled *Function Key Mapping* on page 11-10. Otherwise, the unbolded keystroke transmits.

**Table 11-2** Keyboard Wedge ASCII Character Set (Continued)

ASCII Value	Full ASCII Code 39 Encode Character	Keystroke
1024	\$X	CTRL X
1025	\$Y	CTRL Y
1026	\$Z	CTRL Z
1027	%A	CTRL [ /ESC <sup>1</sup>
1028	%B	CTRL \
1029	%C	CTRL ]
1030	%D	CTRL 6
1031	%E	CTRL -
1032	Space	Space
1033	/A	!
1034	/B	"
1035	/C	#
1036	/D	\$
1037	/E	%
1038	/F	&
1039	/G	'
1040	/H	(
1041	/I	)
1042	/J	*
1043	/K	+
1044	/L	,
1045	-	-
1046	.	.
1047	/O	/
1048	0	0
1049	1	1
1050	2	2
1051	3	3

<sup>1</sup>The keystroke in bold transmits only if you enabled *Function Key Mapping* on page 11-10. Otherwise, the unbolded keystroke transmits.



**Table 11-2** Keyboard Wedge ASCII Character Set (Continued)

ASCII Value	Full ASCII Code 39 Encode Character	Keystroke
1052	4	4
1053	5	5
1054	6	6
1055	7	7
1056	8	8
1057	9	9
1058	/Z	:
1059	%F	;
1060	%G	<
1061	%H	=
1062	%I	>
1063	%J	?
1064	%V	@
1065	A	A
1066	B	B
1067	C	C
1068	D	D
1069	E	E
1070	F	F
1071	G	G
1072	H	H
1073	I	I
1074	J	J
1075	K	K
1076	L	L
1077	M	M
1078	N	N
1079	O	O

<sup>1</sup>The keystroke in bold transmits only if you enabled *Function Key Mapping* on page 11-10. Otherwise, the unbolded keystroke transmits.

**Table 11-2** Keyboard Wedge ASCII Character Set (Continued)

ASCII Value	Full ASCII Code 39 Encode Character	Keystroke
1080	P	P
1081	Q	Q
1082	R	R
1083	S	S
1084	T	T
1085	U	U
1086	V	V
1087	W	W
1088	X	X
1089	Y	Y
1090	Z	Z
1091	%K	[
1092	%L	\
1093	%M	]
1094	%N	^
1095	%O	_
1096	%W	'
1097	+A	<b>a</b>
1098	+B	<b>b</b>
1099	+C	<b>c</b>
1100	+D	<b>d</b>
1101	+E	<b>e</b>
1102	+F	<b>f</b>
1103	+G	<b>g</b>
1104	+H	<b>h</b>
1105	+I	<b>i</b>
1106	+J	<b>j</b>
1107	+K	<b>k</b>

<sup>1</sup>The keystroke in bold transmits only if you enabled *Function Key Mapping* on page 11-10. Otherwise, the unbolded keystroke transmits.

**Table 11-2** Keyboard Wedge ASCII Character Set (Continued)

ASCII Value	Full ASCII Code 39 Encode Character	Keystroke
1108	+L	l
1109	+M	m
1110	+N	n
1111	+O	o
1112	+P	p
1113	+Q	q
1114	+R	r
1115	+S	s
1116	+T	t
1117	+U	u
1118	+V	v
1119	+W	w
1120	+X	x
1121	+Y	y
1122	+Z	z
1123	%P	{
1124	%Q	
1125	%R	}
1126	%S	~

<sup>1</sup>The keystroke in bold transmits only if you enabled *Function Key Mapping* on page 11-10. Otherwise, the unbolded keystroke transmits.

**Table 11-3** Keyboard Wedge ALT Key Character Set

ALT Keys	Keystroke
2065	ALT A
2066	ALT B
2067	ALT C
2068	ALT D
2069	ALT E
2070	ALT F
2071	ALT G

**Table 11-3** Keyboard Wedge ALT Key Character Set (Continued)

ALT Keys	Keystroke
2072	ALT H
2073	ALT I
2074	ALT J
2075	ALT K
2076	ALT L
2077	ALT M
2078	ALT N
2079	ALT O
2080	ALT P
2081	ALT Q
2082	ALT R
2083	ALT S
2084	ALT T
2085	ALT U
2086	ALT V
2087	ALT W
2088	ALT X
2089	ALT Y
2090	ALT Z

**Table 11-4** Keyboard Wedge GUI Key Character Set

GUI Keys	Keystrokes
3000	Right Control Key
3048	GUI 0
3049	GUI 1
3050	GUI 2
3051	GUI 3
3052	GUI 4
3053	GUI 5
3054	GUI 6
3055	GUI 7

**Table 11-4** Keyboard Wedge GUI Key Character Set (Continued)

GUI Keys	Keystrokes
3056	GUI 8
3057	GUI 9
3065	GUI A
3066	GUI B
3067	GUI C
3068	GUI D
3069	GUI E
3070	GUI F
3071	GUI G
3072	GUI H
3073	GUI I
3074	GUI J
3075	GUI K
3076	GUI L
3077	GUI M
3078	GUI N
3079	GUI O
3080	GUI P
3081	GUI Q
3082	GUI R
3083	GUI S
3084	GUI T
3085	GUI U
3086	GUI V
3087	GUI W
3088	GUI X
3089	GUI Y
3090	GUI Z

**Table 11-5** Keyboard Wedge F Key Character Set

F Keys	Keystroke
5001	F1
5002	F2
5003	F3
5004	F4
5005	F5
5006	F6
5007	F7
5008	F8
5009	F9
5010	F10
5011	F11
5012	F12
5013	F13
5014	F14
5015	F15
5016	F16
5017	F17
5018	F18
5019	F19
5020	F20
5021	F21
5022	F22
5023	F23
5024	F24

**Table 11-6** Keyboard Wedge Numeric Keypad Character Set

Numeric Keypad	Keystroke
6042	*
6043	+
6044	undefined
6045	-

**Table 11-6** Keyboard Wedge Numeric Keypad Character Set (Continued)

Numeric Keypad	Keystroke
6046	.
6047	/
6048	0
6049	1
6050	2
6051	3
6052	4
6053	5
6054	6
6055	7
6056	8
6057	9
6058	Enter
6059	Num Lock

**Table 11-7** Keyboard Wedge Extended Keypad Character Set

Extended Keypad	Keystroke
7001	Break
7002	Delete
7003	Pg Up
7004	End
7005	Pg Dn
7006	Pause
7007	Scroll Lock
7008	Backspace
7009	Tab
7010	Print Screen
7011	Insert
7012	Home
7013	Enter
7014	Escape

**Table 11-7** *Keyboard Wedge Extended Keypad Character Set (Continued)*

Extended Keypad	Keystroke
7015	Up Arrow
7016	Dn Arrow
7017	Left Arrow
7018	Right Arrow



# Chapter 12 Symbologies

---

## Introduction

This chapter describes symbology features and provides programming bar codes for selecting these features. Before programming, follow the instructions in [Chapter 1, Getting Started](#).

To set feature values, scan a single bar code or a short bar code sequence. The settings are stored in non-volatile memory and are preserved even when the device powers down.

✓ **NOTE** Most computer monitors allow scanning the bar codes directly on the screen. When scanning from the screen, be sure to set the document magnification to a level where you can see the bar code clearly, and bars and/or spaces do not merge.

Select a host type (see each host chapter for specific host information) after the power-up beeps sound. This is only necessary upon the first power-up when connected to a new host.

To return all features to default values, scan the [Set Default Parameter on page 5-4](#). Throughout the programming bar code menus, asterisks (\*) indicate default values.

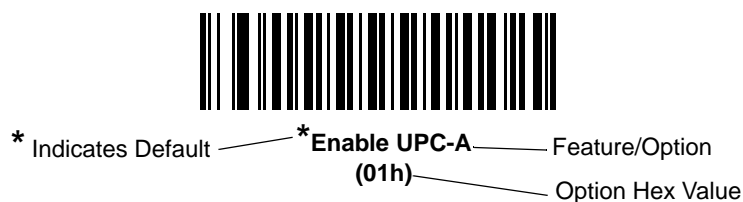

---

## Scanning Sequence Examples

In most cases, scanning one bar code sets the parameter value. For example, to transmit bar code data without the UPC-A check digit, simply scan the **Do Not Transmit UPC-A Check Digit** bar code under [Transmit UPC-A Check Digit on page 12-14](#). The device issues a fast warble beep and the LED turns green, signifying a successful parameter entry.

Other parameters, such as **Set Length(s) for D 2 of 5** require scanning several bar codes. See the individual parameter, such as **Set Length(s) for D 2 of 5**, for this procedure.

## Errors While Scanning

Unless otherwise specified, to correct an error during a scanning sequence, just re-scan the correct parameter.

## Symbology Parameter Defaults

[Table 12-1](#) lists the defaults for all symbologies parameters. Scan the appropriate bar codes in this guide. These new values replace the standard default values in memory. To recall the default parameter values, scan the [Set Default Parameter on page 5-4](#).

✓ **NOTE** See [Appendix A, Standard Default Parameters](#) for all user preferences, hosts, and miscellaneous default parameters.

**Table 12-1** *Parameter Defaults*

Parameter	Parameter Number	Default	Page Number
<b>UPC/EAN</b>			
UPC-A	01h	Enable	<a href="#">12-7</a>
UPC-E	02h	Enable	<a href="#">12-7</a>
UPC-E1	0Ch	Disable	<a href="#">12-8</a>
EAN-8/JAN 8	04h	Enable	<a href="#">12-8</a>
EAN-13/JAN 13	03h	Enable	<a href="#">12-9</a>
Bookland EAN	53h	Disable	<a href="#">12-9</a>
Decode UPC/EAN/JAN Supplementals (2 and 5 digits)	10h	Ignore	<a href="#">12-11</a>
User-Programmable Supplementals			<a href="#">12-13</a>
Supplemental 1:	F1h 43h		
Supplemental 2:	F1h 44h		
UPC/EAN/JAN Supplemental Redundancy	50h	10	<a href="#">12-13</a>
UPC/EAN/JAN Supplemental AIM ID Format	F1h A0h	Combined	<a href="#">12-14</a>
Transmit UPC-A Check Digit	28h	Enable	<a href="#">12-14</a>
Transmit UPC-E Check Digit	29h	Enable	<a href="#">12-14</a>
Transmit UPC-E1 Check Digit	2Ah	Enable	<a href="#">12-16</a>
UPC-A Preamble	22h	System Character	<a href="#">12-16</a>
UPC-E Preamble	23h	System Character	<a href="#">12-16</a>
UPC-E1 Preamble	24h	System Character	<a href="#">12-18</a>
Convert UPC-E to A	25h	Disable	<a href="#">12-19</a>

**Table 12-1** *Parameter Defaults (Continued)*

Parameter	Parameter Number	Default	Page Number
Convert UPC-E1 to A	26h	Disable	<a href="#">12-19</a>
EAN-8/JAN-8 Extend	27h	Disable	<a href="#">12-20</a>
Bookland ISBN Format	F1h 40h	ISBN-10	<a href="#">12-21</a>
UCC Coupon Extended Code	55h	Enable	<a href="#">12-22</a>
Coupon Report	F1h DAh	New Coupon Symbols	<a href="#">12-22</a>
ISSN EAN	F1h 69h	Disable	<a href="#">12-23</a>
<b>Code 128</b>			
Code 128	08h	Enable	<a href="#">12-24</a>
Set Length(s) for Code 128	D1h D2h	Any Length	<a href="#">12-24</a>
GS1-128 (formerly UCC/EAN-128)	0Eh	Enable	<a href="#">12-26</a>
ISBT 128	54h	Enable	<a href="#">12-26</a>
ISBT Concatenation	F1h 41h	Disable	<a href="#">12-27</a>
Check ISBT Table	F1h 42h	Enable	<a href="#">12-28</a>
<b>Code 39</b>			
Code 39	00h	Enable	<a href="#">12-29</a>
Trioptic Code 39	0Dh	Disable	<a href="#">12-29</a>
Convert Code 39 to Code 32 (Italian Pharmacy Code)	56h	Disable	<a href="#">12-30</a>
Code 32 Prefix	E7h	Disable	<a href="#">12-30</a>
Set Length(s) for Code 39	12h 13h	2 to 55	<a href="#">12-31</a>
Code 39 Check Digit Verification	30h	Disable	<a href="#">12-32</a>
Transmit Code 39 Check Digit	2Bh	Disable	<a href="#">12-32</a>
Code 39 Full ASCII Conversion	11h	Disable	<a href="#">12-33</a>
<b>Code 93</b>			
Code 93	09h	Disable	<a href="#">12-34</a>
Set Length(s) for Code 93	1Ah 1Bh	4 to 55	<a href="#">12-34</a>
<b>Code 11</b>			
Code 11	0Ah	Disable	<a href="#">12-36</a>
Set Lengths for Code 11	1Ch 1Dh	4 to 55	<a href="#">12-36</a>
Code 11 Check Digit Verification	34h	Disable	<a href="#">12-38</a>
Transmit Code 11 Check Digit(s)	2Fh	Disable	<a href="#">12-39</a>

**Table 12-1** Parameter Defaults (Continued)

Parameter	Parameter Number	Default	Page Number
<b>Interleaved 2 of 5 (ITF)</b>			
Interleaved 2 of 5 (ITF)	06h	Disable	<a href="#">12-39</a>
Set Lengths for I 2 of 5	16h 17h	14	<a href="#">12-40</a>
I 2 of 5 Check Digit Verification	31h	Disable	<a href="#">12-42</a>
Transmit I 2 of 5 Check Digit	2Ch	Disable	<a href="#">12-42</a>
Convert I 2 of 5 to EAN 13	52h	Disable	<a href="#">12-43</a>
<b>Discrete 2 of 5 (DTF)</b>			
Discrete 2 of 5	05h	Disable	<a href="#">12-43</a>
Set Length(s) for D 2 of 5	14h 15h	12	<a href="#">12-44</a>
<b>Codabar (NW - 7)</b>			
Codabar	07h	Disable	<a href="#">12-46</a>
Set Lengths for Codabar	18h 19h	5 to 55	<a href="#">12-46</a>
CLSI Editing	36h	Disable	<a href="#">12-48</a>
NOTIS Editing	37h	Disable	<a href="#">12-48</a>
Codabar Upper or Lower Case Start/Stop Characters Detection	F2h 57h	Upper Case	<a href="#">12-49</a>
<b>MSI</b>			
MSI	0Bh	Disable	<a href="#">12-50</a>
Set Length(s) for MSI	1Eh 1Fh	4 to 55	<a href="#">12-50</a>
MSI Check Digits	32h	One	<a href="#">12-52</a>
Transmit MSI Check Digit	2Eh	Disable	<a href="#">12-52</a>
MSI Check Digit Algorithm	33h	Mod 10/Mod 10	<a href="#">12-53</a>
<b>Matrix 2 of 5</b>			
Matrix 2 of 5	F1h 6Ah	Disable	<a href="#">12-54</a>
Matrix 2 of 5 Lengths	F1h 6Bh F1h 6Ch	One Length: 14	<a href="#">12-54</a>
Matrix 2 of 5 Check Digit	F1h 6Eh	Disable	<a href="#">12-56</a>
Transmit Matrix 2 of 5 Check Digit	F1h 6Fh	Disable	<a href="#">12-56</a>
<b>Chinese 2 of 5</b>			
Chinese 2 of 5	F0h 98h	Disable	<a href="#">12-57</a>

**Table 12-1** *Parameter Defaults (Continued)*

Parameter	Parameter Number	Default	Page Number
<b>Korean 3 of 5</b>			
Korean 3 of 5	F1h 45h	Disable	<a href="#">12-57</a>
<b>Inverse 1D</b>			
Inverse 1D	F1h 4Ah	Regular	<a href="#">12-58</a>
<b>Postal Codes</b>			
US Postnet	59h	Disable	<a href="#">12-59</a>
US Planet	5Ah	Disable	<a href="#">12-59</a>
Transmit US Postal Check Digit	5Fh	Enable	<a href="#">12-60</a>
UK Postal	5Bh	Disable	<a href="#">12-60</a>
Transmit UK Postal Check Digit	60h	Enable	<a href="#">12-61</a>
Japan Postal	F0h 22h	Disable	<a href="#">12-61</a>
Australian Postal	F0h 23h	Disable	<a href="#">12-62</a>
Australia Post Format	F1h CEh	Autodiscriminate	<a href="#">12-63</a>
Netherlands KIX Code	F0h 46h	Disable	<a href="#">12-64</a>
USPS 4CB/One Code/Intelligent Mail	F1h 50h	Disable	<a href="#">12-64</a>
UPU FICS Postal	F1h 63h	Disable	<a href="#">12-65</a>
<b>GS1 DataBar</b>			
GS1 DataBar-14	F0h 52h	Disable	<a href="#">12-66</a>
GS1 DataBar Limited	F0h 53h	Disable	<a href="#">12-66</a>
GS1 DataBar Expanded	F0h 54h	Disable	<a href="#">12-67</a>
Convert GS1 DataBar to UPC/EAN	F0h 8Dh	Disable	<a href="#">12-67</a>
GS1 DataBar Limited Security Level	F1h D8h	Security Level 3	<a href="#">12-68</a>
<b>Composite</b>			
Composite CC-C	F0h 55h	Disable	<a href="#">12-69</a>
Composite CC-A/B	F0h 56h	Disable	<a href="#">12-69</a>
Composite TLC-39	F0h 73h	Disable	<a href="#">12-70</a>
UPC Composite Mode	F0h 58h	Never Linked	<a href="#">12-70</a>
Composite Beep Mode	F0h 8Eh	Beep as Each Code Type is Decoded	<a href="#">12-71</a>
<b>2D Symbologies</b>			

**Table 12-1** *Parameter Defaults (Continued)*

Parameter	Parameter Number	Default	Page Number
PDF417	0Fh	Enable	<a href="#">12-71</a>
Micro PDF417	E3h	Disable	<a href="#">12-72</a>
Code 128 Emulation	7Bh	Disable	<a href="#">12-73</a>
Data Matrix	F0h 24h	Enable	<a href="#">12-74</a>
Maxicode	F0h 26h	Enable	<a href="#">12-74</a>
QR Code	F0h 25h	Enable	<a href="#">12-75</a>
MicroQR	F1h 3Dh	Enable	<a href="#">12-75</a>
Aztec	F1h 3Eh	Enable	<a href="#">12-76</a>
<b>Symbology-Specific Security Levels</b>			
Redundancy Level	4Eh	1	<a href="#">12-77</a>
Security Level	4Dh	0	<a href="#">12-79</a>
Report Version			<a href="#">12-80</a>

---

## UPC/EAN

### Enable/Disable UPC-A

#### Parameter # 01h

To enable or disable UPC-A, scan the appropriate bar code below.

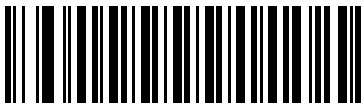

\* Enable UPC-A  
(01h)

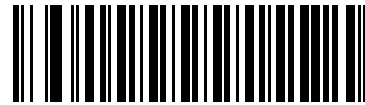

Disable UPC-A  
(00h)

### Enable/Disable UPC-E

#### Parameter # 02h

To enable or disable UPC-E, scan the appropriate bar code below.

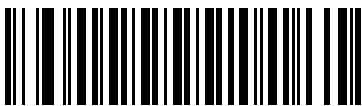

\* Enable UPC-E  
(01h)



Disable UPC-E  
(00h)

## Enable/Disable UPC-E1

### Parameter # 0Ch

UPC-E1 is disabled by default.

To enable or disable UPC-E1, scan the appropriate bar code below.

✓ **NOTE** UPC-E1 is not a UCC (Uniform Code Council) approved symbology.

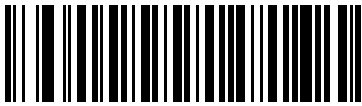

Enable UPC-E1  
(01h)



\*Disable UPC-E1  
(00h)

## Enable/Disable EAN-8/JAN-8

### Parameter # 04h

To enable or disable EAN-8/JAN-8, scan the appropriate bar code below.

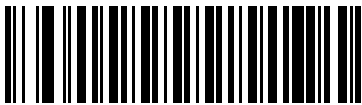

\*Enable EAN-8/JAN-8  
(01h)



Disable EAN-8/JAN-8  
(00h)



## Enable/Disable EAN-13/JAN-13

### Parameter # 03h

To enable or disable EAN-13/JAN-13, scan the appropriate bar code below.

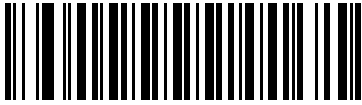

\*Enable EAN-13/JAN-13  
(01h)

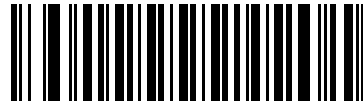

Disable EAN-13/JAN-13  
(00h)

## Enable/Disable Bookland EAN

### Parameter # 53h

To enable or disable Bookland EAN, scan the appropriate bar code below.

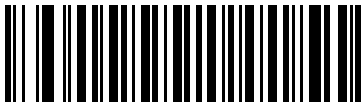

Enable Bookland EAN  
(01h)



\* Disable Bookland EAN  
(00h)



**NOTE** If you enable Bookland EAN, select a [Bookland ISBN Format on page 12-21](#). Also select either Decode UPC/EAN Supplementals, Autodiscriminate UPC/EAN Supplementals, or Enable 978/979 Supplemental Mode in [Decode UPC/EAN/JAN Supplementals on page 12-10](#).

## Decode UPC/EAN/JAN Supplementals

### Parameter # 10h

Supplementals are bar codes appended according to specific format conventions (e.g., UPC A+2, UPC E+2, EAN 13+2). The following options are available:

- If you select **Ignore UPC/EAN with Supplementals**, and the device is presented with a UPC/EAN plus supplemental symbol, the device decodes UPC/EAN and ignores the supplemental characters.
- If you select **Decode UPC/EAN with Supplementals**, the device only decodes UPC/EAN symbols with supplemental characters, and ignores symbols without supplementals.
- If you select **Autodiscriminate UPC/EAN Supplementals**, the device decodes UPC/EAN symbols with supplemental characters immediately. If the symbol does not have a supplemental, the device must decode the bar code the number of times set via [UPC/EAN/JAN Supplemental Redundancy on page 12-13](#) before transmitting its data to confirm that there is no supplemental.
- If you select one of the following **Supplemental Mode** options, the device immediately transmits EAN-13 bar codes starting with that prefix that have supplemental characters. If the symbol does not have a supplemental, the device must decode the bar code the number of times set via [UPC/EAN/JAN Supplemental Redundancy on page 12-13](#) before transmitting its data to confirm that there is no supplemental. The device transmits UPC/EAN bar codes that do not have that prefix immediately.
  - **Enable 378/379 Supplemental Mode**
  - **Enable 978/979 Supplemental Mode**

✓ **NOTE** If you select 978/979 Supplemental Mode and are scanning Bookland EAN bar codes, see [Enable/Disable Bookland EAN on page 12-9](#) to enable Bookland EAN, and select a format using [Bookland ISBN Format on page 12-21](#).

- **Enable 977 Supplemental Mode**
- **Enable 414/419/434/439 Supplemental Mode**
- **Enable 491 Supplemental Mode**
- **Enable Smart Supplemental Mode** - applies to EAN-13 bar codes starting with any prefix listed previously.
- **Supplemental User-Programmable Type 1** - applies to EAN-13 bar codes starting with a 3-digit user-defined prefix. Set this 3-digit prefix using [User-Programmable Supplementals on page 12-13](#).
- **Supplemental User-Programmable Type 1 and 2** - applies to EAN-13 bar codes starting with either of two 3-digit user-defined prefixes. Set the 3-digit prefixes using [User-Programmable Supplementals on page 12-13](#).
- **Smart Supplemental Plus User-Programmable 1** - applies to EAN-13 bar codes starting with any prefix listed previously or the user-defined prefix set using [User-Programmable Supplementals on page 12-13](#).
- **Smart Supplemental Plus User-Programmable 1 and 2** - applies to EAN-13 bar codes starting with any prefix listed previously or one of the two user-defined prefixes set using [User-Programmable Supplementals on page 12-13](#).

✓ **NOTE** To minimize the risk of invalid data transmission, select either to decode or ignore supplemental characters.

## Decode UPC/EAN/JAN Supplementals (continued)

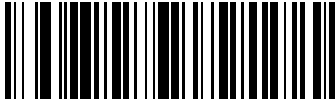

Decode UPC/EAN/JAN Only With Supplementals  
(01h)



\*Ignore Supplementals  
(00h)

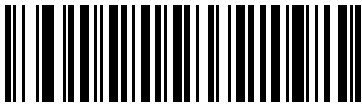

Autodiscriminate UPC/EAN/JAN Supplementals  
(02h)



Enable 378/379 Supplemental Mode  
(04h)



Enable 978/979 Supplemental Mode  
(05h)



Enable 977 Supplemental Mode  
(07h)

## Decode UPC/EAN/JAN Supplementals (continued)



Enable 414/419/434/439 Supplemental Mode  
(06h)



Enable 491 Supplemental Mode  
(08h)



Enable Smart Supplemental Mode  
(03h)



Supplemental User-Programmable Type 1  
(09h)



Supplemental User-Programmable Type 1 and 2  
(0Ah)



Smart Supplemental Plus User-Programmable 1  
(0Bh)



Smart Supplemental Plus User-Programmable 1 and 2  
(0Ch)

## User-Programmable Supplementals

### Supplemental 1: Parameter # F1h 43h

### Supplemental 2: Parameter # F1h 44h

If you selected a Supplemental User-Programmable option from [Decode UPC/EAN/JAN Supplementals on page 12-10](#), select **User-Programmable Supplemental 1** to set the 3-digit prefix. Then select the 3 digits using the numeric bar codes beginning on [page D-1](#). Select **User-Programmable Supplemental 2** to set a second 3-digit prefix. Then select the 3 digits using the numeric bar codes beginning on [page D-1](#).

✓ **NOTE** **User-Programmable Supplemental 1** and **User-Programmable Supplemental 2** are currently not supported.



User-Programmable Supplemental 1



User-Programmable Supplemental 2

## UPC/EAN/JAN Supplemental Redundancy

### Parameter # 50h

If you selected **Autodiscriminate UPC/EAN/JAN Supplementals**, this option adjusts the number of times to decode a symbol without supplementals before transmission. The range is from two to thirty times. Five or above is recommended when decoding a mix of UPC/EAN/JAN symbols with and without supplementals. The default is 10.

Scan the bar code below to set a decode redundancy value. Next, scan two numeric bar codes in [Appendix D, Numeric Bar Codes](#). Enter a leading zero for single digit numbers. To correct an error or change a selection, scan [Cancel on page D-3](#).

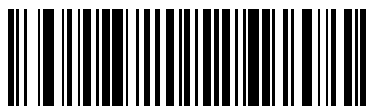

UPC/EAN/JAN Supplemental Redundancy

## UPC/EAN/JAN Supplemental AIM ID Format

### Parameter # F1h A0h

Select an output format when reporting UPC/EAN/JAN bar codes with supplementals with AIM ID enabled:

- Separate - UPC/EAN with supplementals transmit as ]E<0 or 4><data>]E<1 or 2>[supp data]
- Combined - EAN-8 with supplementals transmit as ]E4<data>]E<1 or 2>[supp data]  
All other UPC/EAN with supplementals transmit as ]E3<data+supps>



Separate  
(00h)

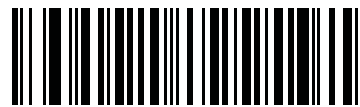

\*Combined  
(01h)

## Transmit UPC-A Check Digit

### Parameter # 28h

The check digit is the last character of the symbol used to verify the integrity of the data. Scan the appropriate bar code below to transmit the bar code data with or without the UPC-A check digit. It is always verified to guarantee the integrity of the data.

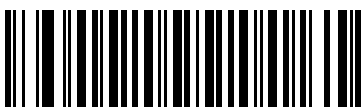

\*Transmit UPC-A Check Digit  
(01h)

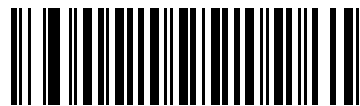

Do Not Transmit UPC-A Check Digit  
(00h)

## Transmit UPC-E Check Digit

### Parameter # 29h

The check digit is the last character of the symbol used to verify the integrity of the data. Scan the appropriate bar code below to transmit the bar code data with or without the UPC-E check digit. It is always verified to guarantee the integrity of the data.

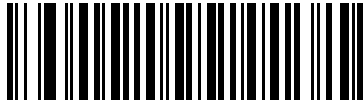

**\*Transmit UPC-E Check Digit  
(01h)**

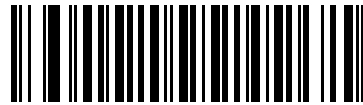

**Do Not Transmit UPC-E Check Digit  
(00h)**

## Transmit UPC-E1 Check Digit

### Parameter # 2Ah

The check digit is the last character of the symbol used to verify the integrity of the data. Scan the appropriate bar code below to transmit the bar code data with or without the UPC-E1 check digit. It is always verified to guarantee the integrity of the data.

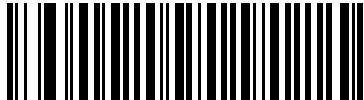

\*Transmit UPC-E1 Check Digit  
(01h)

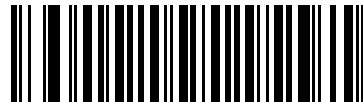

Do Not Transmit UPC-E1 Check Digit  
(00h)

## UPC-A Preamble

### Parameter # 22h

Preamble characters are part of the UPC symbol, and include Country Code and System Character. There are three options for transmitting a UPC-A preamble to the host device: transmit System Character only, transmit System Character and Country Code ("0" for USA), and transmit no preamble. Select the appropriate option to match the host system.

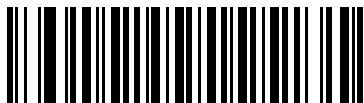

No Preamble (<DATA>)  
(00h)



\*System Character (<SYSTEM CHARACTER> <DATA>)  
(01h)

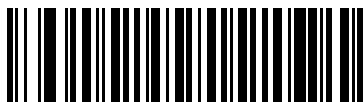

System Character & Country Code  
(< COUNTRY CODE> <SYSTEM CHARACTER> <DATA>)  
(02h)



## UPC-E Preamble

### Parameter # 23h

Preamble characters are part of the UPC symbol, and include Country Code and System Character. There are three options for transmitting a UPC-E preamble to the host device: transmit System Character only, transmit System Character and Country Code ("0" for USA), and transmit no preamble. Select the appropriate option to match the host system.

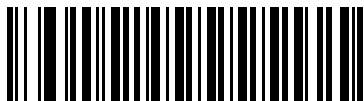

No Preamble (<DATA>)  
(00h)



\*System Character (<SYSTEM CHARACTER> <DATA>)  
(01h)

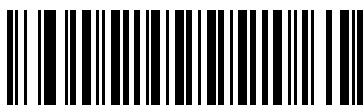

System Character & Country Code  
(< COUNTRY CODE> <SYSTEM CHARACTER> <DATA>)  
(02h)

## UPC-E1 Preamble

### Parameter # 24h

Preamble characters are part of the UPC symbol, and include Country Code and System Character. There are three options for transmitting a UPC-E1 preamble to the host device: transmit System Character only, transmit System Character and Country Code ("0" for USA), and transmit no preamble. Select the appropriate option to match the host system.

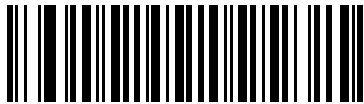

No Preamble (<DATA>)  
(00h)

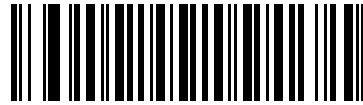

\*System Character (<SYSTEM CHARACTER> <DATA>)  
(01h)

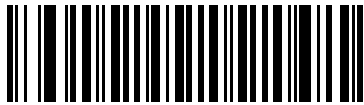

System Character & Country Code  
(< COUNTRY CODE> <SYSTEM CHARACTER> <DATA>)  
(02h)

## Convert UPC-E to UPC-A

### Parameter # 25h

Enable this to convert UPC-E (zero suppressed) decoded data to UPC-A format before transmission. After conversion, the data follows UPC-A format and is affected by UPC-A programming selections (e.g., Preamble, Check Digit).

Disable this to transmit UPC-E decoded data as UPC-E data, without conversion.

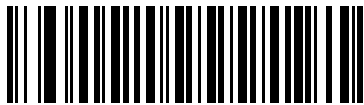

Convert UPC-E to UPC-A (Enable)  
(01h)

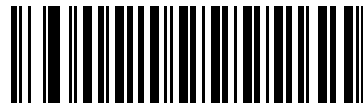

\*Do Not Convert UPC-E to UPC-A (Disable)  
(00h)

## Convert UPC-E1 to UPC-A

### Parameter # 26h

Enable this to convert UPC-E1 decoded data to UPC-A format before transmission. After conversion, the data follows UPC-A format and is affected by UPC-A programming selections (e.g., Preamble, Check Digit).

Disable this to transmit UPC-E1 decoded data as UPC-E1 data, without conversion.

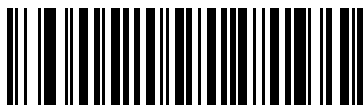

Convert UPC-E1 to UPC-A (Enable)  
(01h)

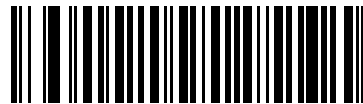

\*Do Not Convert UPC-E1 to UPC-A (Disable)  
(00h)

## EAN-8/JAN-8 Extend

### Parameter # 27h

Enable this parameter to add five leading zeros to decoded EAN-8 symbols to make them compatible in format to EAN-13 symbols.

Disable this to transmit EAN-8 symbols as is.



**Enable EAN/JAN Zero Extend  
(01h)**

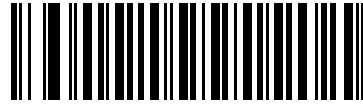

**\*Disable EAN/JAN Zero Extend  
(00h)**

## Bookland ISBN Format

### Parameter # F1h 40h

If you enabled Bookland EAN using [Enable/Disable Bookland EAN on page 12-9](#), select one of the following formats for Bookland data:

- **Bookland ISBN-10** - The device reports Bookland data starting with 978 in traditional 10-digit format with the special Bookland check digit for backward-compatibility. Data starting with 979 is not considered Bookland in this mode.
- **Bookland ISBN-13** - The device reports Bookland data (starting with either 978 or 979) as EAN-13 in 13-digit format to meet the 2007 ISBN-13 protocol.



\*Bookland ISBN-10  
(00h)



Bookland ISBN-13  
(01h)



**NOTE** For Bookland EAN to function properly, first enable Bookland EAN using [Enable/Disable Bookland EAN on page 12-9](#), then select either Decode UPC/EAN Supplementals, Autodiscriminate UPC/EAN Supplementals, or Enable 978/979 Supplemental Mode in [Decode UPC/EAN/JAN Supplementals on page 12-10](#).

## UCC Coupon Extended Code

### Parameter # 55h

Enable this parameter to decode UPC-A bar codes starting with digit '5', EAN-13 bar codes starting with digit '99', and UPC-A/GS1-128 Coupon Codes. UPCA, EAN-13, and GS1-128 must be enabled to scan all types of Coupon Codes.



\*Enable UCC Coupon Extended Code  
(01h)



Disable UCC Coupon Extended Code  
(00h)



**NOTE** See [UPC/EAN/JAN Supplemental Redundancy on page 12-13](#) to control autodiscrimination of the GS1-128 (right half) of a coupon code.

## Coupon Report

### Parameter # F1h DAh

Traditional coupon symbols (old coupon symbols) are composed of two bar codes: UPC/EAN and Code128. A new coupon symbol is composed of a single Databar Expanded bar code. The new coupon format offers more options for purchase values (up to \$999.99) and supports complex discount offers such as a second purchase requirement.

An interim coupon symbol also exists that contains both types of bar codes: UPC/EAN and Databar Expanded. This format accommodates both retailers that do not recognize or use the additional information included in the new coupon symbol, as well as those who can process new coupon symbols.

Scan a bar code below to select one of the following options for decoding coupon symbols:

- **Old Coupon Symbols** - Scanning an old coupon symbol reports both UPC and Code 128, scanning an interim coupon symbol reports UPC, and scanning a new coupon symbol reports nothing (no decode).
- **New Coupon Symbols** - Scanning an old coupon symbol reports either UPC or Code 128, and scanning an interim coupon symbol or a new coupon symbol reports Databar Expanded.

- **Both Coupon Formats** - Scanning an old coupon symbol reports both UPC and Code 128, and scanning an interim coupon symbol or a new coupon symbol reports Databar Expanded.



**Old Coupon Symbols  
(00h)**



**\*New Coupon Symbols  
(01h)**



**Both Coupon Formats  
(02h)**

## ISSN EAN

### Parameter # F1h 69h

To enable or disable ISSN EAN, scan the appropriate bar code below.



**Enable ISSN EAN  
(01h)**

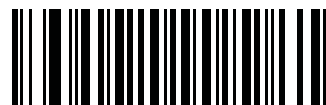

**\*Disable ISSN EAN  
(00h)**

## Code 128

### Enable/Disable Code 128

#### Parameter # 08h

To enable or disable Code 128, scan the appropriate bar code below.

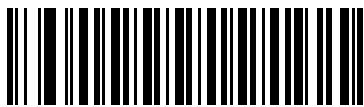

\*Enable Code 128  
(01h)



Disable Code 128  
(00h)

### Set Lengths for Code 128

#### Parameter # L1 = D1h, L2 = D2h

The length of a code refers to the number of characters (i.e., human readable characters), including check digit(s) the code contains. Set lengths for Code 128 to any length, one or two discrete lengths, or lengths within a specific range.

✓ **NOTE** When setting lengths for different bar code types, enter a leading zero for single digit numbers.

- **One Discrete Length** - Select this option to decode only Code 128 symbols containing a selected length. Select the length using the numeric bar codes in [Appendix D, Numeric Bar Codes](#). For example, to decode only Code 128 symbols with 14 characters, scan **Code 128 - One Discrete Length**, then scan **1** followed by **4**. To correct an error or change the selection, scan [Cancel on page D-3](#).
- **Two Discrete Lengths** - Select this option to decode only Code 128 symbols containing either of two selected lengths. Select lengths using the numeric bar codes in [Appendix D, Numeric Bar Codes](#). For example, to decode only Code 128 symbols containing either 2 or 14 characters, select **Code 128 - Two Discrete Lengths**, then scan **0, 2, 1**, and then **4**. To correct an error or change the selection, scan [Cancel on page D-3](#).
- **Length Within Range** - Select this option to decode a Code 128 symbol with a specific length range. Select lengths using numeric bar codes in [Appendix D, Numeric Bar Codes](#). For example, to decode Code 128 symbols containing between 4 and 12 characters, first scan **Code 128 - Length Within Range**. Then scan **0, 4, 1**, and **2** (enter a leading zero for single digit numbers). To correct an error or change the selection, scan [Cancel on page D-3](#).
- **Any Length** - Select this option to decode Code 128 symbols containing any number of characters within the device's capability.



### Set Lengths for Code 128 (continued)

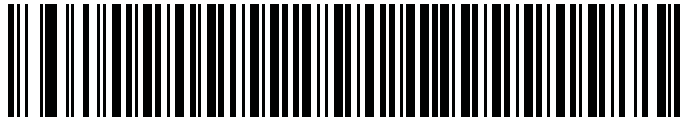

Code 128 - One Discrete Length

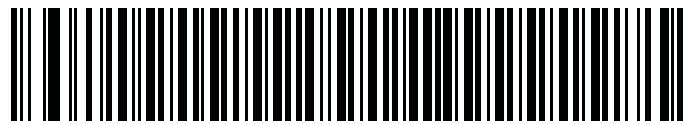

Code 128 - Two Discrete Lengths

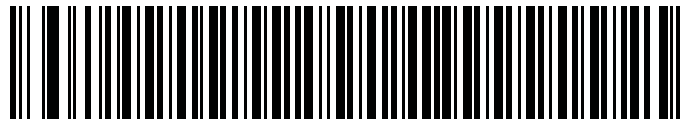

Code 128 - Length Within Range

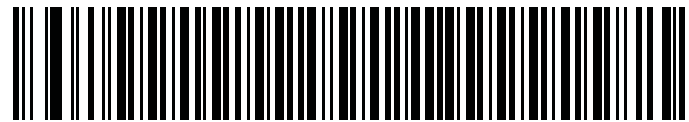

\*Code 128 - Any Length

## Enable/Disable GS1-128 (formerly UCC/EAN-128)

### Parameter # 0Eh

✓ **NOTE** Code128 must be enabled prior to using this symbology.

To enable or disable GS1-128, scan the appropriate bar code below.

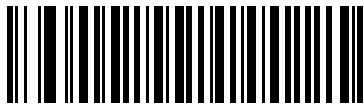

**\*Enable GS1-128  
(01h)**

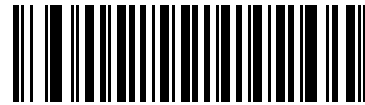

**Disable GS1-128  
(00h)**

## Enable/Disable ISBT 128

### Parameter # 54h

✓ **NOTE** Code128 must be enabled prior to using this symbology.

ISBT 128 is a variant of Code 128 used in the blood bank industry. Scan a bar code below to enable or disable ISBT 128. If necessary, the host must perform concatenation of the ISBT data.



**\*Enable ISBT 128  
(01h)**

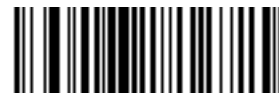

**Disable ISBT 128  
(00h)**

## ISBT Concatenation

### Parameter # F1h 41h

Select an option for concatenating pairs of ISBT code types:

- If you select **Disable ISBT Concatenation**, the device does not concatenate pairs of ISBT codes it encounters.
- If you select **Enable ISBT Concatenation**, there must be two ISBT codes in order for the device to decode and perform concatenation. The device does not decode single ISBT symbols.
- If you select **Autodiscriminate ISBT Concatenation**, the device decodes and concatenates pairs of ISBT codes immediately.

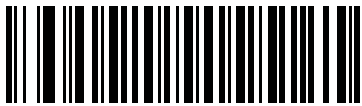

\*Disable ISBT Concatenation  
(00h)



Enable ISBT Concatenation  
(01h)



Autodiscriminate ISBT Concatenation  
(02h)

## Check ISBT Table

### Parameter # F1h 42h

The ISBT specification includes a table that lists several types of ISBT bar codes that are commonly used in pairs. If you set **ISBT Concatenation** to **Enable**, enable **Check ISBT Table** to concatenate only those pairs found in this table. Other types of ISBT codes are not concatenated.



\*Enable Check ISBT Table  
(01h)



Disable Check ISBT Table  
(00h)

---

## Code 39

### Enable/Disable Code 39

#### Parameter # 00h

To enable or disable Code 39, scan the appropriate bar code below.

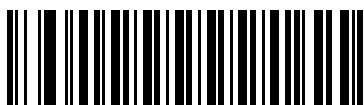

\*Enable Code 39  
(01h)



Disable Code 39  
(00h)

### Enable/Disable Trioptic Code 39

#### Parameter # 0Dh

Trioptic Code 39 is a variant of Code 39 used in the marking of computer tape cartridges. Trioptic Code 39 symbols always contain six characters. To enable or disable Trioptic Code 39, scan the appropriate bar code below.

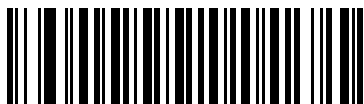

Enable Trioptic Code 39  
(01h)



\*Disable Trioptic Code 39  
(00h)



**NOTE** You cannot enable Trioptic Code 39 and Code 39 Full ASCII simultaneously.

## Convert Code 39 to Code 32

### Parameter # 56h

Code 32 is a variant of Code 39 used by the Italian pharmaceutical industry. Scan the appropriate bar code below to enable or disable converting Code 39 to Code 32.

✓ **NOTE** Code 39 must be enabled for this parameter to function.

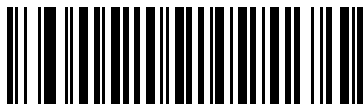

Enable Convert Code 39 to Code 32  
(01h)

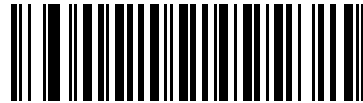

\*Disable Convert Code 39 to Code 32  
(00h)

## Code 32 Prefix

### Parameter # E7h

Scan the appropriate bar code below to enable or disable adding the prefix character “A” to all Code 32 bar codes.

✓ **NOTE** Convert Code 39 to Code 32 must be enabled for this parameter to function.

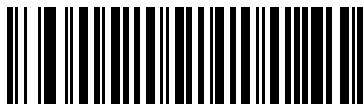

Enable Code 32 Prefix  
(01h)

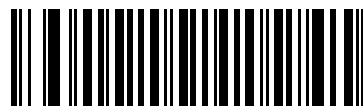

\*Disable Code 32 Prefix  
(00h)

## Set Lengths for Code 39

### Parameter # L1 = 12h, L2 = 13h

The length of a code refers to the number of characters (i.e., human readable characters), including check digit(s) the code contains. Set lengths for Code 39 to any length, one or two discrete lengths, or lengths within a specific range. If Code 39 Full ASCII is enabled, **Length Within a Range** or **Any Length** are the preferred options.

✓ **NOTE** When setting lengths for different bar code types, enter a leading zero for single digit numbers.

- **One Discrete Length** - Select this option to decode only Code 39 symbols containing a selected length. Select the length using the numeric bar codes in [Appendix D, Numeric Bar Codes](#). For example, to decode only Code 39 symbols with 14 characters, scan **Code 39 - One Discrete Length**, then scan **1** followed by **4**. To correct an error or change the selection, scan [Cancel on page D-3](#).
- **Two Discrete Lengths** - Select this option to decode only Code 39 symbols containing either of two selected lengths. Select lengths using the numeric bar codes in [Appendix D, Numeric Bar Codes](#). For example, to decode only Code 39 symbols containing either 2 or 14 characters, select **Code 39 - Two Discrete Lengths**, then scan **0**, **2**, **1**, and then **4**. To correct an error or change the selection, scan [Cancel on page D-3](#).
- **Length Within Range** - Select this option to decode a Code 39 symbol with a specific length range. Select lengths using numeric bar codes in [Appendix D, Numeric Bar Codes](#). For example, to decode Code 39 symbols containing between 4 and 12 characters, first scan **Code 39 - Length Within Range**. Then scan **0**, **4**, **1**, and **2** (enter a leading zero for single digit numbers). To correct an error or change the selection, scan [Cancel on page D-3](#).
- **Any Length** - Select this option to decode Code 39 symbols containing any number of characters within the device's capability.



Code 39 - One Discrete Length



Code 39 - Two Discrete Lengths



Code 39 - Length Within Range



Code 39 - Any Length

## Code 39 Check Digit Verification

### Parameter # 30h

Enable this feature to check the integrity of all Code 39 symbols to verify that the data complies with specified check digit algorithm. Only Code 39 symbols which include a modulo 43 check digit are decoded. Enable this feature if the Code 39 symbols contain a Modulo 43 check digit.

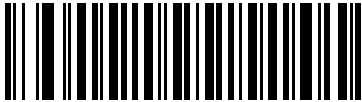

Enable Code 39 Check Digit  
(01h)

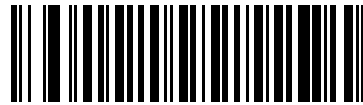

\*Disable Code 39 Check Digit  
(00h)

## Transmit Code 39 Check Digit

### Parameter # 2Bh

Scan a bar code below to transmit Code 39 data with or without the check digit.

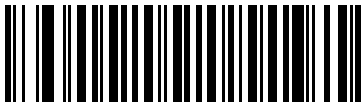

Transmit Code 39 Check Digit (Enable)  
(01h)



\*Do Not Transmit Code 39 Check Digit (Disable)  
(00h)



**NOTE** Code 39 Check Digit Verification must be enabled for this parameter to function.



## Code 39 Full ASCII Conversion

### Parameter # 11h

Code 39 Full ASCII is a variant of Code 39 which pairs characters to encode the full ASCII character set. To enable or disable Code 39 Full ASCII, scan the appropriate bar code below.

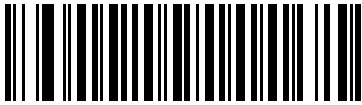

Enable Code 39 Full ASCII  
(01h)

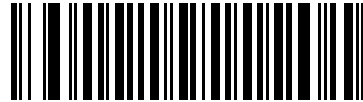

\*Disable Code 39 Full ASCII  
(00h)



**NOTE** You cannot enable Trioptic Code 39 and Code 39 Full ASCII simultaneously.

Code 39 Full ASCII to Full ASCII Correlation is host-dependent, and is therefore described in the ASCII Character Set Table for the appropriate interface. See the [ASCII Character Set for USB on page 9-20](#) or the [ASCII Character Set for RS-232 on page 8-19](#).

## Code 93

### Enable/Disable Code 93

#### Parameter # 09h

To enable or disable Code 93, scan the appropriate bar code below.

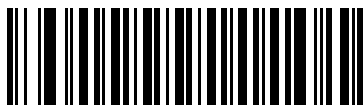

Enable Code 93  
(01h)



\*Disable Code 93  
(00h)

### Set Lengths for Code 93

#### Parameter # L1 = 1Ah, L2 = 1Bh

The length of a code refers to the number of characters (i.e., human readable characters), including check digit(s) the code contains. Set lengths for Code 93 to any length, one or two discrete lengths, or lengths within a specific range.

- **One Discrete Length** - Select this option to decode only Code 93 symbols containing a selected length. Select the length using the numeric bar codes in [Appendix D, Numeric Bar Codes](#). For example, to decode only Code 93 symbols with 14 characters, scan **Code 93 - One Discrete Length**, then scan **1** followed by **4**. To correct an error or to change the selection, scan [Cancel on page D-3](#).
- **Two Discrete Lengths** - Select this option to decode only Code 93 symbols containing either of two selected lengths. Select lengths using the numeric bar codes in [Appendix D, Numeric Bar Codes](#). For example, to decode only Code 93 symbols containing either 2 or 14 characters, select **Code 93 - Two Discrete Lengths**, then scan **0, 2, 1**, and then **4**. To correct an error or to change the selection, scan [Cancel on page D-3](#).
- **Length Within Range** - Select this option to decode a Code 93 symbol with a specific length range. Select lengths using the numeric bar codes in [Appendix D, Numeric Bar Codes](#). For example, to decode Code 93 symbols containing between 4 and 12 characters, first scan **Code 93 - Length Within Range**. Then scan **0, 4, 1**, and **2** (enter a leading zero for single digit numbers). To correct an error or change the selection, scan [Cancel on page D-3](#).
- **Any Length** - Scan this option to decode Code 93 symbols containing any number of characters within the device's capability.

### Set Lengths for Code 93 (continued)



Code 93 - One Discrete Length



Code 93 - Two Discrete Lengths



Code 93 - Length Within Range



Code 93 - Any Length

## Code 11

### Code 11

#### Parameter # 0Ah

To enable or disable Code 11, scan the appropriate bar code below.

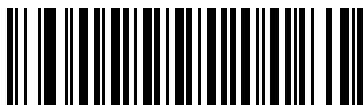

Enable Code 11  
(01h)



\*Disable Code 11  
(00h)

### Set Lengths for Code 11

#### Parameter # L1 = 1Ch, L2 = 1Dh

The length of a code refers to the number of characters (i.e., human readable characters), including check digit(s) the code contains. Set lengths for Code 11 to any length, one or two discrete lengths, or lengths within a specific range.

- One Discrete Length** - Select this option to decode only Code 11 symbols containing a selected length. Select the length using the numeric bar codes in [Appendix D, Numeric Bar Codes](#). For example, to decode only Code 11 symbols with 14 characters, scan **Code 11 - One Discrete Length**, then scan **1** followed by **4**. To correct an error or to change the selection, scan [Cancel on page D-3](#).
- Two Discrete Lengths** - Select this option to decode only Code 11 symbols containing either of two selected lengths. Select lengths using the numeric bar codes in [Appendix D, Numeric Bar Codes](#). For example, to decode only Code 11 symbols containing either 2 or 14 characters, select **Code 11 - Two Discrete Lengths**, then scan **0**, **2**, **1**, and then **4**. To correct an error or to change the selection, scan [Cancel on page D-3](#).
- Length Within Range** - Select this option to decode a Code 11 symbol with a specific length range. Select lengths using numeric bar codes in [Appendix D, Numeric Bar Codes](#). For example, to decode Code 11 symbols containing between 4 and 12 characters, first scan **Code 11 - Length Within Range**. Then scan **0**, **4**, **1**, and **2** (enter a leading zero for single digit numbers). To correct an error or change the selection, scan [Cancel on page D-3](#).
- Any Length** - Scan this option to decode Code 11 symbols containing any number of characters within the device's capability.

### Set Lengths for Code 11 (continued)



Code 11 - One Discrete Length



Code 11 - Two Discrete Lengths



Code 11 - Length Within Range



Code 11 - Any Length

## Code 11 Check Digit Verification

### Parameter # 34h

This feature allows the device to check the integrity of all Code 11 symbols to verify that the data complies with the specified check digit algorithm. This selects the check digit mechanism for the decoded Code 11 bar code. The options are to check for one check digit, check for two check digits, or disable the feature.

To enable this feature, scan the bar code below corresponding to the number of check digits encoded in the Code 11 symbols.

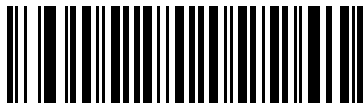

**\*Disable  
(00h)**

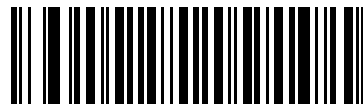

**One Check Digit  
(01h)**

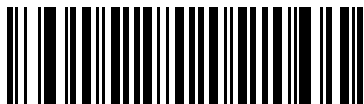

**Two Check Digits  
(02h)**

## Transmit Code 11 Check Digits

### Parameter # 2Fh

This feature selects whether or not to transmit the Code 11 check digit(s).



Transmit Code 11 Check Digit(s) (Enable)  
(01h)

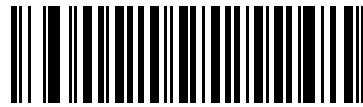

\*Do Not Transmit Code 11 Check Digit(s) (Disable)  
(00h)



**NOTE** Code 11 Check Digit Verification must be enabled for this parameter to function.

---

## Interleaved 2 of 5 (ITF)

### Enable/Disable Interleaved 2 of 5

#### Parameter # 06h

To enable or disable Interleaved 2 of 5, scan the appropriate bar code below, and select an Interleaved 2 of 5 length from the following pages.

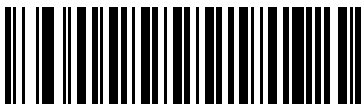

Enable Interleaved 2 of 5  
(01h)

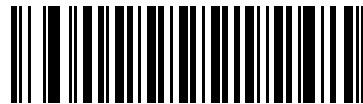

\*Disable Interleaved 2 of 5  
(00h)

## Set Lengths for Interleaved 2 of 5

### Parameter # L1 = 16h, L2 = 17h

The length of a code refers to the number of characters (i.e., human readable characters), including check digit(s) the code contains. Set lengths for I 2 of 5 to any length, one or two discrete lengths, or lengths within a specific range. The range for Interleaved 2 of 5 lengths is 0 - 55.

- **One Discrete Length** - Select this option to decode only I 2 of 5 symbols containing a selected length. Select the length using the numeric bar codes in [Appendix D, Numeric Bar Codes](#). For example, to decode only I 2 of 5 symbols with 14 characters, scan **I 2 of 5 - One Discrete Length**, then scan **1** followed by **4**. To correct an error or to change the selection, scan [Cancel on page D-3](#).
- **Two Discrete Lengths** - Select this option to decode only I 2 of 5 symbols containing either of two selected lengths. Select lengths using the numeric bar codes in [Appendix D, Numeric Bar Codes](#). For example, to decode only I 2 of 5 symbols containing either 2 or 14 characters, select **I 2 of 5 - Two Discrete Lengths**, then scan **0, 2, 1**, and then **4**. To correct an error or to change the selection, scan [Cancel on page D-3](#).
- **Length Within Range** - Select this option to decode an I 2 of 5 symbol with a specific length range. Select lengths using numeric bar codes in [Appendix D, Numeric Bar Codes](#). For example, to decode I 2 of 5 symbols containing between 4 and 12 characters, first scan **I 2 of 5 - Length Within Range**. Then scan **0, 4, 1**, and **2** (enter a leading zero for single digit numbers). To correct an error or change the selection, scan [Cancel on page D-3](#).
- **Any Length** - Scan this option to decode I 2 of 5 symbols containing any number of characters within the device's capability.

✓ **NOTE** Due to the construction of the I 2 of 5 symbology, it is possible for a scan line covering only a portion of the code to transmit as a complete scan, yielding less data than is encoded in the bar code. To prevent this, select specific lengths (I 2 of 5 - One Discrete Length, Two Discrete Lengths) for I 2 of 5 applications.



### Set Lengths for Interleaved 2 of 5 (continued)



I 2 of 5 - One Discrete Length



I 2 of 5 - Two Discrete Lengths



I 2 of 5 - Length Within Range



I 2 of 5 - Any Length

## I 2 of 5 Check Digit Verification

### Parameter # 31h

Enable this feature to check the integrity of all I 2 of 5 symbols to verify the data complies with either the specified Uniform Symbology Specification (USS), or the Optical Product Code Council (OPCC) check digit algorithm.



**\*Disable  
(00h)**



**USS Check Digit  
(01h)**



**OPCC Check Digit  
(02h)**

## Transmit I 2 of 5 Check Digit

### Parameter # 2Ch

Scan the appropriate bar code below to transmit I 2 of 5 data with or without the check digit.

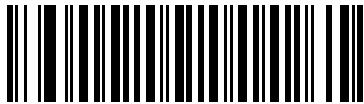

**Transmit I 2 of 5 Check Digit (Enable)  
(01h)**



**\*Do Not Transmit I 2 of 5 Check Digit (Disable)  
(00h)**

## Convert I 2 of 5 to EAN-13

### Parameter # 52h

Enable this parameter to convert 14-character I 2 of 5 codes to EAN-13, and transmit to the host as EAN-13. To accomplish this, the I 2 of 5 code must be enabled, and the code must have a leading zero and a valid EAN-13 check digit.

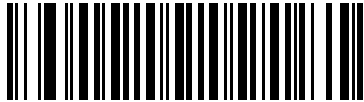

Convert I 2 of 5 to EAN-13 (Enable)  
(01h)

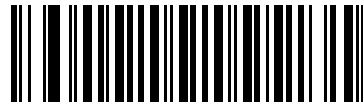

\*Do Not Convert I 2 of 5 to EAN-13 (Disable)  
(00h)

---

## Discrete 2 of 5 (DTF)

### Enable/Disable Discrete 2 of 5

#### Parameter # 05h

To enable or disable Discrete 2 of 5, scan the appropriate bar code below.



Enable Discrete 2 of 5  
(01h)



\*Disable Discrete 2 of 5  
(00h)

## Set Lengths for Discrete 2 of 5

### Parameter # L1 = 14h, L2 = 15h

The length of a code refers to the number of characters (i.e., human readable characters), including check digit(s) the code contains. Set lengths for D 2 of 5 to any length, one or two discrete lengths, or lengths within a specific range. The range for Discrete 2 of 5 lengths is 0 - 55.

- **One Discrete Length** - Select this option to decode only D 2 of 5 symbols containing a selected length. Select the length using the numeric bar codes in [Appendix D, Numeric Bar Codes](#). For example, to decode only D 2 of 5 symbols with 14 characters, scan **D 2 of 5 - One Discrete Length**, then scan **1** followed by **4**. To correct an error or to change the selection, scan [Cancel on page D-3](#).
- **Two Discrete Lengths** - Select this option to decode only D 2 of 5 symbols containing either of two selected lengths. Select lengths using the numeric bar codes in [Appendix D, Numeric Bar Codes](#). For example, to decode only D 2 of 5 symbols containing either 2 or 14 characters, select **D 2 of 5 - Two Discrete Lengths**, then scan **0**, **2**, **1**, and then **4**. To correct an error or to change the selection, scan [Cancel on page D-3](#).
- **Length Within Range** - Select this option to decode a D 2 of 5 symbol with a specific length range. Select lengths using numeric bar codes in [Appendix D, Numeric Bar Codes](#). For example, to decode D 2 of 5 symbols containing between 4 and 12 characters, first scan **D 2 of 5 - Length Within Range**. Then scan **0**, **4**, **1**, and **2** (enter a leading zero for single digit numbers). To correct an error or change the selection, scan [Cancel on page D-3](#).
- **Any Length** - Scan this option to decode D 2 of 5 symbols containing any number of characters within the device's capability.

✓ **NOTE** Due to the construction of the D 2 of 5 symbology, it is possible for a scan line covering only a portion of the code to transmit as a complete scan, yielding less data than is encoded in the bar code. To prevent this, select specific lengths (**D 2 of 5 - One Discrete Length, Two Discrete Lengths**) for D 2 of 5 applications.

### Set Lengths for Discrete 2 of 5 (continued)



D 2 of 5 - One Discrete Length



D 2 of 5 - Two Discrete Lengths



D 2 of 5 - Length Within Range



D 2 of 5 - Any Length

## Codabar (NW - 7)

### Enable/Disable Codabar

#### Parameter # 07h

To enable or disable Codabar, scan the appropriate bar code below.

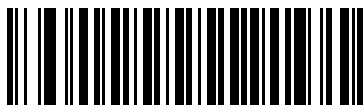

Enable Codabar  
(01h)

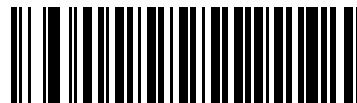

\*Disable Codabar  
(00h)

### Set Lengths for Codabar

#### Parameter # L1 = 18h, L2 = 19h

The length of a code refers to the number of characters (i.e., human readable characters), including check digit(s) the code contains. Set lengths for Codabar to any length, one or two discrete lengths, or lengths within a specific range.

- One Discrete Length** - Select this option to decode only Codabar symbols containing a selected length. Select the length using the numeric bar codes in [Appendix D, Numeric Bar Codes](#). For example, to decode only Codabar symbols with 14 characters, scan **Codabar - One Discrete Length**, then scan **1** followed by **4**. To correct an error or to change the selection, scan [Cancel on page D-3](#).
- Two Discrete Lengths** - Select this option to decode only Codabar symbols containing either of two selected lengths. Select lengths using the numeric bar codes in [Appendix D, Numeric Bar Codes](#). For example, to decode only Codabar symbols containing either 2 or 14 characters, select **Codabar - Two Discrete Lengths**, then scan **0, 2, 1**, and then **4**. To correct an error or to change the selection, scan [Cancel on page D-3](#).
- Length Within Range** - Select this option to decode a Codabar symbol with a specific length range. Select lengths using numeric bar codes in [Appendix D, Numeric Bar Codes](#). For example, to decode Codabar symbols containing between 4 and 12 characters, first scan **Codabar - Length Within Range**. Then scan **0, 4, 1**, and **2** (enter a leading zero for single digit numbers). To correct an error or change the selection, scan [Cancel on page D-3](#).
- Any Length** - Scan this option to decode Codabar symbols containing any number of characters within the device's capability.

### Set Lengths for Codabar (continued)



Codabar - One Discrete Length



Codabar - Two Discrete Lengths



Codabar - Length Within Range



Codabar - Any Length

## CLSI Editing

### Parameter # 36h

Enable this parameter to strip the start and stop characters and insert a space after the first, fifth, and tenth characters of a 14-character Codabar symbol. Enable this feature if the host system requires this data format.

✓ **NOTE** Symbol length does not include start and stop characters.

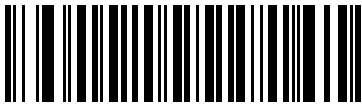

Enable CLSI Editing  
(01h)

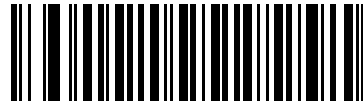

\*Disable CLSI Editing  
(00h)

## NOTIS Editing

### Parameter # 37h

Enable this parameter to strip the start and stop characters from a decoded Codabar symbol. Enable this feature if the host system requires this data format.



Enable NOTIS Editing  
(01h)



\*Disable NOTIS Editing  
(00h)



## Codabar Upper or Lower Case Start/Stop Characters Detection

Parameter # # F2h 57h

Select whether to detect upper case or lower case Codabar start/stop characters.

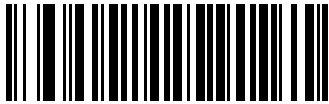

**Lower Case  
(01h)**

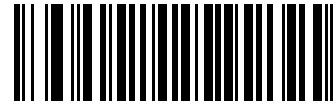

**\*Upper Case  
(00h)**

## MSI

### Enable/Disable MSI

#### Parameter # 0Bh

To enable or disable MSI, scan the appropriate bar code below.

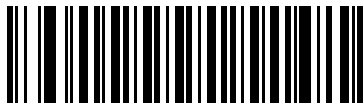

Enable MSI  
(01h)

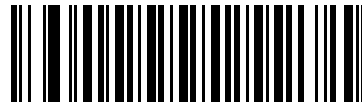

\*Disable MSI  
(00h)

### Set Lengths for MSI

#### Parameter # L1 = 1Eh, L2 = 1Fh

The length of a code refers to the number of characters (i.e., human readable characters), including check digit(s) the code contains. Set lengths for MSI to any length, one or two discrete lengths, or lengths within a specific range.

- **One Discrete Length** - Select this option to decode only MSI symbols containing a selected length. Select the length using the numeric bar codes in [Appendix D, Numeric Bar Codes](#). For example, to decode only MSI symbols with 14 characters, scan **MSI - One Discrete Length**, then scan **1** followed by **4**. To correct an error or to change the selection, scan [Cancel on page D-3](#).
- **Two Discrete Lengths** - Select this option to decode only MSI symbols containing either of two selected lengths. Select lengths using the numeric bar codes in [Appendix D, Numeric Bar Codes](#). For example, to decode only MSI symbols containing either 2 or 14 characters, select **MSI - Two Discrete Lengths**, then scan **0**, **2**, **1**, and then **4**. To correct an error or to change the selection, scan [Cancel on page D-3](#).
- **Length Within Range** - Select this option to decode a MSI symbol with a specific length range. Select lengths using numeric bar codes in [Appendix D, Numeric Bar Codes](#). For example, to decode MSI symbols containing between 4 and 12 characters, first scan **MSI - Length Within Range**. Then scan **0**, **4**, **1**, and **2** (enter a leading zero for single digit numbers). To correct an error or change the selection, scan [Cancel on page D-3](#).
- **Any Length** - Scan this option to decode MSI symbols containing any number of characters within the device's capability.

## Set Lengths for MSI (continued)

- ✓ **NOTE** Due to the construction of the MSI symbology, it is possible for a scan line covering only a portion of the code to transmit as a complete scan, yielding less data than is encoded in the bar code. To prevent this, select specific lengths (**MSI - One Discrete Length, Two Discrete Lengths**) for MSI applications.



**MSI - One Discrete Length**



**MSI - Two Discrete Lengths**



**MSI - Length Within Range**



**MSI - Any Length**

## MSI Check Digits

### Parameter # 32h

With MSI symbols, one check digit is mandatory and always verified by the reader. The second check digit is optional. If the MSI codes include two check digits, scan the **Two MSI Check Digits** bar code to enable verification of the second check digit.

See [MSI Check Digit Algorithm on page 12-53](#) for the selection of second digit algorithms.

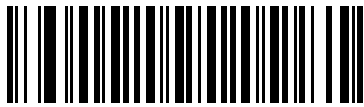

\* One MSI Check Digit  
(00h)

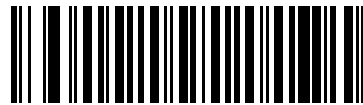

Two MSI Check Digits  
(01h)

## Transmit MSI Check Digit(s)

### Parameter # 2Eh

Scan a bar code below to transmit MSI data with or without the check digit.



Transmit MSI Check Digit(s) (Enable)  
(01h)

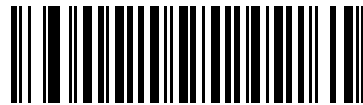

\* Do Not Transmit MSI Check Digit(s) (Disable)  
(00h)

## MSI Check Digit Algorithm

### Parameter # 33h

Two algorithms are possible for the verification of the second MSI check digit. Select the bar code below corresponding to the algorithm used to encode the check digit.

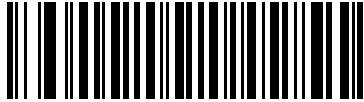

MOD 10/MOD 11  
(00h)



\*MOD 10/MOD 10  
(01h)

## Matrix 2 of 5

### Enable/Disable Matrix 2 of 5

#### Parameter # F1h 6Ah

To enable or disable Matrix 2 of 5, scan the appropriate bar code below.



Enable Matrix 2 of 5  
(01h)



\*Disable Matrix 2 of 5  
(00h)

### Set Lengths for Matrix 2 of 5

#### Parameter # L1 = F1h 6Bh, L2 = F1h 6Ch

The length of a code refers to the number of characters (i.e., human readable characters), including check digit(s) the code contains. Set lengths for Matrix 2 of 5 to any length, one or two discrete lengths, or lengths within a specific range.

- One Discrete Length - Select this option to decode only Matrix 2 of 5 symbols containing a selected length. Select the length using the [Numeric Bar Codes on page D-1](#). For example, to decode only Matrix 2 of 5 symbols with 14 characters, scan **Matrix 2 of 5 - One Discrete Length**, then scan 1 followed by 4. To correct an error or to change the selection, scan [Cancel on page D-3](#).
- Two Discrete Lengths - Select this option to decode only Matrix 2 of 5 symbols containing either of two selected lengths. Select lengths using the [Numeric Bar Codes on page D-1](#). For example, to decode only Matrix 2 of 5 symbols containing either 2 or 14 characters, select **Matrix 2 of 5 - Two Discrete Lengths**, then scan 0, 2, 1, and then 4. To correct an error or to change the selection, scan [Cancel on page D-3](#).
- Length Within Range - Select this option to decode a Matrix 2 of 5 symbol with a specific length range. Select lengths using the [Numeric Bar Codes on page D-1](#). For example, to decode Matrix 2 of 5 symbols containing between 4 and 12 characters, first scan **Matrix 2 of 5 - Length Within Range**. Then scan 0, 4, 1, and 2 (enter a leading zero for single digit numbers). To correct an error or change the selection, scan [Cancel on page D-3](#).
- Any Length - Scan this option to decode Matrix 2 of 5 symbols containing any number of characters within the decoder's capability.

### Set Lengths for Matrix 2 of 5 (continued)



**\*Matrix 2 of 5 - One Discrete Length  
(Default: 14)**

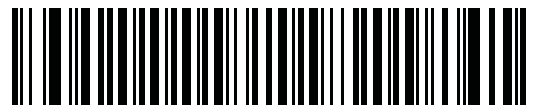

**Matrix 2 of 5 - Two Discrete Lengths**

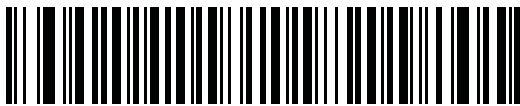

**Matrix 2 of 5 - Length Within Range**



**Matrix 2 of 5 - Any Length**

## Matrix 2 of 5 Check Digit

### Parameter # F1h 6Eh

The check digit is the last character of the symbol used to verify the integrity of the data. Scan the appropriate bar code below to transmit the bar code data with or without the Matrix 2 of 5 check digit.

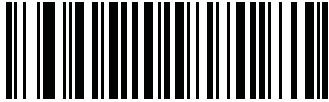

**Enable Matrix 2 of 5 Check Digit  
(01h)**



**\*Disable Matrix 2 of 5 Check Digit  
(00h)**

## Transmit Matrix 2 of 5 Check Digit

### Parameter # F1h 6Fh

Scan a bar code below to transmit Matrix 2 of 5 data with or without the check digit.



**Transmit Matrix 2 of 5 Check Digit  
(01h)**



**\*Do Not Transmit Matrix 2 of 5 Check Digit  
(00h)**



---

## Chinese 2 of 5

### Enable/Disable Chinese 2 of 5

#### Parameter # F0h 98h

To enable or disable Chinese 2 of 5, scan the appropriate bar code below.



Enable Chinese 2 of 5  
(01h)



\*Disable Chinese 2 of 5  
(00h)

---

## Korean 3 of 5

### Enable/Disable Korean 3 of 5

#### Parameter # F1h 45h

To enable or disable Korean 3 of 5, scan the appropriate bar code below.



**NOTE** The length for Korean 3 of 5 is fixed at 6.



Enable Korean 3 of 5  
(01h)



\*Disable Korean 3 of 5  
(00h)

---

## Inverse 1D

### Parameter # F1h 4Ah

This parameter sets the 1D inverse decoder setting. Options are:

- **Regular Only** - the digital scanner decodes regular 1D bar codes only.
- **Inverse Only** - the digital scanner decodes inverse 1D bar codes only.
- **Inverse Autodetect** - the digital scanner decodes both regular and inverse 1D bar codes.



\*Regular  
(00h)



Inverse Only  
(01h)



Inverse Autodetect  
(02h)

---

## Postal Codes

### US Postnet

#### Parameter # 59h

To enable or disable US Postnet, scan the appropriate bar code below.



Enable US Postnet  
(01h)



\*Disable US Postnet  
(00h)

### US Planet

#### Parameter # 5Ah

To enable or disable US Planet, scan the appropriate bar code below.



Enable US Planet  
(01h)



\*Disable US Planet  
(00h)

## Transmit US Postal Check Digit

### Parameter # 5Fh

Select whether to transmit US Postal data, which includes both US Postnet and US Planet, with or without the check digit.

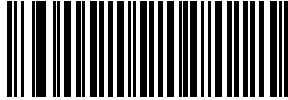

\*Transmit US Postal Check Digit  
(01h)

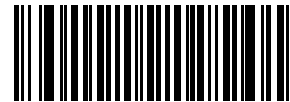

Do Not Transmit US Postal Check Digit  
(00h)

## UK Postal

### Parameter # 5Bh

To enable or disable UK Postal, scan the appropriate bar code below.



Enable UK Postal  
(01h)

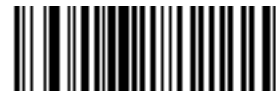

\*Disable UK Postal  
(00h)

## Transmit UK Postal Check Digit

### Parameter # 60h

Select whether to transmit UK Postal data with or without the check digit.



\*Transmit UK Postal  
Check Digit  
(01h)



Do Not Transmit UK Postal Check Digit  
(00h)

## Japan Postal

### Parameter # F0h, 22h

To enable or disable Japan Postal, scan the appropriate bar code below.



Enable Japan Postal  
(01h)



\*Disable Japan Postal  
(00h)

## Australian Postal

### Parameter # F0h, 23h

To enable or disable Australian Postal, scan the appropriate bar code below.



**Enable Australian Postal  
(01h)**



**\*Disable Australian Postal  
(00h)**

## Australia Post Format

### Parameter # F1h CEh

To select one of the following formats for Australia Post, scan the appropriate bar code below:

- **Autodiscriminate** (or Smart mode) - Attempt to decode the Customer Information Field using the N and C Encoding Tables.

✓ **NOTE** This option increases the risk of misdecodes because the encoded data format does not specify the Encoding Table used for encoding.

- **Raw Format** - Output raw bar patterns as a series of numbers 0 through 3.
- **Alphanumeric Encoding** - Decode the Customer Information Field using the C Encoding Table.
- **Numeric Encoding** - Decode the Customer Information Field using the N Encoding Table.

For more information on Australia Post Encoding Tables, refer to the *Australia Post Customer Barcoding Technical Specifications* available at <http://www.auspost.com.au>.



\*Autodiscriminate  
(00h)



Raw Format  
(01h)



Alphanumeric Encoding  
(02h)



Numeric Encoding  
(03h)

## Netherlands KIX Code

### Parameter # F0h, 46h

To enable or disable Netherlands KIX Code, scan the appropriate bar code below.



Enable Netherlands KIX Code  
(01h)



\*Disable Netherlands KIX Code  
(00h)

## USPS 4CB/One Code/Intelligent Mail

### Parameter # F1h 50h

To enable or disable USPS 4CB/One Code/Intelligent Mail, scan the appropriate bar code below.



Enable USPS 4CB/One Code/Intelligent Mail  
(01h)



\*Disable USPS 4CB/One Code/Intelligent Mail  
(00h)



## UPU FICS Postal

### Parameter # F1h 63h

To enable or disable UPU FICS Postal, scan the appropriate bar code below.



**Enable UPU FICS Postal  
(01h)**



**\*Disable UPU FICS Postal  
(00h)**

## GS1 DataBar

The variants of GS1 DataBar are DataBar-14, DataBar Expanded, and DataBar Limited. The limited and expanded versions have stacked variants. Scan the appropriate bar codes to enable or disable each variant of GS1 DataBar.

### GS1 DataBar-14

**Parameter # F0h 52h.**

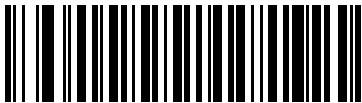

Enable GS1 DataBar-14  
(01h)

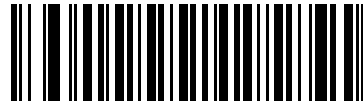

\*Disable GS1 DataBar 14  
(00h)

### GS1 DataBar Limited

**Parameter # F0h 53h.**

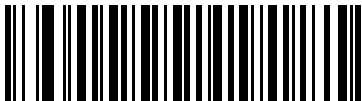

Enable GS1 DataBar Limited  
(01h)

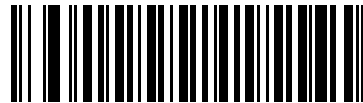

\*Disable GS1 DataBar Limited  
(00h)

## GS1 DataBar Expanded

### Parameter # F0h 54h.

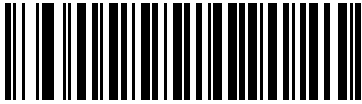

Enable GS1 DataBar Expanded  
(01h)

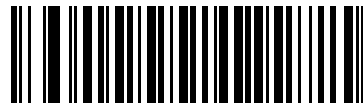

\*Disable GS1 DataBar Expanded  
(00h)

## Convert GS1 DataBar to UPC/EAN

### Parameter # F0h, 8Dh

This parameter only applies to GS1 DataBar-14 and GS1 DataBar Limited symbols not decoded as part of a Composite symbol. Enable this to strip the leading '010' from DataBar-14 and DataBar Limited symbols encoding a single zero as the first digit, and report the bar code as EAN-13.

For bar codes beginning with two or more zeros but not six zeros, this parameter strips the leading '0100' and reports the bar code as UPC-A. The UPC-A Preamble parameter that transmits the system character and country code applies to converted bar codes. Note that neither the system character nor the check digit can be stripped.



Enable Convert GS1 DataBar to UPC/EAN  
(01h)

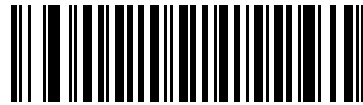

\*Disable Convert GS1 DataBar to UPC/EAN  
(00h)

## GS1 DataBar Limited Security Level

### Parameter # F1h D8h

The digital scanner offers four levels of decode security for GS1 DataBar Limited bar codes. There is an inverse relationship between security and digital scanner aggressiveness. Increasing the level of security may result in reduced aggressiveness in scanning, so only choose the level of security necessary.

- Level 1 – No clear margin required. This complies with the original GS1 standard, yet might result in erroneous<sup>1</sup> decoding of the DataBar Limited bar code when scanning some UPC symbols that start with the digits “9” and “7”.
- Level 2 – Automatic risk detection. This level of security may result in erroneous decoding of DataBar Limited bar codes when scanning some UPC symbols. If a misdecode is detected, the scanner operates in Level 3 or Level 1.
- Level 3 – Security level reflects newly proposed GS1 standard that requires a 5X trailing clear margin.
- Level 4 – Security level extends beyond the standard required by GS1. This level of security requires a 5X leading and trailing clear margin.



Security Level 1  
(01h)

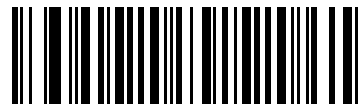

Security Level 2  
(02h)



\*Security Level 3  
(03h)



Security Level 4  
(04h)

---

1. May result in erroneous decoding due to Databar Limited and UPC symbologies.

---

## Composite

### Composite CC-C

#### Parameter # F0h 55h

Scan a bar code below to enable or disable Composite bar codes of type CC-C.



Enable CC-C  
(01h)



\*Disable CC-C  
(00h)

### Composite CC-A/B

#### Parameter # F0h 56h

Scan a bar code below to enable or disable Composite bar codes of type CC-A/B.



Enable CC-A/B  
(01h)



\*Disable CC-A/B  
(00h)

## Composite TLC-39

### Parameter # F0h 73h

Scan a bar code below to enable or disable Composite bar codes of type TLC-39.

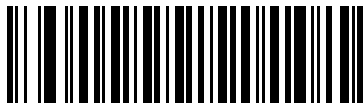

Enable TLC39  
(01h)



\*Disable TLC39  
(00h)

## UPC Composite Mode

### Parameter # F0h 58h

Select an option for linking UPC symbols with a 2D symbol during transmission as if they were one symbol:

- Select **UPC Never Linked** to transmit UPC bar codes regardless of whether a 2D symbol is detected.
- Select **UPC Always Linked** to transmit UPC bar codes and the 2D portion. If 2D is not present, the UPC bar code does not transmit.
- If you select **Autodiscriminate UPC Composites**, the device determines if there is a 2D portion, then transmits the UPC, as well as the 2D portion if present.



\*UPC Never Linked  
(00h)



UPC Always Linked  
(01h)



Autodiscriminate UPC Composites  
(02h)

## Composite Beep Mode

### Parameter # F0h 8Eh

To select the number of decode beeps when a composite bar code is decoded, scan the appropriate bar code.

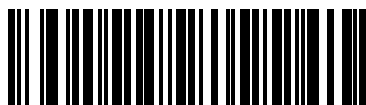

Single Beep After Both are Decoded  
(00h)



\*Beep as Each Code Type is Decoded  
(01h)

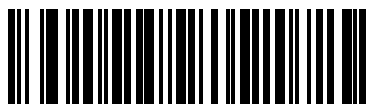

Double Beep After Both are Decoded  
(02h)

---

## 2D Symbologies

### Enable/Disable PDF417

#### Parameter # 0Fh

To enable or disable PDF417, scan the appropriate bar code below.



\*Enable PDF417  
(01h)



Disable PDF417  
(00h)

## **Enable/Disable MicroPDF417**

### **Parameter # E3h**

To enable or disable MicroPDF417, scan the appropriate bar code below.



**Enable MicroPDF417  
(01h)**



**\*Disable MicroPDF417  
(00h)**



## Code 128 Emulation

### Parameter # 7Bh

Enable this parameter to transmit data from certain MicroPDF417 symbols as Code 128. *AIM Code ID Character (01h) on page 5-23* must be enabled for this parameter to work.

Enable Code 128 Emulation to transmit these MicroPDF417 symbols with one of the following prefixes:

- ]C1 if the first codeword is 903-905
- ]C2 if the first codeword is 908 or 909
- ]C0 if the first codeword is 910 or 911

Disable Code 128 Emulation to transmit these MicroPDF417 symbols with one of the following prefixes:

- ]L3 if the first codeword is 903-905
- ]L4 if the first codeword is 908 or 909
- ]L5 if the first codeword is 910 or 911

Scan a bar code below to enable or disable Code 128 Emulation.



**NOTE** Linked MicroPDF codewords 906, 907, 912, 914, and 915 are not supported. Use GS1 Composites instead.



**Enable Code 128 Emulation  
(01h)**



**\*Disable Code 128 Emulation  
(00h)**

## Data Matrix

### Parameter # F0h, 24h

To enable or disable Data Matrix, scan the appropriate bar code below.



**\*Enable Data Matrix  
(01h)**



**Disable Data Matrix  
(00h)**

## Maxicode

### Parameter # F0h, 26h

To enable or disable Maxicode, scan the appropriate bar code below.



**\*Enable Maxicode  
(01h)**



**Disable Maxicode  
(00h)**

## QR Code

### Parameter # F0h,25h

To enable or disable QR Code, scan the appropriate bar code below.



\*Enable QR Code  
(01h)



Disable QR Code  
(00h)

## MicroQR

### Parameter # F1h 3Dh

To enable or disable MicroQR, scan the appropriate bar code below.



\*Enable MicroQR  
(01h)



Disable MicroQR  
(00h)

## Aztec

### Parameter # F1h 3Eh

To enable or disable Aztec, scan the appropriate bar code below.



\*Enable Aztec  
(01h)



Disable Aztec  
(00h)

## Redundancy Level

### Parameter # 4Eh

The device offers four levels of decode redundancy. Select higher redundancy levels for decreasing levels of bar code quality. As redundancy levels increase, the device's aggressiveness decreases.

Select the redundancy level appropriate for the bar code quality.

### Redundancy Level 1

The following code types must be successfully read twice before being decoded:

**Table 12-2** *Redundancy Level 1 Codes*

Code Type	Code Length
Codabar	or less
MSI	4 characters or less
D 2 of 5	8 characters or less
I 2 of 5	8 characters or less

### Redundancy Level 2

The following code types must be successfully read twice before being decoded:

**Table 12-3** *Redundancy Level 2 Codes*

Code Type	Code Length
All	All

### Redundancy Level 3

Code types other than the following must be successfully read twice before being decoded. The following codes must be read three times:

**Table 12-4** *Redundancy Level 3 Codes*

Code Type	Code Length
MSI	4 characters or less
D 2 of 5	8 characters or less
I 2 of 5	8 characters or less
Codabar	8 characters or less

## Redundancy Level 4

The following code types must be successfully read three times before being decoded:

**Table 12-5** *Redundancy Level 4 Codes*

Code Type	Code Length
All	All

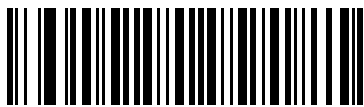

\*Redundancy Level 1  
(01h)

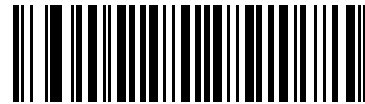

Redundancy Level 2  
(02h)

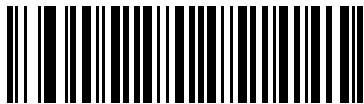

Redundancy Level 3  
(03h)

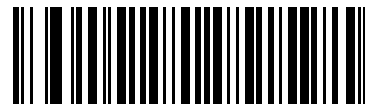

Redundancy Level 4  
(04h)

---

## Security Level

### Parameter # 4Dh

The device offers four levels of decode security for delta bar codes, which include the Code 128 family, UPC/EAN, and Code 93. Select increasing levels of security for decreasing levels of bar code quality. There is an inverse relationship between security and device aggressiveness, so choose only that level of security necessary for any given application.

- **Security Level 0:** This setting allows the device to operate in its most aggressive state, while providing sufficient security in decoding most “in-spec” bar codes.
- **Security Level 1:** This default setting eliminates most misdecodes.
- **Security Level 2:** Select this option if Security level 1 fails to eliminate misdecodes.
- **Security Level 3:** If you selected Security Level 2 and misdecodes still occur, select this security level. Be advised, selecting this option is an extreme measure against mis-decoding severely out of spec bar codes. Selecting this level of security significantly impairs the decoding ability of the device. If you need this level of security, try to improve the quality of the bar codes.

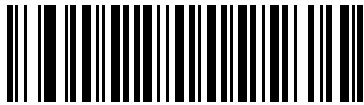

\*Security Level 0  
(00h)



Security Level 1  
(01h)

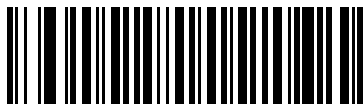

Security Level 2  
(02h)



Security Level 3  
(03h)

## Report Version

Scan the bar code below to report the version of software installed in the device.



**Report Software Version**



# Chapter 13 Accessories

## Introduction

The MT2070/MT2090 accessories provide a variety of product support capabilities. This chapter provides information about cables, single slot cradles, multi-slot cradles and the four slot battery charger.

**Table 13-1** *Accessories*

Accessory	Description
<b>Cradles</b>	
Single slot charge only cradle	STB2000-C10007R single slot charge only with ActiveSync cradle charges the device's Li-ion battery installed in the device. It also synchronizes the device with a host computer using ActiveSync through a USB connection. <b>Note:</b> If connecting ActiveSync via USB, it is recommended you use an ESD dongle with the USB cable. (ESD part numbers KT-8830-03R -3 piece kit, or KT-8830-10R - 10 piece kit.)
Single slot charge/multi-interface Bluetooth cradle	STB2078-C10007WR single slot multi-interface Bluetooth cradle charges the device's Li-ion battery installed in the device and, when the pairing bar code on the cradle is scanned, it pairs with the device allowing the device and cradle to exchange information. Note: ActiveSync is not supported on this cradle.
Single slot forklift cradle.	STB2000-F10007R forklift single slot charge only cradle charges the device's Li-ion battery installed in the device. The following accessories are not included but maybe required: Power Supply: Use ONLY a LISTED Type no. 50-14000 (9Vdc / 2Amax), or PWRS-14000 (9Vdc / 2Amax), Direct Plug-In Power supply, marked Class 2 or LPS (IEC60950-1, SELV). Use of alternative Power Supply will invalidate any approvals given to this unit and may be dangerous: three 1.25" #8 Phillips head screws (for wall mounting, if applicable, not available from Zebra).
Four slot charge only cradle	STB2000-C40007R four slot charge only cradle charges up to four spare batteries and up to four devices with batteries installed.

**Table 13-1** *Accessories (Continued)*

Accessory	Description
Four slot charge/Ethernet cradle	STB2000-C40017R four slot Ethernet cradle charges up to four spare batteries and up to four devices with batteries installed. It also synchronizes up to four devices with a host computer through an Ethernet connection. An Ethernet cable is required for communication (not available from Zebra).
<b>Battery Charger</b>	
Four slot spare battery charger	SAC2000-4000CR four slot spare battery charger charges up to four single batteries.
<b>Cables</b>	
USB Client Charge Cable	Cable attaches from device/cradle to host PC.
RS-232 Serial Cable with Power Supply.	Cable attaches from device/cradle to host PC.
<b>Miscellaneous</b>	
IntelliStand	The IntelliStand provides a hands-free method of scanning.
Lanyard	Wrist strap.
Forklift mount bracket	The mounting bracket is used to install the STB2000-F cradle on a forklift.
Belt Holster	Device can be carried on a belt.

---

## Maintenance

See [Cradles on page 15-2](#).

---

## Batteries

Use only Zebra-branded batteries and chargers.

See [Battery Charging on page 1-14](#) and [Battery Safety on page 1-15](#) for detailed battery information.

---

## Mounting

The cradle can be mounted on a desktop or on a wall. Refer to the *Integrator Guide* for mounting instructions. Replace the desk mount cup with the wall (vertical) mount cup:

## Single Slot Cradles

The STB2000-C10007R, STB2078-C10007WR and STB2000-F10007R cordless device cradles act as chargers and host communication interfaces for the MT2000 Series cordless devices. Cradles can sit on a desktop, mount on a wall or mount on a forklift (STB2000-F only). Any discussion of transmission of information refers specifically to cradles with Bluetooth technology.

- ✓ **NOTE** Use ONLY a LISTED, Type no. 50-14000 (5-14Vdc/ 1.5A min.), or PWRS-14000 (5-14Vdc/ 1.5A min.), Direct Plug-In Power supply, marked Class 2 or LPS (IEC60950-1, SELV). Use of alternative Power Supply will invalidate any approvals given to this unit and may be dangerous.

Verwenden Sie NUR ein von Zebra GELISTETES, mit der Typnummer 50-14000 (5-14 VDC/mindestens 1,5 A) oder PWRS-14000 (5-14 VDC/mindestens 1,5 A) markiertes, Direct Plug-In-Netzteil, das als Klasse 2 oder LPS (IEC60950-1, SELV) gekennzeichnet ist. Bei Verwendung eines anderen Netzteils werden alle für das Gerät gewährten Genehmigungen außer Kraft gesetzt, und der Betrieb kann gefährlich sein.

### Cradle Features

See [Cradle Features on page 1-4](#).

### Battery Charging in the Cradle

Single slot cradles act as power pass throughs to the device allowing the device to charge the Li-ion battery in the device. A complete charge of a fully discharged battery can take up to four hours using external power and up to 10 hours using the interface cable.

- ✓ **NOTE** To charge the battery for your device, battery and charger temperatures must be between +32° F and +104° F (0° C to +40° C).

To charge the device:

1. Connect the single slot USB cradle to a power source.
2. Insert the battery into the battery slot in the device noting the battery polarity.
3. Insert the top of the device into the cradle first, then firmly press the device into place. The device's green charge LED indicates the device battery charging status.
4. When charging is completed, the green LED is off (default) and the device can be lifted out of the cradle.

- ✓ **NOTE** If the battery is completely discharged, and the unit is powered from a USB or RS232 cable, it may take up to two hours for the unit to power up. There is no indication to the user of this condition and it may appear that the unit is not charging and/or not working correctly. However, if the unit is placed in an STB2000 or STB2078 cradle with the 12V power supply power up is immediate.

- ✓ **NOTE** The default state of the LED is off when the battery is fully charged with the exception of several initial charge cycles. The LED may continually blink until the battery goes through several discharge cycles to calibrate itself.

### Changing the Host Interface

To connect to a different host, or to the same host using a different cable:

1. Disconnect the power supply from the cradle, if applicable.
2. Disconnect the interface cable from the host.

3. Connect the interface cable to the new host, or the new interface cable to the existing host.
4. Reconnect the power supply, if required.
5. If necessary, scan the appropriate host bar code (for non-autodetected interfaces).



**CAUTION** If the device does not recognize the host, disconnect the power supply, then reconnect after connecting the host cable.

## Communication

### Sending Data to the Host Computer

The STB2078-C10007WR single slot multi-interface Bluetooth cradle receives data from the device via a wireless radio connection and transmits it to the host computer via the host cable. The device and cradle must be paired for successful wireless communication. For detailed information about pairing, radio communications, Bluetooth technology and lost connections to the host computer, refer to the *MT2070/MT2090 Integrator Guide* (part number 72E-117858-xx).



**NOTE** ActiveSync is not supported on this cradle.

## LED Indicators

**Table 13-2** LED Charging Status Indicators - Single Slot Charge Only Cradles

LED	Indication
<b>LED on Device</b>	
Off	No power applied to device (battery discharged or removed); device is in low power and ready to scan; or, battery is fully charged and device is ready to scan. <b>Note:</b> The default state of the LED is off when the battery is fully charged. By modifying the BatteryLED.reg file under the \Platform directory on the device, you have the option to enable a solid green LED on a fully charged battery. For detailed information, refer to the MT2070/MT2090 Integrator Guide, p/n 72E-117858-xx.
Green Flash	Device is charging (when cradle is powered from external power supply).
Red Flash	Charging problem or data transmission problem.
<b>LED on Cradle</b>	
Off	Cradle is not powered or power fault on contacts.
Solid Blue	Cradle is powered.

**Table 13-3** LED Charging Status Indicators - Single Slot Multi-interface Cradles

LED	Indication
<b>LED on Device</b>	
Off	No power applied to device (battery discharged or removed); device is in low power and ready to scan; or, battery is fully charged and device is ready to scan. <b>Note:</b> The default state of the LED is off when the battery is fully charged. By modifying the BatteryLED.reg file under the \Platform directory on the device, you have the option to enable a solid green LED on a fully charged battery. For detailed information, refer to the MT2070/MT2090 Integrator Guide, p/n 72E-117858-xx.
Green Flash	Device is charging (when cradle is powered from external power supply).
Red Flash	Charging problem or data transmission problem.
<b>LED on Cradle</b>	
Off	Cradle is not powered.
Solid Blue	Cradle is powered.
Red/Blue/Purple	Power up sequence.
Rapid Red/Blue/Red/Blue	Power fault on all contacts.

### Miscellaneous LED Indicator Information

- Single slot charge only cradle (STB2000)
  - Blue LED is off when there is a USB connection but no external power supply is used.
- Single slot multi-interface Bluetooth cradle (STB2078)
  - Blue LED lights when there is a USB or keyboard wedge connection but no external power supply is used.

## Four Slot Cradles

The STB2000-C40007R four slot charge only and STB2000-C40017R four slot Ethernet cradle act as chargers and host communication interfaces for the MT2000 Series cordless devices and batteries. Cradles can sit on a desktop or be mounted on a wall. This document provides basic instructions for cradle set up and use. Unless otherwise noted, *cradle* refers to both configurations of the cradle. Any discussion of transmission of information refers specifically to the STB2000-C40017R four slot Ethernet cradle.

Only use Zebra battery pack P/N 82-108066-01, rated 3.7V 2400mAh 8.88 Wh.

### Cradle Features

See [Cradle Features on page 1-4](#).

### Inserting Devices and Batteries in the Cradle

When inserting the device in the cradle, insert the device top first. Push the handle until it clicks into place, engaging the contacts in the cradle and device.

When inserting batteries in the cradle, align the connectors on the bottom of the battery with the battery charging connectors in the cradle. Push down on the top of the battery until it clicks into place, engaging the contacts in the cradle.

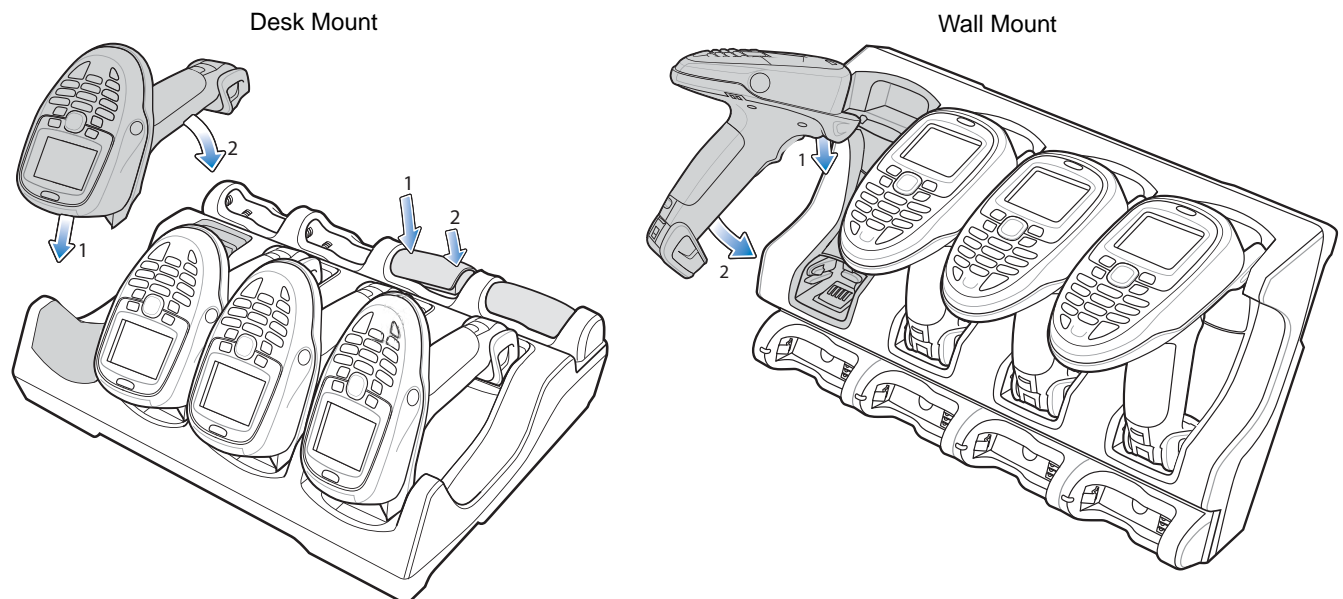

**Figure 13-1** Insert Device in Desk/Wall Mount Cradles

- ✓ **NOTE** When inserting the device in a wall mounted cradle, ensure the device's hook recesses engage the hooks on the wall mount adapter.

### Removing the Device from the Four Slot Cradle

To remove the scanner from a vertically mounted cradle, remove the bottom of the scanner first then gently pull the top of the scanner out of the cradle.

## Sending Data to the Host Computer

MT2000 Series include Ethernet cradle drivers that initiate automatically when you place the device in a properly connected four slot Ethernet cradle. The cradle receives data from the device and transmits it to the host computer via the Ethernet cable.

Prior to inserting the device in the cradle, it is recommended that you turn off the device's wi-fi radio to avoid interference. To turn off the radio, go to the *Home* screen on the device and select *Config > Wireless Companion > Disable Radio*.

## Charging

To charge the battery in the device and/or a spare battery, ensure the correct power supply is connected then place the device/battery in the cradle (see [Inserting Batteries on page 13-8](#)). Charging begins when the LED indicators, on the device and in the cradle's spare battery section, start flashing green. A complete charge of a fully discharged battery can take up to four hours.

## LED Indicators

**Table 13-4** Device LED Indicators

LED	Indication
Off	No power applied to device (battery discharged or removed); device is in low power and ready to scan; or, battery is fully charged and device is ready to scan. <b>Note:</b> The default state of the LED is off when the battery is fully charged. By modifying the BatteryLED.reg file under the \Platform directory on the device, you have the option to enable a solid green LED on a fully charged battery. For detailed information, refer to the MT2070/MT2090 Integrator Guide, p/n 72E-117858-xx.
Green Flash	Device is charging.
Red Flash	Charging problem or data transmission problem.

**Table 13-5** Cradle LED Indicators

LED	Indication
Solid Blue (Cradle Power LED)	Cradle is powered.
Ethernet Activity LEDs (Ethernet cradles only)	Speed LED (100/10) - Primary Port Connection The cradle's green Speed LED lights to indicate that the transfer rate is 100 Mbps. When it is not lit it indicates that the transfer rate is 10Mbps.
	Link LED (↔) - Primary Port Connection The cradle's amber Link LED blinks to indicate activity, or stays lit to indicate that a link is established. When it is not lit it indicates there is no link.

---

## Four Slot Battery Charger

The SAC2000-4000CR four slot spare battery charger charges up to four single spare batteries. The cradle can sit on a desktop or be mounted on a wall. This document provides basic instructions for cradle set up and use.

For best performance, fully charge the device battery before using the device for the first time. To charge the device battery, insert the battery in the cradle. The battery begins charging when the LED indicator on the battery charger starts flashing green. A complete charge of a fully discharged battery can take up to four hours. Charge within the recommended temperature of 32° to 104° F (0° C to 40° C) nominal, 41° to 95° F (5° to 35° C) ideal.

Only use Zebra battery pack P/N 82-108066-01, rated 3.7V 2400mAh 8.88 Wh.

### Features

See [Cradle Features on page 1-4](#).

### Inserting Batteries

To insert batteries in the cradle, align the connectors on the bottom of the battery with the battery charging connectors in the cradle. Push down on the top of the battery until it clicks into place, engaging the contacts in the cradle.

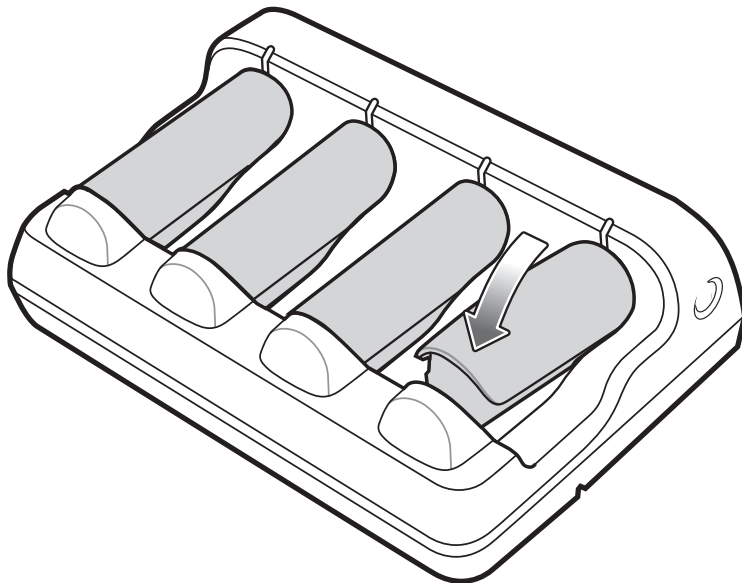

**Figure 13-2** *Inserting Batteries*

### Charging Batteries

The battery begins charging when the green LED indicator flashes. A complete charge of a fully discharged battery can take up to four hours using external power.



## LED Indicators

**Table 13-6** *Four Slot Battery Charger LEDs*

LED	Indication
Flashing Green Battery LED	Flashes when battery charges.
Solid Green Battery LED	Battery is fully charged.
Solid Blue Cradle LED	Lights when power is applied; off when there is no power applied.
Fast Green Flash	Error condition.

---

## Troubleshooting

For detailed cradle and battery charger information see [Chapter 15, Maintenance and Troubleshooting](#).

# Chapter 14 Advanced Data Formatting

---

## Introduction

Advanced Data Formatting (ADF) is a means of customizing data before transmission to the host device. Use ADF to edit scan data to suit particular requirements.

To implement ADF, scan a related series of bar codes, which begin on [page 14-8](#).

Avoid using ADF formatting with bar codes containing more than 60 characters. To add a prefix or suffix value for such bar codes, use [Prefix/Suffix Values on page 5-24](#). Using ADF with longer bar codes transmits the bar code in segments of length 252 or less (depending on the host selected), and applies the rule to each segment

---

## Rules: Criteria Linked to Actions

ADF uses **rules** to customize data. These rules perform detailed actions when the data meets certain criteria. One rule may consist of single or multiple criteria applied to single or multiple actions.

For instance, a data formatting rule could be:

**Criteria:** *When scan data is Code 39, length 12, and data at the start position is the string "129",*  
**Actions:** *pad all sends with zeros to length 8,  
send all data up to X,  
send a space.*

Scanning a Code 39 bar code of 1299X1559828 transmits the following: 00001299<space>. If you scan a Code 39 bar code of 1299X15598, this rule is ignored because the bar code did not meet the length criteria.

The rule specifies the editing conditions and requirements before data transmission occurs.

---

## Using ADF Bar Codes

When programming a rule, make sure the rule is logically correct. Plan ahead before scanning.

To program each data formatting rule:

- **Start the Rule.** Scan the [Begin New Rule bar code on page 14-8](#).
- **Specify Criteria.** Scan the bar codes for all pertinent criteria. Criteria can include code type (e.g., Code 128), code length, or data that contains a specific character string (e.g., the digits “129”). See [Criteria on page 14-11](#).
- **Select Actions.** Scan all actions related to, or affecting, these criteria. The actions of a rule specify how to format the data for transmission. See [Actions on page 14-27](#).
- **Save the Rule.** Scan the [Save Rule bar code on page 14-9](#). This places the rule in the “top” position in the rule buffer.
- To correct any errors, see [Erase on page 14-9](#) to erase criteria, actions, and entire rules.

[.Beeper Definitions on page 3-1](#) guide through the programming steps.

---

## ADF Bar Code Menu Example

This section provides an example of how to enter and use ADF rules for scan data.

An auto parts distribution center wants to encode manufacturer ID, part number, and destination code into their own Code 128 bar codes. The distribution center also has products that carry UPC bar codes, placed there by the manufacturer. The Code 128 bar codes have the following format:

MMMMMPPPPDD

Where:     M = Manufacturer ID  
           P = Part Number  
           D = Destination Code

The distribution center uses a PC with dedicated control characters for manufacturer ID <CTRL M>, part number <CTRL P>, and destination code <CTRL D>. At this center the UPC data is treated as manufacturer ID code.

The following rules must be entered:

When scanning data of code type Code 128, send the next 5 characters, send the manufacturer ID key <CTRL M>, send the next 5 characters, send the part number key <CTRL P>, send the next 2 characters, send the destination code key <CTRL D>.

When scanning data of code type UPC/EAN, send all data, send the manufacturer ID key <CTRL M>.

To enter these rules, see the following steps.

## Rule 1: The Code 128 Scanning Rule

Step	Bar Code	On Page	Beep Indication
1	Begin New Rule	<a href="#">14-8</a>	High High
2	Code 128	<a href="#">14-11</a>	High High
3	Send next 5 characters	<a href="#">14-28</a>	High High
4	Send <CTRL M>	<a href="#">14-49</a>	High High
5	Send next 5 characters	<a href="#">14-28</a>	High High
6	Send <CTRL P>	<a href="#">14-49</a>	High High
7	Send next 2 characters	<a href="#">14-27</a>	High High
8	Send <CTRL D>	<a href="#">14-48</a>	High High
9	Save Rule	<a href="#">14-9</a>	High Low High Low

## Rule 2: The UPC Scanning Rule

Step	Bar Code	On Page	Beep Indication
1	Begin New Rule	<a href="#">14-8</a>	High High
2	UPC/EAN	<a href="#">14-13</a>	High High
3	Send all remaining data	<a href="#">14-27</a>	High High
4	Send <CTRL M>	<a href="#">14-49</a>	High High
5	Save Rule	<a href="#">14-9</a>	High Low High Low

If you make an error while entering this rule, scan the [Quit Entering Rules bar code on page 14-9](#). If you already saved the rule, scan the [Erase Previously Saved Rule bar code on page 14-9](#).

## Alternate Rule Sets

You can group ADF rules into one of four alternate sets which you can turn on and off when needed. This is useful to format the same message in different ways. For example, a Code 128 bar code contains the following information:

Class (2 digits), Stock Number (8) digits, Price (5 digits)

The bar code might look like this:

245671243701500

where:

Class = 24

Stock Number = 56712437

Price = 01500

Ordinarily, data transmits as follows:

24 (class key)

56712437 (stock key)

01500 (enter key)

But, when there is a sale, send only the following:

24 (class key)

56712437 (stock key)

and the cashier keys the price manually.

To implement this, first enter an ADF rule that applies to the normal situation, such as:

Scan Rule Belongs to Set 1. When scanning a bar code of length 15, send the next 2 characters, send the class key, send the next 8 characters, send the stock key, send the data that remains, send the Enter key.

The “sale” rule may look like this:

Scan Rule Belongs to Set 2. When scanning a bar code of length 15, send the next 2 characters, send the class key, send the next 8 characters, send the stock key.

To switch between the two sets of rules, program a “switching rule” that specifies the type of bar code to scan to switch between the rule sets. For example, in the case of the “sale” rule above, the rule programmer wants the cashier to scan the bar code “M” before a sale. To do this, enter the following rule:

When scanning a bar code of length 1 that begins with “M”, select rule set number 1.

Program another rule to switch back.

When scanning a bar code of length 1 that begins with “N”, turn off rule set number 1.

Or include the switching back to normal rules in the “sale” rule:

When scanning a bar code of length 15, send the next 2 characters, send the class key, send the next 8 characters, send the stock key, turn off rule set 1.

For optimal results, scan the [Disable All Rule Sets bar code on page 14-10](#) after programming a rule belonging to an alternate rule set.

In addition to enabling and disabling rule sets within the rules, enable or disable them by scanning the appropriate bar codes on [page 14-10](#).

## Rules Hierarchy (in Bar Codes)

The order of programming individual rules is important. Program the most general rule first.

All programmed rules are stored in a buffer. As they are programmed, they are stored at the “top” of a rules list. If you create three rules, the list is configured as follows:

Third Rule  
Second Rule  
First Rule

When you scan data, the rules list is checked from top to bottom to determine if the criteria matches (and therefore, if the actions occur). Input is modified into the data format specified by the first matching set of criteria it finds. Be sure to program the most general rule first.

For example, if the THIRD rule states:

When scanning a bar code of any length, send all data, then send the ENTER key.

and the SECOND rule states:

When scanning a Code 128 bar code of length 12, send the first four characters, then send the ENTER key, then send all remaining data.

and you scan a Code 128 bar code of length 12, the THIRD rule applies, and the SECOND rule appears to not function.

Note that using the standard data editing functions also creates ADF rules. Scan options are entered as ADF rules, and the hierarchy mentioned above also applies to them. For the device, this applies to prefix/suffix programming in the parameter [Scan Data Transmission Format on page 5-25](#).

These rules reside in the same “rule list” as ADF Rules, so the order you create them is also important.

## Default Rules

Every unit has a default rule to send all scan data. Units with custom software may have one or more default rules burned in. The rules hierarchy checks user programmable rules first, then the default rules. Disable default rules by entering the following general rule in the user programmable buffer:

When receiving scan data, send all data.

Since this rule always applies, ADF never applies the default rules.

---

## ADF Bar Codes

[Table 14-1](#) lists the bar codes available through ADF.

**Table 14-1** ADF Bar Codes

Parameter	Page Number
<i>Special Commands</i>	14-8
<i>Pause Duration</i>	14-8
<i>Begin New Rule</i>	14-8
<i>Save Rule</i>	14-9
<i>Erase</i>	14-9
<i>Quit Entering Rules</i>	14-9
<i>Disable Rule Set</i>	14-10
<i>Criteria</i>	14-11
<i>Code Types</i>	14-11
<i>Code Lengths</i>	14-18
<i>1 Character - 6 Characters</i>	14-18
<i>7 Characters - 13 Characters</i>	14-19
<i>14 Characters - 20 Characters</i>	14-20
<i>21 Characters - 27 Characters</i>	14-21
<i>28 Characters - 30 Characters</i>	14-22
<i>Specific String at Start</i>	14-22
<i>Specific String, Any Location</i>	14-23
<i>Any Message OK</i>	14-23

**Table 14-1** ADF Bar Codes (Continued)

Parameter	Page Number
<i>Numeric Keypad</i>	14-24
<i>Rule Belongs To Set</i>	14-26
<i>Actions</i>	14-27
<i>Send Data</i>	14-27
<i>Send Data Up To Character</i>	14-27
<i>Send Next Character</i>	14-27
<i>Send All Data That Remains</i>	14-27
<i>Send Next 2 Characters - Send Next 20 Characters</i>	14-27
<i>Move Cursor</i>	14-31
<i>Send Pause</i>	14-32
<i>Skip Ahead</i>	14-33
<i>Skip Back</i>	14-34
<i>Send Preset Value</i>	14-36
<i>Remove All Spaces</i>	14-37
<i>Crunch All Spaces</i>	14-37
<i>Stop Space Removal</i>	14-37
<i>Remove Leading Zeros</i>	14-37
<i>Stop Zero Removal</i>	14-37
<i>Pad Data with Spaces</i>	14-38
<i>Pad Data with Zeros</i>	14-42
<i>Beeps</i>	14-47
<i>Send Keystroke (Control Characters and Keyboard Characters)</i>	14-47
<i>Keyboard Characters</i>	14-52
<i>Send ALT Characters</i>	14-66
<i>Send Keypad Characters</i>	14-71
<i>Send Function Key</i>	14-76
<i>Send F1 Key - Send F24 Key</i>	14-76
<i>Send PF1 Key - Send PF30 Key</i>	14-79
<i>Send Right Control Key</i>	14-83



**Table 14-1** ADF Bar Codes (Continued)

Parameter	Page Number
<i>Send Graphic User Interface (GUI) Characters</i>	14-84
<i>Send GUI 0 - Send GUI 9</i>	14-84
<i>Send GUI A - Send GUI Z</i>	14-85
<i>Turn On/Off Rule Sets</i>	14-89
<i>Alphanumeric Keyboard</i>	14-91
<i>Space - ' </i>	14-91
<i>0 - 9</i>	14-95
<i>A - Z</i>	14-96
<i>Cancel</i>	14-100
<i>End of Message</i>	14-100
<i>a - z</i>	14-100
<i>{ - ~</i>	14-104

---

## Special Commands

### Pause Duration

Use this parameter, along with [Send Pause on page 14-32](#), to insert a pause in the data transmission. Set the pause by scanning a two-digit number (i.e., two bar codes) from [Appendix D, Numeric Bar Codes](#) in 0.1 second intervals. For example, scanning bar codes **0** and **1** inserts a 0.1 second pause; **0** and **5** inserts a 0.5 second delay. To correct an error or change a selection, scan [Cancel on page D-3](#).



Pause Duration

### Begin New Rule

Scan the bar code below to start entering a new rule



Begin New Rule

## Save Rule

Scan the bar code below to save the rule.



Save Rule

## Erase

Use these bar codes to erase criteria, actions, or rules.



Erase Criteria And Start Again



Erase Actions And Start Again



Erase Previously Saved Rule



Erase All Rules

## Quit Entering Rules

Scan the bar code below to quit entering rules.



Quit Entering Rules

## Disable Rule Set

Use these bar codes to disable rule sets.



**Disable Rule Set 1**



**Disable Rule Set 2**



**Disable Rule Set 3**



**Disable Rule Set 4**



**Disable All Rule Sets**

---

## Criteria

### Code Types

Scan the bar codes for all code to be affected by the rule. Scan the codes in succession, prior to selecting other criteria. *To select all code types, do not scan any code type.*



Code 39



Codabar



GS1 DataBar-14



GS1 DataBar Limited



GS1 DataBar Expanded



Code 128



D 2 OF 5

## Code Types (continued)



IATA 2 OF 5



I 2 OF 5



Code 93



UPC-A



UPC-E



EAN-8



EAN-13

### Code Types (continued)



MSI



GS1-128



UPC-E1



Bookland EAN



Trioptic Code 39

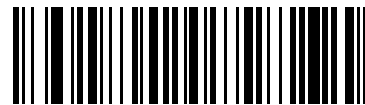

Code 11



Code 32

## Code Types (continued)



ISBT 128



Coupon Code



US Postnet



US Planet



UK Postal



Japan Postal



Australian Postal



### Code Types (continued)



Dutch Postal



4State Postal



Post US4



PDF417



MicroPDF



Macro PDF



Macro MicroPDF

## Code Types (continued)



Data Matrix



MaxiCode



QR Code



MicroQR



TLC 39



UPC/EAN Composites



GS1 DataBar and EAN128 Composites

**Code Types (continued)****Aztec****Aztec Rune**

**NOTE** When selecting composite bar codes, enable AIM IDs if parsing UPC or EAN composite data, or data from an application that uses symbol separators.

## Code Lengths

Scan these bar codes to define the number of characters the selected code type must contain. Select one length per rule only. *Do not select any code length to select code types of any length.*



**1 Character**



**2 Characters**



**3 Characters**



**4 Characters**



**5 Characters**



**6 Characters**

### Code Lengths (continued)



7 Characters



8 Characters



9 Characters



10 Characters



11 Characters



12 Characters



13 Characters

## Code Lengths (continued)



14 Characters



15 Characters



16 Characters



17 Characters

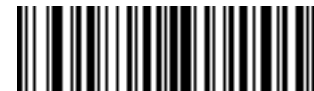

18 Characters



19 Characters



20 Characters

### Code Lengths (continued)



21 Characters



22 Characters



23 Characters



24 Characters



25 Characters



26 Characters



27 Characters

## Code Lengths (continued)



28 Characters



29 Characters



30 Characters

## Message Containing A Specific Data String

Use this feature to select whether the formatting affects data that begins with a specific character or data string, or contains a specific character or data string.

There are 5 features:

- Specific String at Start
- Specific String, Any Location
- Any Message OK
- Rule Belongs to Set

### Specific String at Start

1. Scan the following bar code.
2. Scan the bar codes representing the desired character or characters (up to a total of 8) using the [Alphanumeric Keyboard on page 14-91](#).
3. Scan [End of Message bar code on page 14-100](#).



Specific String At Start



**Specific String, Any Location**

1. Scan the following bar code.
2. Enter a location by scanning a two-digit number representing the **position** (use a leading "zero" if necessary) using the [Numeric Keypad on page 14-24](#).
3. Scan the bar codes representing the desired character or characters (up to a total of 8) using the [Alphanumeric Keyboard on page 14-91](#).
4. Scan [End of Message bar code on page 14-100](#).

**Specific String Any Location****Any Message OK**

Do not scan any bar code to format all selected code types, regardless of information contained.

## Numeric Keypad

Do not confuse bar codes on this page with those on the alphanumeric keyboard.



0



1



2



3



4



5



6

**Numeric Keypad (continued)**



7



8



9



Cancel

### Rule Belongs To Set

Select the set to which a rule belongs. There are four possible rule sets. See [Alternate Rule Sets on page 14-3](#) for more information about rule sets.



**Rule Belongs To Set 1**



**Rule Belongs To Set 2**



**Rule Belongs To Set 3**



**Rule Belongs To Set 4**

---

## Actions

Select how to format the data for transmission.

### Send Data

Send all data that follows, send all data up to a specific character selected from the [Alphanumeric Keyboard on page 14-91](#), or send the next *X* characters. Note that only bar codes for **Send Next 1 to 20** appear here, and can be scanned multiple times to send values greater than 20. For instance, to send the next 28 characters, scan **Send Next 20 Characters**, then **Send Next 8 Characters**.



Send Data Up To Character



Send All Data That Remains



Send Next Character



Send Next 2 Characters



Send Next 3 Characters



Send Next 4 Characters

## Send Data (continued)



**Send Next 5 Characters**



**Send Next 6 Characters**



**Send Next 7 Characters**



**Send Next 8 Characters**



**Send Next 9 Characters**



**Send Next 10 Characters**



**Send Next 11 Characters**

## Send Data (continued)



Send Next 12 Characters



Send Next 13 Characters



Send Next 14 Characters



Send Next 15 Characters



Send Next 16 Characters



Send Next 17 Characters



Send Next 18 Characters

## Send Data (continued)



Send Next 19 Characters



Send Next 20 Characters

## Setup Field(s)

Table 14-2 Setup Field(s) Definitions

Parameter	Description	Page Number
<b>Move Cursor</b>		
<b>Move Cursor To a Character</b>	Scan the <i>Move Cursor To Character</i> , then any printable ASCII character from the <i>Alphanumeric Keyboard on page 14-91</i> . This moves the cursor to the position after the matching character. If the character is not there, the rule fails and ADF tries the next rule.	14-31
<b>Move Cursor to Start of Data</b>	Scan this bar code to move cursor to the beginning of the data.	14-31
<b>Move Cursor Past a Character</b>	This action moves the cursor past all sequential occurrences of a selected character. For example, if the selected character is 'A', then the cursor moves past 'A', 'AA', 'AAA', etc. Scan the <i>Move Cursor Past Character</i> , then select a character from the <i>Alphanumeric Keyboard</i> . If the character is not there, the cursor does not move (i.e., has no effect).	14-31
<b>Move Cursor Past Specific String</b>	This action moves the cursor past the first occurrence of a selected string.	14-32
<b>Move Cursor to Specific String and Replace</b>	This action moves the cursor to the start of the first occurrence of a selected string and replaces that string with another user-defined string.	14-32
<b>Move Cursor to Last Occurrence of String and Replace All</b>	This action replaces all occurrences of a specific string with a user-defined string and moves the cursor to the beginning of the last such occurrence.	14-32
<b>Skip to End</b>	This action moves the cursor to the end of the bar code.	14-32



**Table 14-2** Setup Field(s) Definitions (Continued)

Parameter	Description	Page Number
<b>Skip Ahead “N” Characters</b>	Scan one of these bar codes to select the number of positions ahead to move the cursor.	14-33
<b>Skip Back “N” Characters</b>	Scan one of these bar codes to select the number of positions back to move the cursor.	14-34
<b>Send Preset Value</b>	Send Values 1 through 6 by scanning the appropriate bar code. Set these values using the prefix/suffix values in <a href="#">Table 8-4 on page 8-19</a> . Value 1 = Scan Suffix Value 2 = Scan Prefix Values 3-6 are not applicable	14-34

**Move Cursor**

Scan a bar code below to move the cursor in relation to a specified character. Then enter a character by scanning a bar code from the [Alphanumeric Keyboard on page 14-91](#).

✓ **NOTE** If there is no match and the rule fails, the next rule is checked.

**Move Cursor To Character****Move Cursor To Start****Move Cursor Past Character**

### Move Cursor (Continued)



Move Cursor Past Character

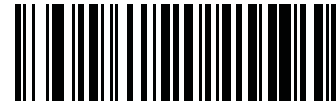

Move Cursor Past Specific String

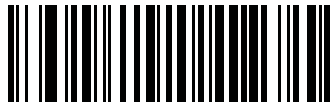

Move Cursor to Specific String and Replace



Move Cursor to Last Occurrence of String and Replace All

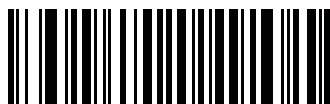

Skip to End

### Send Pause

Scan the bar code below to insert a pause in the transmission of data. See [Pause Duration on page 14-8](#) to set the length of this pause.



Send Pause

## Skip Ahead

Use the following bar codes to skip ahead characters.

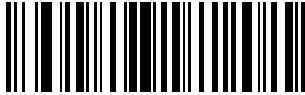

**Skip Ahead 1 Character**



**Skip Ahead 2 Characters**



**Skip Ahead 3 Characters**

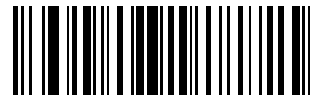

**Skip Ahead 4 Characters**



**Skip Ahead 5 Characters**

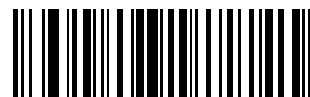

**Skip Ahead 6 Characters**



**Skip Ahead 7 Characters**

### Skip Ahead (continued)



**Skip Ahead 8 Characters**



**Skip Ahead 9 Characters**



**Skip Ahead 10 Characters**

### Skip Back

Use the following bar codes to skip back characters.



**Skip Back 1 Character**



**Skip Back 2 Characters**



**Skip Back 3 Characters**

**Skip Back (continued)**



**Skip Back 4 Characters**



**Skip Back 5 Characters**



**Skip Back 6 Characters**



**Skip Back 7 Characters**



**Skip Back 8 Characters**



**Skip Back 9 Characters**



**Skip Back 10 Characters**

### Send Preset Value

Use these bar codes to send preset values. See [Prefix/Suffix Values on page 5-24](#) to set these values.

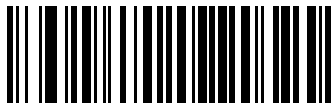

**Send Prefix**



**Send Suffix**

## Modify Data

Modify data as described below. The following actions work for all send commands that follow it within a rule. Programming *pad zeros to length 6, send next 3 characters, stop padding, send next 5 characters*, adds three zeros to the first send, and the next send is unaffected by the padding. These options do not apply to the **Send Keystroke** or **Send Preset Value** options.

### Remove All Spaces

To remove all spaces in the send commands that follow, scan the bar code below.



Remove All Spaces

### Crunch All Spaces

To leave one space between words, scan the bar code below. This also removes all leading and trailing spaces.



Crunch All Spaces

### Stop Space Removal

Scan the bar code below to disable space removal.



Stop Space Removal

### Remove Leading Zeros

Scan the bar code below to remove all leading zeros.



Remove Leading Zeros

### Stop Zero Removal

Scan the bar code below to disable the removal of zeros.



Stop Zero Removal

## Pad Data with Spaces

To pad data to the left, scan the bar code containing the desired number of spaces. Use **Send** commands to activate this parameter.



Pad Spaces To Length 1



Pad Spaces To Length 2



Pad Spaces To Length 3



Pad Spaces To Length 4



Pad Spaces To Length 5



Pad Spaces To Length 6



Pad Spaces To Length 7



### Pad Data with Spaces (continued)



Pad Spaces To Length 8



Pad Spaces To Length 9



Pad Spaces To Length 10



Pad Spaces To Length 11



Pad Spaces To Length 12



Pad Spaces To Length 13



Pad Spaces To Length 14

### Pad Data with Spaces (continued)



Pad Spaces To Length 15



Pad Spaces To Length 16



Pad Spaces To Length 17



Pad Spaces To Length 18



Pad Spaces To Length 19



Pad Spaces To Length 20



Pad Spaces To Length 21

### Pad Data with Spaces (continued)



Pad Spaces To Length 22



Pad Spaces To Length 23



Pad Spaces To Length 24



Pad Spaces To Length 25



Pad Spaces To Length 26



Pad Spaces To Length 27



Pad Spaces To Length 28

### Pad Data with Spaces (continued)



Pad Spaces To Length 29



Pad Spaces To Length 30



Stop Pad Spaces

### Pad Data with Zeros

To pad data to the left, scan the bar code containing the desired number of zeros. Use **Send** commands to activate this parameter.



Pad Zeros To Length 1



Pad Zeros To Length 2



Pad Zeros To Length 3

## Pad Data with Zeros (continued)



Pad Zeros To Length 4



Pad Zeros To Length 5



Pad Zeros To Length 6



Pad Zeros To Length 7



Pad Zeros To Length 8



Pad Zeros To Length 9



Pad Zeros To Length 10

### Pad Data with Zeros (continued)



Pad Zeros To Length 11



Pad Zeros To Length 12



Pad Zeros To Length 13



Pad Zeros To Length 14



Pad Zeros To Length 15



Pad Zeros To Length 16



Pad Zeros To Length 17

### Pad Data with Zeros (continued)



Pad Zeros To Length 18



Pad Zeros To Length 19



Pad Zeros To Length 20



Pad Zeros To Length 21



Pad Zeros To Length 22



Pad Zeros To Length 23



Pad Zeros To Length 24

### Pad Data with Zeros (continued)



Pad Zeros To Length 25



Pad Zeros To Length 26



Pad Zeros To Length 27



Pad Zeros To Length 28



Pad Zeros To Length 29



Pad Zeros To Length 30



Stop Pad Zeros



## Beeps

Select a beep sequence for each ADF rule.



Beep Once



Beep Twice



Beep Three Times

## Send Keystroke (Control Characters and Keyboard Characters)

### Control Characters

Scan a **Send** bar code for the keystroke to send.



Send Control 2



Send Control A



Send Control B

**Control Characters (continued)**



**Send Control C**



**Send Control D**



**Send Control E**



**Send Control F**



**Send Control G**



**Send Control H**



**Send Control I**

**Control Characters (continued)**



**Send Control J**



**Send Control K**



**Send Control L**



**Send Control M**



**Send Control N**



**Send Control O**



**Send Control P**

**Control Characters (continued)**



**Send Control Q**



**Send Control R**



**Send Control S**



**Send Control T**



**Send Control U**



**Send Control V**



**Send Control W**

**Control Characters (continued)**



**Send Control X**



**Send Control Y**



**Send Control Z**



**Send Control [**



**Send Control \**



**Send Control ]**

### Control Characters (continued)



Send Control 6



Send Control -

### Keyboard Characters

Scan a **Send** bar code for the keyboard characters to send.



Send Space



Send !



**Keyboard Characters (continued)**



**Send \$**



**Send %**



**Send &**



**Send '**



**Send (**



**Send )**



**Send \***

**Keyboard Characters (continued)**



**Send +**



**Send ,**



**Send -**



**Send .**



**Send /**



**Send 0**



**Send 1**



**Keyboard Characters (continued)**



**Send 2**



**Send 3**



**Send 4**



**Send 5**



**Send 6**



**Send 7**



**Send 8**

### Keyboard Characters (continued)



Send 9



Send :



Send ;



Send <



Send =



Send >



Send ?

**Keyboard Characters (continued)**



**Send @**



**Send A**



**Send B**



**Send C**



**Send D**



**Send E**



**Send F**

**Keyboard Characters (continued)**



**Send G**



**Send H**



**Send I**



**Send J**



**Send K**



**Send L**



**Send M**

**Keyboard Characters (continued)**



**Send N**



**Send O**



**Send P**



**Send Q**



**Send R**



**Send S**



**Send T**

**Keyboard Characters (continued)**



**Send U**



**Send V**



**Send W**



**Send X**



**Send Y**



**Send Z**



**Send [**

### Keyboard Characters (continued)



Send \



Send ]



Send ^



Send \_



Send `



Send a



Send b

**Keyboard Characters (continued)**



**Send c**



**Send d**



**Send e**



**Send f**



**Send g**



**Send h**



**Send i**



**Keyboard Characters (continued)**



**Send j**



**Send k**



**Send l**



**Send m**



**Send n**



**Send o**



**Send p**

**Keyboard Characters (continued)**



**Send q**



**Send r**



**Send s**



**Send t**



**Send u**



**Send v**



**Send w**

**Keyboard Characters (continued)**



**Send x**



**Send y**



**Send z**



**Send {**



**Send |**



**Send }**



**Send ~**

## Send ALT Characters



Send Alt 2



Send Alt A



Send Alt B



Send Alt C



Send Alt D



Send Alt E



Send Alt F

**Send ALT Characters (continued)**



**Send Alt G**



**Send Alt H**



**Send Alt I**



**Send Alt J**



**Send Alt K**



**Send Alt L**



**Send Alt M**

**Send ALT Characters (continued)**



**Send Alt N**



**Send Alt O**



**Send Alt P**



**Send Alt Q**



**Send Alt R**



**Send Alt S**



**Send Alt T**

**Send ALT Characters (continued)**



**Send Alt U**



**Send Alt V**



**Send Alt W**



**Send Alt X**



**Send Alt Y**



**Send Alt Z**

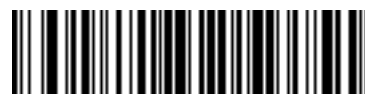

**Send Alt [**

**Send ALT Characters (continued)**



**Send Alt \**



**Send Alt ]**



## Send Keypad Characters



Send Keypad \*



Send Keypad +



Send Keypad -



Send Keypad .



Send Keypad /



Send Keypad 0



Send Keypad 1

**Send Keypad Characters (continued)**



**Send Keypad 2**



**Send Keypad 3**



**Send Keypad 4**



**Send Keypad 5**



**Send Keypad 6**



**Send Keypad 7**



**Send Keypad 8**

**Send Keypad Characters (continued)**



**Send Keypad 9**



**Send Keypad Enter**



**Send Keypad Numlock**



**Send Break Key**



**Send Delete Key**



**Send Page Up Key**



**Send End Key**

### Send Keypad Characters (continued)



Send Page Down Key



Send Pause Key



Send Scroll Lock Key



Send Backspace Key



Send Tab Key



Send Print Screen Key



Send Insert Key

**Send Keypad Characters (continued)**



**Send Home Key**



**Send Enter Key**



**Send Escape Key**



**Send Up Arrow Key**



**Send Down Arrow Key**



**Send Left Arrow Key**



**Send Right Arrow Key**

## Send Function Key



Send F1 Key



Send F2 Key



Send F3 Key



Send F4 Key



Send F5 Key



Send F6 Key



Send F7 Key

**Send Function Key (continued)**



**Send F8 Key**



**Send F9 Key**



**Send F10 Key**



**Send F11 Key**



**Send F12 Key**



**Send F13 Key**



**Send F14 Key**

**Send Function Key (continued)**



**Send F15 Key**



**Send F16 Key**



**Send F17 Key**



**Send F18 Key**



**Send F19 Key**



**Send F20 Key**



**Send F21 Key**



**Send Function Key (continued)**



**Send F22 Key**



**Send F23 Key**



**Send F24 Key**



**Send PF1 Key**



**Send PF2 Key**



**Send PF3 Key**



**Send PF4 Key**

**Send Function Key (continued)**



**Send PF5 Key**



**Send PF6 Key**



**Send PF7 Key**



**Send PF8 Key**



**Send PF9 Key**



**Send PF10 Key**



**Send PF11 Key**

**Send Function Key (continued)**



**Send PF12 Key**



**Send PF13 Key**



**Send PF14 Key**



**Send PF15 Key**



**Send PF16 Key**



**Send PF17 Key**



**Send PF18 Key**

**Send Function Key (continued)**



**Send PF19 Key**



**Send PF20 Key**



**Send PF21 Key**



**Send PF22 Key**



**Send PF23 Key**



**Send PF24 Key**



**Send PF25 Key**

## Send Function Key (continued)



Send PF26 Key



Send PF27 Key



Send PF28 Key



Send PF29 Key



Send PF30 Key

## Send Right Control Key

The **Send Right Control Key** action sends a tap (press and release) of the Right Control Key.



Send Right Control Key

## Send Graphic User Interface (GUI) Characters

The **Send Graphic User Interface Character** actions taps the specified key while holding the System Dependent Graphic User Interface (GUI) Key. The definition of the Graphic User Interface key depends on the attached system.

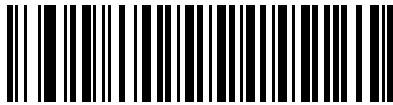

Send GUI 0

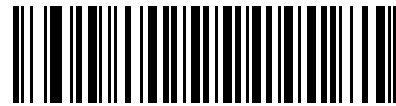

Send GUI 1



Send GUI 2



Send GUI 3



Send GUI 4

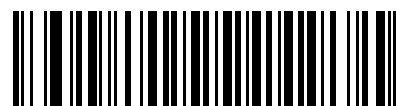

Send GUI 5

### Send Graphic User Interface (GUI) Characters (continued)

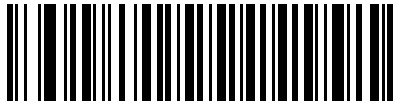

Send GUI 6

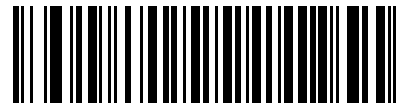

Send GUI 7

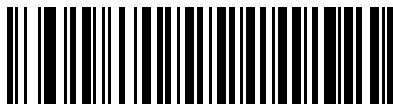

Send GUI 8

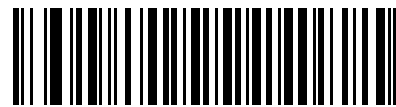

Send GUI 9

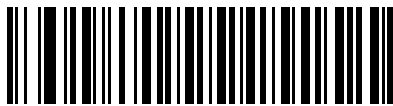

Send GUI A

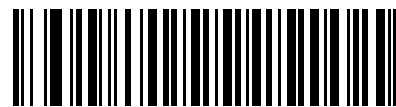

Send GUI B



Send GUI C

## Send Graphic User Interface (GUI) Characters (continued)



Send GUI D



Send GUI E

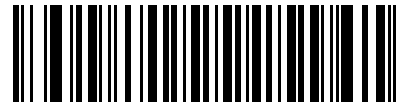

Send GUI F

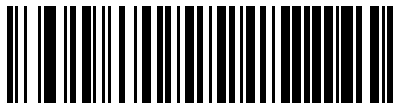

Send GUI G

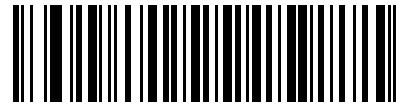

Send GUI H



Send GUI I

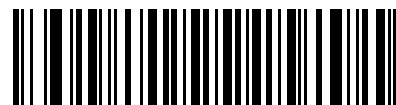

Send GUI J



### Send Graphic User Interface (GUI) Characters (continued)

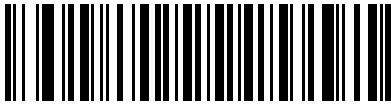

Send GUI K

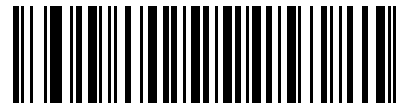

Send GUI L

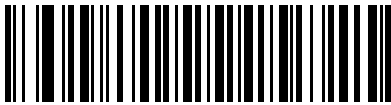

Send GUI M

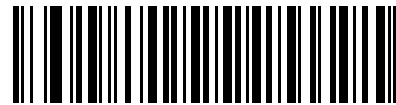

Send GUI N



Send GUI O

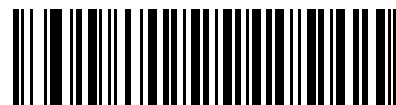

Send GUI P



Send GUI Q

## Send Graphic User Interface (GUI) Characters (continued)



Send GUI R

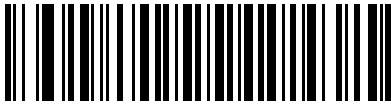

Send GUI S

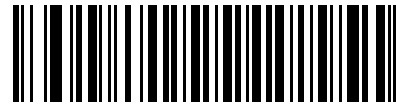

Send GUI T



Send GUI U

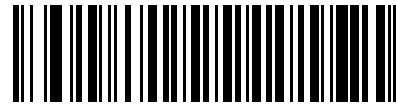

Send GUI V



Send GUI W

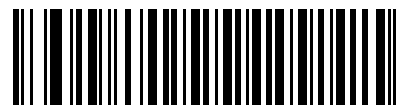

Send GUI X

## Send Graphic User Interface (GUI) Characters (continued)

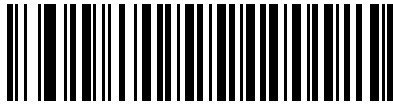

Send GUI Y

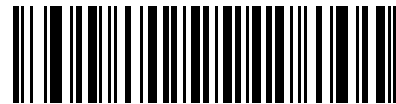

Send GUI Z

## Turn On/Off Rule Sets

Use these bar codes to turn rule sets on and off.



Turn On Rule Set 1



Turn On Rule Set 2



Turn On Rule Set 3



Turn On Rule Set 4

## Turn On/Off Rule Sets (continued)

Use these bar codes to turn rule sets on and off.



Turn Off Rule Set 1



Turn Off Rule Set 2



Turn Off Rule Set 3



Turn Off Rule Set 4

## Alphanumeric Keyboard

---



Space



#



\$



%



\*



+



-  
(Dash)

---

## Alphanumeric Keyboard (continued)



,



.



!



/



&



“



(



{

---

## Alphanumeric Keyboard (continued)



)



:



;



<



=



>



?

---

## Alphanumeric Keyboard (continued)



@



[



\



]



^



—  
(Underscore)



`



---

## Alphanumeric Keyboard (continued)

✓ **NOTE** Do not confuse the numeric bar codes below with those on the numeric keypad.



0



1



2



3



4



5

---

## Alphanumeric Keyboard (continued)



6



7



8



9



A



B



C

---

## Alphanumeric Keyboard (continued)



D



E



F



G



H



I



J

---

## Alphanumeric Keyboard (continued)



K



L



M



N



O



P



Q

---

## Alphanumeric Keyboard (continued)



R



S



T



U



V



W



X

---

## Alphanumeric Keyboard (continued)



Y



Z



Cancel



End of Message



a



b



c

---

## Alphanumeric Keyboard (continued)



d



e



f



g



h



i



j

---

## Alphanumeric Keyboard (continued)



k



l



m



n



o



p



q



---

## Alphanumeric Keyboard (continued)



r



s



t



u



v



w



x

---

## Alphanumeric Keyboard (continued)



y



z



{



|



}



~

# Chapter 15 Maintenance and Troubleshooting

---

## Introduction

This chapter provides suggested maintenance and troubleshooting for the device, batteries and accessories.

---

## Maintenance

For trouble-free service, observe the tips that follow when using the device and its accessories.

### MT20X0

- Do not scratch the screen of the device.
- Although the device is water and dust resistant, do not expose it to rain or moisture for an extended period of time. In general, treat the device as a pocket calculator or other small electronic instrument.
  - Do not clean the device or expose it to rain or moisture when the battery is removed. Without the battery, the device is not water/dust sealed.
- Do not drop the device or subject it to strong impact.
- Protect the device from temperature extremes. Do not leave it on the dashboard of a car on a hot day, and keep it away from heat sources.
- Do not store or use the device in any location that is extremely dusty, damp, or wet.
- Do not store or use the device with the auxiliary accessory cover off. Without the accessory cover, the device is not water/dust sealed.
- Do not use window cleaning solution. Use a soft cloth dampened with a 50/50 solution of isopropyl alcohol and water.
  - Do not allow the solution to form a pool of liquid anywhere on the screen or device.
  - Do not use a large amount of solution to cause the device to remain wet.
  - The display screen and scan window can often be cleaned with common office (Scotch) tape. Apply the tape to surfaces and then peel the tape away; in most cases the dirt can be removed along with the tape.

## Battery



**WARNING!** Do not store the device with the battery installed. Doing so long term may cause irreversible harm to the battery. Always store the battery removed from the device.

If a battery is installed during long term storage, it may discharge to point at which it cannot be recovered.

Even when stored separately from device it is important to follow industry standard guidelines. When batteries are stored over a year, battery cell manufacturers advise that some irreversible deterioration in overall battery quality may occur. To minimize this loss, they recommend storing batteries half charged in a dry, cool place between 41° and 77°F (5° and 25°C), the cooler the better. Batteries should be charged to half capacity at least once a year. In order to charge a battery to half capacity, take a fully discharged battery and charge it for two hours. If an electrolyte leakage is observed, avoid any contact with the affected area and properly dispose of the battery.

## Cradles

- Although the cradles are water and dust resistant, do not expose them to rain or moisture for an extended period of time. In general, treat the cradles as you would a pocket calculator or other electronic instrument.
- Do not drop the cradles or subject them to strong impact.
- Protect the cradles from temperature extremes. Do not leave them in a car on a hot day, and keep them away from heat sources.
- Do not store or use the cradles in any location that is extremely dusty, damp, or wet.
- Use a soft cloth dampened with a 50/50 solution of isopropyl alcohol and water.
  - Do not allow the solution to form a pool of liquid anywhere in the cradle.
  - Do not use a large amount of solution to cause the cradles to remain wet.

---

## Troubleshooting

### MT20X0

**Table 15-1** *Troubleshooting the MT20X0*

<b>Problem</b>	<b>Possible Causes</b>	<b>Possible Solutions</b>
<b>Aiming Pattern</b>		

---

**Table 15-1** *Troubleshooting the MT20X0 (Continued)*

Problem	Possible Causes	Possible Solutions
Aiming pattern does not appear when pressing the trigger.	No power to the device.	If the configuration requires a power supply, re-connect the power supply.
	Incorrect host interface cable is used.	Connect the correct host interface cable.
	Interface/power cables are loose.	Re-connect cables.
	Device is disabled.	For IBM 468x mode, enable the device via the host interface. Otherwise, see the technical person in charge of scanning.
	Device is disabled.	For IBM 468x mode, enable the device via the host interface. Otherwise, see the technical person in charge of scanning.
	If using RS-232 Nixdorf B mode, CTS is not asserted.	Assert CTS line.
	Aiming pattern is disabled.	Enable the aiming pattern. See <a href="#">Aiming on page 3-4</a> .
	Battery may be discharged.	<p>Check the battery status. If the battery is discharged:</p> <ol style="list-style-type: none"> <li>1. Place the device in the charge only cradle with a 12V power supply. The device should power on.</li> <li>2. Attach a cable to the device and connect it to a PC. Wait at least two hours (depending on the level of discharge) for the device to acquire sufficient charge to boot the device. During this period the device appears to be inoperative. A complete charge of a fully discharged battery may take several hours. (See <a href="#">Battery Charging on page 1-14</a>.) If the device does not power up, contact Zebra support. (See <a href="#">Battery Charging on page 1-14</a>.)</li> </ol> <p>If the device does not power up, contact Zebra support.</p>

**Table 15-1** *Troubleshooting the MT20X0 (Continued)*

<b>Problem</b>	<b>Possible Causes</b>	<b>Possible Solutions</b>
Device emits aiming pattern, but does not decode the bar code.	Device is not programmed for the correct bar code type.	Program the device to read that type of bar code. See <a href="#">Chapter 12, Symbologies</a> .
	Bar code symbol is unreadable.	Scan test symbols of the same bar code type to determine if the bar code is defaced.
	The symbol is not completely inside aiming pattern.	Move the symbol completely within the aiming pattern.
	Scan window may be dirty.	Clean the scan window. See <a href="#">Maintenance on page 15-1</a> .
<b>Battery Charging</b>		
Device does not boot when a USB cable is attached.	The device's battery is discharged.	Normal behavior if the battery is severely discharged. The battery must charge at a reduced charge rate until the battery acquires sufficient charge to boot the device. This can take up to two hours, depending on the level of battery discharge.
Device is attached to a host PC via USB cable; PC register boots up after being powered down for an extended period of time; device does not boot.	When the host is powered down, the device remains powered from its battery. This can result in a completely discharged battery.	See above.
<b>Beeping Sequences</b>		
Device emits short low/short medium/short high beep sequence (power-up beep sequence) more than once.	The USB bus may put the device in a state where power to the device is cycled on and off more than once.	Normal during host reset.
Device emits 4 short high beeps during decode attempt.	Device has not completed USB initialization.	Wait several seconds and scan again.
Device emits high/high/high/low beeps when not in use.	RS-232 receive error.	Normal during host reset. Otherwise, set the device's RS-232 parity to match the host setting.
Device emits low/high beeps during programming.	Input error or <b>Cancel</b> bar code was scanned.	Scan the correct numeric bar codes within range for the parameter programmed.
Device emits low/high/low/high beeps during programming.	Out of ADF parameter storage space.	Erase all rules and re-program with shorter rules.
Device emits a power-up beep after changing USB host type.	The USB bus re-established power to the device.	Normal when changing USB host type.

**Table 15-1** Troubleshooting the MT20X0 (Continued)

Problem	Possible Causes	Possible Solutions
Device emits one high beep when not in use.	In RS-232 mode, a <BEL> character was received and Beep on <BEL> option is enabled.	Normal when <b>Beep on &lt;BEL&gt;</b> is enabled and the device is in RS-232 mode.
<b>BTExplorer</b>		
Message box displays, <i>MT2000 Scanner Service Bluetooth Active</i> .	MT2000 Scanner Services is using Bluetooth; Stonestreet SDK only supports one application using Bluetooth at one time.	Shut down MT2000 Scanner Services, or scan <b>Cable Only</b> host mode (see <a href="#">page 5-5</a> ) which shuts down Bluetooth and allows BT Explorer to operate.
<b>Decoding</b>		
Device decodes bar code, but does not transmit the data to the host.	Device is not programmed for the correct host type.	Scan the appropriate host type programming bar code. See the chapter corresponding to the host type.
	Interface cable is loose.	Re-connect the cable.
	If the device emits 4 long low beeps, a transmission error occurred.	Set the device's communication parameters to match the host's setting.
	If the device emits 5 low beeps, a conversion or format error occurred.	Configure the device's conversion parameters properly.
	If the device emits low/high/low beeps, it detected an invalid ADF rule.	Program the correct ADF rules. Refer to the <i>Advanced Data Formatting Programmer Guide</i> .
<b>Host</b>		
Host displays scanned data incorrectly.	Device is not programmed to work with the host.	Scan the appropriate host type programming bar code.
		For RS-232, set the device's communication parameters to match the host's settings.
		For a Keyboard Wedge configuration, program the system for the correct keyboard type, and turn off the CAPS LOCK key.
		Program the proper editing options (e.g., UPC-E to UPC-A Conversion).



**NOTE** If after performing these checks the device still experiences problems, contact the distributor or call Zebra Support. See [page xxiii](#) for information.



## Single Slot Charge Only Cradle

**Table 15-2** Troubleshooting the Single Slot Charge Only Cradle

Symptom	Possible Cause	Action
Charge LEDs do not light when device is inserted.	Cradle is not receiving power.	Ensure the power cable is connected securely to both the cradle and to AC power.
	Device is not seated correctly in the cradle.	Remove and re-insert the device into the cradle, ensuring it is correctly seated.
	Extreme battery temperature.	Battery does not charge if battery temperature is below 32°F (0°C) or above 104°F (40°C).
Device battery is not charging.	Device was removed from cradle or cradle was unplugged from AC power too soon.	Ensure cradle is receiving power. Ensure device is seated correctly. If a device battery is fully depleted, it can take up to four hours to fully recharge the Li-ion battery.
	Battery is faulty.	Verify that other batteries charge properly. If so, replace the faulty battery.
	Device is not fully seated in the cradle.	Remove and re-insert the device into the cradle, ensuring it is correctly seated.
	Extreme battery temperature.	Battery does not charge if battery temperature is below 32°F (0°C) or above 104°F (40°C).
During data communications, no data was transmitted, or transmitted data was incomplete.	Device removed from cradle during communications.	Replace device in cradle and retransmit.
	Incorrect cable configuration.	See the system administrator.
	Communications software is not installed or configured properly.	Perform setup as described in <a href="#">Chapter 4, Radio Communications</a> .
Device does not boot when placed in the cradle.	The device's battery is discharged.	Normal behavior if the battery is severely discharged. The battery must charge at a reduced charge rate until the battery acquires sufficient charge to boot the device. This can take up to two hours, depending on the level of battery discharge. This can be avoided by powering the cradle with the optional external power supply.

## Single Slot Charge Only Vehicle Mount

**Table 15-3** Troubleshooting the Single Slot Charge Vehicle Mount Cradle

Symptom	Possible Cause	Action
Device battery charging LED does not light (when using the power converter).	Cradle is not receiving power.	Ensure cables to cradle and power converter are securely connected.
	Power converter fuse is blown.	Replace power converter fuse.
	Power converter is faulty.	Replace power converter.
Device's battery is not recharging.	Device was removed from the cradle too soon.	Replace the device in the cradle. If the device's battery is fully depleted, it can take four hours to fully recharge the battery.
	Device battery is faulty.	Replace the battery.
	Device was not placed correctly in the cradle.	Remove the device from the cradle, and re-insert. If the battery still does not charge, contact your system administrator.
Device falls out of the cradle during vibrations.	Cradle latches are adjusted incorrectly.	Remove cradle from the shock absorbing plate by unscrewing 3 screws; check that the position of the wall mount conversion dial is set to the wall-mount position; reattach the cradle to the shock absorbing plate.
	Incorrect adapter cup.	Ensure the forklift cup is mounted.
Device does not boot when placed in the cradle.	The device's battery is discharged.	Normal behavior if the battery is severely discharged. The battery must charge at a reduced charge rate until the battery acquires sufficient charge to boot the device. This can take up to two hours, depending on the level of battery discharge. This can be avoided by powering the cradle with the optional external power supply.

## Single Slot Charge Multi-interface

**Table 15-4** *Troubleshooting the Single Slot Charge Multi-interface Cradle*

Symptom	Possible Cause	Action
Device emits a disconnect (short high-short low) beep sequence.	Device has disconnected from cradle because it is too far from the cradle.	Move closer to the cradle and listen for a reconnection beep (short low-short high).
	Device has disconnected from the cradle because the cradle has lost power or been placed in USB suspend mode.	Check power connections to cradle, and if using a USB cable, check to make sure PC has not entered a power save mode.
Device emits four long low beeps after scanning a bar code.	Interface/power cables to cradle are loose.	Ensure all cable connections are secure.
	Device is not paired to a cradle.	Scan the PAIR bar code on the cradle that is connected to the host that is to receive data.
	A transmission error was detected.	Ensure the cradle's communication parameters match the host's setting.
	Cradle has not completed USB initialization.	Wait several seconds and scan again.
Bar code is decoded, but data is not transmitted to the host.	Device not paired to host-connected cradle.	Pair the device to the cradle (using PAIR bar code on the cradle).
	Cradle not programmed for correct host interface.	Check device host parameters or edit options.
	Interface cable is loose.	Ensure all cable connections are secure.
	Cradle has lost connection to host.	In this exact order: disconnect power supply; disconnect host cable; wait three seconds; reconnect host cable; reconnect power supply; reestablish pairing.
Scanned data is incorrectly displayed on the host.	Cradle host communication parameters do not match host's parameters.	Ensure proper host is selected.
		For RS-232, ensure the cradle's communication parameters match the host's settings.
		For a Keyboard Wedge configuration, ensure the system is programmed for the correct keyboard type, and the CAPS LOCK key is off.
		Ensure editing options (e.g., UPC-E to UPC-A conversion) are properly programmed.

**Table 15-4** *Troubleshooting the Single Slot Charge Multi-interface Cradle (Continued)*

Symptom	Possible Cause	Action
Device falls out of the cradle in the wall mount position.	Cradle has an incorrect adapter cup.	Ensure the wall mount adapter cup is installed and not the desktop cup.
	Cradle latches are adjusted incorrectly.	Remove cradle from the shock absorbing plate by unscrewing 3 screws; check that the position of the wall mount conversion dial is set to the wall-mount position; reattach the cradle to the shock absorbing plate.
Device does not boot when placed in the cradle.	The device's battery is discharged.	Normal behavior if the battery is severely discharged. The battery must charge at a reduced charge rate until the battery acquires sufficient charge to boot the device. This can take up to two hours, depending on the level of battery discharge. This can be avoided by powering the cradle with the optional external power supply.
Cradle is not sending bar code data.	Parameter settings were scanned prior to pairing.	Pair device prior to scanning settings.
	USB cable not detected.	Connect the USB cable prior to connecting the 12V power supply.

## Four Slot Charge Only Ethernet

**Table 15-5** Troubleshooting the Four Slot Charge Only Ethernet Cradle

Symptom	Possible Cause	Action
Charge LEDs do not light when device is inserted.	Cradle is not receiving power.	Ensure the power cable is connected securely to both the cradle and to AC power.
	Device is not seated correctly in the cradle.	Remove and re-insert the device into the cradle, ensuring it is correctly seated.
	Extreme battery temperature.	Battery does not charge if battery temperature is below 32°F (0°C) or above 104°F (40°C).
Device battery is not charging.	Device was removed from cradle or cradle was unplugged from AC power too soon.	Ensure cradle is receiving power. Ensure device is seated correctly. If a device battery is fully depleted, it can take up to four hours to fully recharge the Li-ion battery.
	Battery is faulty.	Verify that other batteries charge properly. If so, replace the faulty battery.
	Device is not fully seated in the cradle.	Remove and re-insert the device into the cradle, ensuring it is correctly seated.
	Extreme battery temperature.	Battery does not charge if battery temperature is below 32°F (0°C) or above 104°F (40°C).
During data communications, no data was transmitted, or transmitted data was incomplete.	Device removed from cradle during communications.	Replace device in cradle and retransmit.
	Incorrect cable configuration.	See the system administrator.
	Communications software is not installed or configured properly.	Perform setup as described in <a href="#">Chapter 4, Radio Communications</a> .
Device falls out of the cradle in the wall mount position.	Cradle has an incorrect adapter cup.	Ensure the wall mount adapter cup is installed and not the desktop cup.
	Cradle latches are adjusted incorrectly.	Remove cradle from the shock absorbing plate by unscrewing 3 screws; check that the position of the wall mount conversion dial is set to the wall-mount position; reattach the cradle to the shock absorbing plate.
Device does not boot when placed in the cradle.	The device's battery is discharged.	Normal behavior if the battery is severely discharged. The battery must charge at a reduced charge rate until the battery acquires sufficient charge to boot the device. This can take up to two hours, depending on the level of battery discharge. This can be avoided by powering the cradle with the optional external power supply.

## Four Slot Charge Only Cradle

**Table 15-6** Troubleshooting the Four Slot Charge Only Cradle

Symptom	Possible Cause	Action
Charge LEDs do not light when device is inserted.	Cradle is not receiving power.	Ensure the power cable is connected securely to both the cradle and to AC power.
	Device is not seated correctly in the cradle.	Remove and re-insert the device into the cradle, ensuring it is correctly seated.
	Extreme battery temperature.	Battery does not charge if battery temperature is below 32°F (0°C) or above 104°F (40°C).
Device battery is not charging.	Device was removed from cradle or cradle was unplugged from AC power too soon.	Ensure cradle is receiving power. Ensure device is seated correctly. If a device battery is fully depleted, it can take up to four hours to fully recharge the Li-ion battery.
	Battery is faulty.	Verify that other batteries charge properly. If so, replace the faulty battery.
	Device is not fully seated in the cradle.	Remove and re-insert the device into the cradle, ensuring it is correctly seated.
	Extreme battery temperature.	Battery does not charge if battery temperature is below 32°F (0°C) or above 104°F (40°C).
During data communications, no data was transmitted, or transmitted data was incomplete.	Device removed from cradle during communications.	Replace device in cradle and retransmit.
	Incorrect cable configuration.	See the system administrator.
	Communications software is not installed or configured properly.	Perform setup as described in <a href="#">Chapter 4, Radio Communications</a> .
Device falls out of the cradle in the wall mount position.	Cradle has an incorrect adapter cup.	Ensure the wall mount adapter cup is installed and not the desktop cup.
	Cradle latches are adjusted incorrectly.	Remove cradle from the shock absorbing plate by unscrewing 3 screws; check that the position of the wall mount conversion dial is set to the wall-mount position; reattach the cradle to the shock absorbing plate.
Device does not boot when placed in the cradle.	The device's battery is discharged.	Normal behavior if the battery is severely discharged. The battery must charge at a reduced charge rate until the battery acquires sufficient charge to boot the device. This can take up to two hours, depending on the level of battery discharge. This can be avoided by powering the cradle with the optional external power supply.

## Four Slot Spare Battery Charger

**Table 15-7** *Troubleshooting the Four Slot Spare Battery Cradle*

Symptom	Possible Cause	Action
Charge LEDs do not light when batteries are inserted.	Cradle is not receiving power.	Ensure the power cable is connected securely to both the cradle and to AC power.
	Battery is not seated correctly in the cradle.	Remove and re-insert the battery, ensuring it is correctly seated.
	Extreme battery temperature.	Battery does not charge if battery temperature is below 32°F (0°C) or above 104°F (40°C).
Battery is not charging.	Battery was removed from cradle or cradle was unplugged from AC power too soon.	Ensure cradle is receiving power. Ensure battery is seated correctly. If a battery is fully depleted, it can take up to four hours to fully recharge the Li-ion battery.
	Battery is faulty.	Verify that other batteries charge properly. If so, replace the faulty battery.
	Battery is not fully seated in the cradle.	Remove and re-insert the battery into the cradle, ensuring it is correctly seated.
	Extreme battery temperature.	Battery does not charge if battery temperature is below 32°F (0°C) or above 104°F (40°C).

## Cables

**Table 15-8** *Troubleshooting Cables*

Symptom	Possible Cause	Action
Device charge LED does not light when device is connected.	Cable is not receiving power.	Ensure the power cable is connected securely to both the cable and to AC power.
	Cable is not seated correctly in the device.	Remove and re-insert the cable into the device, ensuring it is correctly seated.
	Extreme battery temperature.	Battery does not charge if battery temperature is below 32°F (0°C) or above 104°F (40°C).
Device battery is not charging.	Device was removed from cable or cable was unplugged from AC power too soon.	Ensure cable is receiving power. Ensure device is seated correctly. If a device battery is fully depleted, it can take up to four hours to fully recharge the battery.
	Battery is faulty.	Verify that other batteries charge properly. If so, replace the faulty battery.
	Cable is not seated correctly in the device.	Remove and re-insert the cable into the device, ensuring it is correctly seated.
	Extreme battery temperature.	Battery will not charge if battery temperature is below 32°F (0°C) or above 104°F (40°C).
During data communication, no data was transmitted, or transmitted data was incomplete.	Cable removed from device during communication.	Reattach cable to device and retransmit.
	Incorrect cable configuration.	See the system administrator.
	Communication software is not installed or configured properly.	Refer to the <i>MT2070/MT2090 Integrator Guide</i> .



**MCL****Table 15-9** *Troubleshooting MCL*

Symptom	Possible Cause	Action
MCL Link/Designer is not communicating with device.	MCL application is not setup to use MCL Link.	Use MCL menu and launch <i>MCL Wait</i> command.
	USB driver is not installed.	Install drivers from product Web site.
	USB driver cannot open.	Previous application has <i>virtual</i> COM port open. Close the <i>virtual</i> COM port.
	Device not paired to STB2078 cradle.	Pair device to cradle.



# Appendix A Standard Default Parameters

**Table A-1** Standard Default Parameters Table

Parameter	Default	Page Number
<b>Radio Communications</b>		
Bluetooth Host (Host Type)	Cradle Host	4-5
Bluetooth Friendly Name	Device name and serial number	4-7
Discoverable Mode	General	4-7
Country Keyboard Types (Country Code)	North American	4-8
HID Keyboard Keystroke Delay	No Delay (0 msec)	4-10
CAPS Lock Override	Disable	4-10
Ignore Unknown Characters	Enable	4-11
Emulate Keypad	Disable	4-11
Keyboard FN1 Substitution	Disable	4-12
Function Key Mapping	Disable	4-12
Simulated Caps Lock	Disable	4-13
Convert Case	No Case Conversion	4-13
Beep on Reconnect Attempt	Disable	4-14
Reconnect Attempt Interval	30 sec	4-15
Auto-reconnect in Bluetooth Keyboard Emulation (HID Slave) Mode	On Bar Code Data	4-17
Modes of Operation (Point-to-Point/Multipoint-to-Point)	Point-to-Point	4-19

<sup>1</sup>User selection is required to configure this interface and this is the most common selection.

**Table A-1** Standard Default Parameters Table (Continued)

Parameter	Default	Page Number
Parameter Broadcast (Cradle Host Only)	Enable	4-20
Pairing Modes	Unlocked	4-20
Pairing on Contacts	Disable	4-20
Connection Maintenance Interval	15 min	4-23
Authentication	Disable	4-26
Variable Pin Code	Static	4-27
Encryption	Disable	4-28
<b>User Preferences</b>		
Set Default Parameter	Set Defaults	5-4
Host Mode	Cable Priority	5-5
Decode Pager Motor Enable	Disable	5-6
Parameter Bar Code Scanning	Enable	5-7
Scan Angle	Wide	5-8
Adaptive Scanning	Enable	5-9
Adaptive Scanning Interference Suppression Mode	Ambient Light Interference Suppression Auto Detection	5-10
Adaptive Scanning Interference Suppression Scan Angle	Wide	5-11
Beep After Good Decode	Enable	5-12
Beeper Tone	Medium	5-13
Beeper Volume	High	5-14
Hand-Held Trigger Mode	Standard (Level)	5-15
Picklist Mode	Disabled Always	5-16
Decode Session Timeout	9.9 Sec	5-15
Timeout Between Decodes, Same Symbol	0.5 Sec	5-17
Hand-Held Decode Aiming Pattern	Enable	5-17
Parameter Pass Through	Disable	5-18
Decoding Illumination	Enable	5-18
Batch Mode	No Batch Mode	5-20

<sup>1</sup>User selection is required to configure this interface and this is the most common selection.

**Table A-1** Standard Default Parameters Table (Continued)

Parameter	Default	Page Number
FIPS Mode	Disable	5-22
DPM Scanning (MT2070-DP only)	Enable	5-22
<b>Miscellaneous Options</b>		
Transmit Code ID Character	None	5-23
Prefix Value	7013 <CR><LF>	5-24
Suffix 1 Value Suffix 2 Value	7013 <CR><LF>	5-24
Scan Data Transmission Format	Data as is	5-25
FN1 Substitution Values	Set	5-26
Transmit "No Read" Message	Disable	5-27
<b>Imaging Preferences</b>		
Operational Modes	N/A	6-4
Image Capture Illumination	Enable	6-5
Snapshot Mode Timeout	0 (30 seconds)	6-6
Snapshot Aiming Pattern	Enable	6-6
Image Cropping	Disable	6-7
Crop to Pixel Addresses	0 top, 0 left, 1023 bottom, 1279 right	6-8
Image Brightness (Target White)	180	6-9
JPEG Quality and Size Value	65	6-9
Image File Format Selection	JPEG	6-10
Signature Capture	Disable	6-11
Signature Capture Image File Format Selection	JPEG	6-12
Signature Capture Width	400	6-13
Signature Capture Height	100	6-13
Signature Capture JPEG Quality	65	6-13
Video View Finder	Disable	6-14
<b>RS-232 Host Parameters</b>		
RS-232 Host Types	Standard	8-6
Baud Rate	9600	8-7

<sup>1</sup>User selection is required to configure this interface and this is the most common selection.

**Table A-1** Standard Default Parameters Table (Continued)

Parameter	Default	Page Number
Parity Type	None	8-9
Stop Bit Select	1 Stop Bit	8-10
Data Bits	8-Bit	8-10
Check Receive Errors	Enable	8-11
Hardware Handshaking	None	8-11
Software Handshaking	None	8-13
Host Serial Response Time-out	2 Sec	8-15
RTS Line State	Low RTS	8-16
Beep on <BEL>	Disable	8-16
Intercharacter Delay	0 msec	8-17
Nixdorf Beep/LED Options	Normal Operation	8-18
Ignore Unknown Characters	Send Bar Code	8-18
<b>USB Host Parameters</b>		
USB Device Type	HID Keyboard Emulation	9-5
CDC COM Port Emulation	Enable	9-7
Symbol Native API (SNAPI) Status Handshaking	Enable	9-7
USB Country Keyboard Types (Country Codes)	North American	9-8
USB Keystroke Delay	No Delay	9-10
USB CAPS Lock Override	Disable	9-10
USB Ignore Unknown Characters	Enable	9-11
USB Ignore Beep Directive	Honor	9-11
USB Ignore Type Directive	Honor	9-12
Emulate Keypad	Disable	9-12
Emulate Keypad with Leading Zero	Disable	9-13
USB FN1 Substitution	Disable	9-13
Function Key Mapping	Disable	9-14
Simulated Caps Lock	Disable	9-14
Convert Case	None	9-15

**USB Transmission Speed Parameters**

<sup>1</sup>User selection is required to configure this interface and this is the most common selection.

**Table A-1** Standard Default Parameters Table (Continued)

Parameter	Default	Page Number
USB Polling Interval	8 msec	9-16
Fast HID Keyboard	Disable	9-18
Quick Keypad Emulation	Disable	9-18
USB HID Over the STB2000 Charge-only Cradle	Disable	9-19
<b>IBM 468X/469X Host Parameters</b>		
Port Address	None Selected	10-4
Convert Unknown to Code 39	Disable	10-5
<b>Keyboard Wedge Host Parameters</b>		
Keyboard Wedge Host Type	IBM PC/AT& IBM PC Compatibles	11-4
Country Types (Country Codes)	North American	11-5
Ignore Unknown Characters	Transmit	11-7
Keystroke Delay	No Delay	11-7
Intra-Keystroke Delay	Disable	11-8
Alternate Numeric Keypad Emulation	Disable	11-8
Caps Lock On	Disable	11-9
Caps Lock Override	Disable	11-9
Convert Wedge Data	No Convert	11-10
Function Key Mapping	Disable	11-10
FN1 Substitution	Disable	11-11
Send and Make Break	Send	11-11
<b>UPC/EAN</b>		
UPC-A	Enable	12-7
UPC-E	Enable	12-7
UPC-E1	Disable	12-8
EAN-8/JAN 8	Enable	12-8
EAN-13/JAN 13	Enable	12-9
Bookland EAN	Disable	12-9
Decode UPC/EAN/JAN Supplementals (2 and 5 digits)	Ignore	12-10

<sup>1</sup>User selection is required to configure this interface and this is the most common selection.

**Table A-1** Standard Default Parameters Table (Continued)

Parameter	Default	Page Number
User-Programmable Supplementals Supplemental 1: Supplemental 2:		12-13
UPC/EAN/JAN Supplemental Redundancy	10	12-13
UPC/EAN/JAN Supplemental AIM ID Format	Combined	12-14
Transmit UPC-A Check Digit	Enable	12-14
Transmit UPC-E Check Digit	Enable	12-15
Transmit UPC-E1 Check Digit	Enable	12-16
UPC/EAN/JAN Supplemental AIM ID Format	Combined	12-14
UPC-A Preamble	System Character	12-16
UPC-E Preamble	System Character	12-17
UPC-E1 Preamble	System Character	12-18
Convert UPC-E to A	Disable	12-19
Convert UPC-E1 to A	Disable	12-19
EAN-8/JAN-8 Extend	Disable	12-20
Bookland ISBN Format	ISBN-10	12-21
UCC Coupon Extended Code	Enable	12-22
ISSN EAN	Disable	12-23
<b>Code 128</b>		
Code 128	Enable	12-24
Set Length(s) for Code 128	Any Length	12-24
GS1-128 (formerly UCC/EAN-128)	Enable	12-26
ISBT 128	Enable	12-26
ISBT Concatenation	Disable	12-27
Check ISBT Table	Enable	12-28
<b>Code 39</b>		
Code 39	Enable	12-29
Trioptic Code 39	Disable	12-29
Convert Code 39 to Code 32 (Italian Pharmacy Code)	Disable	12-30

<sup>1</sup>User selection is required to configure this interface and this is the most common selection.



**Table A-1** Standard Default Parameters Table (Continued)

Parameter	Default	Page Number
Code 32 Prefix	Disable	12-30
Set Length(s) for Code 39	2 to 55	12-31
Code 39 Check Digit Verification	Disable	12-32
Transmit Code 39 Check Digit	Disable	12-32
Code 39 Full ASCII Conversion	Disable	12-33
<b>Code 93</b>		
Code 93	Disable	12-34
Set Length(s) for Code 93	4 to 55	12-34
<b>Code 11</b>		
Code 11	Disable	12-36
Set Lengths for Code 11	4 to 55	12-36
Code 11 Check Digit Verification	Disable	12-38
Transmit Code 11 Check Digit(s)	Disable	12-39
<b>Interleaved 2 of 5 (I 2 of 5)</b>		
Interleaved 2 of 5 (ITF)	Disable	12-39
Set Lengths for I 2 of 5	14	12-40
I 2 of 5 Check Digit Verification	Disable	12-42
Transmit I 2 of 5 Check Digit	Disable	12-42
Convert I 2 of 5 to EAN 13	Disable	12-43
<b>Discrete 2 of 5 (D 2 of 5)</b>		
Discrete 2 of 5	Disable	12-43
Set Length(s) for D 2 of 5	12	12-44
<b>Codabar (NW - 7)</b>		
Codabar	Disable	12-46
Set Lengths for Codabar	5 to 55	12-46
CLSI Editing	Disable	12-48
NOTIS Editing	Disable	12-48
Codabar Upper or Lower Case Start/Stop Characters Detection	Upper Case	12-49

<sup>1</sup>User selection is required to configure this interface and this is the most common selection.

**Table A-1** Standard Default Parameters Table (Continued)

Parameter	Default	Page Number
<b>MSI</b>		
MSI	Disable	12-50
Set Length(s) for MSI	4 to 55	12-50
MSI Check Digits	One	12-52
Transmit MSI Check Digit	Disable	12-52
MSI Check Digit Algorithm	Mod 10/Mod 10	12-53
<b>Matrix 2 of 5</b>		
Matrix 2 of 5	Disable	12-54
Matrix 2 of 5 Lengths	One Length: 14	12-54
Matrix 2 of 5 Check Digit	Disable	12-56
Transmit Matrix 2 of 5 Check Digit	Disable	12-56
<b>Chinese 2 of 5</b>		
Chinese 2 of 5	Disable	12-57
<b>Korean 3 of 5</b>		
Korean 3 of 5	Disable	12-57
<b>Inverse 1D</b>		
Inverse 1D	Regular	12-58
<b>Postal Codes</b>		
US Postnet	Disable	12-59
US Planet	Disable	12-59
Transmit US Postal Check Digit	Enable	12-60
UK Postal	Disable	12-60
Transmit UK Postal Check Digit	Enable	12-61
Japan Postal	Disable	12-61
Australian Postal	Disable	12-62
Australia Post Format	Autodiscriminate	12-63
Netherlands KIX Code	Disable	12-64
USPS 4CB/One Code/Intelligent Mail	Disable	12-64
UPU FICS Postal	Disable	12-65

<sup>1</sup>User selection is required to configure this interface and this is the most common selection.

**Table A-1** Standard Default Parameters Table (Continued)

Parameter	Default	Page Number
<b>GS1 DataBar</b>		
GS1 DataBar-14	Disable	12-66
GS1 DataBar Limited	Disable	12-66
GS1 DataBar Expanded	Disable	12-67
Convert GS1 DataBar to UPC/EAN	Disable	12-67
GS1 DataBar Limited Security Level	Security Level 3	12-68
<b>Composite</b>		
Composite CC-C	Disable	12-69
Composite CC-A/B	Disable	12-69
Composite TLC-39	Disable	12-70
UPC Composite Mode	Never Linked	12-70
Composite Beep Mode	Beep as Each Code Type is Decoded	12-71
<b>2D Symbologies</b>		
PDF417	Enable	12-71
MicroPDF417	Disable	12-72
Code 128 Emulation	Disable	12-73
Data Matrix	Enable	12-74
Maxicode	Enable	12-74
QR Code	Enable	12-75
MicroQR	Enable	12-75
Aztec	Enable	12-76
<b>Symbology - Specific Security Levels</b>		
Redundancy Level	1	12-77
Security Level	0	12-79
Report Version		12-80

<sup>1</sup>User selection is required to configure this interface and this is the most common selection.



# Appendix B Programming Reference

---

## Symbol Code Identifiers

**Table B-1** *Symbol Code Characters*

Code Character	Code Type
A	UPC-A, UPC-E, UPC-E1, EAN-8, EAN-13
B	Code 39, Code 32
C	Codabar
D	Code 128, ISBT 128, ISBT 128 Concatenated
E	Code 93
F	Interleaved 2 of 5
G	Discrete 2 of 5, or Discrete 2 of 5 IATA
H	Code 11
J	MSI
K	GS1-128
L	Bookland EAN
M	Trioptic Code 39
N	Coupon Code
R	GS1 DataBar Family
S	Matrix 2 of 5
T	UCC Composite, TLC 39
U	Chinese 2 of 5

**Table B-1** *Symbol Code Characters (Continued)*

<b>Code Character</b>	<b>Code Type</b>
V	Korean 3 of 5
X	ISSN EAN, PDF417, Macro PDF417, Micro PDF417
z	Aztec, Aztec Rune
P00	Data Matrix
P01	QR Code, MicroQR
P02	Maxicode
P03	US Postnet
P04	US Planet
P05	Japan Postal
P06	UK Postal
P08	Netherlands KIX Code
P09	Australian Postal
P0A	USPS 4CB/One Code/Intelligent Mail
P0B	UPU FICS Postal
P0X	Signature Capture

## AIM Code Identifiers

Each AIM Code Identifier contains the three-character string **Jcm** where:

- J = Flag Character (ASCII 93)
- c = Code Character (see [Table B-2](#))
- m = Modifier Character (see [Table B-3](#))

**Table B-2** Aim Code Characters

Code Character	Code Type
A	Code 39, Code 39 Full ASCII, Code 32
C	Code 128, ISBT 128, ISBT 128 Concatenated, GS1-128, Coupon (Code 128 portion)
d	Data Matrix
E	UPC/EAN, Coupon (UPC portion)
e	GS1 DataBar Family
F	Codabar
G	Code 93
H	Code 11
I	Interleaved 2 of 5
L	PDF417, Macro PDF417, Micro PDF417
L2	TLC 39
M	MSI
Q	QR Code, MicroQR
S	Discrete 2 of 5, IATA 2 of 5
U	Maxicode
z	Aztec, Aztec Rune
X	Bookland EAN, ISSN EAN, Trioptic Code 39, Chinese 2 of 5, Matrix 2 of 5, Korean 3 of 5, US Postnet, US Planet, UK Postal, Japan Postal, Australian Postal, Netherlands KIX Code, USPS 4CB/One Code/Intelligent Mail, UPU FICS Postal, Signature Capture

The modifier character is the sum of the applicable option values based on [Table B-3](#).

**Table B-3** *Modifier Characters*

Code Type	Option Value	Option
<b>Code 39</b>	0	No check character or Full ASCII processing.
	1	Reader has checked one check character.
	3	Reader has checked and stripped check character.
	4	Reader has performed Full ASCII character conversion.
	5	Reader has performed Full ASCII character conversion and checked one check character.
	7	Reader has performed Full ASCII character conversion and checked and stripped check character.
	Example: A Full ASCII bar code with check character W, <b>A+I+MI+DW</b> , is transmitted as <b>J</b> A7AIMID where 7 = (3+4).	
<b>Trioptic Code 39</b>	0	No option specified at this time. Always transmit 0.
	Example: A Trioptic bar code 412356 is transmitted as <b>J</b> X0412356	
<b>Code 128</b>	0	Standard data packet, no Function code 1 in first symbol position.
	1	Function code 1 in first symbol character position.
	2	Function code 1 in second symbol character position.
	Example: A Code (EAN) 128 bar code with Function 1 character <sup>FNC1</sup> in the first position, AIMID is transmitted as <b>J</b> C1AIMID	
<b>I 2 of 5</b>	0	No check digit processing.
	1	Reader has validated check digit.
	3	Reader has validated and stripped check digit.
	Example: An I 2 of 5 bar code without check digit, 4123, is transmitted as <b>J</b> I04123	
<b>Codabar</b>	0	No check digit processing.
	1	Reader has checked check digit.
	3	Reader has stripped check digit before transmission.
	Example: A Codabar bar code without check digit, 4123, is transmitted as <b>J</b> F04123	
<b>Code 93</b>	0	No options specified at this time. Always transmit 0.
	Example: A Code 93 bar code 012345678905 is transmitted as <b>J</b> G0012345678905	
<b>MSI</b>	0	Check digits are sent.
	1	No check digit is sent.
	Example: An MSI bar code 4123, with a single check digit checked, is transmitted as <b>J</b> M14123	



Table B-3 Modifier Characters (Continued)

Code Type	Option Value	Option
<b>D 2 of 5</b>	0	No options specified at this time. Always transmit 0.
	Example: A D 2 of 5 bar code 4123, is transmitted as <b>JS04123</b>	
<b>UPC/EAN</b>	0	Standard data packet in full EAN format, i.e. 13 digits for UPC-A, UPC-E, and EAN-13 (not including supplemental data).
	1	Two digit supplemental data only.
	2	Five digit supplemental data only.
	3	Combined data packet comprising 13 digits from EAN-13, UPC-A or UPC-E symbol and 2 or 5 digits from supplemental symbol.
	4	EAN-8 data packet.
Example: A UPC-A bar code 012345678905 is transmitted as <b>JE00012345678905</b>		
<b>Bookland EAN</b>	0	No options specified at this time. Always transmit 0.
	Example: A Bookland EAN bar code 123456789X is transmitted as <b>JX0123456789X</b>	
<b>ISSN EAN</b>	0	No options specified at this time. Always transmit 0.
	Example: An ISSN EAN bar code 123456789X is transmitted as <b>JX0123456789X</b>	
<b>Code 11</b>	0	Single check digit
	1	Two check digits
	3	Check characters validated but not transmitted.
<b>GS1 DataBar Family</b>		No option specified at this time. Always transmit 0. GS1 DataBar-14 and GS1 DataBar Limited transmit with an Application Identifier "01". Note: In GS1-128 emulation mode, GS1 DataBar is transmitted using Code 128 rules (i.e., JC1).
	Example: A GS1 DataBar-14 bar code 0110012345678902 is transmitted as <b>Je00110012345678902</b> .	

Table B-3 Modifier Characters (Continued)

Code Type	Option Value	Option
<b>EAN.UCC Composites (GS1 DataBar, GS1-128, 2D portion of UPC composite)</b>		Native mode transmission. Note: UPC portion of composite is transmitted using UPC rules.
	0	Standard data packet.
	1	Data packet containing the data following an encoded symbol separator character.
	2	Data packet containing the data following an escape mechanism character. The data packet does not support the ECI protocol.
	3	Data packet containing the data following an escape mechanism character. The data packet supports the ECI protocol.
		GS1-128 emulation Note: UPC portion of composite is transmitted using UPC rules.
	1	Data packet is a GS1-128 symbol (i.e., data is preceded with ]JC1).
<b>PDF417, Micro PDF417</b>	0	Reader set to conform to protocol defined in 1994 PDF417 symbology specifications. <b>Note:</b> When this option is transmitted, the receiver cannot reliably determine whether ECIs have been invoked or whether data byte 92 <sub>DEC</sub> has been doubled in transmission.
	1	Reader set to follow the ECI protocol (Extended Channel Interpretation). All data characters 92 <sub>DEC</sub> are doubled.
	2	Reader set for Basic Channel operation (no escape character transmission protocol). Data characters 92 <sub>DEC</sub> are not doubled. <b>Note:</b> When decoders are set to this mode, unbuffered Macro symbols and symbols requiring the decoder to convey ECI escape sequences cannot be transmitted.
	3	The bar code contains a GS1-128 symbol, and the first codeword is 903-907, 912, 914, 915.
	4	The bar code contains a GS1-128 symbol, and the first codeword is in the range 908-909.
	5	The bar code contains a GS1-128 symbol, and the first codeword is in the range 910-911.
	Example: A PDF417 bar code ABCD, with no transmission protocol enabled, is transmitted as ]L2ABCD.	

**Table B-3** *Modifier Characters (Continued)*

<b>Code Type</b>	<b>Option Value</b>	<b>Option</b>
<b>Data Matrix</b>	0	ECC 000-140, not supported.
	1	ECC 200.
	2	ECC 200, FNC1 in first or fifth position.
	3	ECC 200, FNC1 in second or sixth position.
	4	ECC 200, ECI protocol implemented.
	5	ECC 200, FNC1 in first or fifth position, ECI protocol implemented.
	6	ECC 200, FNC1 in second or sixth position, ECI protocol implemented.
<b>MaxiCode</b>	0	Symbol in Mode 4 or 5.
	1	Symbol in Mode 2 or 3.
	2	Symbol in Mode 4 or 5, ECI protocol implemented.
	3	Symbol in Mode 2 or 3, ECI protocol implemented in secondary message.
<b>QR Code</b>	0	Model 1 symbol.
	1	Model 2 / MicroQR symbol, ECI protocol not implemented.
	2	Model 2 symbol, ECI protocol implemented.
	3	Model 2 symbol, ECI protocol not implemented, FNC1 implied in first position.
	4	Model 2 symbol, ECI protocol implemented, FNC1 implied in first position.
	5	Model 2 symbol, ECI protocol not implemented, FNC1 implied in second position.
	6	Model 2 symbol, ECI protocol implemented, FNC1 implied in second position.
<b>Aztec</b>	0	Aztec symbol.
	C	Aztec Rune symbol.



# Appendix C Sample Bar Codes

---

## UPC-A



---

## UPC-E



---

## UPC-E1



---

## EAN-13



---

## EAN-8



---

## Code 39



---

**Trioptic Code 39**



456123

---

**Code 93**



12345ABCDE

---

**Code 11**



Æ1234567890Æ

---

## Code 128



---

## Codabar



---

## MSI



---

## Interleaved 2 of 5





---

**PDF417**



---

**Data Matrix**



---

**Maxicode**

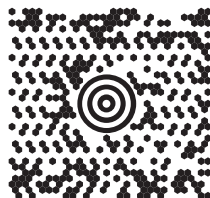

## QR Code



---

## US Postnet



---

## UK Postal



# Appendix D Numeric Bar Codes

---

## 0, 1, 2, 3

For parameters requiring specific numeric values, scan the appropriately numbered bar code(s).



0



1



2



3

## 4, 5, 6, 7

For parameters requiring specific numeric values, scan the appropriately numbered bar code(s).



4



5



6



7

---

**8, 9**

For parameters requiring specific numeric values, scan the appropriately numbered bar code(s).

**8****9**

---

**Cancel**

In case of an error or to change the selection, scan the bar code below.

**Cancel**



# Appendix E Alphanumeric Bar Codes

---

## Alphanumeric Keyboard

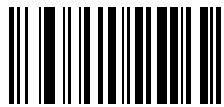

Space

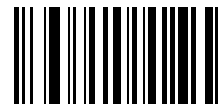

#



\$



%

---

## Alphanumeric Keyboard (continued)



\*

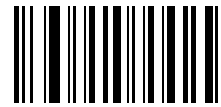

+



-



.



/



!



---

## Alphanumeric Keyboard (continued)



“



&



’



(

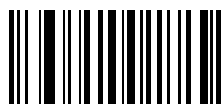

)



:

---

## Alphanumeric Keyboard (continued)



;

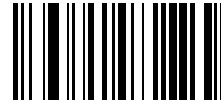

<



=



>

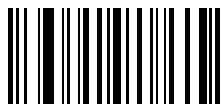

?



@

---

## Alphanumeric Keyboard (continued)

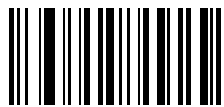

[



\



]



^

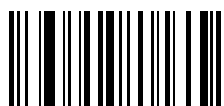

\_

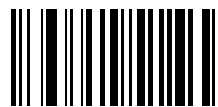

`

---

## Alphanumeric Keyboard (continued)



**NOTE** Do not confuse the bar codes that follow with those on the numeric keypad.

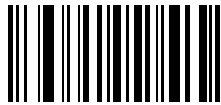

0

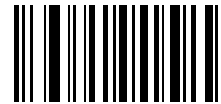

1



2

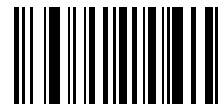

3



4

---

## Alphanumeric Keyboard (continued)

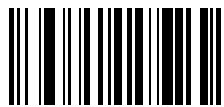

5



6

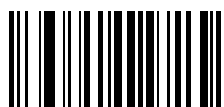

7



8



9



End of Message



Cancel

---

## Alphanumeric Keyboard (continued)



A



B

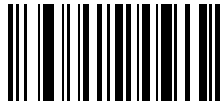

C

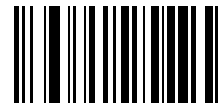

D

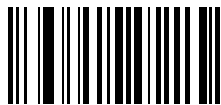

E



F

---

## Alphanumeric Keyboard (continued)

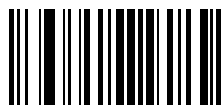

G



H



I



J



K



L

---

## Alphanumeric Keyboard (continued)



M



N



O



P

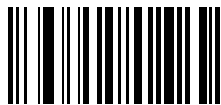

Q

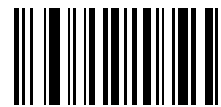

R



---

## Alphanumeric Keyboard (continued)



S



T

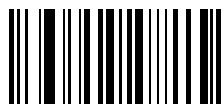

U



V

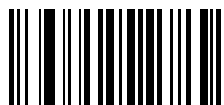

W



X

---

## Alphanumeric Keyboard (continued)



Y



Z

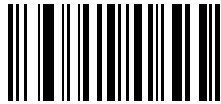

a

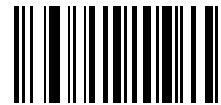

b

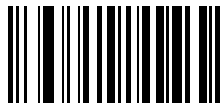

c



d

---

## Alphanumeric Keyboard (continued)

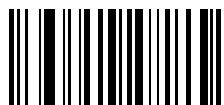

e



f

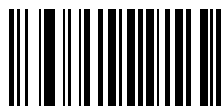

g



h

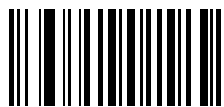

i



j

---

## Alphanumeric Keyboard (continued)



k

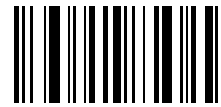

l



m

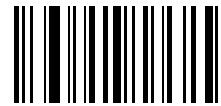

n



o

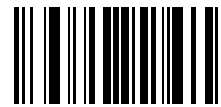

p

---

## Alphanumeric Keyboard (continued)



q



r

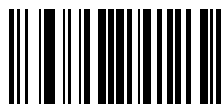

s

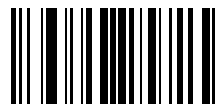

t



u



v

---

## Alphanumeric Keyboard (continued)



w

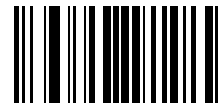

x

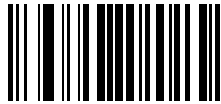

y

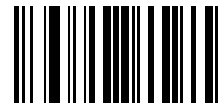

z



{

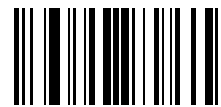

|

---

## Alphanumeric Keyboard (continued)



}



~





# Appendix F Signature Capture Code

---

## Introduction

CapCode, a signature capture code, is a special pattern that encloses a signature area on a document and allows a device to capture a signature.

There are several accepted patterns that allow automatic identification of different signatures on the same form. For example, on the federal tax return 1040 form there are three signature areas, one each for two joint filers, and one for a professional preparer. By using different patterns, a program can correctly identify all three, so they can be captured in any sequence and still be identified correctly.

---

## Code Structure

### Signature Capture Area

A CapCode is printed as two identical patterns on either side of a signature capture box, as shown in [Figure F-1](#). Each pattern extends the full height of the signature capture box.

The box is optional, so you can omit it, replace it with a single baseline, or print a baseline with an "X" on top of it towards the left, as is customarily done in the US to indicate a request for signature. However, if an "X" or other markings are added in the signature box area, these are captured with the signature.



**Figure F-1** CapCode

## CapCode Pattern Structure

A CapCode pattern structure consists of a start pattern followed by a separator space, a signature capture box, a second separator space, and then a stop pattern. Assuming that X is the dimension of the thinnest element, the start and stop patterns each contains 9X total width in 4 bars and 3 spaces. A 7X quiet zone is required to the left and to the right of the CapCode pattern.

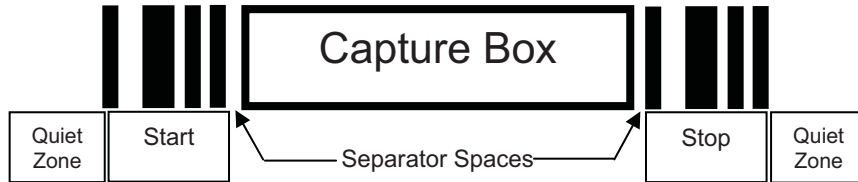

Figure F-2 CapCode Structure

The separator spaces on either side of the signature capture box can be between 1X and 3X wide.

## Start / Stop Patterns

Table F-1 lists the accepted start / stop patterns. The bar and space widths are expressed as multiples of X. You must use the same pattern on either side of a signature capture box. The type value is reported with the captured signature to indicate the purpose of the signature captured.

Table F-1 Start / Stop Pattern Definitions

Bar/Space Patterns							Type
B	S	B	S	B	S	B	
1	1	2	2	1	1	1	2
1	2	2	1	1	1	1	5
2	1	1	2	1	1	1	7
2	2	1	1	1	1	1	8
3	1	1	1	1	1	1	9

[Table F-2](#) lists selectable parameters used to generate the image of the captured signature.

**Table F-2** *User Defined CapCode Parameters*

Parameter	Defined
Width	Number of pixels
Height	Number of pixels
Format	JPEG, BMP, TIFF
JPEG quality	1 (most compression) to 100 (best quality)
Bits Per Pixel (not applicable to JPEG format)	1 (2 levels)
	4 (16 levels)
	8 (256 levels)

BMP format does not use compression, JPEG and TIFF formats do.

## Dimensions

The size of the signature capture box is determined by the height and separation of the start and stop patterns. The line width of the signature capture box is insignificant.

The thinnest element width, referred to here as X, is nominally 10 mils (1 mil = 0.0254 mm). Select this as an exact multiple of the pixel pitch of the printer used. For example, when using a 203 DPI (dots-per-inch) printer and printing 2 dots per module, the resulting X dimension is 9.85 mils.

## Data Format

The device output is formatted according to [Table F-3](#). Devices allow different user options to output or inhibit bar code type. Selecting "Symbol ID" as the bar code type for output identifies the CapCode with letter "i".

**Table F-3** *Data Format*

File Format (1 byte)	Type (1 byte)	Image Size (4 bytes, BIG Endian)	Image Data
JPEG - 1 BMP - 3 TIFF - 4	See <a href="#">Table F-1</a> , last column		(Same bytes as in a data file)

---

## Additional Capabilities

Regardless of how the signature is captured, the output signature image is de-skewed and right-side up.

A device that captures signatures automatically determines whether it is scanning a signature or a bar code. You can disable the signature capturing capability in a device.

---

## Signature Boxes

*Figure F-3* illustrates the five acceptable signature boxes:

Type 2:



Type 5:



Type 7:



Type 8:



Type 9:



**Figure F-3** *Acceptable Signature Boxes*

# Appendix G Quick Startup Exercises

---

## Introduction

This chapter provides various exercises to help the user get familiar with the device and accessories. The following topics are included.

- Establishing an ActiveSync Connection [on page G-2](#)
- Establishing a Bluetooth (BT) Connection Using Open Bluetooth [on page G-3](#)
- Establishing a Bluetooth (BT) Connection Using the STB2070 Cradle [on page G-4](#)
- Customizing the Home Screen Menu [on page G-5](#)
- Modifying the Startup Program [on page G-5](#)
- Disabling Scanner Services [on page G-5](#).

---

## Establishing an ActiveSync Connection

The MT2000 runs the CE.NET 5.0 Core OS which is supported by ActiveSync v4.5 for Windows XP and Windows Mobile Center for Window 7 and Vista. An ActiveSync connection on the MT2000 can be set up with the STB2000 cradle. The STB2000 cradle is an ActiveSync and charge only cradle and cannot be used to communicate via Bluetooth.

If an STB2000 cradle is unavailable, a USB cable (p/n CBAU01-S07ZAR) can be connected directly into the MT2000.

✓ **NOTE** If connecting ActiveSync via USB, it is recommended you use an ESD dongle with the USB cable. (ESD part numbers KT-8830-03R -3 piece kit, or KT-8830-10R - 10 piece kit.)

### Using the STB2000 Cradle and USB Cable

1. Ensure ActiveSync v4.5 or Windows Mobile Center is installed on the PC. Visit <http://www.microsoft.com> for ActiveSync downloads.
2. Connect the USB cable to the STB2000 cradle and to the PC.
3. Place the MT2000 into the STB2000 cradle. ActiveSync should autodetect and make the connection.
4. To view the files loaded on the device, click **Explore** in the ActiveSync window.

### Using Only a USB Cable

✓ **NOTE** Prior to connecting a USB cable to the device, ensure an appropriate tool is available to remove the cable connected to the device.

1. Connect the USB cable to the bottom of the MT2000 and to the PC. Ensure a **U** displays in the upper right corner of the MT2000 screen. This indicates the cable connection was detected.
2. From the MT2000 *Home* menu click *Config > Config USB*. Scroll to ActiveSync and click **Enter**. Click **Close**.
3. ActiveSync should autodetect and make the connection.
4. To view the files loaded on the device click **Explore** in the ActiveSync window.

---

## Establishing a Bluetooth (BT) Connection Using Open Bluetooth

✓ **NOTE** This is not using BTE Explorer.

✓ **NOTE** PC/laptop manufacturers may use different screens throughout enumerator configuration. The exercise below is a generic setup.

Exercise: Follow the steps below to connect as HID slave and Serial Port Profile slave, and transmit data to Notepad and HyperTerminal. Required equipment: MT2000, laptop with built-in BT or BT dongle.

To connect as HID slave:

1. Open *Scan Item* from *Home* menu.
2. Scan [Set Default Parameter on page 5-4](#).
3. Scan [Bluetooth Keyboard Emulation \(HID Slave\) on page 4-5](#).
4. Scan [Variable PIN Code Mode on page 4-27](#) (this allows the pin generated by the BT enumerator to stay on the monitor long enough to enter into the MT2000).
5. On the laptop, open *Discover available BT devices*. Click on the MT2000 and click **Next**.
6. The pin should be displayed. Use the keypad to enter the pin code into the MT2000 and click **Enter** to accept.
7. The BT icon on the top left corner of the MT2000 screen should fill in green.
8. Open Microsoft Word on the laptop and use the MT2000 to scan a product bar code. If the BT connection is successful, the bar code value should display in Word.

To connect as Serial Port Profile slave:

1. Scan [Set Default Parameter on page 5-4](#).
2. Scan [Serial Port Profile \(Slave\) on page 4-5](#).
3. On the laptop, open *Discover available BT devices*. Click on the MT2000 and click **Next**.
4. Depending on your BT enumerator it should prompt you to enter a PIN code. In the enumerator on the laptop, enter 12345. View the COM port assigned.
5. The BT icon on the top left corner of the MT2000 screen should fill in green.
6. Open HyperTerminal and scan a product bar code.

---

## Establishing a Bluetooth (BT) Connection Using the STB2070 Cradle

The STB2078 is a BT communication and charging cradle. ActiveSync does not work with this cradle.

Exercise: Connect BT using the STB2078 cradle. Required equipment: MT2000, STB2078, USB cable (p/n CBAU01-S07ZAR).

1. Connect the USB cable to the STB2078 cradle and to the PC (**do not** apply power to the cradle before establishing communication).
2. Open the *Scan item* application.
3. Scan [Set Default Parameter on page 5-4](#).
4. Scan the **Pair** bar code in the well of the cradle.
5. The BT icon on the top left of the MT screen should fill in green.

## Using the Scan Item Application with the STB2078 Cradle

*Scan item* is an application that allows you to scan and transmit data from the MT2000 to the host. *Scan item* is similar to the default application loaded on the P370/470 scanners.

1. Pair the MT2000 to the cradle using the steps in [Establishing a Bluetooth \(BT\) Connection Using the STB2070 Cradle](#) above.
2. Open the *Scan Item* application on the MT2000.
3. On the host PC, open a program (such as HyperTerminal if using RS232 host, or any text programs such as Notepad, Wordpad, Microsoft Word etc. if using HID USB host ) to view the decoded data.
4. Using the MT2000, scan a product bar code. The data should appear in the opened program.

## Using the Scan Inventory Application with the STB2078 Cradle

*Scan Inventory* is an application that allows you to scan and store data. The user initiates the transfer from the MT2000 to the host. *Scan Inventory* is similar to the default application loaded on the P360/460 scanners.

1. Pair the MT2000 to the cradle using the steps in [Establishing a Bluetooth \(BT\) Connection Using the STB2070 Cradle](#) above.
2. Open the *Scan Inventory* application on the MT2000.
3. On the host PC, open a program (such as HyperTerminal if using RS232 host, or any text programs such as Notepad, Wordpad, Microsoft Word etc. if using HID USB host ) to view the decoded data.
4. Using the MT2000, scan several product bar codes.
5. Click *Menu > View Inventory - Menu > Transmit*. The data should appear in the opened program.



**NOTE** In lieu of Bluetooth, *Scan Item* and *Scan Inventory* applications operate with a USB cable connected directly to the host PC and the bottom of the MT2000, respectively.



---

## Customizing the Home Screen Menu

The contents of the *Home* screen (Navigator.exe) are driven by an XML file named Navigator.xml which resides in the *Platform* folder on the device. See [page 7-3](#) for detailed information about the Navigator.xml file and customizing the *Home* screen.

Using the STB2000 cradle and a USB cable (p/n CBAU01-S07ZAR) with the MT2070, follow these steps to change the view of the *Home* screen *Menu* to only display *Scan item*.

1. ActiveSync to the MT2000 and navigate into the *Platform* folder.
2. Copy the Navigator.xml file to the host PC and make a backup copy on the PC.
3. Open the Navigator.xml file in Notepad and make the modifications.
4. Save the file.
5. ActiveSync the updated Navigator.xml file to the *Platform* folder on the MT2000.
6. Cold boot the device for the settings to take effect. To cold boot the device, press the number 2 key and trigger simultaneously until the screen refreshes twice and the characters >>> display on the screen.

---

## Modifying the Startup Program

By default, Navigator.exe is the startup program for the device. This program provides the *Home* screen view and accessibility to the demo/config applications such as *Scan Item* and *Scan Inventory*. Although these applications are very useful, they may not be appropriate for the end user. For this reason, customizing the \Application\Startup\StartMenu.Run file can alter the default startup application.

Exercise: Follow the steps below to change the startup program from Navigator.exe to Scan Item. Required equipment: STB2000 cradle, USB cable (p/n CBAU01-S07ZAR) and the MT2070.

1. ActiveSync to the MT2070 and navigate into the \Application\Startup folder.
2. Copy the StartMenu.Run file to the host PC and make a backup copy on the PC.
3. Open the StartMenu.Run file in Notepad.
4. Modify the file to run *Scan Item* (which is located in the *Windows* folder on the MT2070).
5. Save the file.
6. ActiveSync the updated StartMenu.Run file to the \Application\Startup folder of the MT2070.
7. Cold boot the device for the settings to take effect. To cold boot the device, press the number 2 key and trigger simultaneously until the screen refreshes twice and the characters >>> display on the screen.

---

## Disabling Scanner Services

In some cases, developers may choose to disable MT2000 Scanner Services which enables the hand-held scan and transmit operation on a Windows CE 5.0 device. When disabled, ScanItem.exe and ScanInventory.exe applications do not operate. In addition, connection to the STB2078 cradle, the Bluetooth-to-computer bridge, cannot operate as it relies on MT2000 Scanner Services to implement the necessary communications. Disable

MT2000 Scanner Services only when the MT20X0 is used as a mobile computing device. Required equipment: STB2000, USB cable (p/n CBAU01-S07ZAR) and the MT2070.

1. Access the *Platform* folder on the device via File Explorer.
2. Delete the ADCServices.reg file.

✓ **NOTE** Alternately, you can also stop MT2000 Scanner Services from running programmatically by issuing the ADCAPI\_StopService() C API.

3. Cold boot the device for the settings to take effect. To cold boot the device, press the number 2 key and trigger simultaneously until the screen refreshes twice and the characters >>> display on the screen.

# Index

## Numerics

2D bar codes	
aztec	12-73
code 128 emulation	12-70
data matrix	12-71
maxicode	12-71
microPDF417	12-69
microQR	12-72
PDF417	12-68
QR code	12-72

## A

accessories	1-2
four slot Ethernet cradle	13-2
four slot USB cradle	13-1, 13-8
single slot cradle	
LED indicators	13-5
single slot multi-interface	
Bluetooth cradle	13-1
USB cradle	13-1, 13-2
actions	14-2
ActiveSync	
configure USB	2-102
cradle	1-1, 1-4, 13-1
ESD dongle	1-1, 2-102
establish connection	G-2
address	
Bluetooth	2-15
MAC	2-15
ADF	14-1
actions	14-1, 14-27
move cursor	14-31
send data	14-27
setup fields	14-30
alphanumeric keyboard	14-91

alternate rule sets	14-3
bar code list	14-5
bar code menu example	14-2
beep	14-47
code lengths	14-18
code types	14-11
criteria	14-1, 14-11
default rules	14-5
move cursor past a character	14-30
move cursor past specific string	14-30
move cursor to a character	14-30
move cursor to last occurrence	
of string and replace all	14-30
move cursor to specific	
string and replace	14-30
move cursor to start of data	14-30
numeric keypad	14-24, 14-25
pad spaces	14-38
pad zeros	14-42
rules	14-1
rules hierarchy	14-4
send alt characters	14-66
send control characters	14-47
send function key	14-76
send keyboard characters	14-52
send keypad characters	14-71
send preset value	14-31
send value	14-36
skip ahead "n" characters	14-31
skip ahead characters	14-33
skip back "n" characters	14-31
skip back characters	14-34
skip to end	14-30
space removal	14-37
special commands	14-8
specific data string	14-22
specific string	

- any location . . . . . 14-23
- any message ok . . . . . 14-23
- at start . . . . . 14-22
- rule belongs to set . . . . . 14-26
- turn off rule sets . . . . . 14-89, 14-90
- zero removal . . . . . 14-37
- ad-hoc . . . . . 2-45
- Ad-Hoc Channels . . . . . 2-46
- advanced data formatting . . . . . 14-1
- actions . . . . . 14-1, 14-27
- alphanumeric keyboard . . . . . 14-91
- alternate rule sets . . . . . 14-3
- bar code menu example . . . . . 14-2
- beep . . . . . 14-47
- code lengths . . . . . 14-18
- code types . . . . . 14-11
- criteria . . . . . 14-1, 14-11
- default rules . . . . . 14-5
- numeric keypad . . . . . 14-24, 14-25
- pad spaces . . . . . 14-38
- pad zeros . . . . . 14-42
- rules . . . . . 14-1
- rules hierarchy . . . . . 14-4
- send alt characters . . . . . 14-66
- send control characters . . . . . 14-47
- send function key . . . . . 14-76
- send keyboard characters . . . . . 14-52
- send keypad characters . . . . . 14-71
- send preset value . . . . . 14-36
- setup fields . . . . . 14-30
- skip ahead characters . . . . . 14-33
- skip back characters . . . . . 14-34
- space removal . . . . . 14-37
- special commands . . . . . 14-8
- specific data string . . . . . 14-22
- turn off rule sets . . . . . 14-89, 14-90
- zero removal . . . . . 14-37
- AIM code identifiers . . . . . B-3
- aiming options
  - hand-held decode aiming pattern . . . . . 5-17
  - snapshot aiming pattern . . . . . 6-6
  - snapshot mode timeout . . . . . 6-6
  - video view finder . . . . . 6-14
- aiming pattern . . . . . 3-4, 6-6
- enabling . . . . . 5-17
- orientation . . . . . 3-5, 3-6
- applications
  - BTE Explorer . . . . . 2-95
  - file explorer . . . . . 2-12, 2-104
  - image viewer . . . . . 2-11
  - MCL . . . . . 2-11
  - scan inventory . . . . . 2-11, 2-20, 2-26, 2-32, 2-37, 7-5, 7-6, G-4
  - scan item . . . . . 2-11, 2-17, 3-4, 7-5, 7-6, G-4

- scan-to-ip . . . . . 2-11
- simple inventory . . . . . 2-11
- startup . . . . . G-5
- startup default . . . . . 7-2
- ASCII values
  - keyboard wedge . . . . . 11-13
  - RS-232 . . . . . 8-19
  - USB . . . . . 9-20
- authentication . . . . . 4-2, 4-26, A-2
- authentication options . . . . . 2-49
- auto-reconnect . . . . . 4-4, 4-14, 4-20, 4-23

**B**

- bar code defaults
  - radio communication . . . . . 4-2
- bar codes
  - adaptive scanning . . . . . 5-9
  - ADF list . . . . . 14-5
  - Australia post format . . . . . 12-60
  - Australian postal . . . . . 12-59
  - authentication . . . . . 4-26
  - auto-reconnect in Bluetooth keyboard
    - emulation (HID slave) mode . . . . . 4-17
  - auto-reconnect interval . . . . . 4-14
  - aztec . . . . . 12-73
  - batch mode . . . . . 5-19
  - beep after good decode . . . . . 5-12
  - beeper tone . . . . . 5-13
  - beeper volume . . . . . 5-14
  - bluetooth friendly name . . . . . 4-7
  - Bluetooth technology support . . . . . 4-8
  - bookland EAN . . . . . 12-9
  - bookland ISBN . . . . . 12-21
  - cancel . . . . . D-3
  - Chinese 2 of 5 . . . . . 12-53
  - codabar . . . . . 12-46
  - codabar CLSI editing . . . . . 12-48
  - codabar lengths . . . . . 12-46
  - codabar NOTIS editing . . . . . 12-48
  - codabar start and stop characters . . . . . 12-49
  - code 11 . . . . . 12-36
  - code 11 lengths . . . . . 12-36
  - code 128 . . . . . 12-24
  - code 128 emulation . . . . . 12-70
  - code 128 lengths . . . . . 12-24
  - code 39 . . . . . 12-29
  - code 39 check digit verification . . . . . 12-32
  - code 39 full ASCII . . . . . 12-33
  - code 39 lengths . . . . . 12-31
  - code 39 transmit check digit . . . . . 12-32
  - code 93 . . . . . 12-34
  - code 93 lengths . . . . . 12-34
  - composite CC-A/B . . . . . 12-66

- composite CC-C . . . . . 12-66
- composite TLC-39 . . . . . 12-67
- connection maintenance interval . . . . . 4-23
- convert case . . . . . 4-13
- convert GS1 databar to UPC/EAN . . . . . 12-64
- convert UPC-E to UPC-A . . . . . 12-19
- convert UPC-E1 to UPC-A . . . . . 12-19
- coupon report . . . . . 12-22
- crop to address . . . . . 6-8
- data matrix . . . . . 12-71
- data options
  - pause duration . . . . . 14-8
- decode pager motor enable . . . . . 5-6
- decode session timeout . . . . . 5-15
- discoverable mode . . . . . 4-7
- discrete 2 of 5 . . . . . 12-43
  - lengths . . . . . 12-45
- DPM . . . . . 5-21
- EAN zero extend . . . . . 12-20
- EAN-13/JAN-13 . . . . . 12-9
- EAN-8/JAN-8 . . . . . 12-8
- emulate keypad . . . . . 4-11
- encryption . . . . . 4-28
- FIPS . . . . . 5-21
- FN1 substitution values . . . . . 5-25
- GS1 DataBar . . . . . 12-63
- GS1 databar expanded . . . . . 12-64
- GS1 DataBar limited . . . . . 12-63
- GS1 databar limited security level . . . . . 12-65
- GS1 databar-14 . . . . . 12-63
- GS1-128 . . . . . 12-26
- hand-held decode aiming pattern . . . . . 5-17
- HID CAPS lock override . . . . . 4-10
- HID country codes . . . . . 4-8
- HID function key mapping . . . . . 4-12
- HID ignore unknown characters . . . . . 4-11
- HID keyboard FN1 substitution . . . . . 4-12
- HID keyboard keystroke delay . . . . . 4-10
- host mode . . . . . 5-5
- I 2 of 5 check digit verification . . . . . 12-42
- I 2 of 5 convert to EAN-13 . . . . . 12-43
- I 2 of 5 transmit check digit . . . . . 12-42
- IBM 468X/469X
  - convert unknown to code 39 . . . . . 10-5
  - default parameters . . . . . 10-3
  - ignore configuration directive . . . . . 9-12
  - port address . . . . . 10-4
- illumination . . . . . 5-18, 6-5
- image brightness (target white) . . . . . 6-9
- image cropping . . . . . 6-7
- image file format . . . . . 6-10, 6-12
- imager scanner
  - default table . . . . . 6-2
- interleaved 2 of 5 . . . . . 12-39
  - convert to EAN-13 . . . . . 12-43
  - lengths . . . . . 12-40
- inverse 1D . . . . . 12-55
- ISBT 128 . . . . . 12-26
- ISBT concatenation . . . . . 12-27, 12-28
- ISBT concatenation redundancy . . . . . 12-28
- ISSN EAN . . . . . 12-23
- Japan postal . . . . . 12-58
- JPEG quality and size . . . . . 6-9
- keyboard wedge
  - alternate numeric keypad emulation . . . . . 11-8
  - caps lock on . . . . . 11-9
  - caps lock override . . . . . 11-9
  - country keyboard types (country codes) . . . . . 11-5
  - default table . . . . . 11-3
  - host types . . . . . 11-4
  - ignore unknown characters . . . . . 11-7
  - intra-keystroke delay . . . . . 11-8
  - keystroke delay . . . . . 11-7
- Korean 3 of 5 . . . . . 12-54
- korean 3 of 5 . . . . . 12-54
- lock override . . . . . 4-21
- maxicode . . . . . 12-71
- microPDF417 . . . . . 12-69
- microQR . . . . . 12-72
- MSI . . . . . 12-50
- MSI check digit algorithm . . . . . 12-53
- MSI check digits . . . . . 12-52
- MSI lengths . . . . . 12-50
- MSI transmit check digit . . . . . 12-52
- Netherlands KIX code . . . . . 12-61
- numeric bar codes . . . . . D-1
- pairing modes . . . . . 4-21
- parameter broadcast . . . . . 4-19
- parameter scanning . . . . . 5-7
- PDF417 . . . . . 12-68
- picklist modes . . . . . 5-16
- PIN code . . . . . 4-27
- postal . . . . . 12-56
- prefix/suffix values . . . . . 5-23
- QR code . . . . . 12-72
- radio communication . . . . . 4-4, 4-5
  - host types . . . . . 4-4, 4-5
  - pairing . . . . . 4-20
- radio output power . . . . . 4-19
- reconnect attempt beep . . . . . 4-14
- reconnect attempt interval . . . . . 4-15
- RS-232
  - baud rate . . . . . 8-7
  - beep on bel . . . . . 8-16
  - check receive errors . . . . . 8-11
  - data bits . . . . . 8-10
  - default table . . . . . 8-3
  - hardware handshaking . . . . . 8-11, 8-12

- host serial response time-out . . . . . 8-15
- host types . . . . . 8-6
- intercharacter delay . . . . . 8-17
- parity . . . . . 8-9
- RTS line state . . . . . 8-16
- software handshaking . . . . . 8-13, 8-14
- stop bit select . . . . . 8-10, 8-16
- sample . . . . . C-1
- scan angle . . . . . 5-8
- scan data options . . . . . 5-24
- scanner to cradle support . . . . . 4-19
- set defaults . . . . . 5-4
- signature capture . . . . . 6-11
- signature capture height . . . . . 6-13
- signature capture JPEG quality . . . . . 6-13
- signature capture width . . . . . 6-13
- simulated caps lock . . . . . 4-13
- snapshot aiming pattern . . . . . 6-6
- snapshot mode timeout . . . . . 6-6
- supplementals . . . . . 12-10
- symbolologies
  - default table . . . . . 12-2
- timeout between decodes, same symbol . . . . . 5-17
- transmit code ID character . . . . . 5-22
- transmit no read message . . . . . 5-26
- transmit UK postal check digit . . . . . 12-58
- transmit US postal check digit . . . . . 12-57
- trigger mode, hand held . . . . . 5-15
- UCC coupon extended code . . . . . 12-22
- UK postal . . . . . 12-57
- unpair . . . . . 4-22
- UPC composite mode . . . . . 12-67
- UPC/EAN
  - coupon code . . . . . 12-22
  - supp redundancy . . . . . 12-13, 12-14
- UPC/EAN/JAN
  - supplemental AIM ID format . . . . . 12-14
  - supplemental redundancy . . . . . 12-13
- UPC-A . . . . . 12-7
- UPC-A preamble . . . . . 12-16
- UPC-A/E/E1 check digit . . . . . 12-14, 12-15, 12-16
- UPC-E . . . . . 12-7
- UPC-E preamble . . . . . 12-17
- UPC-E1 . . . . . 12-8
- UPU FICS postal . . . . . 12-62
- US planet . . . . . 12-56
- US postnet . . . . . 12-56
- USB
  - caps lock override . . . . . 9-10
  - country keyboard types . . . . . 9-8
  - default table . . . . . 9-3
  - device type . . . . . 9-5
  - fast HID keyboard . . . . . 9-18
  - HID over STB2000 charge-only cradle . . . . . 9-19

- ignore beep directive . . . . . 9-11
- keystroke delay . . . . . 9-10
- polling interval . . . . . 9-16, 9-17
- quick keypad emulation . . . . . 9-18
- SNAPI handshaking . . . . . 9-7
- unknown characters . . . . . 9-11
- USPS 4CB/One Code/Intelligent Mail . . . . . 12-61
- variable PIN code . . . . . 4-27
- video view finder . . . . . 6-14
- batch mode . . . . . 5-19
- battery
  - charging . . . . . 1-13
  - inserting . . . . . 1-11
  - power . . . . . 1-11, 13-3
  - spare . . . . . 1-18
- battery removal . . . . . 1-18
- battery usage options . . . . . 2-69
- beeper definitions . . . . . 3-1
  - pairing . . . . . 4-3
  - wireless . . . . . 4-3
- Bluetooth . . . . . 1-16
  - add service . . . . . 2-97
  - address . . . . . 2-15
  - authentication . . . . . 4-26
  - BTE Explorer . . . . . 2-95
  - cradle . . . . . 1-2, 13-4
  - encryption . . . . . 4-26
  - establish connection . . . . . G-3, G-4
  - icon on device . . . . . 2-10
  - pairing bar code . . . . . 1-4, 4-23
  - profiles . . . . . 4-4, 4-6
  - radio communications . . . . . 1-16
  - scanner services, disabling . . . . . 7-6, G-5
  - security . . . . . 4-26
  - send data to host . . . . . 1-16
- bluetooth
  - ad-hoc mode . . . . . 2-45
- Bluetooth cradle . . . . . 13-1
- bluetooth keyboard emulation . . . . . 4-4
- bullets . . . . . xxii

## C

- cables
  - installing . . . . . 1-11
- cache options . . . . . 2-58
- character sets
  - keyboard wedge . . . . . 11-13
  - RS-232 . . . . . 8-19
  - USB . . . . . 9-20
- charging . . . . . 1-13
  - LEDs . . . . . 1-13
  - spare batteries . . . . . 1-18
  - via USB . . . . . 1-12, 15-5

- charging spare batteries . . . . . 1-18
  - cleaning . . . . . 15-1, 15-2
  - codabar bar codes
    - CLSI editing . . . . . 12-48
    - codabar . . . . . 12-46
    - lengths . . . . . 12-46
    - NOTIS editing . . . . . 12-48
    - start and stop characters . . . . . 12-49
  - code 11 bar codes
    - code 11 . . . . . 12-36
    - lengths . . . . . 12-36
  - code 128 bar codes
    - code 128 . . . . . 12-24
    - GS1-128 . . . . . 12-26
    - ISBT 128 . . . . . 12-26
    - ISBT concatenation . . . . . 12-27, 12-28
    - ISBT concatenation redundancy . . . . . 12-28
    - lengths . . . . . 12-24
  - code 128 emulation bar codes . . . . . 12-70
  - code 39 bar codes
    - check digit verification . . . . . 12-32
    - code 39 . . . . . 12-29
    - full ASCII . . . . . 12-33
    - lengths . . . . . 12-31
    - transmit check digit . . . . . 12-32
  - code 93 bar codes
    - code 93 . . . . . 12-34
    - lengths . . . . . 12-34
  - code ID character . . . . . 5-22
  - code identifiers
    - AIM code identifiers . . . . . B-3
    - modifier characters . . . . . B-4
    - Symbol code identifiers . . . . . B-1
  - code types
    - ADF . . . . . 14-11
  - cold boot . . . . . 1-17
  - composite bar codes
    - composite CC-A/B . . . . . 12-66
    - composite CC-C . . . . . 12-66
    - composite TLC-39 . . . . . 12-67
    - UPC composite mode . . . . . 12-67
  - configuring scanner . . . . . 1-13
  - connecting
    - IBM 468X/469X interface . . . . . 10-2
    - keyboard wedge interface . . . . . 11-2
    - lost connection . . . . . 1-16
    - RS-232 interface . . . . . 8-2
    - USB interface . . . . . 9-2
  - contents . . . . . 1-1
  - conventions
    - notational . . . . . xxii
  - country code . . . . . 2-45
  - coupon report . . . . . 12-22
  - cradle
    - connecting . . . . . 1-11
    - diagram . . . . . 1-4, 1-5, 1-6, 1-7, 1-8, 1-9
    - inserting scanner . . . . . 1-13
    - removing scanner . . . . . 1-13, 13-6
    - supply power . . . . . 1-12
  - cradles
    - Ethernet cradle . . . . . 13-2
    - four slot . . . . . 13-1, 13-2, 13-6
    - four slot battery charger . . . . . 13-2
    - four slot USB . . . . . 13-8
    - single slot . . . . . 13-1, 13-2, 13-3
      - LED indicators . . . . . 13-5
    - single slot multi-interface Bluetooth cradle . . . . . 13-1
    - USB cradle . . . . . 13-1, 13-2
  - cropping . . . . . 6-7, 6-8
- ## D
- data matrix bar codes . . . . . 12-71
  - decode distances
    - MT2070/2090-HD High Density Imager . . . . . 3-10
    - MT2070/2090-ML laser . . . . . 3-9
    - MT2070/2090-SD Imager . . . . . 3-10
    - MT2070/2090-SL laser . . . . . 3-9
  - default parameters
    - IBM 468X/469X . . . . . 10-3
    - imaging preferences . . . . . 6-2
    - keyboard wedge . . . . . 11-3
    - radio communication . . . . . 4-2
    - RS-232 . . . . . 8-3
    - standard default table . . . . . A-1
    - symbologies . . . . . 12-2
    - USB . . . . . 9-3
    - user preferences . . . . . 5-2
  - direct part marking . . . . . 3-5
    - scanning . . . . . 3-5
  - discrete 2 of 5 bar codes
    - discrete 2 of 5 . . . . . 12-43
  - DPM . . . . . 3-5, 5-21
    - scanning . . . . . 3-5
- ## E
- encryption . . . . . 4-2, 4-28, A-2
  - encryption options . . . . . 2-61
  - encryption/authentication matrix . . . . . 2-61
  - error indications
    - miscellaneous scanner options . . . . . 4-1
  - ESD dongle . . . . . 1-1, 2-102, 9-2, 13-1, G-2
  - Ethernet cradle . . . . . 13-2
  - exercises . . . . . G-1
  - exposure options
    - illumination . . . . . 5-18, 6-5



**F**

FIPS	5-21
forklift cradle	13-1
four slot battery charger	13-2
four slot cradle	13-1
four slot cradles	13-6
Ethernet charge only	13-2
USB charge only	13-1
four slot Ethernet cradle	13-2
four slot USB cradle	13-8

**G**

GS1 DataBar	12-63
GS1 databar	
convert GS1 databar to UPC/EAN	12-64
GS1 databar expanded	12-64
GS1 databar limited	12-63
GS1 databar limited security level	12-65
GS1 databar-14	12-63
guides	
integrator guide	xxiii
quick start guide	xxiii
user guide	xxiii

**H**

HID keyboard	9-18
HID Profile	4-6
HID slave	4-4
host types	
keyboard wedge	11-4
RS-232	8-6

**I**

IBM 468X/469X	
connection	10-2
default parameters	10-3
parameters	10-4
icons	
battery	2-9
connection	2-10
keypad functionality	2-10
profile	2-43
signal strength	2-83
wireless signal	2-10
ID	4-10
illumination	5-18, 6-5
image brightness (target white)	6-9
image cropping	6-7, 6-8
image options	
cropping	6-7, 6-8

file formats	6-10, 6-12
image brightness (target white)	6-9
JPEG size/quality	6-9
imager scanner	
defaults	6-2
imaging preferences parameters	6-2
infrastructure	2-45
installation, battery	1-11
IntelliStand	3-7, 13-2
interfaces supported	
via communication with a cradle	1-10
via communication without cradle	1-10
interleaved 2 of 5 bar codes	
check digit verification	12-42
convert to EAN-13	12-43
transmit check digit	12-42

**J**

JPEG image options	
size/quality	6-9

**K**

keyboard wedge	
connection	11-2
default parameters	11-3
parameters	11-4
keypad functionality	2-3
keypad mapping	4-12, 9-14, 11-10
keypad multi-tap configuration	2-7
Korean 3 of 5 bar codes	12-54

**L**

LED	
charging	1-13
LED definitions	3-3
LED indicators	
miscellaneous information	13-5
single slot charge only	13-5
single slot multi-interface	13-5
lock override	4-21
locked pairing mode	4-21, 4-23
low power mode	4-14

**M**

maintenance	15-1
master	4-4, 4-6, 4-14, 4-20
maxicode bar codes	12-71
MCL	
delete last	2-38
scan inventory	2-37



scan transmit	2-36
send data	2-38
start up guide	2-35
view data	2-38
microPDF417 bar codes	12-69
mode	
ad-hoc	2-45
country	2-45
infrastructure	2-45
operating	2-45
mounting	
intellistand	3-7
MSI bar codes	
check digit algorithm	12-53
check digits	12-52
lengths	12-50
MSI	12-50
transmit check digit	12-52
multipoint-to-point communication	4-19

## N

notational conventions	xxii
------------------------	------

## O

operating mode	2-45
out of range indicator	4-18

## P

pairing	1-16
address	4-14
bar code	4-3
bar code format	4-23
beeper definitions	4-3
connection maintenance interval	4-23
cradle host	4-4
lock override	4-21
master/slave setup	4-6
methods	4-22
modes	4-2, 4-20, A-2
multipoint-to-point	4-19
on contacts	4-2, A-2
pin codes	4-27
point-to-point	4-19
radio communication	1-16
SPP	4-4
unpair	4-22
parameter defaults	
radio communication	4-2
parameters	
decode pager motor enable	5-6
default	5-4

host mode	5-5
PDF417 bar codes	12-68
PIN code	4-27
static	4-27
variable	4-27
point-to-point communication	4-19
postal codes	12-56
Australia post format	12-60
Australian postal	12-59
Japan postal	12-58
Netherlands KIX code	12-61
transmit UK postal check digit	12-58
transmit US postal check digit	12-57
UK postal	12-57
UPU FICS postal	12-62
US planet	12-56
US postnet	12-56
USPS 4CB/One Code/Intelligent Mail	12-61
power	1-12
via USB	1-12, 15-5

## Q

QR code bar codes	12-72
quick keypad emulation	9-18

## R

radio communication	
bar codes	4-4, 4-5
Bluetooth Technology Profile support	1-16
defaults	4-2
multipoint-to-point	4-19
pairing	1-16
point-to-point	4-19
reconnect attempt	4-15
reconnect attempt beep	4-14
range indicator	4-18
reconnect attempt	4-15
beep	4-14
remove Li-ion battery	1-18
removing scanner from cradle	1-13, 13-6
resetting the scanner	1-17
RS-232	
connection	8-2
default parameters	8-3
parameters	8-4, 8-6

## S

sample bar codes	C-1
scanner	
cold boot	1-17
starting	1-17

scanner services, disabling . . . . . 7-6, G-5

scanner to cradle support . . . . . 4-19

scanning

- aiming . . . . . 3-4
- angle . . . . . 3-8
- errors . . . . . 5-2, 6-2, 12-2
- hand-held . . . . . 3-4
- presentation mode . . . . . 3-7
- radio communications sequence example . . . . . 4-1
- range . . . . . 3-8
- sequence example . . . . . 5-2, 6-2, 12-1

screens

- home . . . . . 2-11

security modes . . . . . 2-48

Serial Port Profile . . . . . 4-6

- master . . . . . 4-4, 4-14, 4-20
- slave . . . . . 4-4

service information . . . . . xxiii

setup

- connecting a USB interface . . . . . 9-2
- connecting an RS-232 interface . . . . . 8-2
- connecting keyboard wedge interface . . . . . 11-2
- connecting to an IBM 468X/469X host . . . . . 10-2
- inserting scanner in cradle . . . . . 1-13
- installing the cable . . . . . 1-11
- lost host connection . . . . . 1-16
- removing scanner from cradle . . . . . 1-13, 13-6
- supplying power . . . . . 1-12

signature capture . . . . . 6-11

- file format selector . . . . . 6-12
- height . . . . . 6-13
- JPEG quality . . . . . 6-13
- width . . . . . 6-13

single slot cradle

- LED indicators . . . . . 13-5

single slot cradles . . . . . 13-3

- multi-interface/Bluetooth . . . . . 13-1
- USB charge only . . . . . 13-1

single slot forklift cradle . . . . . 13-1

single slot multi-interface cradle . . . . . 13-1

single slot USB cradle . . . . . 13-2

slave . . . . . 4-4, 4-6

snapshot mode timeout . . . . . 6-6

spare batteries

- charging . . . . . 1-18

spare battery

- charging . . . . . 1-18

spare battery charger . . . . . 13-2

SPP . . . . . 4-6

- master . . . . . 4-4, 4-14, 4-20
- slave . . . . . 4-4

standard default parameters . . . . . A-1

starting the scanner . . . . . 1-17

support . . . . . xxiii

suspend . . . . . 1-17, 1-18

Symbol code identifiers . . . . . B-1

symbology default parameters . . . . . 12-2

**T**

troubleshooting . . . . . 15-3

tunneled authentication options . . . . . 2-50

**U**

unlocked pairing mode . . . . . 4-21

unpacking

- scanner . . . . . 1-1

unpairing

- bar codes . . . . . 4-22

UPC/EAN bar codes

- bookland EAN . . . . . 12-9
- bookland ISBN . . . . . 12-21
- check digit . . . . . 12-14, 12-15, 12-16
- convert UPC-E to UPC-A . . . . . 12-19
- convert UPC-E1 to UPC-A . . . . . 12-19
- EAN zero extend . . . . . 12-20
- EAN-13/JAN-13 . . . . . 12-9
- EAN-8/JAN-8 . . . . . 12-8
- ISSN EAN . . . . . 12-23
- supplementals . . . . . 12-10
- UCC coupon extended code . . . . . 12-22
- UPC-A . . . . . 12-7
- UPC-A preamble . . . . . 12-16
- UPC-E . . . . . 12-7
- UPC-E preamble . . . . . 12-17
- UPC-E1 . . . . . 12-8

**USB**

- connection . . . . . 9-2
- default parameters . . . . . 9-3
- parameters . . . . . 9-5

USB cradle . . . . . 13-1, 13-2

USB HID over STB2000

- charge-only cradle . . . . . 9-19
- USB polling interval . . . . . 9-16, 9-17
- user preferences parameters . . . . . 5-2

**V**

video view finder . . . . . 6-14

**W**

wireless companion . . . . . 2-41

**Z**

Zebra support . . . . . xxiii





# Glossary

---

## A

**Aperture.** The opening in an optical system defined by a lens or baffle that establishes the field of view.

**ASCII.** American Standard Code for Information Interchange. A 7 bit-plus-parity code representing 128 letters, numerals, punctuation marks and control characters. It is a standard data transmission code in the U.S.

**Autodiscrimination.** The ability of an interface controller to determine the code type of a scanned bar code. After this determination is made, the information content is decoded.

---

## B

**Bar.** The dark element in a printed bar code symbol.

**Bar Code.** A pattern of variable-width bars and spaces which represents numeric or alphanumeric data in machine-readable form. The general format of a bar code symbol consists of a leading margin, start character, data or message character, check character (if any), stop character, and trailing margin. Within this framework, each recognizable symbology uses its own unique format. See **Symbology**.

**Bar Code Density.** The number of characters represented per unit of measurement (e.g., characters per inch).

**Bar Height.** The dimension of a bar measured perpendicular to the bar width.

**Bar Width.** Thickness of a bar measured from the edge closest to the symbol start character to the trailing edge of the same bar.

**Bit.** Binary digit. One bit is the basic unit of binary information. Generally, eight consecutive bits compose one byte of data. The pattern of 0 and 1 values within the byte determines its meaning.

**Bits per Second (bps).** Bits transmitted or received.

**Bluetooth.** A technology that provides a way to connect and exchange information between devices such as scanners, mobile phones, laptops, PCs, and printers over a secure, globally unlicensed short-range radio frequency.

**Boot or Boot-up.** The process a computer goes through when it starts. During boot-up, the computer can run self-diagnostic tests and configure hardware and software.

**bps.** See **Bits Per Second**.

**Byte.** On an addressable boundary, eight adjacent binary digits (0 and 1) combined in a pattern to represent a specific character or numeric value. Bits are numbered from the right, 0 through 7, with bit 0 the low-order bit. One byte in memory is used to store one ASCII character.

---

## C

**CDRH.** Center for Devices and Radiological Health. A federal agency responsible for regulating laser product safety. This agency specifies various laser operation classes based on power output during operation.

**CDRH Class 1.** This is the lowest power CDRH laser classification. This class is considered intrinsically safe, even if all laser output were directed into the eye's pupil. There are no special operating procedures for this class.

**CDRH Class 2.** No additional software mechanisms are needed to conform to this limit. Laser operation in this class poses no danger for unintentional direct human exposure.

**Character.** A pattern of bars and spaces which either directly represents data or indicates a control function, such as a number, letter, punctuation mark, or communications control contained in a message.

**Character Set.** Those characters available for encoding in a particular bar code symbology.

**Check Digit.** A digit used to verify a correct symbol decode. The scanner inserts the decoded data into an arithmetic formula and checks that the resulting number matches the encoded check digit. Check digits are required for UPC but are optional for other symbologies. Using check digits decreases the chance of substitution errors when a symbol is decoded.

**Codabar.** A discrete self-checking code with a character set consisting of digits 0 to 9 and six additional characters: ( - \$ : / , +).

**Code 128.** A high density symbology which allows the controller to encode all 128 ASCII characters without adding extra symbol elements.

**Code 3 of 9 (Code 39).** A versatile and widely used alphanumeric bar code symbology with a set of 43 character types, including all uppercase letters, numerals from 0 to 9 and 7 special characters (- . / + % \$ and space). The code name is derived from the fact that 3 of 9 elements representing a character are wide, while the remaining 6 are narrow.

**Code 93.** An industrial symbology compatible with Code 39 but offering a full character ASCII set and a higher coding density than Code 39.

**Code Length.** Number of data characters in a bar code between the start and stop characters, not including those characters.

**Cold Boot.** A cold boot restarts a computer and closes all running programs.

**COM Port.** Communication port; ports are identified by number, e.g., COM1, COM2.

**Continuous Code.** A bar code or symbol in which all spaces within the symbol are parts of characters. There are no intercharacter gaps in a continuous code. The absence of gaps allows for greater information density.

**Cradle.** A cradle is used for charging the terminal battery and for communicating with a host computer, and provides a storage place for the terminal when not in use.

---

## D

**Dead Zone.** An area within a scanner's field of view, in which specular reflection may prevent a successful decode.

**Decode.** To recognize a bar code symbology (e.g., UPC/EAN) and then analyze the content of the specific bar code scanned.

**Decode Algorithm.** A decoding scheme that converts pulse widths into data representation of the letters or numbers encoded within a bar code symbol.

**Decryption.** Decryption is the decoding and unscrambling of received encrypted data. Also see, **Encryption** and **Key**.

**Depth of Field.** The range between minimum and maximum distances at which a scanner can read a symbol with a certain minimum element width.

**Discrete Code.** A bar code or symbol in which the spaces between characters (intercharacter gaps) are not part of the code.

**Discrete 2 of 5.** A binary bar code symbology representing each character by a group of five bars, two of which are wide. The location of wide bars in the group determines which character is encoded; spaces are insignificant. Only numeric characters (0 to 9) and START/STOP characters may be encoded.

---

## E

**EAN.** European Article Number. This European/International version of the UPC provides its own coding format and symbology standards. Element dimensions are specified metrically. EAN is used primarily in retail.

**Element.** Generic term for a bar or space.

**Encoded Area.** Total linear dimension occupied by all characters of a code pattern, including start/stop characters and data.

**ENQ (RS-232).** ENQ software handshaking is also supported for the data sent to the host.

**ESD.** Electro-Static Discharge

---

## H

**HID.** Human Interface Device. A Bluetooth host type.

**Host Computer.** A computer that serves other terminals in a network, providing such services as computation, database access, supervisory programs and network control.

**Hz.** Hertz; A unit of frequency equal to one cycle per second.

---

## I

**IEC.** International Electrotechnical Commission. This international agency regulates laser safety by specifying various laser operation classes based on power output during operation.

**IEC (825) Class 1.** This is the lowest power IEC laser classification. Conformity is ensured through a software restriction of 120 seconds of laser operation within any 1000 second window and an automatic laser shutdown if the scanner's oscillating mirror fails.

**Intercharacter Gap.** The space between two adjacent bar code characters in a discrete code.

**Interleaved 2 of 5.** A binary bar code symbology representing character pairs in groups of five bars and five interleaved spaces. Interleaving provides for greater information density. The location of wide elements (bar/spaces) within each group determines which characters are encoded. This continuous code type uses no intercharacter spaces. Only numeric (0 to 9) and START/STOP characters may be encoded.

**Interleaved Bar Code.** A bar code in which characters are paired together, using bars to represent the first character and the intervening spaces to represent the second.

**Input/Output Ports.** I/O ports are primarily dedicated to passing information into or out of the terminal's memory. Series 9000 mobile computers include Serial and USB ports.

**I/O Ports.** interface The connection between two devices, defined by common physical characteristics, signal characteristics, and signal meanings. Types of interfaces include RS-232 and PCMCIA.

---

## K

**Key.** A key is the specific code used by the algorithm to encrypt or decrypt the data. Also see, **Encryption** and **Decrypting**.

---

## L

**LASER.** Light Amplification by Stimulated Emission of Radiation. The laser is an intense light source. Light from a laser is all the same frequency, unlike the output of an incandescent bulb. Laser light is typically coherent and has a high energy density.

**Laser Diode.** A gallium-arsenide semiconductor type of laser connected to a power source to generate a laser beam. This laser type is a compact source of coherent light.

**Laser Scanner.** A type of bar code reader that uses a beam of laser light.

**LED Indicator.** A semiconductor diode (LED - Light Emitting Diode) used as an indicator, often in digital displays. The semiconductor uses applied voltage to produce light of a certain frequency determined by the semiconductor's particular chemical composition.



**Light Emitting Diode.** See **LED**.

---

## M

**MIL.** 1 mil = 1 thousandth of an inch.

**MIN.** Mobile Identification Number. The unique account number associated with a cellular device. It is broadcast by the cellular device when accessing the cellular system.

**Misread (Misdecode).** A condition which occurs when the data output of a reader or interface controller does not agree with the data encoded within a bar code symbol.

**MRD.** Minimum reflective difference. A measurement of print contrast.

---

## N

**Nominal.** The exact (or ideal) intended value for a specified parameter. Tolerances are specified as positive and negative deviations from this value.

**Nominal Size.** Standard size for a bar code symbol. Most UPC/EAN codes are used over a range of magnifications (e.g., from 0.80 to 2.00 of nominal).

---

## O

**ODI.** See **Open Data-Link Interface**.

**Open Data-Link Interface (ODI).** Novell's driver specification for an interface between network hardware and higher-level protocols. It supports multiple protocols on a single NIC (Network Interface Controller). It is capable of understanding and translating any network information or request sent by any other ODI-compatible protocol into something a NetWare client can understand and process.

**Open System Authentication.** Open System authentication is a null authentication algorithm.

---

## P

**PAN .** Personal area network. Using Bluetooth wireless technology, PANs enable devices to communicate wirelessly. Generally, a wireless PAN consists of a dynamic group of less than 255 devices that communicate within about a 33-foot range. Only devices within this limited area typically participate in the network.

**Parameter.** A variable that can have different values assigned to it.

**Percent Decode.** The average probability that a single scan of a bar code would result in a successful decode. In a well-designed bar code scanning system, that probability should approach near 100%.

**Print Contrast Signal (PCS).** Measurement of the contrast (brightness difference) between the bars and spaces of a symbol. A minimum PCS value is needed for a bar code symbol to be scannable.  $PCS = (RL - RD) / RL$ , where RL is the reflectance factor of the background and RD the reflectance factor of the dark bars.

**Programming Mode.** The state in which a scanner is configured for parameter values. See **Scanning Mode**.

---

## Q

**Quiet Zone.** A clear space, containing no dark marks, which precedes the start character of a bar code symbol and follows the stop character.

**QWERTY.** A standard keyboard commonly used on North American and some European PC keyboards. "QWERTY" refers to the arrangement of keys on the left side of the third row of keys.

---

## R

**Reflectance.** Amount of light returned from an illuminated surface.

**Resolution.** The narrowest element dimension which is distinguished by a particular reading device or printed with a particular device or method.

**RF.** Radio Frequency.

**RS-232.** An Electronic Industries Association (EIA) standard that defines the connector, connector pins, and signals used to transfer data serially from one device to another.

---

## S

**Scan Area.** Area intended to contain a symbol.

**Scanner.** An electronic device used to scan bar code symbols and produce a digitized pattern that corresponds to the bars and spaces of the symbol. Its three main components are: 1) Light source (laser or photoelectric cell) - illuminates a bar code;; 2) Photodetector - registers the difference in reflected light (more light reflected from spaces); 3) Signal conditioning circuit - transforms optical detector output into a digitized bar pattern.

**Scanning Mode.** The scanner is energized, programmed and ready to read a bar code.

**Scanning Sequence.** A method of programming or configuring parameters for a bar code reading system by scanning bar code menus.

**Self-Checking Code.** A symbology that uses a checking algorithm to detect encoding errors within the characters of a bar code symbol.

**Space.** The lighter element of a bar code formed by the background between bars.

**Specular Reflection.** The mirror-like direct reflection of light from a surface, which can cause difficulty decoding a bar code.

**SPP.** Serial Port Profile.

**Start/Stop Character.** A pattern of bars and spaces that provides the scanner with start and stop reading instructions and scanning direction. The start and stop characters are normally to the left and right margins of a horizontal code.

**Substrate.** A foundation material on which a substance or image is placed.

**Symbol.** A scannable unit that encodes data within the conventions of a certain symbology, usually including start/stop characters, quiet zones, data characters and check characters.

**Symbol Aspect Ratio.** The ratio of symbol height to symbol width.

**Symbol Height.** The distance between the outside edges of the quiet zones of the first row and the last row.

**Symbol Length.** Length of symbol measured from the beginning of the quiet zone (margin) adjacent to the start character to the end of the quiet zone (margin) adjacent to a stop character.

**Symbology.** The structural rules and conventions for representing data within a particular bar code type (e.g. UPC/EAN, Code 39, PDF417, etc.).

---

## T

**Tolerance.** Allowable deviation from the nominal bar or space width.

---

## U

**UPC.** Universal Product Code. A relatively complex numeric symbology. Each character consists of two bars and two spaces, each of which is any of four widths. The standard symbology for retail food packages in the United States.

---

## V

**Visible Laser Diode (VLD).** A solid state device which produces visible laser light.



# *Tell Us What You Think...*

We'd like to know what you think about this Manual. Please take a moment to fill out this questionnaire and fax this form to: (631) 627-7184, or mail to:

Zebra Technologies Corporation  
Lincolnshire, IL U.S.A.  
<http://www.zebra.com>  
Attention: Technical Publications Manager  
Data Capture Solutions

**IMPORTANT:** If you need product support, please call the appropriate customer support number provided. Unfortunately, we cannot provide customer support at the fax number above.

Manual Title: \_\_\_\_\_  
(please include revision level)

How familiar were you with this product before using this manual?

- Very familiar     Slightly familiar     Not at all familiar

Did this manual meet your needs? If not, please explain.

---

---

---

What topics need to be added to the index, if applicable?

---

---

---

What topics do you feel need to be better discussed? Please be specific.

---

---

---

What can we do to further improve our manuals?

---

---

---

Thank you for your input—We value your comments.







**Zebra Technologies Corporation**  
Lincolnshire, IL U.S.A.  
<http://www.zebra.com>

**Zebra and the Zebra head graphic are registered trademarks of ZIH Corp. The Symbol logo is a registered trademark of Symbol Technologies, Inc., a Zebra Technologies company.**

**© 2015 Symbol Technologies, Inc.**



**72E-117859-08 Revision A March 2015**