

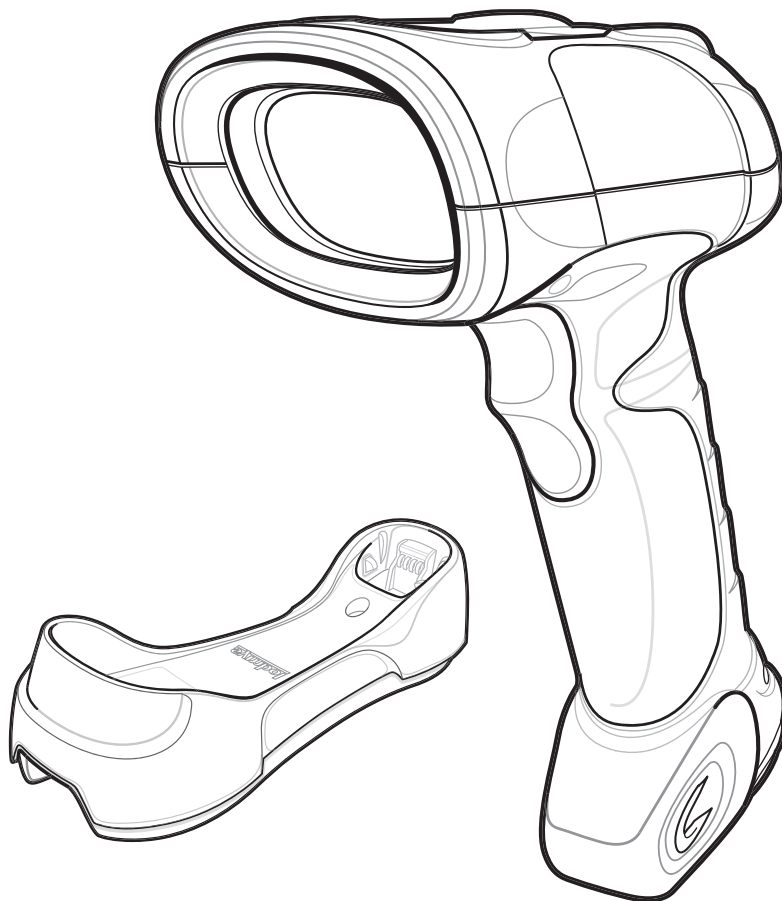

LS3578

Product Reference Guide



LS3578
Product Reference Guide

72E-93911-03
Revision A
November 2012

© Motorola Solutions, Inc. All rights reserved.

No part of this publication may be reproduced or used in any form, or by any electrical or mechanical means, without permission in writing from Motorola. This includes electronic or mechanical means, such as photocopying, recording, or information storage and retrieval systems. The material in this manual is subject to change without notice.

The software is provided strictly on an “as is” basis. All software, including firmware, furnished to the user is on a licensed basis. Motorola grants to the user a non-transferable and non-exclusive license to use each software or firmware program delivered hereunder (licensed program). Except as noted below, such license may not be assigned, sublicensed, or otherwise transferred by the user without prior written consent of Motorola. No right to copy a licensed program in whole or in part is granted, except as permitted under copyright law. The user shall not modify, merge, or incorporate any form or portion of a licensed program with other program material, create a derivative work from a licensed program, or use a licensed program in a network without written permission from Motorola. The user agrees to maintain Motorola’s copyright notice on the licensed programs delivered hereunder, and to include the same on any authorized copies it makes, in whole or in part. The user agrees not to decompile, disassemble, decode, or reverse engineer any licensed program delivered to the user or any portion thereof.

Motorola reserves the right to make changes to any software or product to improve reliability, function, or design.

Motorola does not assume any product liability arising out of, or in connection with, the application or use of any product, circuit, or application described herein.

No license is granted, either expressly or by implication, estoppel, or otherwise under any Motorola, Inc., intellectual property rights. An implied license only exists for equipment, circuits, and subsystems contained in Motorola products.

MOTOROLA, MOTO, MOTOROLA SOLUTIONS and the Stylized M Logo are trademarks or registered trademarks of Motorola Trademark Holdings, LLC and are used under license. All other trademarks are the property of their respective owners.

Motorola Solutions, Inc.
One Motorola Plaza
Holtsville, New York 11742-1300
<http://www.motorolasolutions.com>

Warranty

For the complete Motorola Solutions hardware product warranty statement, go to:

<http://www.motorola.com/enterprisemobility/warranty>

Revision History

Changes to the original manual are listed below:

Change	Date	Description
-01 Rev A	5/2007	Initial release.
-02 Rev A	4/2008	Remove HID Profile (Master) option, add Discoverable Mode parameter, update Auto-reconnect in Bluetooth Keyboard Emulation (HID Slave) Mode options, update Pairing Mode information, add French Belgian country codes.
-03 Rev A	11/2012	Update: URLs; ambient light tolerance; service information; Feedback page fax number Remove: Patent statement; "Symbol" brand name; link to www.symbol.com/usb ; motion art from back cover.

Table of Contents

Warranty	ii
Revision History	iii

About This Guide

Introduction	xiii
Chapter Descriptions	xiii
Notational Conventions	xiv
Related Documents	xv
Service Information	xv

Chapter 1: Getting Started

Introduction	1-1
Unpacking the Scanner	1-2
The Cradle	1-2
Cradle Parts	1-3
Connecting the Cradle	1-4
Supplying Power to the Cradle	1-6
Connecting a Synapse Cable Interface	1-6
Mounting the Cradle	1-6
Inserting the Battery	1-7
Removing the Battery	1-8
Charging the Scanner Battery in the Cradle	1-8
Scanner Charging LED	1-8
Inserting the Scanner in the Cradle	1-9
Sending Data to the Host Computer	1-10
Pairing	1-10
Lost Connection to Host	1-10
Configuring the Scanner	1-10
Radio Communications	1-10

Chapter 2: Scanning

Introduction	2-1
Beeper Definitions	2-1
LED Definitions	2-4
Scanning	2-5
Aiming	2-6
Decode Zone	2-7

Chapter 3: Maintenance and Technical Specifications

Introduction	3-1
Maintenance	3-1
Battery Maintenance	3-1
Troubleshooting	3-2
Technical Specifications	3-5
Scanner Signal Descriptions	3-7

Chapter 4: Radio Communications

Introduction	4-1
Scanning Sequence Examples	4-1
Errors While Scanning	4-1
Radio Communications Parameter Defaults	4-2
Wireless Beeper Definitions	4-3
Radio Communications Host Types	4-4
Bluetooth Technology Profile Support	4-6
Master/Slave Set Up	4-6
Bluetooth Friendly Name	4-7
Discoverable Mode	4-7
HID Host Parameters	4-8
HID Country Keyboard Types (Country Codes)	4-9
HID Keyboard Keystroke Delay	4-11
HID CAPS Lock Override	4-11
HID Ignore Unknown Characters	4-12
Emulate Keypad	4-12
HID Keyboard FN1 Substitution	4-13
HID Function Key Mapping	4-13
Simulated Caps Lock	4-14
Convert Case	4-14
Auto-reconnect Feature	4-15
Reconnect Attempt Beep Feedback	4-15
Reconnect Attempt Interval	4-16
Auto-reconnect in Bluetooth Keyboard Emulation (HID Slave) Mode	4-18
Out of Range Indicator	4-19
Scanner(s) To Cradle Support	4-20
Modes of Operation	4-20
Parameter Broadcast (Cradle Host Only)	4-21
Pairing	4-21
Pairing Bar Code Format	4-24
Connection Maintenance Interval	4-24

Bluetooth Security	4-27
Authentication	4-27
PIN Code	4-28
Encryption	4-29

Chapter 5: User Preferences

Introduction	5-1
Scanning Sequence Examples	5-2
Errors While Scanning	5-2
User Preferences Default Parameters	5-2
User Preferences	5-4
Default Parameters	5-4
Beeper Tone	5-5
Beeper Volume	5-6
Laser On Time	5-7
Beep After Good Decode	5-7
Trigger Mode	5-8
Aim Duration	5-9
Beep on Insertion	5-9
Time Delay to Reduced Power Mode	5-10
Transmit Code ID Character	5-11
Scan Angle	5-11
Prefix/Suffix Values	5-12
Scan Data Transmission Format	5-13
FN1 Substitution Values	5-15
Transmit “No Read” Message	5-15
Synapse Interface	5-16
Batch Mode	5-17
Report Scanner Version	5-19
Report Scan Engine Version	5-19
Report MIMIC Version	5-19
Report Synapse Cable	5-19

Chapter 6: Keyboard Wedge Interface

Introduction	6-1
Connecting a Keyboard Wedge Interface	6-2
Keyboard Wedge Default Parameters	6-3
Keyboard Wedge Host Types	6-4
Keyboard Wedge Host Types	6-4
Keyboard Wedge Country Types (Country Codes)	6-5
Ignore Unknown Characters	6-7
Keystroke Delay	6-7
Intra-Keystroke Delay	6-8
Alternate Numeric Keypad Emulation	6-8
Caps Lock On	6-9
Caps Lock Override	6-9
Convert Wedge Data	6-10
Function Key Mapping	6-10

FN1 Substitution	6-11
Send Make and Break	6-11
Keyboard Maps	6-12
ASCII Character Set	6-14

Chapter 7: RS-232 Interface

Introduction	7-1
Connecting an RS-232 Interface	7-2
RS-232 Default Parameters	7-3
RS-232 Host Parameters	7-4
RS-232 Host Types	7-6
Baud Rate	7-7
Parity	7-9
Check Receive Errors	7-10
Stop Bit Select	7-11
Data Bits	7-11
Hardware Handshaking	7-12
Software Handshaking	7-14
Host Serial Response Time-out	7-16
RTS Line State	7-17
Beep on <BEL>	7-17
Intercharacter Delay	7-18
Nixdorf Mode A/B and OPOS/JPOS Beep/LED Options	7-19
Ignore Unknown Characters	7-20
ASCII / Character Set	7-20

Chapter 8: USB Interface

Introduction	8-1
Connecting a USB Interface	8-2
USB Default Parameters	8-4
USB Host Parameters	8-5
USB Device Type	8-5
USB Country Keyboard Types (Country Codes)	8-6
USB Keystroke Delay	8-8
USB Caps Lock Override	8-9
USB Ignore Unknown Characters	8-9
Emulate Keypad	8-10
USB Keyboard FN 1 Substitution	8-10
Function Key Mapping	8-11
Simulated Caps Lock	8-11
Convert Case	8-12
ASCII Character Set	8-13

Chapter 9: IBM 468X/469X Interface

Introduction	9-1
Connecting to an IBM 468X/469X Host	9-2
IBM Default Parameters	9-3
IBM 468X/469X Host Parameters	9-4
Port Address	9-4
Convert Unknown to Code 39	9-4

Chapter 10: 123Scan

Introduction	10-1
Setting Up 123Scan	10-1

Chapter 11: Symbologies

Introduction	11-1
Scanning Sequence Examples	11-1
Errors While Scanning	11-1
Symbology Default Parameters	11-2
UPC/EAN	11-5
Enable/Disable UPC-A	11-5
Enable/Disable UPC-E	11-5
Enable/Disable UPC-E1	11-6
Enable/Disable EAN-13	11-6
Enable/Disable EAN-8	11-7
Enable/Disable Bookland EAN	11-7
Decode UPC/EAN/JAN Supplementals	11-8
User-Programmable Supplementals	11-11
UPC/EAN/JAN Supplemental Redundancy	11-12
Transmit UPC-A/UPC-E/UPC-E1 Check Digit	11-12
UPC-A Preamble	11-14
UPC-E Preamble	11-15
UPC-E1 Preamble	11-16
Convert UPC-E to UPC-A	11-17
Convert UPC-E1 to UPC-A	11-17
EAN-8/JAN-8 Extend	11-18
Bookland ISBN Format	11-19
UCC Coupon Extended Code	11-20
Code 128	11-21
Enable/Disable Code 128	11-21
Enable/Disable UCC/EAN-128	11-22
Enable/Disable ISBT 128	11-22
Code 39	11-23
Enable/Disable Code 39	11-23
Enable/Disable Trioptic Code 39	11-23
Convert Code 39 to Code 32	11-24
Code 32 Prefix	11-24
Set Lengths for Code 39	11-25
Code 39 Check Digit Verification	11-26
Transmit Code 39 Check Digit	11-26

Code 39 Full ASCII Conversion	11-27
Code 93	11-28
Enable/Disable Code 93	11-28
Set Lengths for Code 93	11-28
Code 11	11-30
Code 11	11-30
Set Lengths for Code 11	11-31
Code 11 Check Digit Verification	11-32
Transmit Code 11 Check Digits	11-33
Interleaved 2 of 5 (I 2 of 5)	11-34
Enable/Disable Interleaved 2 of 5	11-34
Set Lengths for Interleaved 2 of 5	11-34
I 2 of 5 Check Digit Verification	11-36
Transmit I 2 of 5 Check Digit	11-36
Convert I 2 of 5 to EAN-13	11-37
Discrete 2 of 5 (D 2 of 5)	11-37
Enable/Disable Discrete 2 of 5	11-37
Set Lengths for Discrete 2 of 5	11-38
Codabar (NW - 7)	11-39
Enable/Disable Codabar	11-39
Set Lengths for Codabar	11-40
CLSI Editing	11-41
NOTIS Editing	11-41
MSI	11-42
Enable/Disable MSI	11-42
Set Lengths for MSI	11-43
MSI Check Digits	11-44
Transmit MSI Check Digit(s)	11-45
MSI Check Digit Algorithm	11-45
GS1 DataBar	11-46
GS1 DataBar-14	11-46
GS1 DataBar Limited	11-46
GS1 DataBar Expanded	11-47
Convert GS1 DataBar to UPC/EAN	11-47
Redundancy Level	11-48
Redundancy Level 1	11-48
Redundancy Level 2	11-48
Redundancy Level 3	11-49
Redundancy Level 4	11-49
Security Level	11-50
Security Level 0	11-50
Security Level 1	11-50
Security Level 2	11-50
Security Level 3	11-51
Bi-directional Redundancy	11-51

Chapter 12: Advanced Data Formatting

Introduction	12-1
Rules: Criteria Linked to Actions	12-1

Using ADF Bar Codes	12-2
ADF Bar Code Menu Example	12-2
Rule 1: The Code 128 Scanning Rule	12-3
Rule 2: The UPC Scanning Rule	12-3
Alternate Rule Sets	12-3
Rules Hierarchy (in Bar Codes)	12-4
Default Rules	12-5
Special Commands	12-5
Pause Duration	12-5
Begin New Rule	12-5
Save Rule	12-5
Erase	12-6
Quit Entering Rules	12-6
Disable Rule Set	12-7
Criteria	12-8
Code Types	12-8
Code Lengths	12-12
Message Containing A Specific Data String	12-16
Actions	12-21
Send Data	12-21
Setup Field(s)	12-24
Modify Data	12-30
Pad Data with Spaces	12-31
Pad Data with Zeros	12-36
Beeps	12-41
Send Keystroke (Control Characters and Keyboard Characters)	12-42
Send Right Control Key	12-78
Send Graphic User Interface (GUI) Characters	12-79
Turn On/Off Rule Sets	12-84
Alphanumeric Keyboard	12-86

Appendix A: Standard Default Parameters

Appendix B: Programming Reference

Symbol Code Identifiers	B-1
AIM Code Identifiers	B-2

Appendix C: Sample Bar Codes

UPC-A	C-1
UPC-E	C-1
UPC-E1	C-2
EAN-13	C-2
EAN-8	C-2
Code 39	C-2
Trioptic Code 39	C-3
Code 93	C-3
Code 11	C-3
Codabar	C-3
MSI	C-4
Interleaved 2 of 5	C-4

Appendix D: Numeric Bar Codes

0, 1, 2, 3	D-1
4, 5, 6, 7	D-2
8, 9	D-3
Cancel	D-3

Appendix E: Alphanumeric Bar Codes

Alphanumeric Keyboard	E-1
-----------------------------	-----

Glossary

Index

Tell Us What You Think...

About This Guide

Introduction

The *LS3578 Product Reference Guide* provides general instructions for setting up, operating, maintaining, and troubleshooting the scanner. The LS3578 includes the following variations of the scanner:

- LS3578-FZ: 1-D scanning
- LS3578-ER: extended range 1-D scanning.

Chapter Descriptions

Topics covered in this guide are as follows:

- [Chapter 1, Getting Started](#) provides a product overview and unpacking instructions.
- [Chapter 2, Scanning](#) describes parts of the scanner, beeper and LED definitions, and how to use the scanner.
- [Chapter 3, Maintenance and Technical Specifications](#) provides information on how to care for the scanner, troubleshooting, and technical specifications.
- [Chapter 4, Radio Communications](#) provides information about the modes of operation and features available for wireless communication between scanners, cradles and hosts, and also includes the parameters necessary to configure the scanner.
- [Chapter 5, User Preferences](#) describes each user preference feature and provides the programming bar codes for selecting these features for the scanner. It also includes commonly used bar codes to customize how data is transmitted to the host device.
- [Chapter 6, Keyboard Wedge Interface](#) provides information for setting up the scanner for keyboard wedge operation.
- [Chapter 7, RS-232 Interface](#) provides information for setting up the scanner for RS-232 operation.
- [Chapter 8, USB Interface](#) provides information for setting up the scanner for USB operation.
- [Chapter 9, IBM 468X/469X Interface](#) provides information for setting up the scanner with IBM 468X/469X POS systems.

- [Chapter 10, 123Scan](#) provides information on the PC-based scanner configuration tool 123Scan.
- [Chapter 11, Symbologies](#) describes all symbology features and provides the programming bar codes for selecting these features.
- [Chapter 12, Advanced Data Formatting \(ADF\)](#) describes how to customize scanned data before transmitting to the host.
- [Appendix A, Standard Default Parameters](#) provides a table of all host devices and miscellaneous scanner defaults.
- [Appendix B, Programming Reference](#) provides a table of AIM code identifiers, ASCII character conversions, and keyboard maps.
- [Appendix C, Sample Bar Codes](#) includes sample bar codes.
- [Appendix D, Numeric Bar Codes](#) includes the numeric bar codes to scan for parameters requiring specific numeric values.
- [Appendix E, Alphanumeric Bar Codes](#) includes the alphanumeric bar codes to scan for parameters requiring alphanumeric values.

Notational Conventions

The following conventions are used in this document:

- *Italics* are used to highlight the following:
 - Chapters and sections in this and related documents
- **Bold** text is used to highlight the following:
 - Key names on a keypad
 - Button names on a screen or window.
- bullets (•) indicate:
 - Action items
 - Lists of alternatives
 - Lists of required steps that are not necessarily sequential
- Sequential lists (e.g., those that describe step-by-step procedures) appear as numbered lists.
- Throughout the programming bar code menus, asterisks (*) are used to denote default parameter settings.

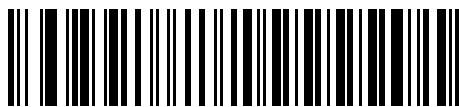

* Indicates Default — * **Baud Rate 9600** — Feature/Option



NOTE This symbol indicates something of special interest or importance to the reader. Failure to read the note will not result in physical harm to the reader, equipment or data.



CAUTION This symbol indicates that if this information is ignored, the possibility of data or material damage may occur.



WARNING! This symbol indicates that if this information is ignored the possibility that serious personal injury may occur.

Related Documents

- *LS3578 Quick Start Guide* (p/n 72-93587-xx) provides general information to help the user get started with the scanner, including basic setup and operation instructions.
- *Symbol STB3508/3578 Cradle Quick Reference Guide* (p/n 72-93912-xx) provides information on installing and operating STB3508/3578 cradles.
- *Symbol FLB3508/3578 Cradle Quick Reference Guide* (p/n 72-94604-xx) provides information on installing and operating FLB3508/3578 cradles.

For the latest version of this guide and all guides, go to: <http://www.motorolasolutions.com/support>

Service Information

If you have a problem using the equipment, contact your facility's technical or systems support. If there is a problem with the equipment, they will contact the Motorola Solutions Global Customer Support Center at: <http://www.motorolasolutions.com/support>.

When contacting Motorola Solutions support, please have the following information available:

- Serial number of the unit
- Model number or product name
- Software type and version number

Motorola responds to calls by e-mail, telephone or fax within the time limits set forth in service agreements. If your problem cannot be solved by Motorola Solutions support, you may need to return your equipment for servicing and will be given specific directions. Motorola is not responsible for any damages incurred during shipment if the approved shipping container is not used. Shipping the units improperly can possibly void the warranty.

If you purchased your business product from a Motorola business partner, please contact that business partner for support.

Chapter 1 Getting Started

Introduction

The LS3578 scanner combines excellent scanning performance and advanced ergonomics to provide the best value in a lightweight laser scanner, ensuring comfort and ease of use for extended periods of time.

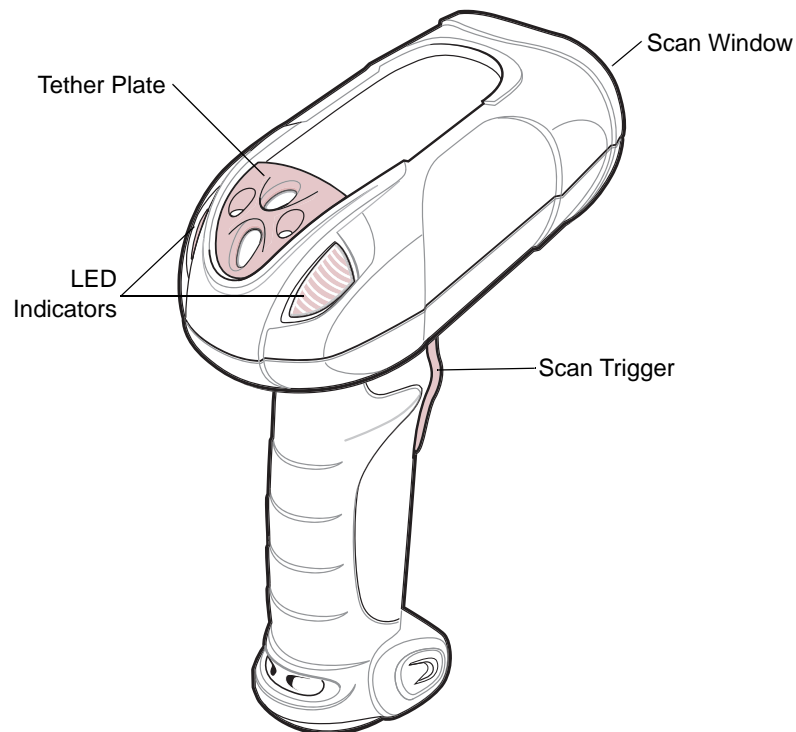

Figure 1-1 *LS3578 Scanner*

This scanner supports the following host interfaces through communication with a cradle:

- Standard RS-232 connection to a host.
- Keyboard wedge connection to a host, where scanned data is interpreted as keystrokes. The following international keyboards are supported (for Windows™ environment): North American, German, French, French Canadian, Spanish, Italian, Swedish, UK English, Japanese, and Brazilian-Portuguese.
- IBM® 468X/469X hosts.
- USB connection to a host. The scanner autodetects a USB host and defaults to the HID keyboard interface type. Select other USB interface types by scanning programming bar codes. The following international keyboards are supported (for Windows™ environment): North America, German, French, French Canadian, Spanish, Italian, Swedish, UK English, Japanese, and Brazilian-Portuguese.
- Synapse capability, which allows connection to a wide variety of host systems using a Synapse cable and Synapse adapter cable. The scanner autodetects the Synapse interface.
- Configuration via 123Scan.

Unpacking the Scanner

Remove the scanner from its packing and inspect it for damage. If the scanner was damaged in transit, contact the Motorola Solutions Global Customer Support Center. See [page xv](#) for contact information. **KEEP THE PACKING.** It is the approved shipping container and should be used if the equipment ever needs to be returned for servicing.

The Cradle

The cradles serve as a stand and charger for the LS3578 cordless scanner. Some models also provide a host communication interface. There are four versions of the cradle:

- The **STB3508 cordless cradle** sits on a desktop or mounts on a wall, and charges the LS3578 cordless scanner. An external power supply or a powered host cable charges the scanner.
- The **STB3578 cordless cradle** sits on a desktop or mounts on a wall, and charges the LS3578 cordless scanner. This cradle also provides host communication by receiving scanner data via a Bluetooth radio, and sending that data to the host through an attached cable. An external power supply or a powered host cable charges the scanner.
- The **FLB3508 cordless cradle** charges the LS3578 cordless scanner. The cradle attaches to a mounting bracket using three isolators, and the bracket then mounts on the forklift surface. A portable power supply on the forklift provides power to the cradle.
- The **FLB3578 cordless cradle** charges the LS3578 cordless scanner, and provides host communication by receiving scanner data via a Bluetooth radio, and sending that data to the host through an attached cable. The cradle attaches to a mounting bracket using three isolators, and the bracket then mounts on the forklift surface. A portable power supply on the forklift provides power to the cradle.

DO NOT use these cradles with a Symbol LS3478 scanner. Likewise, **DO NOT** use cradles designed for the LS3478 to charge or provide communication for a LS3578 scanner.

✓ **NOTE** For more information about communication between the scanner, cradle, and host, see [Chapter 4, Radio Communications](#).

For more information about mounting options and procedures, refer to the documentation included with the cradle.

Cradle Parts

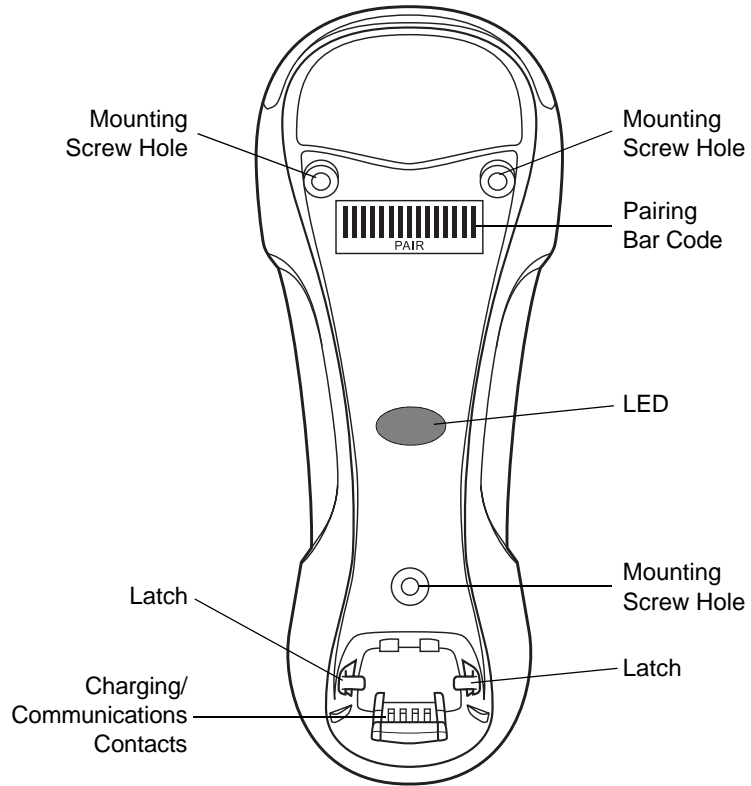

Figure 1-2 Cradle Front View

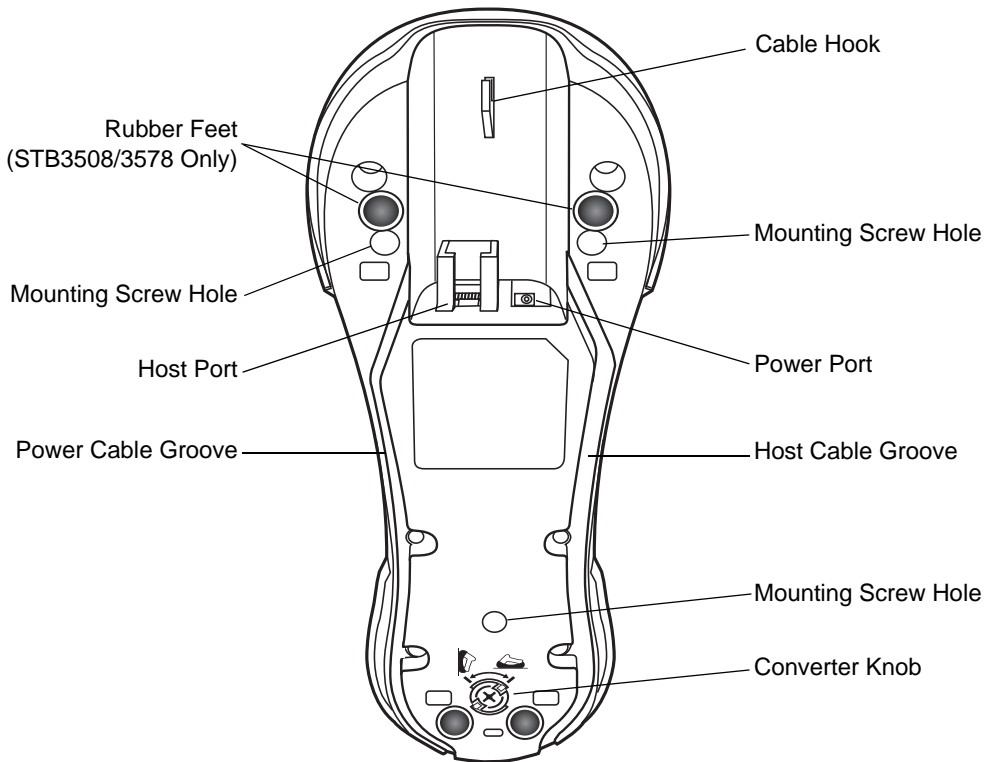

Figure 1-3 Cradle Back View

Connecting the Cradle

Important: Connect the interface cable and power supply (if necessary) in the following order to ensure proper operation of the scanner and cradle.

Connecting STB3508/3578 Cradle

1. Insert the interface cable into the cradle's host port. See [Figure 1-4](#).
2. Connect the other end of the interface cable to the host.
3. If necessary, connect the power supply to the cradle's power port (if the interface requires, or to allow fast charging of the scanner).
4. Connect the appropriate cable to the power supply and an AC power source, if necessary.
5. If applicable, thread the interface cable over the cable support hook and run the host and power cables into their respective cable grooves.
6. Pair the scanner to the cradle by scanning the pairing bar code on the cradle.
7. If necessary, scan the appropriate host bar code (for non-autodetected interfaces). See the specific host chapter.

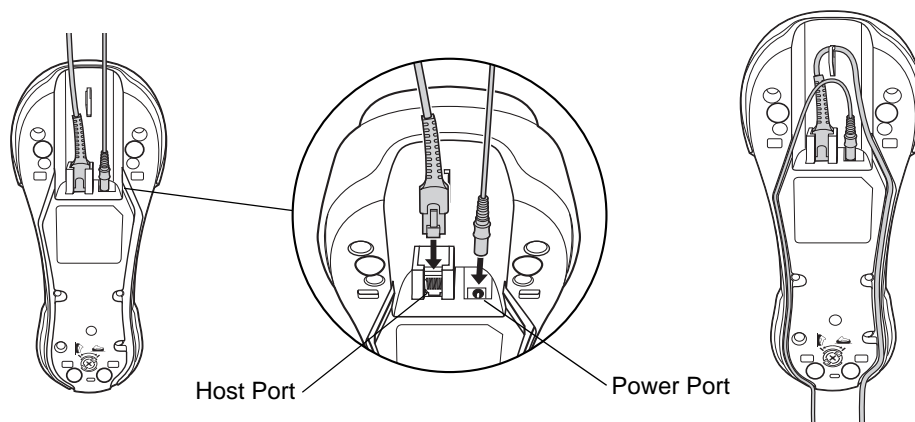

Figure 1-4 Connecting the Cables to the Cradle



NOTE Disconnect the power supply before changing host cables, or the scanner may not recognize the new host.

Different cables are required for different hosts. The connectors illustrated in each host chapter are examples only. The connectors may be different from those illustrated, but the steps to connect the scanner remain the same.

Connecting FLB3508/3578 Cradle

1. Insert the interface cable from the host computer into the cradle's host port. See [Figure 1-4](#).
2. Connect the forklift power supply to the cradle's power port, if applicable.
3. Optionally, thread the host cable over the cable hook and run the host and power cables into their respective cable grooves, or use cable ties to secure them to the mounting plate after attaching it to the cradle. For more information about mounting options and procedures, refer to the documentation included with the cradle.
4. Pair the scanner with the cradle by scanning the pairing bar code on the cradle.
5. If necessary, scan the appropriate host bar code (for non-autodetected interfaces). See the specific host chapter.

Changing the Host Interface

To connect to a different host, or to the same host using a different cable:

1. Disconnect the power supply from the cradle, if used.
2. Disconnect the interface cable from the host.
3. Connect the interface cable to the new host, or the new interface cable to the existing host.
4. Reconnect the power supply, if required.
5. If necessary, scan the appropriate host bar code (for non-autodetected interfaces). See the specific host chapter.



CAUTION If the scanner does not recognize the host, disconnect the power supply, then reconnect after connecting the host cable.

Supplying Power to the Cradle

The cradle receives power from one of two sources:

- An external power supply.
- When connected to the host through an interface cable that supplies power.

The cradle detects whether the host or the external supply is supplying power. It always draws power from the external supply when available, regardless of the presence of power from a host.

Using the USB Interface to Supply Power

When the cradle is connected to the host via the USB interface, the USB port can power the cradle so that an external power supply is not necessary. Note that powering from a USB host charges the scanner at a slower rate than when charging from an external power supply.

Connecting a Synapse Cable Interface



NOTE Refer to the *Synapse Interface Guide* provided with the Synapse cable for more information.

Symbol's Synapse Smart Cables enable interfacing to a variety of hosts. The appropriate Synapse cable detects the host.

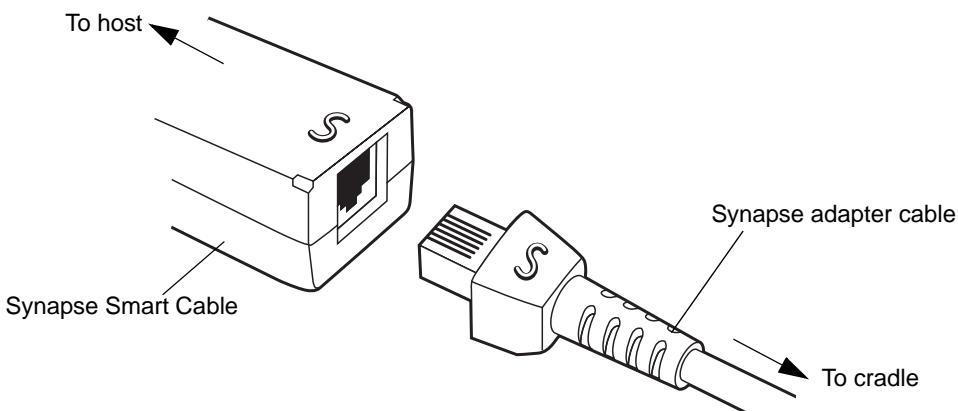

Figure 1-5 Synapse Cable Connection

1. Insert the Synapse adapter cable into the bottom of the cradle, as described in *Connecting the Cables to the Cradle* on page 1-5.
2. Align the 'S' on the Synapse adapter cable with the 'S' on the Synapse Smart Cable and plug the cable in.
3. Connect the other end of the Synapse Smart Cable to the host.

Mounting the Cradle

For information on mounting the cradle, refer to the documentation included with the cradle.

Inserting the Battery

The battery resides in a chamber in the scanner handle. To insert the battery:

1. Insert a coin or flathead screwdriver in the slot at the base of the scanner, then turn the slot counterclockwise to release the latch.
2. Lift the latch.
3. If a battery is already installed, turn the scanner upright to slide the battery out.
4. Slide the new battery into the chamber, with the rounded side toward the back and the contacts facing into the chamber.

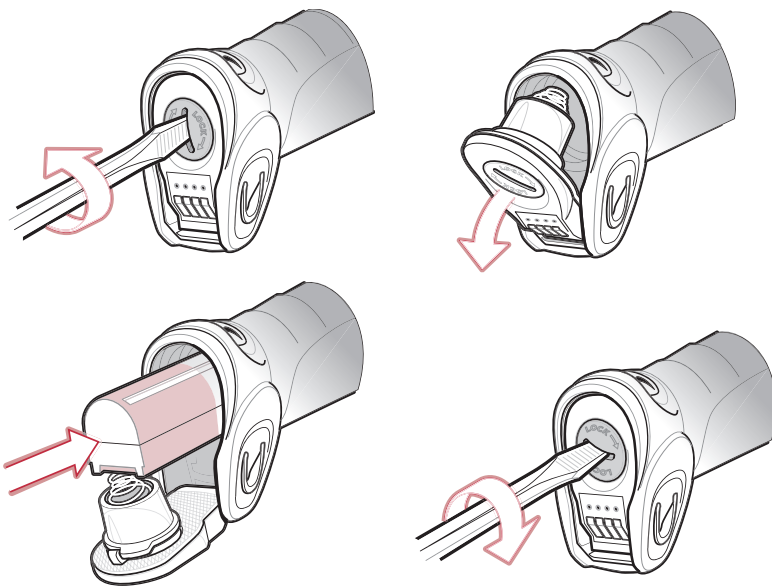

Figure 1-6 *Inserting the Battery*

5. Close the latch.
6. Insert a coin or flathead screwdriver in the slot at the base of the scanner, press down gently, and turn the slot clockwise to lock the latch in place.

Removing the Battery

To remove the battery:

1. Insert a coin or flathead screwdriver in the slot at the base of the scanner, then turn the slot counterclockwise to release the latch.
2. Lift the latch.
3. Turn the scanner upright to slide the battery out.

Charging the Scanner Battery in the Cradle

For best performance, fully charge the scanner battery before using the scanner for the first time. To charge the scanner battery, place the scanner in the cradle (see *Inserting the Scanner in the Cradle on page 1-9*). The battery begins charging when the scanner LED indicator starts flashing green. A complete charge of a fully discharged battery can take up to four hours using external power and up to 10 hours using the interface cable.

Charge within the recommended temperature of 32° to 104° F (0° to 40° C) nominal, 41° to 95° F (5° to 35° C) ideal.

For information on maximizing battery life, see *Battery Maintenance on page 3-1*.

Scanner Charging LED

The scanner's green LED indicates charging activity (see [Table 2-2 on page 2-4](#)). If the scanner is charging in fast mode (non-bus powered mode), the green LED blinks at a fast rate. If the scanner is charging in slow mode (bus-powered mode), the LED blinks at a slow rate.

If the scanner's red LED begins flashing, indicating a charging problem, remove the scanner from the cradle and replace the battery. If the red LED continues flashing, contact the Motorola Solutions Global Customer Support Center.

Inserting the Scanner in the Cradle

To insert the scanner in the cradle:

1. Insert the scanner into the cradle top first.
2. Push the handle until it clicks into place, engaging the contacts in the cradle and scanner.

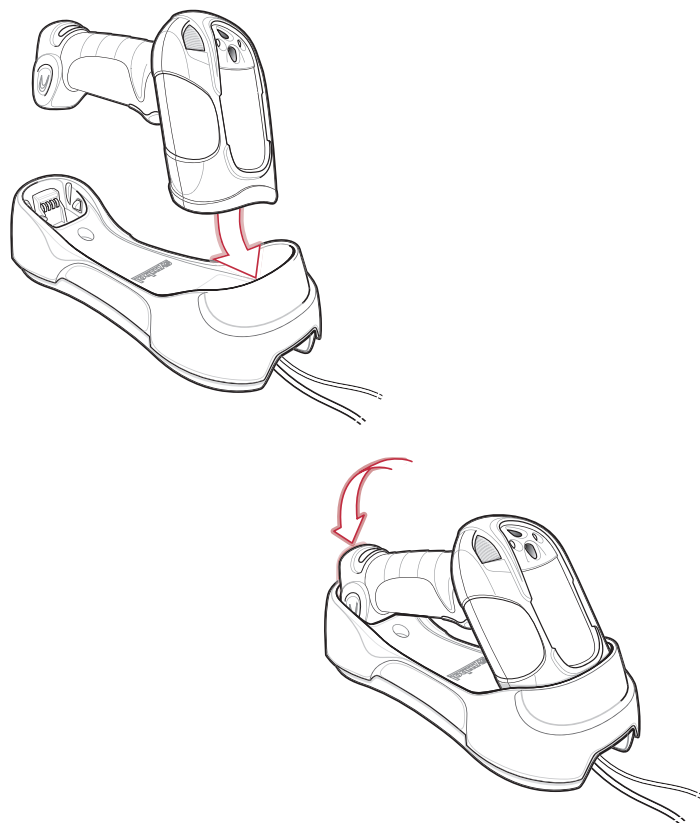

Figure 1-7 *Inserting the Scanner in the Cradle*

Sending Data to the Host Computer

The cradle receives data from the scanner via a wireless radio connection and transmits it to the host computer via the host cable. The scanner and cradle must be paired for successful wireless communication.

Pairing

Pairing registers a scanner to the cradle such that the scanner and cradle can exchange information. The STB3578 and FLB3578 operate in two modes: Point-to-Point and Multipoint-to-Point. In Point-to-Point mode, pair the scanner to the cradle either by inserting it in the cradle (if pairing on insertion is enabled), or by scanning the pairing bar code. In Multipoint-to-Point mode, you can pair up to three scanners to one cradle. To use this feature, scan the multipoint bar code in *Multipoint-to-Point Communication on page 4-20*.

The cradle includes pairing bar codes on both its front and back. To pair the scanner with the cradle, scan a pairing bar code. A high-low-high-low beep sequence followed by a low-high beep sequence indicates successful pairing and connection to the remote device. A long low, long high beep sequence indicates unsuccessful pairing.



NOTE The pairing bar code that connects the scanner to a cradle is unique to each cradle.

Do not scan data or parameters until pairing completes.

Lost Connection to Host

If scanned data does not transmit to the cradle's host, ensure that all cables are firmly inserted and the power supply is connected to an appropriate AC outlet, if applicable. If scanned data still does not transmit to the host, reestablish a connection with the host:

1. Disconnect the power supply from the cradle.
2. Disconnect the host interface cable from the cradle.
3. Wait three seconds.
4. Reconnect the host interface cable to the cradle.
5. Reconnect the power supply to the cradle, if the host requires.
6. Reestablish pairing with the cradle by scanning the pairing bar code.

Configuring the Scanner

Use the bar codes in this manual or the 123Scan configuration program to configure the scanner. See [Chapter 5, User Preferences](#) and each host chapter for information about programming the scanner using bar code menus. See [Chapter 10, 123Scan](#) to configure the scanner using this configuration program. 123Scan includes a help file.

Radio Communications

The scanner can communicate with remote devices via Bluetooth Technology Profile Support, or by pairing with a cradle. For radio communication parameters, detailed information about operational modes, Bluetooth Technology Profile Support and pairing, see [Chapter 4, Radio Communications](#).

Chapter 2 Scanning

Introduction

This chapter provides beeper and LED definitions, scanning techniques, general scanning instructions and tips, and decode zone diagrams.

Beeper Definitions

The scanner emits different beeper sequences and patterns to indicate its status. [Table 2-1](#) defines beep sequences that occur during both normal scanning and while programming the scanner.

Table 2-1 *Standard Beeper Definitions*

Beeper Sequence	Indication
Standard Use	
Short low-short medium-short high beeps	Power up.
One short high beep	A bar code symbol was decoded (if decode beeper is enabled).
Four long low beeps	A communication error occurred while transmitting a scanned symbol to a host. The data is ignored. This occurs if the scanner is not properly configured or if the scanner has disconnected from the cradle.
Low beep	The scanner detects power when inserted into a cradle. Note: This feature can be disabled.
Low-high-low-high beeps	Out of memory - the scanner cannot store the new bar code data. The scanner was inserted in an incompatible/older cradle.
Four short high beeps	Low battery indication.
Five long low beeps	Conversion or format error.
Wireless Operation	
Short low-high beeps	Scanner has paired with the cradle.

Table 2-1 Standard Beeper Definitions (Continued)

Beeper Sequence	Indication
Short high-low beeps	Scanner has unpaired with the cradle. Note: When connected to a remote device using SPP or HID, if a disconnect beep sequence sounds immediately after scanning a bar code, check the host device to determine if it received the transmitted data. The scanner may have transmitted the last bar code scanned after losing the connection.
Long low-long high beeps	Unsuccessful pairing attempt. See <i>Auto-reconnect Feature on page 4-15</i> .
Long low-long high-long low-long high beeps	Remote device rejected connection attempt, possibly due to an attempt to pair with a cradle that is already paired with the maximum number of scanners.
Four long low beeps	<ol style="list-style-type: none"> 1. A transmission error was detected in a scanned symbol. The data is ignored. This occurs if a unit is not properly configured. Check option setting. 2. When communicating with a cradle, the cradle acknowledges receipt of data. If the acknowledgment is not received, this transmission error beep sequence sounds. Data may still have been received by the host. Check the host system for receipt of transmitted data. If data was not received by the host, re-scan the bar code.
Five high beeps	Emitted every 5 seconds while a reconnection attempt is in progress. See <i>Auto-reconnect Feature on page 4-15</i> .
Parameter Menu Scanning	
Short high beep	Correct entry scanned or correct menu sequence performed.
Long low-long high beeps	Input error; incorrect bar code, programming sequence, or Cancel scanned. Scanner remains in program mode.
Short high-short low beeps	Keyboard parameter selected. Enter value using numeric bar codes.
Short high-short low-short high-short low beeps	Successful program exit with change in the parameter setting.
Long low-long high-long low-long high beeps	Out of host parameter storage space. See <i>Default Parameters on page 5-4</i> .
ADF Programming Normal Data Entry	
High-low beeps	Enter another digit. Add leading zeros to the front if necessary.
Low-low beeps	Enter another alphabetic character or scan the End of Message bar code.
High-high beeps	Enter another criterion or action, or scan the Save Rule bar code.
High-low-high-low beeps	Rule saved. Rule entry mode exited.
High-low-low beeps	All criteria or actions cleared for current rule, continue entering rule.

Table 2-1 Standard Beeper Definitions (Continued)

Beeper Sequence	Indication
Low beep	Delete last saved rule. The current rule is left intact.
Low-high-high beeps	All rules have been deleted.
Short low-short high-short low-short high beeps	Out of host ADF parameter storage space. See <i>Default Parameters</i> on page 5-4.
ADF Programming Error Indications	
Low-high-low-high beeps	Out of rule memory. Erase some existing rules, then try to save rule again. (It is not necessary to re-enter the current rule.) An LS3578 scanner was inserted into an STB3478 cradle.
Low-high-low beeps	ADF transmit error. Cancel rule entry. Rule entry mode exited because of an error or the user asked to exit rule entry.
Low-high beeps	Entry error, wrong bar code scanned. Re-enter criterion or action. All previously entered criteria and actions are retained. Criteria or action list is too long for a rule.
Host Specific	
USB Only	
Four high beeps	The scanner did not complete initialization. Wait several seconds and scan again.
Short low-short medium-short high beeps (power-up sequence)	The scanner scanned a USB device type. The scanner must establish communication with the bus before it can operate at the highest power level.
Short low-short medium-short high beeps (power-up sequence) occur more than once	The USB bus may cause power to the scanner to cycle on and off more than once. This is normal and usually happens when the host PC cold boots.
RS-232 only	
High-high-high-low beeps	RS-232 receive error.
High beep	A <BEL> character is received and Beep on <BEL> is enabled (Point-to-Point mode only).

LED Definitions

In addition to beeper sequences, the scanner uses a two-color LED to indicate its status, and the cradle's LED indicates charge and communication status. [Table 2-2](#) explains scanner LED sequences, and [Table 2-3](#) explains cradle LED sequences.

Table 2-2 *Scanner LED Status Indications*

LED	Indication
Standard Use	
Off	No power is applied to the scanner (battery is discharged or removed); scanner is in low power and ready to scan.
Green	A bar code was successfully decoded.
Red	A data transmission error, scanner malfunction, or the LS3578 scanner was inserted into an STB3478 cradle.
Charging Use	
Green Slow Flash	The scanner charges at the slow rate (used when a host cable powers the cradle).
Green Fast Flash	The scanner charges at the fast rate (used when an external power supply powers the cradle).
Red flash	Charging problem. Contact the Motorola Solutions Global Customer Support Center. The LS3578 scanner was inserted into an STB3478 cradle.
Red and green flash	Temperature fault. Move the cradle to a location where the temperature is 0° - 40° C; optimal charging temperature is 5° - 35° C.

Table 2-3 *Cradle LED Status Indications*

LED	Indication
Flashing Green	The cradle is externally powered with a USB host interface that has suspended the cradle. The cradle is no longer connected to the scanner but the can charge the scanner. Scan the pairing bar code to re-pair the scanner.
Flashing Red	Transmission error, or you inserted an LS3478 scanner into the STB3578 cradle.

Scanning

See [Chapter 1, Getting Started](#) to install and program the scanner. To scan:

1. Aim the scanner at the bar code.
2. Press the scan trigger.

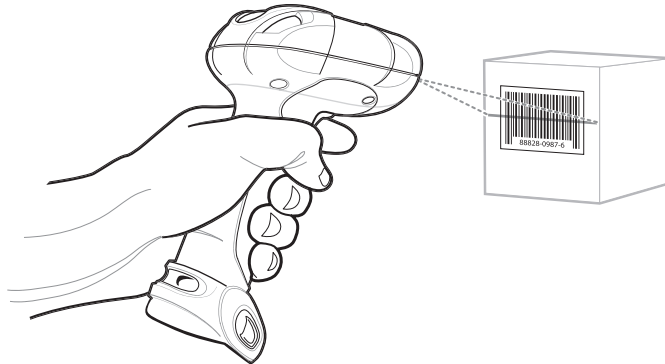
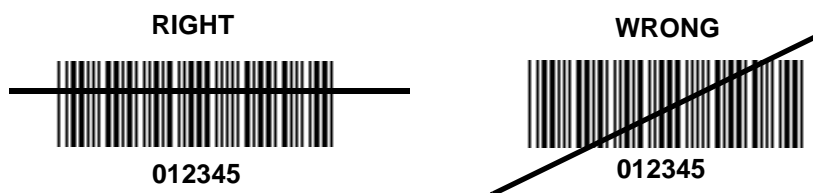

Figure 2-1 *Aiming the Scanner*

3. Ensure the scan line crosses every bar and space of the symbol.



4. The scanner beeps and the LED turns green to indicate a successful decode. See [Table 2-1](#) and [Table 2-2](#) for beeper and LED definitions.

Aiming

Do not hold the scanner directly over the bar code. Laser light reflecting directly back into the scanner from the bar code is known as specular reflection which can make decoding difficult.

Tilt the scanner up to 65° forward or back to achieve a successful decode. Simple practice shows what tolerances to work within.

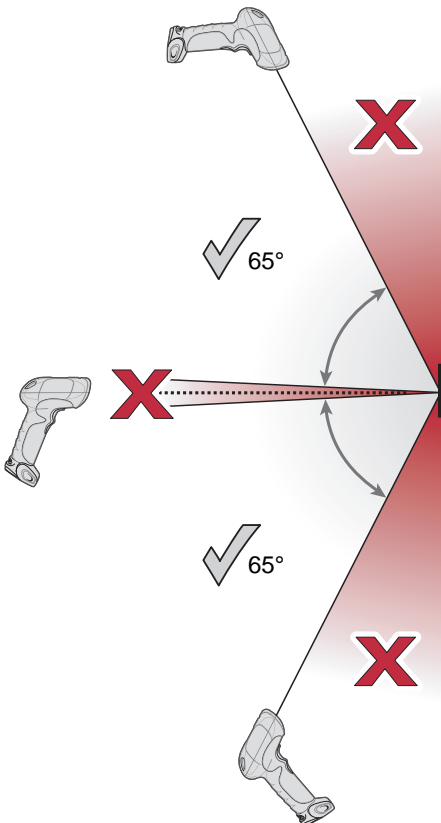
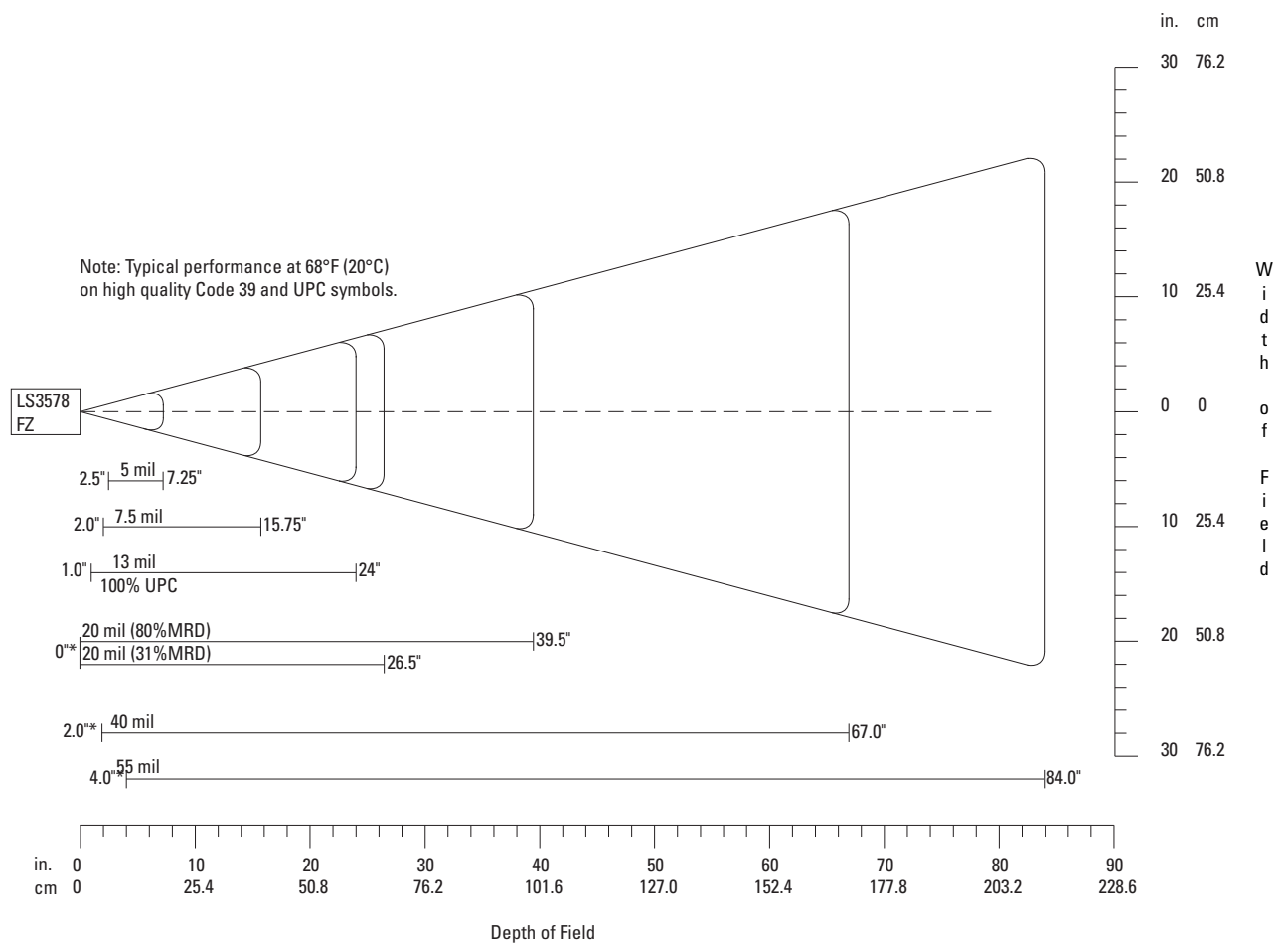

Figure 2-2 *Optimum Scan Angles*

Decode Zone



*Minimum distance determined by symbol length and scan angle

Figure 2-3 LS3578-FZ Decode Zone

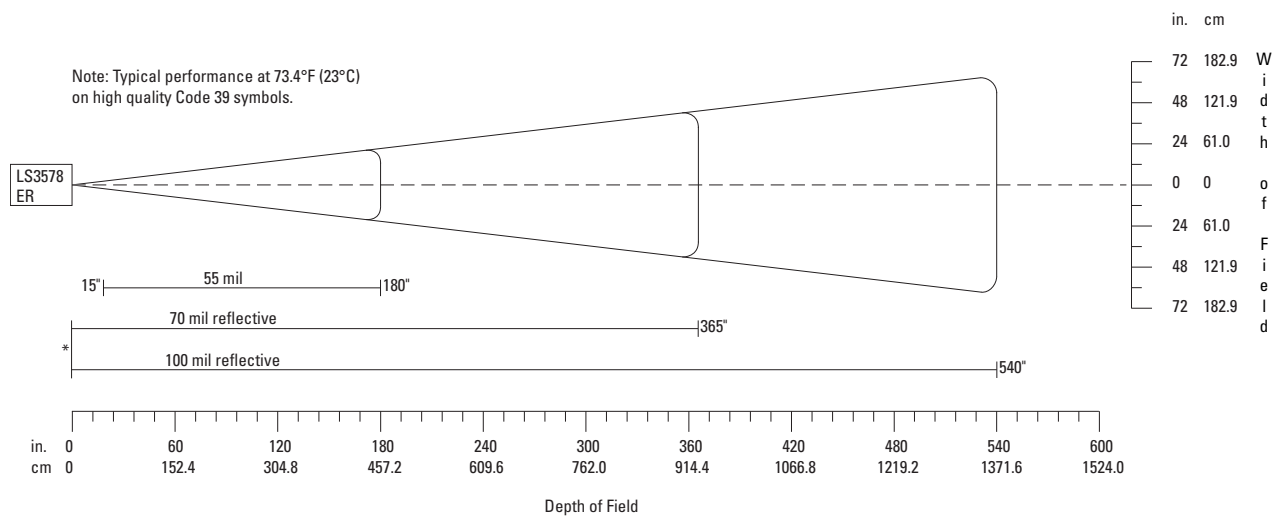
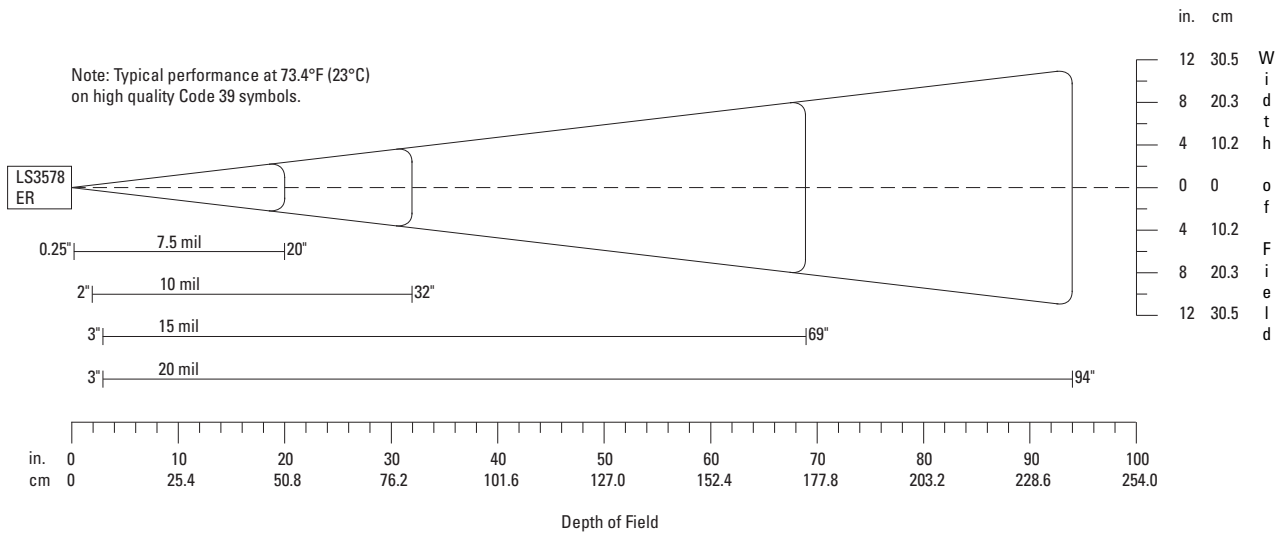

*Near range determined by degree of reflectivity and width of bar code.

Figure 2-4 LS3578-ER Decode Zone

Chapter 3 Maintenance and Technical Specifications

Introduction

This chapter provides suggested scanner maintenance, troubleshooting, technical specifications, and signal descriptions (pinouts).

Maintenance

Cleaning the scan window is the only maintenance required. A dirty window can affect scanning accuracy.

- Do not allow any abrasive material to touch the window.
- Remove any dirt particles with a damp cloth.
- Wipe the window using a tissue moistened with ammonia/water.
- Do not spray water or other cleaning liquids directly onto the window.

Battery Maintenance

When batteries are stored over a year, battery cell manufacturers advise that some irreversible deterioration in overall battery quality may occur. To minimize this loss, they recommend storing batteries half charged in a dry, cool place between 41° and 77°F (5° and 25°C), the cooler the better, and removed from the equipment to prevent the loss of capacity. Batteries should be charged to half capacity at least once a year. In order to charge a battery to half capacity, take a fully discharged battery and charge it for 2 hours. If an electrolyte leakage is observed, avoid any contact with the affected area and properly dispose of the battery.

Troubleshooting

Table 3-1 *Troubleshooting*

Problem	Possible Causes	Possible Solutions
Scanner emits short low-short medium-short high beep sequence.	Scanner is powering up.	Normal when scanner battery is inserted.
Nothing happens when scan trigger is pressed.	No power to the scanner.	Check battery. Ensure that end cap to battery chamber is secured.
	Scanner is disabled.	For Simple Serial Interface (SSI), Synapse, or IBM-468x mode, enable the scanner via the host interface. Otherwise, call the Motorola Solutions Global Customer Support Center (see page xv) for contact information).
	If using RS-232 Nixdorf B mode, CTS is not asserted.	Assert CTS line.
Laser comes on, but scanner does not decode the bar code.	Scanner is not programmed for the correct bar code type.	Ensure the scanner is programmed to read the type of bar code being scanned.
	Bar code symbol is unreadable.	Check the symbol to ensure it is not defaced. Try scanning test bar codes of the same bar code type. See Appendix C, Sample Bar Codes for test bar codes.
	Bar code is out of range of the scanner.	Move scanner closer to or further from bar code.
Scanner emits four short high beeps.	Battery is low.	Charge the battery. See <i>Charging the Scanner Battery in the Cradle on page 1-8</i> .
Scanner emits a disconnect (short high-short low) beep sequence.	Scanner has disconnected from cradle because it is too far from the cradle.	Move closer to the cradle and listen for a reconnection beep (short low-short high).
	Scanner has disconnected from the cradle because the cradle has lost power or been placed in USB suspend mode.	Check power connections to cradle, and if using a USB cable, check to make sure PC has not entered a power save mode.

Table 3-1 Troubleshooting (Continued)

Problem	Possible Causes	Possible Solutions
Scanner emits four long low beeps after scanning a bar code.	Incorrect host interface cable is used.	Ensure that correct host interface cable is used.
	Interface/power cables to cradle are loose.	Ensure all cable connections are secure.
	Scanner is not paired to a cradle.	Scan the PAIR bar code on the cradle that is connected to the host that is to receive data.
	Scanner has disconnected.	See disconnect beep sequence above.
	A transmission error was detected.	Ensure the cradle's communication parameters match the host's setting.
	Cradle has not completed USB initialization.	Wait several seconds and scan again.
Bar code is decoded, but data is not transmitted to the host.	Scanner not paired to host-connected cradle.	Pair the scanner to the cradle (using PAIR bar code on the cradle).
	Cradle not programmed for correct host interface.	Check scanner host parameters or edit options.
	Interface cable is loose.	Ensure all cable connections are secure.
	Cradle has lost connection to host.	<i>In this exact order:</i> disconnect power supply; disconnect host cable; wait three seconds; reconnect host cable; reconnect power supply; reestablish pairing.
Five long low beeps sound after a bar code is decoded	A conversion error or format error has been detected.	Ensure the scanner's conversion parameters are properly configured.
Scanned data is incorrectly displayed on the host.	Cradle host communication parameters do not match host's parameters.	Ensure proper host is selected.
		For RS-232, ensure the cradle's communication parameters match the host's settings.
		For a Keyboard Wedge configuration, ensure the system is programmed for the correct keyboard type, and the CAPS LOCK key is off.
Ensure editing options (e.g., UPC-E to UPC-A conversion) are properly programmed.		
Scanner emits short high-short high-short high-long low beep sequence when it is not in use.	RS-232 receive error.	Normal during host reset. Otherwise, ensure the scanner's RS-232 parity setting matches the host setting.
Scanner emits long low-long high beep sequence during programming.	Input error or Cancel bar code was scanned.	Ensure the correct numeric bar codes, that are within range for the parameter being programmed, are being scanned.

Table 3-1 *Troubleshooting (Continued)*

Problem	Possible Causes	Possible Solutions
Scanner emits short low-short high- short low-short high beep sequence while it is being programmed.	Out of ADF parameter storage space.	Erase all rules and re-program with shorter rules.
	Out of Synapse parameter storage space.	Scan Set Synapse Defaults code, from the appropriate <i>Synapse Interface Guide</i> , for cables no longer in use and re-program the scanner for the current host interface.
Scanner emits one short high beep when it is not in use.	In RS-232 mode, a <BEL> character is received and Beep on <BEL> option is enabled.	Normal when Beep on <BEL> is enabled and the scanner is in RS-232 mode.
Cradle does not work after following installation procedures.	Cradle is not receiving power.	Check system power.
	Cable connections are not secure.	Reinsert cables properly.
	The scanner is not inserted properly in the cradle.	Reinsert scanner.
	Cradle is not properly connected to the host.	Check that host settings are correct, and connect the cradle to the appropriate port on the host.
Battery does not charge.	Cradle is outside the charging temperature range.	Charge within the recommended temperature of 32° to 104° F (0° to 40° C) nominal, 41° to 95° F (5° to 35° C) ideal.



NOTE If problems still occur, contact the distributor or the Motorola Solutions Global Customer Support Center. See [page xv](#) for contact information.

Technical Specifications

Table 3-2 *Technical Specifications - Scanner*

Item	Description	
	LS3578-FZ	LS3578-ER
Battery	Rechargeable Lithium-Ion 2200 mAh (3.7V)	
Decode Capability	UPC/EAN, Bookland EAN, UPC/EAN with supplementals, Code 128, UCC/EAN 128, ISBT 128, Code 39, Trioptic Code 39, Code 93, Code 11, Interleaved 2 of 5, Discrete 2 of 5, Codabar (NW-7), MSI, GS1 DataBar.	
Beeper Operation	User-selectable: Enable, Disable	
Beeper Volume	User-selectable: Three levels	
Beeper Tone	User-selectable: Three tones	
Scan Repetition Rate	36 scans/second	
Yaw Tolerance	± 50° from nominal	± 60° from nominal
Pitch Tolerance	± 65° from nominal	± 65° from nominal
Roll Tolerance	± 20° from nominal	± 10° from nominal
Print Contrast Minimum	25% minimum reflectance differential, measured at 650 nm.	
Ambient Light Tolerance	Tolerant to typical artificial indoor and natural outdoor (direct sunlight) lighting conditions. Fluorescent, Incandescent, Mercury Vapor, Sodium Vapor, LED: 450 Ft Candles (4,844 Lux) Sunlight: 8000 Ft Candles (86,111 Lux) Note: LED lighting with high AC ripple content can impact scanning performance.	
Durability	6.5 ft (2.0 m) drops to concrete; 5 ft (1.5 m) at -4° F (-20° C)	
Operating Temperature	-4° to 122° F (-20° to 50° C)	
Storage Temperature	-40° to 158° F (-40° to 70° C)	
Charging Temperature	32° to 104° F (0° to 40° C) nominal, 41° to 95° F (5° to 35° C) ideal	
Humidity	5% to 95% (non-condensing)	
ESD	15 kV air discharge 8 kV contact discharge	
Weight	14.6 oz (414 grams)	14.8 oz (420 grams)
Dimensions:		
Height	7.34 in. (18.65 cm)	
Width	4.82 in. (12.25 cm)	
Depth	2.93 in. (7.43 cm)	
Laser	650nm laser diode	
Laser Classifications	IEC 825-1 Class 2	

Table 3-2 *Technical Specifications - Scanner (Continued)*

Item	Description	
	LS3578-FZ	LS3578-ER
Minimum Element Width	5 mil (0.127 mm)	7.5 mil (0.191 mm)
Interfaces Supported	Keyboard Wedge, RS-232, USB, IBM 468X/469X, Synapse, 123Scan	
Radio	Bluetooth, Class 2, Version 1.2, Serial Port & HID Profiles 2.402 to 2.480 GHz Adaptive Frequency Hopping (co-existence with 802.11 wireless networks) Data rate: 720 kbps	
Electrical Safety	Certified Pending to UL1950, CSA C22.2 No.950. EN60950/IC950	
Input Transient Protection	IEC 1000-4-(2,3,4,5,6,11)	
EMI	FCC Part 15 Class B, ICES-003 Class B European Union EMC Directive, Australian SMA, Taiwan EMC, Japan VCCI/MITI/Dentori	

Table 3-3 *Technical Specifications - Cradles*

Item	Description	
	STB3508 and FLB3508	STB3578 and FLB3578
Power Requirements	4.75 - 14.0 VDC	
Typical Current Draw		
Not Charging:	35 mA @ 5V 45 mA @ 9V	80 mA @ 5V 85 mA @ 9V
Fast Rate Charge:	850 mA @ 5V 610 mA @ 9V	920 mA @ 5V 655 mA @ 9V
Slow Rate Charge:	400 mA @ 5V 275 mA @ 9V	440 mA @ 5V 310 mA @ 9V
Interfaces Supported	None	Keyboard Wedge, RS-232, USB, IBM 468X/469X, Synapse
Operating Temperature	-4° to 122° F (-20° to 50° C)	
Storage Temperature	-40° to 158° F (-40° to 70° C)	
Charging Temperature	32° to 104° F (0° to 40° C) nominal, 41° to 95° F (5° to 35° C) ideal	
Humidity	5% to 95% (non-condensing)	
ESD	15 kV air discharge 8 kV contact discharge	
Weight	10.5 oz (298 grams)	

Table 3-3 Technical Specifications - Cradles (Continued)

Item	Description	
	STB3508 and FLB3508	STB3578 and FLB3578
Dimensions: Height Width Depth	9.5 in. (24.1 cm) 4.0 in (10.2 cm) 2.9 in (7.4 cm)	
Radio	N/A	Bluetooth, Class 2, Version 1.2, Serial Port & HID Profiles 2.402 to 2.480 GHz Adaptive Frequency Hopping (co-existence with 802.11 wireless networks) Data rate: 720 kbps
Electrical Safety	Certified Pending to UL1950, CSA C22.2 No.950. EN60950/IC950	
Input Transient Protection	IEC 1000-4-(2,3,4,5,6,11)	
EMI	FCC Part 15 Class B, ICES-003 Class B European Union EMC Directive, Australian SMA, Taiwan EMC, Japan VCCI/MITI/Dentori	

Scanner Signal Descriptions

The signal descriptions in [Table 3-4](#) apply to the 10-pin RJ connector on the cradle and are for reference only.

Table 3-4 Cradle to Host Pin-outs

Pin	IBM	Synapse	RS-232	Keyboard Wedge	USB
1	Reserved	SynClock	Reserved	Reserved	Jump to Pin 6
2	Power	Power	Power	Power	Power
3	Ground	Ground	Ground	Ground	Ground
4	IBM_A(+)	Reserved	TxD	KeyClock	Reserved
5	Reserved	Reserved	RxD	TermData	D +
6	IBM_B(-)	SynData	RTS	KeyData	Jump to Pin 1
7	Reserved	Reserved	CTS	TermClock	D -
8	Reserved	Reserved	Reserved	Reserved	Reserved
9	Reserved	Reserved	Reserved	Reserved	Reserved
10	Reserved	Reserved	Reserved	Reserved	Reserved

Figure 3-1 illustrates the positions of the cradle pins.

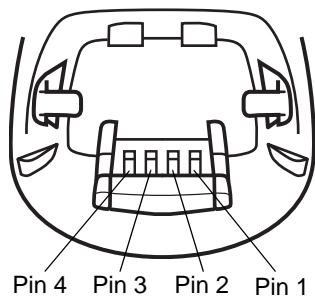

Figure 3-1 Cradle Pin Assignments

The signal descriptions in [Table 3-5](#) apply to the connector from the scanner to the cradle and are for reference only.

Table 3-5 Scanner to Cradle Pin-outs

Pin	Signal
1	VCC
2	CRADLE_TXD
3	CRADLE_RXD
4	GND

Chapter 4 Radio Communications

Introduction

This chapter provides information about the modes of operation and features available for wireless communication between scanners, cradles and hosts. The chapter also includes the parameters necessary to configure the scanner.

The scanner ships with the settings shown in the [Table 4-1 on page 4-2](#) (also see [Appendix A, Standard Default Parameters](#) for all host device and miscellaneous scanner defaults). If the default values suit requirements, programming is not necessary.

To set feature values, scan a single bar code or a short bar code sequence. The settings are stored in non-volatile memory and are preserved even when the scanner is powered down.

If not using a Synapse or USB cable with the cradle, select a host type (see each host chapter for specific host information) after the power-up beeps sound. This is only necessary upon the first power-up when connected to a new host.

To return all features to default values, scan a bar code in [Default Parameters on page 5-4](#). Throughout the programming bar code menus, default values are indicated with asterisks (*).



* Indicates Default — ***Disable Pair on Contacts** — Feature/Option

Scanning Sequence Examples

In most cases, scan one bar code to set a specific parameter value.

Errors While Scanning

Unless otherwise specified, to correct an error during a scanning sequence, just re-scan the correct parameter.

Radio Communications Parameter Defaults

Table 4-1 lists the defaults for radio communication parameters. If you wish to change any option, scan the appropriate bar code(s) provided in this chapter.

✓ **NOTE** See [Appendix A, Standard Default Parameters](#) for all user preferences, hosts, symbologies, and miscellaneous default parameters.

Table 4-1 *Radio Communication Default Table*

Parameter	Default	Page Number
Bluetooth Host (Host Type)	Cradle Host	4-5
Bluetooth Friendly Name	Scanner name and serial number	4-7
Discoverable Mode	General	4-7
Country Keyboard Types (Country Code)	North American	4-9
HID Keyboard Keystroke Delay	No Delay (0 msec)	4-11
CAPS Lock Override	Disable	4-11
Ignore Unknown Characters	Enable	4-12
Emulate Keypad	Disable	4-12
Keyboard FN1 Substitution	Disable	4-13
Function Key Mapping	Disable	4-13
Simulated Caps Lock	Disable	4-14
Convert Case	No Case Conversion	4-14
Beep on Reconnect Attempt	Disable	4-15
Reconnect Attempt Interval	30 sec	4-16
Auto-reconnect in Bluetooth Keyboard Emulation (HID Slave) Mode	On Bar Code Data	4-18
Modes of Operation (Point-to-Point/Multipoint-to-Point)	Point-to-Point	4-20
Parameter Broadcast (Cradle Host Only)	Enable	4-21
Pairing Modes	Unlocked	4-22
Pairing on Contacts	Disable	4-23
Connection Maintenance Interval	15 min	4-24

Table 4-1 Radio Communication Default Table (Continued)

Parameter	Default	Page Number
Authentication	Disable	4-27
Variable Pin Code	Static	4-28
Encryption	Disable	4-29

Wireless Beeper Definitions

When the scanner scans the pairing bar code it issues various beep sequences indicating successful or unsuccessful operations. See [Table 4-2](#) for beep sequences that occur during pairing operations.

Table 4-2 Wireless Beeper Definitions

Beeper Sequence	Indication
Short low-high beeps	Scanner has paired with the cradle.
Short high-low beeps	Scanner has unpaired with the cradle. Note: When connected to a remote device using SPP or HID, if a disconnect beep sequence sounds immediately after scanning a bar code, check the host device to determine if it received the transmitted data. The scanner may have transmitted the last bar code scanned after losing the connection.
Long low-long high beeps	Unsuccessful pairing attempt. See <i>Auto-reconnect Feature on page 4-15</i> .
Long low-long high-long low-long high beeps	Remote device rejected connection attempt, possibly due to an attempt to pair with a cradle that is already paired with the maximum number of scanners.
Four long low beeps	<ol style="list-style-type: none"> 1. A transmission error was detected in a scanned symbol. The data is ignored. This occurs if a unit is not properly configured. Check option setting. 2. When communicating with a cradle, the cradle acknowledges receipt of data. If the acknowledgment is not received, this transmission error beep sequence sounds. Data may still have been received by the host. Check the host system for receipt of transmitted data. If data was not received by the host, re-scan the bar code.
Five high beeps	Emitted every 5 seconds while a reconnection attempt is in progress. See <i>Auto-reconnect Feature on page 4-15</i> .

Radio Communications Host Types

To set up the scanner for communication with a cradle, or to use standard Bluetooth profiles, scan the appropriate host type bar code below.

- Cradle Host (default) - Select this host type for scanner(s) to cradle operation. The scanner must then be paired to the cradle and the cradle communicates directly to the host via the host interface cable connection.
- Serial Port Profile (Master) - Select this host type for Bluetooth Technology Profile Support (see [page 4-6](#)). The scanner connects to the PC/host via Bluetooth and behaves like there's a serial connection. The scanner initiates the connection to the remote device and is the Master. Scan **Serial Port Profile (Master)**, then scan the **PAIR** bar code for the remote device. See *Pairing Bar Code Format on page 4-24* for information about creating a pairing bar code for a remote device.
- Serial Port Profile (Slave) - Select this host type for Bluetooth Technology Profile Support (see [page 4-6](#)). The scanner connects to the PC/host via Bluetooth and behaves like there's a serial connection. The scanner accepts incoming connection requested from a remote device and is the Slave. Scan **Serial Port Profile (Slave)** and wait for the incoming connection.
- Bluetooth Keyboard Emulation (HID Slave) - Select this host type for Bluetooth Technology Profile Support. (See [page 4-6](#) for Bluetooth Technology Profile Support and Master/Slave definitions.) The scanner connects to the PC/host via Bluetooth and behaves like a keyboard. The scanner accepts incoming connection requested from a remote device and is the slave. Scan **Bluetooth Keyboard Emulation (HID Slave)** and wait for the incoming connection.



NOTE 1. The scanner supports keyboard emulation over the Bluetooth HID profile. For detailed information, and HID host parameters, see *HID Host Parameters on page 4-8*.

2. When the scanner is paired to the cradle in SPP Master or Cradle Host mode, the scanner automatically tries to reconnect to a remote device when a disconnection occurs that is due to the radio losing communication. For more information see *Auto-reconnect Feature on page 4-15*.

Radio Communications Host Types (continued)



***Cradle Host**



Serial Port Profile (Master)



Serial Port Profile (Slave)



Bluetooth Keyboard Emulation (HID Slave)

Bluetooth Technology Profile Support

With Bluetooth Technology Profile Support, the cradle is not required for wireless communication. The scanner communicates directly to the host using Bluetooth technology. The scanner supports the standard Bluetooth Serial Port Profile (SPP) and HID Profiles which enable the scanner to communicate with other Bluetooth devices that support these profiles.

- SPP - the scanner connects to the PC/host via Bluetooth and performs like there's a serial connection.
- HID - the scanner connects to the PC/host via Bluetooth and performs like a keyboard.

Master/Slave Set Up

The scanner can be set up as a Master or Slave.

When the scanner is set up as a Slave, it is discoverable and connectable to other devices. When the scanner is set up as a Master, the Bluetooth address of the remote device to which a connection is requested is required. A pairing bar code with the remote device address must be created and scanned to attempt a connection to the remote device. See the *Pairing Bar Code Format on page 4-24* for information about creating a pairing bar code.

Master

When the scanner is set up as a Master (SPP), it initiates the radio connection to a slave device. Initiating the connection is done by scanning a pairing bar code for the remote device (see *Pairing Bar Code Format on page 4-24*).

Slave

When the scanner is set up as a Slave device (SPP or HID), the scanner accepts an incoming connection request from a remote device.



NOTE The number of scanners is dependent on the host's capability.

Bluetooth Friendly Name

You can set a meaningful name for the scanner that appears in the application during device discovery. The default name is the scanner name followed by its serial number, e.g., **LS3578 123456789ABCDEF**. Scanning **Set Defaults** reverts the scanner to this name; use custom defaults to maintain the user-programmed name through a **Set Defaults** operation.

To set a new Bluetooth Friendly Name, scan the following bar code, then scan up to 23 characters from [Appendix E, Alphanumeric Bar Codes](#). If the name contains less than 23 characters, scan [End of Message on page E-7](#) after entering the name.



NOTE If your application allows you to set a device name, this takes precedence over the Bluetooth Friendly Name.



Bluetooth Friendly Name

Discoverable Mode

Select a discoverable mode based on the device initiating discovery:

- Select **General Discoverable Mode** when initiating connection from a PC.
- Select **Limited Discoverable Mode** when initiating connection from a mobile device (e.g., Motorola Q), and the device does not appear in General Discoverable Mode. Note that it can take longer to discover the device in this mode.

The device remains in Limited Discoverable Mode for 30 seconds, and green LEDs flash while in this mode. It is then non-discoverable. To re-active Limited Discoverable Mode, press the trigger.



***General Discoverable Mode**



Limited Discoverable Mode

HID Host Parameters

The scanner supports keyboard emulation over the Bluetooth HID profile. In this mode the scanner can interact with Bluetooth enabled hosts supporting the HID profile as a Bluetooth keyboard. Scanned data is transmitted to the host as keystrokes.

Following are the keyboard parameters supported by the HID host.

HID Country Keyboard Types (Country Codes)

Scan the bar code corresponding to the keyboard type.



***North American Standard Keyboards**

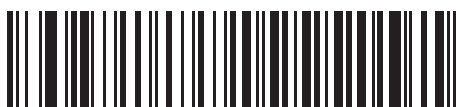

French Windows



German Windows



French Canadian Windows 98



Spanish Windows



Italian Windows

HID Country Keyboard Types (Country Codes - continued)



Swedish Windows



UK English Windows



Japanese Windows



French Canadian Windows 2000/XP



Portuguese/Brazilian Windows

HID Keyboard Keystroke Delay

This parameter sets the delay, in milliseconds, between emulated keystrokes. Scan a bar code below to increase the delay when the HID host requires a slower transmission of data.



***No Delay (0 msec)**



Medium Delay (20 msec)



Long Delay (40 msec)

HID CAPS Lock Override

When enabled, the case of the data is preserved regardless of the state of the caps lock key. This setting is always enabled for the “Japanese, Windows (ASCII)” keyboard type and can not be disabled.



***Do Not Override Caps Lock Key
(Disable)**



**Override Caps Lock Key
(Enable)**

HID Ignore Unknown Characters

Unknown characters are characters the host does not recognize. When **Send Bar Codes With Unknown Characters** is scanned, all bar code data is sent except for unknown characters, and no error beeps sound. When **Do Not Send Bar Codes With Unknown Characters** is scanned, bar codes containing at least one unknown character are not sent to the host, and an error beep sounds.



***Send Bar Codes With Unknown Characters
(Enable)**



**Do Not Send Bar Codes With Unknown Characters
(Disable)**

Emulate Keypad

When enabled, all characters are sent as ASCII sequences over the numeric keypad. For example, ASCII A is sent as "ALT make" 0 6 5 "ALT Break."



***Disable Keypad Emulation**



Enable Keypad Emulation

HID Keyboard FN1 Substitution

When enabled, this parameter allows replacement of any FN1 character in an EAN128 bar code with a Key Category and value chosen by the user. See [FN1 Substitution Values on page 5-15](#) to set the Key Category and Key Value.



***Disable Keyboard FN1 Substitution**



Enable Keyboard FN1 Substitution

HID Function Key Mapping

ASCII values under 32 are normally sent as control-key sequences. When this parameter is enabled, the keys in bold are sent in place of the standard key mapping (see [Table 8-2 on page 8-13](#)). Table entries that do not have a bold entry remain the same whether or not this parameter is enabled.



***Disable Function Key Mapping**



Enable Function Key Mapping

Simulated Caps Lock

When enabled, the scanner inverts upper and lower case characters on the scanner bar code as if the Caps Lock state is enabled on the keyboard. This inversion is done regardless of the current state of the keyboard Caps Lock state.



***Disable Simulated Caps Lock**



Enable Simulated Caps Lock

Convert Case

When enabled, the scanner converts all bar code data to the selected case.



***No Case Conversion**



Convert All to Upper Case



Convert All to LowerCase

Auto-reconnect Feature

When in SPP Master or Cradle Host mode, the scanner automatically tries to reconnect to a remote device when a disconnection occurs that is due to the radio losing communication. This can happen if the scanner goes out of range with the remote device, or if the remote device powers down. The scanner tries to reconnect for the period of time specified by the Reconnect Attempt Interval setting. During that time the green LED continues to blink.

If the auto-reconnect process fails due to page timeouts, the scanner sounds a page timeout beep (long low/long high) and enters low power mode. The auto-reconnect process can be re-started by pulling the scanner trigger.

If the auto-reconnect process fails because the remote device rejects the connection attempt, the scanner sounds a connection reject beep sequence (see *Wireless Beeper Definitions on page 4-3*) and deletes the remote pairing address. If this happens, a pairing bar code must be scanned to attempt a new connection to the remote device.

- ✓ **NOTE** If a bar code is scanned while the auto-reconnect sequence is in process, a transmission error beep sequence sounds and the data is not transmitted to the host. After a connection is reestablished, normal scanning operation returns. For error beep sequence definitions, see *Beeper Definitions on page 2-1*.

The scanner has memory available for storing a remote Bluetooth address for each Master mode (SPP, Cradle). When switching between these modes, the scanner automatically tries to reconnect to the last device it was connected to in that mode.

- ✓ **NOTE** Switching between Bluetooth host types by scanning a host type bar code (*page 4-4*) causes the radio to be reset. Scanning is disabled during this time. It takes several seconds for the scanner to re-initialize the radio at which time scanning is enabled.

Reconnect Attempt Beep Feedback

When a scanner disconnects as it goes out of range, it immediately attempts to reconnect. While the scanner attempts to reconnect, the green LED continues to blink. If the auto-reconnect process fails, the scanner emits a page timeout beep (long low/long high) and stops blinking the LED. The process can be restarted by pulling the trigger.

The Beep on Reconnect Attempt feature is disabled by default. When enabled, the scanner emits 5 short high beeps every 5 seconds while the reconnection attempt is in progress.

Scan a bar code below to enable or disable Beep on Reconnect Attempt.



***Disable Beep on Reconnect Attempt**



Enable Beep on Reconnect Attempt

Reconnect Attempt Interval

When a scanner disconnects as it goes out of range, it immediately attempts to reconnect for the default time interval of 30 seconds. This time interval can be changed to one of the following options:

- 30 seconds
- 1 minute
- 5 minutes
- 30 minutes
- 1 hour
- Indefinitely.

To set the Reconnect Attempt Interval, scan one of the bar codes below



***Attempt to Reconnect for 30 Seconds**



Attempt to Reconnect for 1 Minute



Attempt to Reconnect for 5 Minutes



Attempt to Reconnect for 30 Minutes

Reconnect Attempt Interval (continued)



Attempt to Reconnect for 1 Hour



Attempt to Reconnect Indefinitely

Auto-reconnect in Bluetooth Keyboard Emulation (HID Slave) Mode

In Bluetooth Keyboard Emulation (HID Slave) mode, select a re-connect option for when the scanner loses its connection with a remote device:

- **Auto-reconnect on Bar Code Data:** The scanner auto-reconnects when you scan a bar code. With this option, a delay can occur when transmitting the first characters. The scanner sounds a decode beep upon bar code scan, followed by a connection, a page timeout, a rejection beep, or a transmission error beep. Select this option to optimize battery life on the scanner and mobile device. Note that auto-reconnect does not occur on rejection and cable unplug commands.
- **Auto-reconnect Immediately:** When the scanner loses connection, it attempts to reconnect. If a page timeout occurs, the scanner attempts reconnect on a trigger pull. Select this option if the scanner's battery life is not an issue and you do not want a delay to occur when the first bar code is transmitted. Note that auto-reconnect does not occur on rejection and cable unplug commands.
- **Disable Auto-reconnect in Bluetooth Keyboard Emulation (HID Slave) Mode:** When the scanner loses connection, you must re-establish it manually.

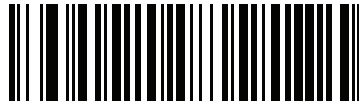

***Auto-reconnect on Bar Code Data**



Auto-reconnect Immediately



**Disable Auto-reconnect in
Bluetooth Keyboard Emulation (HID Slave) Mode**

Out of Range Indicator

An out of range indicator can be set by scanning *Enable Beep on Reconnect Attempt* on page 4-15 and extending the time using the *Reconnect Attempt Interval* on page 4-16.

For example, with Beep on Reconnect Attempt disabled while the scanner loses radio connection when it is taken out of range, the scanner attempts to reconnect silently during the time interval set by scanning a Reconnect Attempt Interval.

When Beep on Reconnect Attempt is enabled, the scanner emits 5 high beeps every 5 seconds while the reconnection attempt is in progress. If the Reconnect Attempt Interval is adjusted to a longer period of time, such as 30 minutes, the scanner emits 5 high beeps every 5 seconds for 30 minutes providing an out of range indicator.

Scanner(s) To Cradle Support

Modes of Operation

The charging cradle with radio supports two radio communication modes of operation, allowing the scanner to communicate wirelessly:

- Point-to-Point
- Multipoint-to-Point.

Point-to-Point Communication

In Point-to-Point communication mode, the cradle allows one scanner to connect to it at a time. In this mode, the scanner is paired to the cradle either by insertion into the cradle (if pairing on contacts is enabled, [page 4-23](#)), or by scanning the **PAIR** bar code on the cradle. Communication can be locked, unlocked (default), or in a lock override state (see *Pairing Modes on page 4-22*). In locked mode, locking intervals must be set by scanning a connection maintenance interval bar code beginning on [page 4-24](#).

To activate this mode of operation, scan **Point-to-Point**.

Multipoint-to-Point Communication

In Multipoint-to-Point communication mode, up to three scanners can be paired to one cradle.

To activate this mode, the first scanner connected to the cradle must scan the **Multipoint-to-Point** bar code. This mode allows a parameter broadcast ([page 4-21](#)) that clones all scanners paired to the cradle so only one scanner needs to be programmed.

To select Point-to-Point or Multipoint-to-Point mode, scan the appropriate bar code.



Multipoint-to-Point Mode



***Point-to-Point Mode**

Parameter Broadcast (Cradle Host Only)

When in multipoint-to-point mode, enable Parameter Broadcast to broadcast all parameter bar codes scanned to all other scanners in the piconet. If disabled, parameter bar codes are processed by the individual scanner only, and the scanner ignores parameters broadcast from other scanners or from the cradle.



***Enable Parameter Broadcast**



Disable Parameter Broadcast

Pairing

Pairing is the process by which a scanner initiates communication with a cradle. Scanning **Multipoint-to-Point** activates multi scanner-to-cradle operation and allows up to three scanners to pair to one cradle. The cradle includes a pairing bar code.

To pair the scanner with the cradle, scan the pairing bar code on the cradle. A high/low/high/low beep sequence indicates that the pairing bar code was decoded. When a connection between the cradle and scanner is established, a low/high beep sounds.

- ✓ **NOTE**
1. The pairing bar code that connects the scanner to a cradle is unique to each cradle.
 2. Do not scan data or parameters until pairing completes.
 3. When the scanner is paired to the cradle in SPP Master or Cradle Host mode, the scanner automatically tries to reconnect to a remote device when a disconnection occurs that is due to the radio losing communication. For more information see *Auto-reconnect Feature on page 4-15*.

Pairing Modes

When operating with the cradle, two modes of pairing are supported:

- **Locked Pairing Mode** - When a cradle is paired (connected) to the scanner (or to three scanners in Multipoint-to-Point mode), any attempt to connect a different scanner, by either scanning the **PAIR** bar code on the cradle or by inserting it into the cradle with the pairing on contacts feature enabled ([page 4-23](#)), is rejected. The currently connected scanner(s) maintain connection. In this mode, you must set a *Connection Maintenance Interval* on [page 4-24](#).
- **Unlocked Pairing Mode** - Pair (connect) a new scanner to a cradle at any time by either scanning the **PAIR** bar code on the cradle or by inserting it into the cradle with the pairing on contacts feature enabled. This unpairs the previous scanner from the cradle.

✓ **NOTE** In Multipoint-to-Point mode, pairing a 4th scanner while in Unlocked mode replaces any disconnected (out of range) scanner. However, if three scanners are actively connected to the cradle, a 4th scanner cannot connect regardless of the pairing mode.

To set the cradle pairing mode, scan the appropriate bar code below.



***Unlocked Pairing Mode**



Locked Pairing Mode

Lock Override

Lock Override overrides a locked scanner base pairing and connects a new scanner. In Multipoint-to-Point mode, this unpairs any disconnected (out of range) scanner first, in order to connect the new scanner.

To use **Lock Override**, scan the bar code below, followed by the pairing bar code on the cradle.



LockOverride

Pairing Methods

There are two pairing methods. The default method allows the scanner and cradle to pair (connect) when the pairing bar code on the cradle is scanned. A second method pairs the scanner and cradle when the scanner is inserted in the cradle. To enable this feature, scan **Enable Pair On Contacts** below. With this feature enabled it is not necessary to scan the pairing bar code on the cradle. If the pairing is successful, a low/high connection beep sequence sounds a few seconds after the scanner is placed in the cradle. See *Wireless Beeper Definitions on page 4-3* for other beep sequences.

To enable or disable pairing on contacts, scan the appropriate bar code below.



Enable Pair On Contacts



***Disable Pair on Contacts**

Unpairing

Unpair the scanner from the cradle or PC/host to make the cradle available for pairing with another scanner. Scan the bar code below to disconnect the scanner from its cradle/PC host.

An unpairing bar code is also included in the *LS3578 Quick Start Guide*.



Unpairing

Pairing Bar Code Format

When the scanner is configured as an SPP Master, you must create a pairing bar code for the remote Bluetooth device to which the scanner can connect. You must know the Bluetooth address of the remote device. Pairing bar codes are Code 128 bar codes and are formatted as follows:

<Fnc 3>Bxxxxxxxxxxx

where:

- **B** (or **LNKB**) is the prefix
- xxxxxxxxxxxx represents the 12-character Bluetooth address.

Pairing Bar Code Example

If the remote device to which the scanner can connect has a Bluetooth address of 11:22:33:44:55:66, then the pairing bar code is:



Connection Maintenance Interval

- ✓ **NOTE** The Connection Maintenance Interval only applies in locked pairing mode (see [page 4-22](#)).

When a scanner disconnects from a cradle due to a Link Supervision Timeout, the scanner immediately attempts to reconnect to the cradle for 30 seconds. If the auto-reconnect process fails, it can be restarted by pulling the scanner trigger.

To guarantee that a disconnected scanner can reconnect when it comes back in range, the cradle reserves the connection for that scanner for a period of time defined by the Connection Maintenance Interval. If the cradle is supporting the maximum three scanners and one scanner disconnects, a fourth scanner cannot pair to the cradle during this interval. To connect another scanner, either wait until the connection maintenance interval expires then scan the **PAIR** bar code on the cradle with the new scanner; or scan **Lock Override** ([page 4-22](#)) with the new scanner then scan the **PAIR** bar code on the cradle.

- ✓ **NOTE** When the cradle supports the maximum three scanners, it stores the remote pairing address of each scanner in memory regardless of the scanner condition (e.g., discharged battery). When you want to change the scanners paired to the cradle, unpair each scanner currently connected to the cradle by scanning the [Unpairing](#) bar code prior and reconnect each appropriate scanner by scanning the PAIR bar code on the cradle.

Connection Maintenance Interval options are:

- 15 minutes
- 30 minutes
- One hour
- Two hours
- Four hours
- Eight hours

- 24 hours
- Indefinitely.

Considerations

The system administrator determines the Connection Maintenance Interval. A shorter interval allows new users to gain access to abandoned connections more quickly, but causes problems if users leave the work area for extended periods. A longer interval allows existing users to leave the work area for longer periods of time, but ties up the system for new users.

To avoid this conflict, users who are going off-shift can scan the unpair bar code on [page 4-23](#) to ignore the Connection Maintenance Interval and make the connection immediately available.

To set the Connection Maintenance Interval, scan one of the bar codes below.



***Set Interval to 15 Minutes**



Set Interval to 30 Minutes



Set Interval to 60 Minutes



Set Interval to 2 Hours

Connection Maintenance Interval (continued)



Set Interval to 4 Hours



Set Interval to 8 Hours



Set Interval to 24 Hours



Set Interval to Forever

Bluetooth Security

The scanner supports Bluetooth Authentication and Encryption. Authentication can be requested by either the remote device or the scanner. When Authentication is requested, the scanner uses its programmed PIN code to generate a link key. The scanner stores this link key upon pairing, so you do not have to re-enter the PIN code when moving in and out of range, switching profiles, or switching between devices (e.g., between the cradle and the application).

Once Authentication is complete, either device may then negotiate to enable Encryption.



NOTE A remote device can still request Authentication.

Authentication

To force Authentication with a remote device (including the cradle), scan the **Enable Authentication** bar code below. To prevent the scanner from forcing Authentication, scan the **Disable Authentication** bar code below.



Enable Authentication



***Disable Authentication**

PIN Code

To set the PIN code (e.g., password) on the scanner, scan the bar code below followed by five alphanumeric programming bar codes from [Appendix E, Alphanumeric Bar Codes](#). The default PIN code is **12345**.

If the scanner communicates with a cradle with security enabled, synchronize the PIN codes on the scanner and cradle. To achieve this, connect the scanner to the cradle when setting the PIN codes. If the scanner is not connected to a cradle, the PIN code change only takes effect on the scanner. If security is required between the scanner and cradle, and the PIN codes do not match, pairing fails. If the PIN codes are not synchronized, re-synchronize them by disabling security, establishing a connection to the cradle, and then programming a new PIN code.



Set PIN Code

Variable PIN Code

The default PIN code is the user-programmed Static PIN Code. Typically, however, HID connections require entering a Variable PIN Code. If, when attempting connection, the application presents a text box that includes a PIN, scan the **Variable PIN Code** bar code, then re-attempt connection. When you hear a beep indicating the scanner is waiting for an alphanumeric entry, enter the provided variable PIN using the *Alphanumeric Keyboard on page E-1*, then scan *End of Message on page E-7* if the code is less than 16 characters. The scanner discards the variable PIN code after connection.



***Static PIN Code**



Variable PIN Code

Encryption

✓ **NOTE** Authentication must be performed before Encryption can take effect.

To set up the scanner for enabling Encryption, scan **Enable Encryption**. To prevent the scanner from enabling Encryption, scan **Disable Encryption**. When enabled, the radio encrypts data.



Enable Encryption



*** Disable Encryption**

Chapter 5 User Preferences

Introduction

This chapter describes each user preference feature and provides the programming bar codes for selecting these features for the scanner.

The scanner ships with the settings shown in the *User Preferences Default Table on page 5-2* (also see [Appendix A, Standard Default Parameters](#) for all host device and miscellaneous scanner defaults). If the default values suit the requirements, programming is not necessary.

Set feature values by scanning single bar codes or short bar code sequences. The settings are stored in non-volatile memory and are preserved when the scanner powers down.

The scanner communicates with the host through the cradle. During scanner setup, the scanner is paired with a cradle, which is connected to the host through one of several interfaces (see *Pairing on page 1-10* and the applicable host interface chapter). Each cradle can pair with up to four scanners.

If not using a Synapse or USB cable, select the host type (see the specific host chapter) after the scanner emits power-up beeps. This is only done upon the first power-up when connecting to a new host.

✓ **NOTE** Disconnect the power supply before changing host cables or the scanner may not recognize the new host.

To return all features to their default values, scan a [Default Parameters](#) bar code on [page 5-4](#). Throughout the programming bar code menus, default values are indicated with asterisks (*).

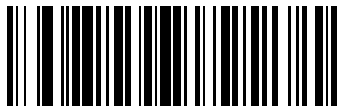

* Indicates Default — *High Frequency — Feature/Option

Scanning Sequence Examples

In most cases, scan only one bar code to set a parameter value. For example, to set the beeper tone to high, scan the **High Frequency** (beeper tone) bar code under *Beeper Tone on page 5-5*. The scanner issues a fast warble beep and the LED turns green, indicating a successful parameter entry.

Other parameters, such as **Laser On Time** or **Data Transmission Formats**, require scanning several bar codes. See the parameter description for this procedure.

Errors While Scanning

Unless otherwise specified, if an error is made during a scanning sequence, re-scan the correct parameter.

User Preferences Default Parameters

[Table 5-1](#) lists the defaults for user preference parameters. To change any option, scan the appropriate bar code(s) provided in [User Preferences on page 5-4](#).

✓ **NOTE** See [Appendix A, Standard Default Parameters](#) for all user preference, host, symbology, and miscellaneous default parameters..

Table 5-1 *User Preferences Default Table*

Parameter	Default	Page Number
User Preferences		
Default Parameters	Restore Defaults	5-4
Beeper Tone	Medium	5-5
Beeper Volume	High	5-6
Laser On Time	3.0 sec	5-7
Beep After Good Decode	Enable	5-7
Trigger Mode	Level	5-8
Aim Duration	0.0 sec	5-9
Beep on Insertion	Enable	5-9
Time Delay to Reduced Power Mode	1 Second	5-10
Transmit Code ID Character	None	5-11
Scan Angle	Normal Angle	5-11
Prefix Value	7013 <CR><LF>	5-12
Suffix Value	7013 <CR><LF>	5-12

Table 5-1 *User Preferences Default Table (Continued)*

Parameter	Default	Page Number
Scan Data Transmission Format	Data As Is	5-13
FN1 Substitution Values	Set FN1 Substitution Value	5-15
Transmit "No Read" Message	Disable No Read	5-15
Synapse Interface	Standard Synapse Connection	5-16
Batch Mode	Normal (Do Not Batch Data)	5-17
Report Scanner Version		5-19
Report Scan Engine Version		5-19
Report MIMIC Version		5-19
Report Synapse Cable		5-19

User Preferences

Default Parameters

The scanner can be reset to two types of defaults: factory defaults or custom defaults. Scan the appropriate bar code below to reset the scanner to its default settings and/or set the scanner's current settings as the custom default.

- **Restore Defaults** - Scan this bar code to reset all default parameters as follows:
 - If you configured custom default values (see **Write to Custom Defaults**), this sets the custom default values for all parameters.
 - If you did not configure custom default values, this sets the factory default values for all parameters. (For factory default values, see [Table A-1 on page A-1.](#))
- **Set Factory Defaults** - Scan this bar code to eliminate all custom default values and set the scanner to factory default values. (For factory default values, see [Table A-1 on page A-1.](#))
- **Write to Custom Defaults** - This bar code configures custom default parameters that set unique default values for all parameters. After changing all parameters to the desired default values, scan the **Write to Custom Defaults** bar code below to configure custom defaults.



NOTE Scanning **Restore Defaults** or **Set Factory Defaults** unpairs the scanner with the cradle, and you must rescan the pairing bar code.



***Restore Defaults**



Set Factory Defaults



Write to Custom Defaults

Beeper Tone

To select a decode beep frequency (tone), scan the **Low Frequency**, **Medium Frequency**, or **High Frequency** bar code.



Low Frequency



***Medium Frequency**

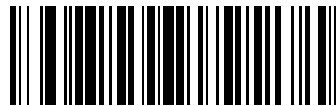

High Frequency

Beeper Volume

To select a beeper volume, scan the **Low Volume**, **Medium Volume**, or **High Volume** bar code.



Low Volume



Medium Volume



***High Volume**

Laser On Time

This parameter sets the maximum time that decode processing continues during a scan attempt. It is programmable in 0.1 second increments from 0.5 to 9.9 seconds. The default Laser On Time is 3.0 seconds.

To set a Laser On Time, scan the bar code below. Next, scan two numeric bar codes from [Appendix D, Numeric Bar Codes](#) that correspond to the desired on time. Include a leading zero for single digit numbers. For example, to set a Laser On Time of 0.5 seconds, scan the bar code below, then scan the **0** and **5** bar codes. To correct an error or change the selection, scan **Cancel** on [page D-3](#).



Laser On Time

Beep After Good Decode

Scan one of the following bar codes to select whether the scanner beeps after a good decode. If **Do Not Beep After Good Decode** is selected, the beeper still operates during parameter menu scanning and indicates error conditions.



*Beep After Good Decode
(Enable)



Do Not Beep After Good Decode
(Disable)

Trigger Mode

Scan one of the following bar codes to set the scanner's trigger mode.

Level Trigger

Upon trigger pull, an aiming dot appears for a programmable duration of time. After this time, the aiming dot turns into a standard laser scanning beam for a full decode session. The laser scanning beam stays on until the laser-on timeout occurs, a decode occurs, or the trigger is released. If the trigger is released before the aiming duration expires, the laser shuts off and no decode occurs.

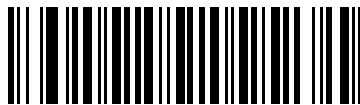

***Level**

Two Stage - Option 1

Upon trigger pull, an aiming dot appears. This aiming dot remains while the trigger is pulled. When the trigger is released, the aiming dot turns into a standard laser scanning beam for a full decode session. The laser scanning beam stays on until the laser-on timeout occurs or a decode occurs. If the trigger is pulled again while in a decode session, the scanner beam returns to an aiming dot.



Two Stage - Option 1

Two Stage - Option 2

Upon trigger pull, an aiming dot appears. When the trigger is released, the aiming dot turns off. Pulling the trigger twice quickly turns on the standard laser scanning beam for a full decode session. The laser scanning beam stays on until the laser-on timeout occurs, a decode occurs, or the trigger is released.

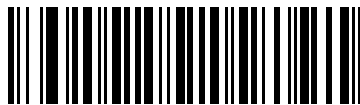

Two Stage - Option 2

Aim Duration

When the scanner is in Level trigger mode (default mode), Aim Duration sets the amount of time the aiming dot appears before turning into a scanning beam. This parameter has no effect when the scanner is in either of the Two Stage trigger modes. See *Trigger Mode on page 5-8* for a description of each of the trigger modes.

The aim duration is programmable in 0.1 second increments, from 0.0 to 9.9 seconds. The default Aim Duration is 0.0 seconds. When set to 0.0 seconds, no aiming pattern appears before a decode session.

To set an aim duration, scan the bar code below. Then scan two numeric bar codes from [Appendix D, Numeric Bar Codes](#) that correspond to the desired aim duration. Include a leading zero for durations less than 1.0 seconds. For example, to set an aim duration of 0.5 seconds, scan the bar code below followed by the **0** and the **5** bar codes. To correct an error or change the selection, scan **Cancel** on [page D-3](#).

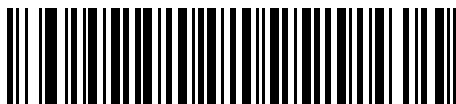

Aim Duration

Beep on Insertion

When a scanner is inserted into a cradle and detects power, it emits a short low beep by default. To enable or disable beeping on insertion, scan the appropriate bar code below.



*Enable Beep on Insertion



Disable Beep on Insertion

Time Delay to Reduced Power Mode

This parameter sets the time it takes the scanner to enter reduced power mode after any scanning activity. Scan the appropriate bar code below to set the time.



***1 second**



2 seconds



3 seconds



4 seconds



5 seconds

Transmit Code ID Character

A Code ID character identifies the code type of a scanned bar code. This is useful when the scanner is decoding more than one code type. Select a Code ID character to insert between the prefix and the decoded symbol.

Select no Code ID character, a Symbol Code ID character, or an AIM Code ID character. For Code ID Characters, see [Symbol Code Identifiers on page B-1](#) and [AIM Code Identifiers on page B-2](#).

✓ **NOTE** If you enable Symbol Code ID Character or AIM Code ID Character, and enable *Transmit "No Read" Message* on page 5-15, the scanner appends the code ID for Code 39 to the NR message.

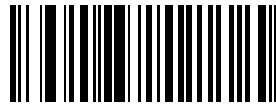

Symbol Code ID Character

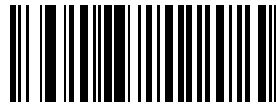

AIM Code ID Character

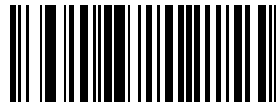

*None

Scan Angle

Scan one of the following bar codes to select a scan angle. This affects the length of the laser scanning beam.

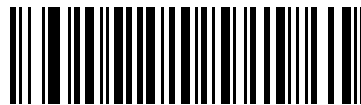

*Normal Angle



Alternate Angle

Prefix/Suffix Values

To append a prefix or suffix to scan data for use in data editing, scan the appropriate bar code, then scan a four-digit number (i.e., four numeric bar codes) from [Appendix D, Numeric Bar Codes](#) that corresponds to key codes for various terminals. For conversion information, see the ASCII Character Set tables in the appropriate host chapter. To correct an error or change the selection, scan **Cancel** on [page D-3](#).

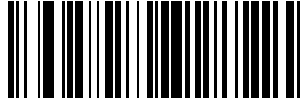

Scan Prefix



Scan Suffix

Scan Data Transmission Format

To change the Scan Data Transmission Format:

1. Scan the **Scan Options** bar code.
2. Select one of four options:
 - Data As Is
 - <DATA> <SUFFIX>
 - <PREFIX> <DATA>
 - <PREFIX> <DATA> <SUFFIX>
3. Scan the **Enter** bar code on [page 5-14](#).

To correct a mistake, scan the **Data Format Cancel** bar code on [page 5-14](#).

To program a carriage return/enter after each bar code scanned, scan the following bar codes in order:

1. <SCAN OPTIONS>
2. <DATA> <SUFFIX>
3. Enter (on [page 5-14](#))

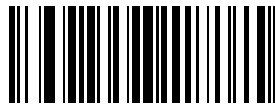

Scan Options

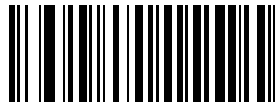

***Data As Is**



<DATA> <SUFFIX>

Scan Data Transmission Format (continued)

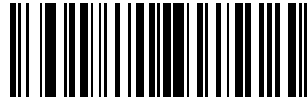

<PREFIX> <DATA>



<PREFIX> <DATA> <SUFFIX>

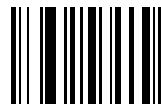

Enter



Data Format Cancel

FN1 Substitution Values

The keyboard wedge and USB HID keyboard hosts support a FN1 Substitution feature. Enable this to replace any FN1 character (0x1b) in an EAN128 bar code with a defined value. This value defaults to 7013 (Enter Key).

1. To select a FN1 substitution value, scan the following bar code.

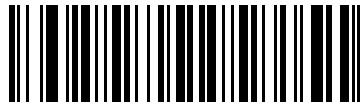

Set FN1 Substitution Value

2. Enter the 4-digit FN1 substitution (ASCII) value by scanning each digit in [Appendix D, Numeric Bar Codes](#). See the ASCII Character Set table for the host interface.

To correct an error or change the selection, scan **CANCEL**.

To enable FN1 Substitution for keyboard wedge, scan the **Enable Keyboard Wedge FN1 Substitution** bar code on [page 6-11](#).

To enable FN1 Substitution for the USB HID keyboard, scan the **Enable USB Keyboard FN1 Substitution** bar code on [page 8-10](#).

Transmit “No Read” Message

Scan one of the following bar codes to select whether or not to transmit a “No Read” message. When enabled, the characters NR transmit when a bar code is not decoded. When disabled, if a symbol does not decode, nothing transmits to the host.



NOTE If you enable **Transmit No Read**, and also enable Symbol Code ID Character or AIM Code ID Character for *Transmit Code ID Character on page 5-11*, the scanner appends the code ID for Code 39 to the NR message.



Enable No Read



***Disable No Read**

Synapse Interface

The auto-detection of a Synapse cable varies in duration depending on the type of Synapse connection. If connecting a scanner to another scanner using a Synapse cable, use the Auxiliary Synapse Port connection. Otherwise, when using a Synapse cable, use the default setting.

To disconnect and reconnect the scanner from a Synapse cable that is connected to a live host via Synapse, use the “Plug and Play” setting. Do not change this setting from the default if an on-board wedge host is enabled.

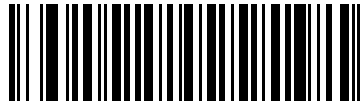

***Standard Synapse Connection**



Auxiliary Synapse Port Connection



“Plug and Play” Synapse Connection

Batch Mode

The scanner supports three versions of batch mode. When the scanner is configured for any of the batch modes, it attempts to store bar code data (not parameter bar codes) until transmission is initialized, or the maximum number of bar codes are stored. When a bar code is saved successfully, a good decode beep sounds and the LED flashes green. If the scanner is unable to store a new bar code, a low/high/low/high out of memory beep sounds. (See pages 2-1 and 2-4 for all beeper and LED definitions.)

In all modes, calculate the amount of data (number of bar codes) the scanner can store as follows:

$$\text{Number of storable bar codes} = 2,000 \text{ bytes of memory} / (\text{number of characters in the bar code} + 3).$$

Modes of Operation

- **Normal (default)** - Do not batch data. The scanner attempts to transmit every scanned bar code.
- **Out of Range Batch Mode** - The scanner starts storing bar code data when it loses its connection to a remote device (for example, when a user holding the scanner walks out of range). Data transmission is triggered by reestablishing the connection with the remote device (for example, when a user holding the scanner walks back into range).
- **Standard Batch Mode** - The scanner starts storing bar code data after **Enter Batch Mode** is scanned. Data transmission is triggered by scanning **Send Batch Data**.

✓ **NOTE** Transmission is halted if the connection to the remote device is lost.

- **Cradle Contact Batch Mode** - The scanner starts storing bar code data when **Enter Batch Mode** is scanned. Data transmission is triggered by insertion of the scanner into the cradle.

✓ **NOTE** If the scanner is removed from the cradle during batch data transfer, transmission halts until the scanner is re-inserted in the cradle.

In all modes, transmissions are halted if the scanner is moved out of range. The scanner resumes when it is back in range. If a bar code is scanned while batch data is transmitted it is appended to the end of the batched data; parameter bar codes are not stored.

Batch Mode (continued)



***Normal**



Out of Range Batch Mode



Standard Batch Mode



Cradle Contact Batch Mode



Enter Batch Mode



Send Batch Data

Report Scanner Version

Scan the bar code below to report the scanner's software revision.



Report Scanner Software Version

Report Scan Engine Version

Scan the bar code below to report the scan engine's software revision.



Report Scan Engine Software Version

Report MIMIC Version

Scan the bar code below to report the MIMIC software revision installed in the cradle's software. Scanners that do not use MIMIC architecture report nothing.



Report MIMIC Software Version

Report Synapse Cable

Scan the bar code below to report the software revision of the attached Synapse cable. If the scanner does not detect an attached Synapse cable, it reports *Synapse not attached*.



Report Synapse Cable

Chapter 6 Keyboard Wedge Interface

Introduction

This chapter provides instructions for programming the scanner for keyboard wedge host interface, used to connect the scanner between the keyboard and host computer. The scanner translates the bar code data into keystrokes, and transmits the information to the host computer via the cradle interface. The host computer accepts the keystrokes as if they originated from the keyboard.

This interface adds bar code reading functionality to a system designed for manual keyboard input. In this mode the keyboard keystrokes are simply passed through.

Throughout the programming bar code menus, default values are indicated with asterisks (*).



* Indicates Default — ***North American** — Feature/Option

Connecting a Keyboard Wedge Interface

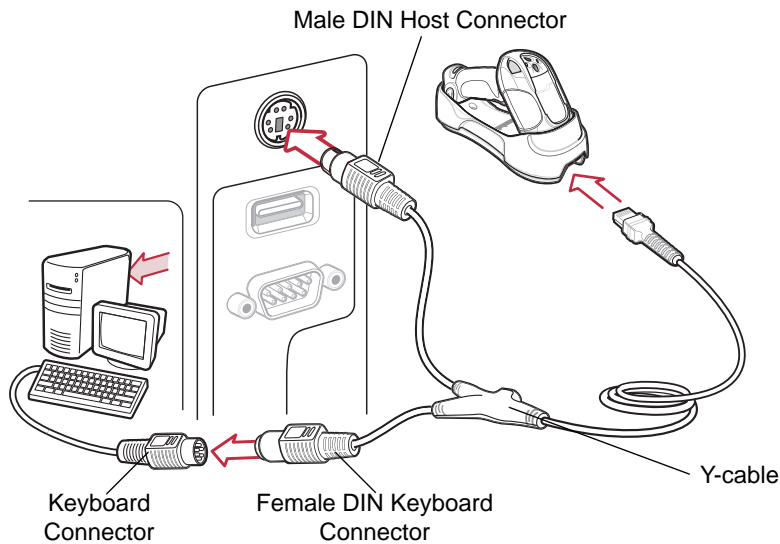

Figure 6-1 Keyboard Wedge Interface Connection with Y-cable

To connect the keyboard wedge interface Y-cable:

1. Turn off the host and unplug the keyboard connector.
2. Attach the modular connector of the Y-cable to the cable interface port on the cradle. See *Connecting the Cradle* on page 1-4.
3. Connect the round male DIN host connector of the Y-cable to the keyboard port on the host.
4. Connect the round female DIN keyboard connector of the Y-cable to the keyboard connector.
5. If required, connect the power supply to the cradle.
6. Ensure that all connections are secure.
7. Turn on the host system.
8. Pair the scanner to the cradle by scanning the bar code on the cradle.
9. Select the keyboard wedge host type by scanning the appropriate bar code from *Keyboard Wedge Host Types* on page 6-4.
10. To modify any other parameter options, scan the appropriate bar codes in this chapter.
11. Connect an external power supply if desired.

✓ **NOTE** Interface cables vary depending on configuration. The connectors illustrated in [Figure 6-1](#) are examples only. The connectors may be different from those illustrated, but the steps to connect the cradle remain the same.

✓ **NOTE** Disconnect the power supply before changing host cables or the scanner may not recognize the new host.

Keyboard Wedge Default Parameters

[Table 6-1](#) lists the defaults for keyboard wedge host parameters. To change any option, scan the appropriate bar code(s) provided in this chapter.

✓ **NOTE** See [Appendix A, Standard Default Parameters](#) for all user preference, host, symbology, and miscellaneous default parameters.

Table 6-1 Keyboard Wedge Host Default Table

Parameter	Default	Page Number
Keyboard Wedge Host Parameters		
Keyboard Wedge Host Type	IBM PC/AT& IBM PC Compatibles	6-4
Keyboard Wedge Country Types (Country Codes)	North American	6-5
Ignore Unknown Characters	Enable	6-7
Keystroke Delay	0 msec (No Delay)	6-7
Intra-Keystroke Delay	Disable	6-8
Alternate Numeric Keypad Emulation	Disable	6-8
Caps Lock On	Disable	6-9
Caps Lock Override	Disable	6-9
Convert Wedge Data	Do Not Convert Wedge Data	6-10
Function Key Mapping	Disable	6-10
FN1 Substitution	Disable	6-11
Send Make and Break	Send Make and Break Scan Codes	6-11

Keyboard Wedge Host Types

Keyboard Wedge Host Types

Select the keyboard wedge host by scanning one of the following bar codes.



***IBM PC/AT & IBM PC Compatibles**



IBM AT NOTEBOOK



NCR 7052

Keyboard Wedge Country Types (Country Codes)

Scan the bar code corresponding to the keyboard type. If the particular keyboard type is not listed, see *Alternate Numeric Keypad Emulation* on page 6-8.



***North American**



German Windows

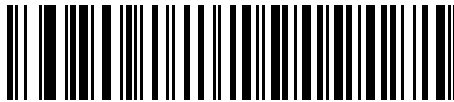

French Windows



French Canadian Windows 95/98

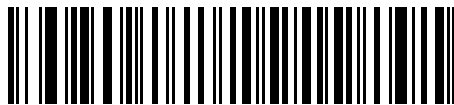

French Canadian Windows XP/2000



French Belgian Windows

Keyboard Wedge Country Types (Country Codes) (continued)



Spanish Windows



Italian Windows



Swedish Windows



UK English Windows



Japanese Windows

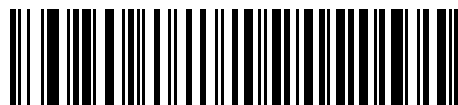

Brazilian-Portuguese Windows

Ignore Unknown Characters

Unknown characters are characters the host does not recognize. When **Send Bar Codes With Unknown Characters** is selected, all bar code data is sent except for unknown characters, and the scanner emits no error beeps. When **Do Not Send Bar Codes With Unknown Characters** is selected, bar code data is sent until the first unknown character is encountered, and the scanner emits an error beep.



***Send Bar Codes with Unknown Characters
(Enable)**

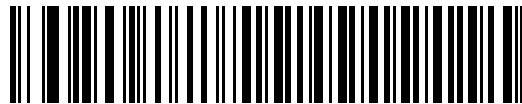

**Do Not Send Bar Codes with Unknown Characters
(Disable)**

Keystroke Delay

This is the delay in milliseconds between emulated keystrokes. Scan a bar code below to increase the delay when hosts require a slower data transmission.



***0 msec (No Delay)**



20 msec (Medium Delay)



40 msec (Long Delay)

Intra-Keystroke Delay

Enable Intra-Keystroke Delay to insert an additional delay between each emulated key press and release. This also sets the Keystroke Delay parameter to a minimum of 5 msec.



Enable Intra-Keystroke Delay

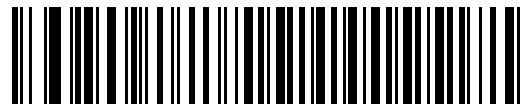

***Disable Intra-Keystroke Delay**

Alternate Numeric Keypad Emulation

This allows emulation of most other country keyboard types not listed in *Keyboard Wedge Country Types (Country Codes)* on page 6-5 in a Microsoft® operating system environment.



Enable Alternate Numeric Keypad



***Disable Alternate Numeric Keypad**

Caps Lock On

When enabled, the scanner emulates keystrokes as if the Caps Lock key is always pressed.

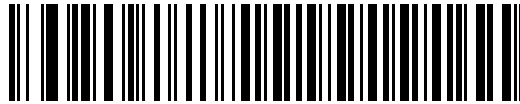

Enable Caps Lock On



***Disable Caps Lock On**

Caps Lock Override

When enabled, on AT or AT Notebook hosts, the keyboard ignores the state of the Caps Lock key and matches the case (upper or lower) of the sent character. Therefore, an upper case 'A' in the bar code is sent as an upper case 'A,' and a lower case 'a' in the bar code is sent as a lower case 'a,' no matter what the state of the keyboard's Caps Lock key.



Enable Caps Lock Override



***Disable Caps Lock Override**



NOTE If both Caps Lock On and Caps Lock Override are enabled, Caps Lock Override takes precedence.

Convert Wedge Data

When enabled, the scanner converts all bar code data to the selected case.

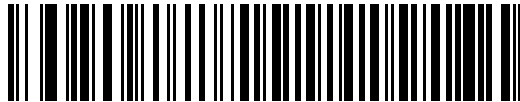

Convert Wedge Data to Upper Case

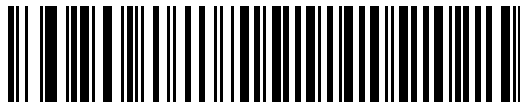

Convert Wedge Data to Lower Case



***Do Not Convert Wedge Data**

Function Key Mapping

ASCII values under 32 are normally sent as control key sequences (see [Table 6-2 on page 6-14](#)). Enable this parameter to send the keys in bold in place of the standard key mapping. Table entries that do not have a bold entry remain the same regardless of this parameter.

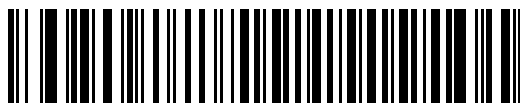

Enable Function Key Mapping

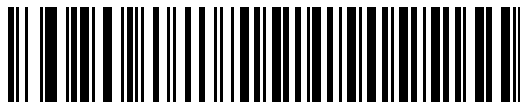

***Disable Function Key Mapping**

FN1 Substitution

When enabled, this parameter replaces any FN1 character in an EAN128 bar code with a keystroke chosen by the user. See *FN1 Substitution Values on page 5-15*.

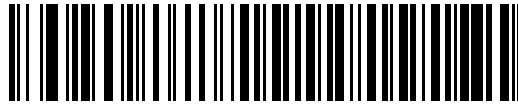

Enable FN1 Substitution



***Disable FN1 Substitution**

Send Make and Break

When enabled, the scan codes for releasing a key are not sent.

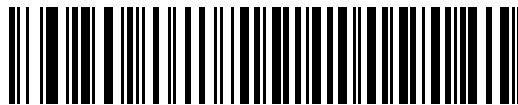

***Send Make and Break Scan Codes**

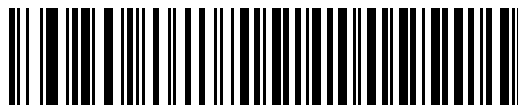

Send Make Scan Code Only

Keyboard Maps

The following keyboard maps are provided for prefix/suffix keystroke parameters. To program the prefix/suffix values, see the bar codes on [page 5-12](#).

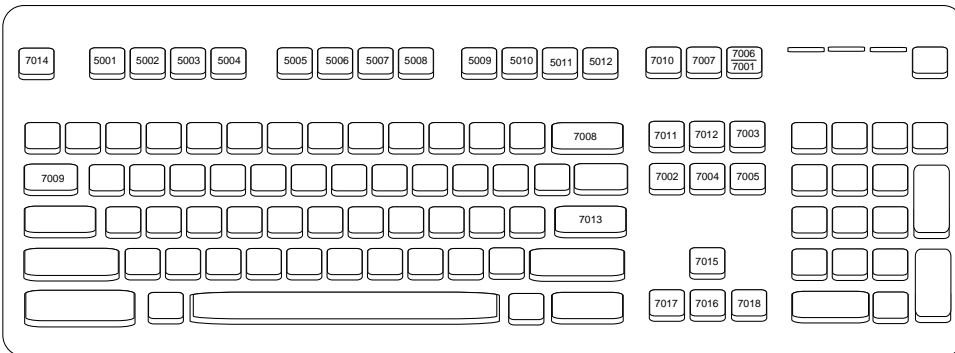

Figure 6-2 IBM PS2 Type Keyboard

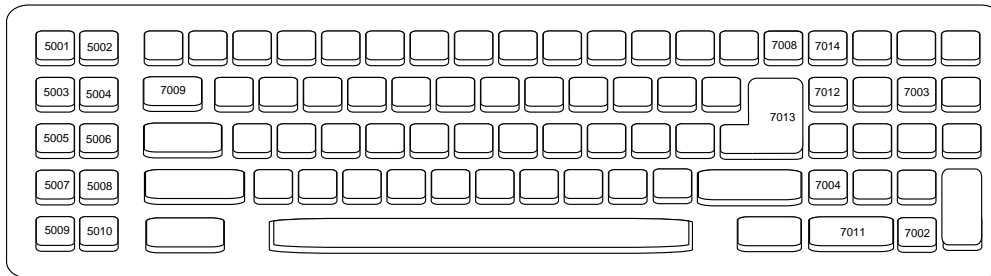

Figure 6-3 IBM PC/AT

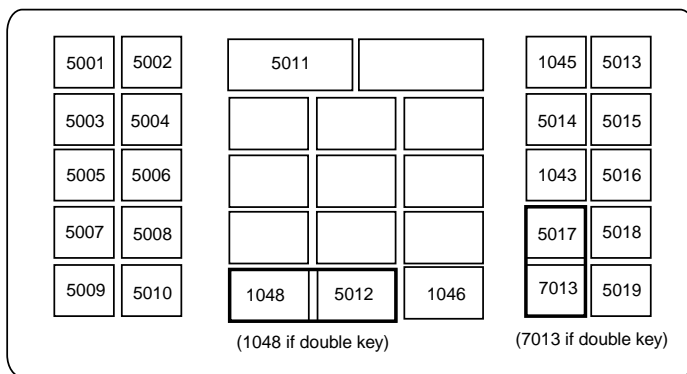

Figure 6-4 NCR 7052 32-KEY

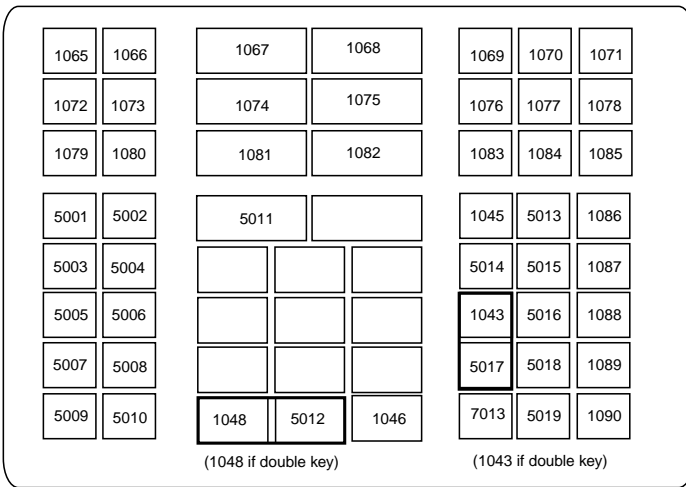

Figure 6-5 NCR 7052 58-KEY

ASCII Character Set

- ✓ **NOTE** Code 39 Full ASCII interprets the bar code special character (\$ + % /) preceding a Code 39 character and assigns an ASCII character value to the pair. For example, when Code 39 Full ASCII is enabled and a +B is scanned, it is interpreted as b, %J as ?, and %V as @. Scanning ABC%i outputs the keystroke equivalent of ABC >.

Table 6-2 Keyboard Wedge ASCII Character Set

ASCII Value	Full ASCII Code 39 Encode Character	Keystroke
1001	\$A	CTRL A
1002	\$B	CTRL B
1003	\$C	CTRL C
1004	\$D	CTRL D
1005	\$E	CTRL E
1006	\$F	CTRL F
1007	\$G	CTRL G
1008	\$H	CTRL H/ BACKSPACE ¹
1009	\$I	CTRL I/ HORIZONTAL TAB ¹
1010	\$J	CTRL J
1011	\$K	CTRL K
1012	\$L	CTRL L
1013	\$M	CTRL M/ ENTER ¹
1014	\$N	CTRL N
1015	\$O	CTRL O
1016	\$P	CTRL P
1017	\$Q	CTRL Q
1018	\$R	CTRL R
1019	\$S	CTRL S
1020	\$T	CTRL T

¹The keystroke in bold is sent only if the "Function Key Mapping" is enabled. Otherwise, the unbolded keystroke is sent.

Table 6-2 Keyboard Wedge ASCII Character Set (Continued)

ASCII Value	Full ASCII Code 39 Encode Character	Keystroke
1021	\$U	CTRL U
1022	\$V	CTRL V
1023	\$W	CTRL W
1024	\$X	CTRL X
1025	\$Y	CTRL Y
1026	\$Z	CTRL Z
1027	%A	CTRL [/ESC ¹
1028	%B	CTRL \
1029	%C	CTRL]
1030	%D	CTRL 6
1031	%E	CTRL -
1032	Space	Space
1033	/A	!
1034	/B	“
1035	/C	#
1036	/D	\$
1037	/E	%
1038	/F	&
1039	/G	‘
1040	/H	(
1041	/I)
1042	/J	*
1043	/K	+
1044	/L	,
1045	-	-
1046	.	.
1047	/O	/

¹The keystroke in bold is sent only if the “Function Key Mapping” is enabled. Otherwise, the unbolded keystroke is sent.

Table 6-2 Keyboard Wedge ASCII Character Set (Continued)

ASCII Value	Full ASCII Code 39 Encode Character	Keystroke
1048	0	0
1049	1	1
1050	2	2
1051	3	3
1052	4	4
1053	5	5
1054	6	6
1055	7	7
1056	8	8
1057	9	9
1058	/Z	:
1059	%F	;
1060	%G	<
1061	%H	=
1062	%I	>
1063	%J	?
1064	%V	@
1065	A	A
1066	B	B
1067	C	C
1068	D	D
1069	E	E
1070	F	F
1071	G	G
1072	H	H
1073	I	I
1074	J	J

¹The keystroke in bold is sent only if the “Function Key Mapping” is enabled. Otherwise, the unbolded keystroke is sent.

Table 6-2 Keyboard Wedge ASCII Character Set (Continued)

ASCII Value	Full ASCII Code 39 Encode Character	Keystroke
1075	K	K
1076	L	L
1077	M	M
1078	N	N
1079	O	O
1080	P	P
1081	Q	Q
1082	R	R
1083	S	S
1084	T	T
1085	U	U
1086	V	V
1087	W	W
1088	X	X
1089	Y	Y
1090	Z	Z
1091	%K	[
1092	%L	\
1093	%M]
1094	%N	^
1095	%O	_
1096	%W	'
1097	+A	a
1098	+B	b
1099	+C	c
1100	+D	d
1101	+E	e

¹The keystroke in bold is sent only if the "Function Key Mapping" is enabled. Otherwise, the unbolded keystroke is sent.

Table 6-2 Keyboard Wedge ASCII Character Set (Continued)

ASCII Value	Full ASCII Code 39 Encode Character	Keystroke
1102	+F	f
1103	+G	g
1104	+H	h
1105	+I	i
1106	+J	j
1107	+K	k
1108	+L	l
1109	+M	m
1110	+N	n
1111	+O	o
1112	+P	p
1113	+Q	q
1114	+R	r
1115	+S	s
1116	+T	t
1117	+U	u
1118	+V	v
1119	+W	w
1120	+X	x
1121	+Y	y
1122	+Z	z
1123	%P	{
1124	%Q	
1125	%R	}
1126	%S	~

¹The keystroke in bold is sent only if the "Function Key Mapping" is enabled. Otherwise, the unbolded keystroke is sent.

Table 6-3 Keyboard Wedge ALT Key Character Set

ALT Keys	Keystroke
2065	ALT A
2066	ALT B
2067	ALT C
2068	ALT D
2069	ALT E
2070	ALT F
2071	ALT G
2072	ALT H
2073	ALT I
2074	ALT J
2075	ALT K
2076	ALT L
2077	ALT M
2078	ALT N
2079	ALT O
2080	ALT P
2081	ALT Q
2082	ALT R
2083	ALT S
2084	ALT T
2085	ALT U
2086	ALT V
2087	ALT W
2088	ALT X
2089	ALT Y
2090	ALT Z

Table 6-4 Keyboard Wedge GUI Key Character Set

GUI Keys	Keystrokes
3000	Right Control Key
3048	GUI 0
3049	GUI 1
3050	GUI 2
3051	GUI 3
3052	GUI 4
3053	GUI 5
3054	GUI 6
3055	GUI 7
3056	GUI 8
3057	GUI 9
3065	GUI A
3066	GUI B
3067	GUI C
3068	GUI D
3069	GUI E
3070	GUI F
3071	GUI G
3072	GUI H
3073	GUI I
3074	GUI J
3075	GUI K
3076	GUI L
3077	GUI M
3078	GUI N
3079	GUI O
3080	GUI P
3081	GUI Q
3082	GUI R
3083	GUI S

Table 6-4 Keyboard Wedge GUI Key Character Set (Continued)

GUI Keys	Keystrokes
3084	GUI T
3085	GUI U
3086	GUI V
3087	GUI W
3088	GUI X
3089	GUI Y
3090	GUI Z

Table 6-5 Keyboard Wedge F Key Character Set

F Keys	Keystroke
5001	F1
5002	F2
5003	F3
5004	F4
5005	F5
5006	F6
5007	F7
5008	F8
5009	F9
5010	F10
5011	F11
5012	F12
5013	F13
5014	F14
5015	F15
5016	F16
5017	F17
5018	F18
5019	F19
5020	F20

Table 6-5 Keyboard Wedge F Key Character Set (Continued)

F Keys	Keystroke
5021	F21
5022	F22
5023	F23
5024	F24

Table 6-6 Keyboard Wedge Numeric Keypad Character Set

Numeric Keypad	Keystroke
6042	*
6043	+
6044	undefined
6045	-
6046	.
6047	/
6048	0
6049	1
6050	2
6051	3
6052	4
6053	5
6054	6
6055	7
6056	8
6057	9
6058	Enter
6059	Num Lock

Table 6-7 *Keyboard Wedge Extended Keypad Character Set*

Extended Keypad	Keystroke
7001	Break
7002	Delete
7003	Pg Up
7004	End
7005	Pg Dn
7006	Pause
7007	Scroll Lock
7008	Backspace
7009	Tab
7010	Print Screen
7011	Insert
7012	Home
7013	Enter
7014	Escape
7015	Up Arrow
7016	Dn Arrow
7017	Left Arrow
7018	Right Arrow

Chapter 7 RS-232 Interface

Introduction

This chapter provides instructions for programming the scanner to interface with an RS-232 host interface. The RS-232 interface is used to attach the cradle to point-of-sale devices, host computers, or other devices with an available RS-232 port (i.e., COM port).

If the particular host is not listed in [Table 7-2](#), set the communication parameters to match the host device. Refer to the documentation for the host device.

- ✓ **NOTE** This scanner uses TTL RS-232 signal levels, which interface with most system architectures. For system architectures requiring RS-232C signal levels, Motorola offers different cables providing the TTL to RS-232C conversion. Contact the Motorola Solutions Global Customer Support Center for more information.

Throughout the bar code menus, default values are indicated with asterisks (*).

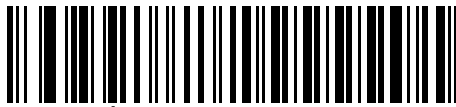

* Indicates Default — *Baud Rate 9600 — Feature/Option

Connecting an RS-232 Interface

This connection is made directly from the cradle to the host computer.

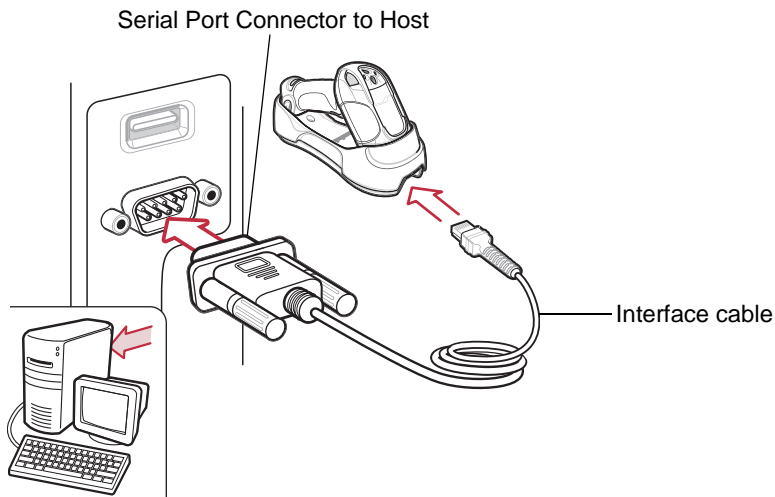

Figure 7-1 RS-232 Direct Connection

- ✓ **NOTE** Interface cables vary depending on configuration. The connectors illustrated in [Figure 7-1](#) are examples only. The connectors may be different from those illustrated, but the steps to connect the cradle remain the same.

 - ✓ **NOTE** Disconnect the power supply before changing host cables or the scanner may not recognize the new host.
1. Attach the modular connector of the RS-232 interface cable to the cable interface port on the cradle. See *Connecting the Cradle* on page 1-4.
 2. Connect the other end of the RS-232 interface cable to the serial port on the host.
 3. If required, connect the power supply to the cradle.
 4. Ensure that all connections are secure.
 5. Pair the scanner to the cradle by scanning the bar code on the cradle.
 6. Select the RS-232 host type by scanning the appropriate bar code from *RS-232 Host Types* on page 7-6.
 7. To modify any other parameter options, scan the appropriate bar codes in this chapter.

RS-232 Default Parameters

Table 7-1 lists the defaults for RS-232 host parameters. To change any option, scan the appropriate bar code(s) provided in the parameter descriptions section beginning on [page 7-4](#).

✓ **NOTE** See [Appendix A, Standard Default Parameters](#) for all user preference, host, symbology, and miscellaneous default parameters.

Table 7-1 *RS-232 Host Default Table*

Parameter	Default	Page Number
RS-232 Host Parameters		
RS-232 Host Types	Standard RS-232	7-6
Baud Rate	9600	7-7
Parity	None	7-9
Check Receive Errors	Enable	7-10
Stop Bit Select	1 Stop Bit	7-11
Data Bits	8-Bit	7-11
Hardware Handshaking	None	7-12
Software Handshaking	None	7-14
Host Serial Response Time-out	Minimum: 2 sec	7-16
RTS Line State	Host: Low RTS	7-17
Beep on <BEL>	Disable	7-17
Intercharacter Delay	Minimum: 0 msec	7-18
Nixdorf Beep/LED Options	Normal Operation	7-19
Ignore Unknown Characters	Send Bar Code	7-20

RS-232 Host Parameters

Various RS-232 host types are set up with their own parameter default settings. Selecting the host type sets the parameter defaults as listed in [Table 7-2](#).

Table 7-2 Terminal Specific RS-232

Parameter	Standard RS-232 (Default)	ICL	Wincor-Nixdorf Mode A	Wincor-Nixdorf Mode B	Olivetti	Omron	OPOS/JPOS	Fujitsu
Transmit Code ID	No	Yes	Yes	Yes	Yes	Yes	Yes	Yes
Data Transmission Format	Data as is	Data/Suffix	Data/Suffix	Data/Suffix	Prefix/Data/Suffix	Data/Suffix	Data/Suffix	Data/Suffix
Suffix	CR/LF (7013)	CR (1013)	CR (1013)	CR (1013)	ETX (1002)	CR (1013)	CR (1013)	CR (1013)
Baud Rate	9600	9600	9600	9600	9600	9600	9600	9600
Parity	None	Even	Odd	Odd	Even	None	Odd	None
Hardware Handshaking	None	RTS/CTS Option 3	RTS/CTS Option 3	RTS/CTS Option 3	None	None	RTS/CTS Option 3	None
Software Handshaking	None	None	None	None	Ack/Nak	None	None	None
Serial Response Time-out	2 Sec.	9.9 Sec.	9.9 Sec.	9.9 Sec.	9.9 Sec.	9.9 Sec.	9.9 Sec.	2 Sec.
Stop Bit Select	One	One	One	One	One	One	One	One
ASCII Format	8-Bit	8-Bit	8-Bit	8-Bit	7-Bit	8-Bit	8-Bit	8-Bit
Beep On <BEL>	Disable	Disable	Disable	Disable	Disable	Disable	Disable	Disable
RTS Line State	Low	High	Low	Low = No data to send	Low	High	Low = No data to send	Low
Prefix	None	None	None	None	STX (1003)	None	None	None

***In the Nixdorf Mode B or OPOS/JPOS, if CTS is Low, scanning is disabled. When CTS is High, the user can scan bar codes.**

****If Nixdorf Mode B or OPOS/JPOS is scanned without the scanner connected to the proper host, it may appear unable to scan. If this happens, scan a different RS-232 host type within 5 seconds of cycling power to the scanner.**

RS-232 Host Types

To select an RS-232 host type, scan one of the following bar codes.

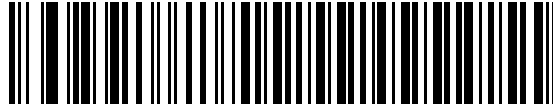

***Standard RS-232**

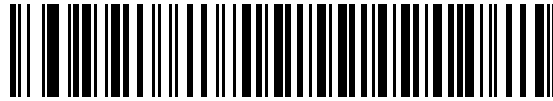

ICL RS-232

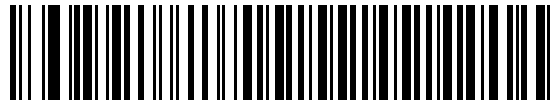

Wincor-Nixdorf RS-232 Mode A



Wincor-Nixdorf RS-232 Mode B

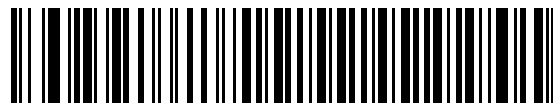

Olivetti ORS4500

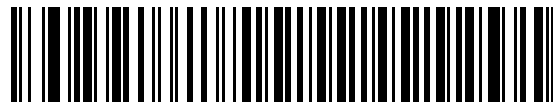

Omron

RS-232 Host Types (continued)

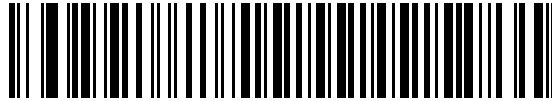

OPOS/JPOS

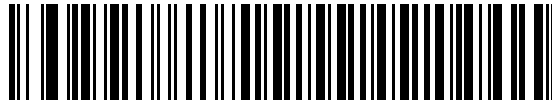

Fujitsu RS-232

Baud Rate

Baud rate is the number of bits of data transmitted per second. Set the scanner's baud rate to match the baud rate setting of the host device. Otherwise, data may not reach the host device or may reach it in distorted form.



Baud Rate 600



Baud Rate 1200



Baud Rate 2400

Baud Rate (continued)



Baud Rate 4800



***Baud Rate 9600**



Baud Rate 19,200

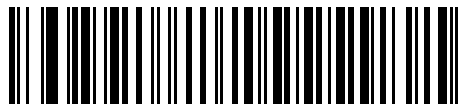

Baud Rate 38,400

Parity

A parity check bit is the most significant bit of each ASCII coded character. Select the parity type according to host device requirements.

Select **Odd** parity to set the parity bit value to 0 or 1, based on data, to ensure that an odd number of 1 bits are contained in the coded character.

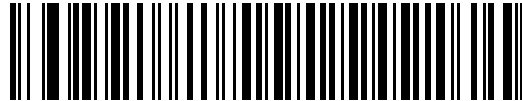

Odd

Select **Even** parity to set the parity bit value to 0 or 1, based on data, to ensure that an even number of 1 bits are contained in the coded character.

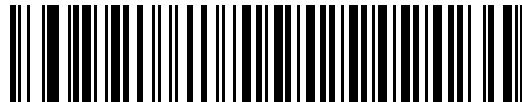

Even

Select **Mark** parity and the parity bit is always 1.

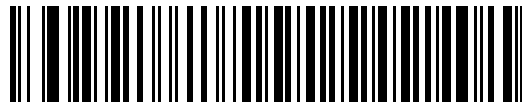

Mark

Parity (continued)

Select **Space** parity and the parity bit is always 0.



Space

Select **None** when no parity bit is required.



***None**

Check Receive Errors

Select whether or not to check the parity, framing, and overrun of received characters. The parity value of received characters is verified against the parity parameter selected above.



***Check For Received Errors (Enable)**



Do Not Check For Received Errors (Disable)

Stop Bit Select

The stop bit(s) at the end of each transmitted character marks the end of transmission of one character and prepares the receiving device for the next character in the serial data stream. The number of stop bits selected (one or two) depends on the number the receiving terminal is programmed to accommodate. Set the number of stop bits to match host device requirements.

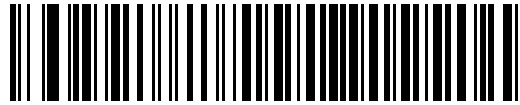

***1 Stop Bit**

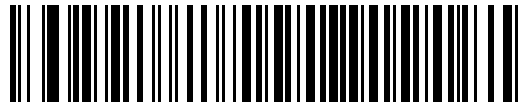

2 Stop Bits

Data Bits

This parameter allows the scanner to interface with devices requiring a 7-bit or 8-bit ASCII protocol.



7-Bit

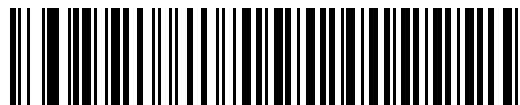

***8-Bit**

Hardware Handshaking

The data interface consists of an RS-232 port designed to operate either with or without the hardware handshaking lines, *Request to Send* (RTS), and *Clear to Send* (CTS).

If Standard RTS/CTS handshaking is not selected, scan data is transmitted as it becomes available. If Standard RTS/CTS handshaking is selected, scan data is transmitted according to the following sequence:

- The scanner reads the CTS line for activity. If CTS is asserted, the scanner waits up to the Host Serial Response Time-out for the host to de-assert the CTS line. If, after Host Serial Response Time-out (default), the CTS line is still asserted, the scanner sounds a transmit error, and any scanned data is lost.
- When the CTS line is de-asserted, the scanner asserts the RTS line and waits up to the Host Serial Response Time-out for the host to assert CTS. When the host asserts CTS, data is transmitted. If, after Host Serial Response Time-out (default), the CTS line is still de-asserted, the scanner sounds a transmit error, and discards the data.
- When data transmission is complete, the scanner de-asserts RTS 10 msec after sending the last character.
- The host should respond by de-asserting CTS. The scanner checks for a de-asserted CTS upon the next transmission of data.

During the transmission of data, the CTS line should be asserted. If CTS is de-asserted for more than 50 ms between characters, the transmission is aborted, the scanner sounds a transmission error, and the data is discarded.

If this communications sequence fails, the scanner issues an error indication. In this case, the data is lost and must be rescanned.

If Hardware Handshaking and Software Handshaking are both enabled, Hardware Handshaking takes precedence.



NOTE The DTR signal is jumpered (set) to the active state.

None

Scan the bar code below if no Hardware Handshaking is desired.

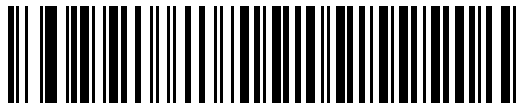

*None

Standard RTS/CTS

Scan the bar code below to select Standard RTS/CTS Hardware Handshaking.



Standard RTS/CTS

Hardware Handshaking (continued)

RTS/CTS Option 1

When RTS/CTS Option 1 is selected, the scanner asserts RTS before transmitting and ignores the state of CTS. The scanner de-asserts RTS when the transmission is complete.

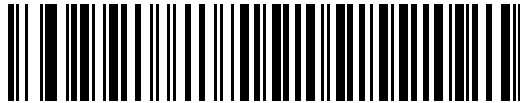

RTS/CTS Option 1

RTS/CTS Option 2

When Option 2 is selected, RTS is always high or low (user-programmed logic level). However, the scanner waits for CTS to be asserted before transmitting data. If CTS is not asserted within Host Serial Response Time-out (default), the scanner issues an error indication and discards the data.

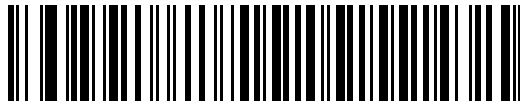

RTS/CTS Option 2

RTS/CTS Option 3

When Option 3 is selected, the scanner asserts RTS prior to any data transmission, regardless of the state of CTS. The scanner waits up to Host Serial Response Time-out (default) for CTS to be asserted. If CTS is not asserted during this time, the scanner issues an error indication and discards the data. The scanner de-asserts RTS when transmission is complete.



RTS/CTS Option 3

Software Handshaking

This parameter offers control of the data transmission process in addition to, or instead of, that offered by hardware handshaking. There are five options.

If Software Handshaking and Hardware Handshaking are both enabled, Hardware Handshaking takes precedence.

None

When this option is selected, data is transmitted immediately. No response is expected from the host.

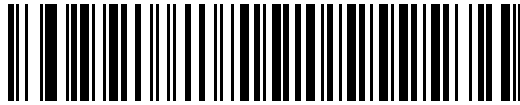

*None

ACK/NAK

When this option is selected, after transmitting data, the scanner expects either an ACK or NAK response from the host. When a NAK is received, the scanner transmits the same data again and waits for either an ACK or NAK. After three unsuccessful attempts to send data when NAKs are received, the scanner issues an error indication and discards the data.

The scanner waits up to the programmable Host Serial Response Time-out to receive an ACK or NAK. If the scanner does not get a response in this time, it issues an error indication and discards the data. There are no retries when a time-out occurs.



ACK/NAK

Software Handshaking (continued)

ENQ

When this option is selected, the scanner waits for an ENQ character from the host before transmitting data. If an ENQ is not received within the Host Serial Response Time-out, the scanner issues an error indication and discards the data. The host must transmit an ENQ character at least every Host Serial Response Time-out to prevent transmission errors.

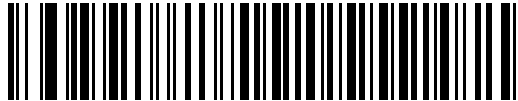

ENQ

ACK/NAK with ENQ

This combines the two previous options. For re-transmissions of data, due to a NAK from the host, an additional ENQ is not required.

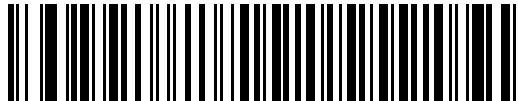

ACK/NAK with ENQ

XON/XOFF

An XOFF character turns the scanner transmission off until the scanner receives an XON character. There are two situations for XON/XOFF:

- XOFF is received before the scanner has data to send. When the scanner has data to send, it waits up to Host Serial Response Time-out for an XON character before transmission. If the XON is not received within this time, the scanner issues an error indication and discards the data.
- XOFF is received during a transmission. Data transmission then stops after sending the current byte. When the scanner receives an XON character, it sends the rest of the data message. The scanner waits up to 30 seconds for the XON.

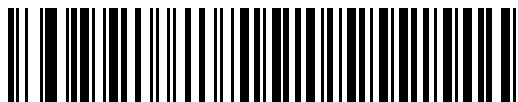

XON/XOFF

Host Serial Response Time-out

This parameter specifies how long the scanner waits for an ACK, NAK, or CTS before determining that a transmission error has occurred. This only applies when in one of the ACK/NAK Software Handshaking modes, or RTS/CTS Hardware Handshaking option.

✓ **NOTE** This parameter does not apply to the Wincor-Nixdorf RS-232 Mode A/B and the OPOS/JPOS host types.



***Minimum: 2 sec**



Low: 2.5 Sec

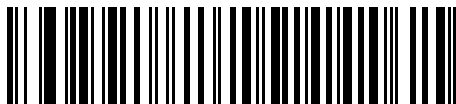

Medium: 5 Sec



High: 7.5 Sec

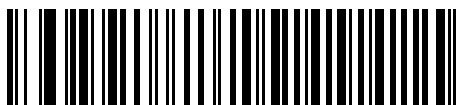

Maximum: 9.9 Sec

RTS Line State

This parameter sets the idle state of the Serial Host RTS line. Scan a bar code below to select **Low RTS** or **High RTS** line state.



*Host: Low RTS



Host: High RTS

Beep on <BEL>

Point-to-Point Mode Only

When this parameter is enabled, the scanner issues a beep when a <BEL> character is detected on the RS-232 serial line. <BEL> is issued to indicate an illegal entry or other important event.

✓ **NOTE** This parameter is not supported in Multipoint-to-Point Mode.



Beep On <BEL> Character
(Enable)



*Do Not Beep On <BEL> Character
(Disable)

Intercharacter Delay

This parameter specifies the intercharacter delay inserted between character transmissions.



***Minimum: 0 msec**



Low: 25 msec



Medium: 50 msec



High: 75 msec



Maximum: 99 msec

Nixdorf Mode A/B and OPOS/JPOS Beep/LED Options

When Nixdorf Mode A, Nixdorf Mode B, or OPOS/JPOS is selected, this parameter indicates when the scanner should beep and turn on its LED after a decode.

✓ **NOTE** The **Beep/LED After CTS Pulse** option is not valid when Nixdorf Mode A is selected.

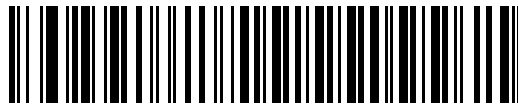

***Normal Operation
(Beep/LED Immediately After Decode)**



Beep/LED After Transmission

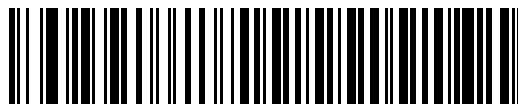

Beep/LED After CTS Pulse

Ignore Unknown Characters

Unknown characters are characters the host does not recognize. When **Send Bar Codes with Unknown Characters** is selected, all bar code data is sent except for unknown characters, and no error beeps sound on the scanner. When **Do Not Send Bar Codes With Unknown Characters** is selected, bar code data is sent up to the first unknown character and then an error beep sounds on the scanner.

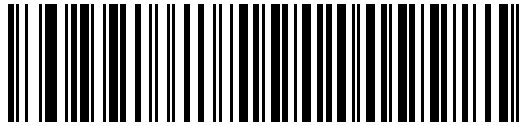

***Send Bar Code with Unknown Characters
(Enable)**

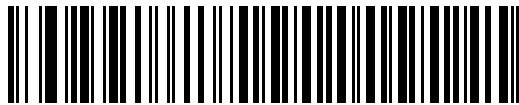

**Do Not Send Bar Codes with Unknown Characters
(Disable)**

ASCII / Character Set

The values in [Table 7-4](#) can be assigned as prefixes or suffixes for ASCII character data transmission.

Table 7-4 RS-232 Prefix/Suffix Values

Prefix/Suffix Value	Full ASCII Code 39 Encode Character	ASCII Character
1000	%U	NUL
1001	\$A	SOH
1002	\$B	STX
1003	\$C	ETX
1004	\$D	EOT
1005	\$E	ENQ
1006	\$F	ACK
1007	\$G	BELL
1008	\$H	BCKSPC
1009	\$I	HORIZ TAB
1010	\$J	LF/NW LN
1011	\$K	VT

Table 7-4 RS-232 Prefix/Suffix Values (Continued)

Prefix/Suffix Value	Full ASCII Code 39 Encode Character	ASCII Character
1012	\$L	FF
1013	\$M	CR/ENTER
1014	\$N	SO
1015	\$O	SI
1016	\$P	DLE
1017	\$Q	DC1/XON
1018	\$R	DC2
1019	\$S	DC3/XOFF
1020	\$T	DC4
1021	\$U	NAK
1022	\$V	SYN
1023	\$W	ETB
1024	\$X	CAN
1025	\$Y	EM
1026	\$Z	SUB
1027	%A	ESC
1028	%B	FS
1029	%C	GS
1030	%D	RS
1031	%E	US
1032	Space	Space
1033	/A	!
1034	/B	"
1035	/C	#
1036	/D	\$
1037	/E	%
1038	/F	&
1039	/G	'
1040	/H	(
1041	/I)

Table 7-4 RS-232 Prefix/Suffix Values (Continued)

Prefix/Suffix Value	Full ASCII Code 39 Encode Character	ASCII Character
1042	/J	*
1043	/K	+
1044	/L	,
1045	-	-
1046	.	.
1047	/O	/
1048	0	0
1049	1	1
1050	2	2
1051	3	3
1052	4	4
1053	5	5
1054	6	6
1057	7	7
1056	8	8
1057	9	9
1058	/Z	:
1059	%F	;
1060	%G	<
1061	%H	=
1062	%I	>
1063	%J	?
1064	%V	@
1065	A	A
1066	B	B
1067	C	C
1068	D	D
1069	E	E
1070	F	F
1071	G	G

Table 7-4 RS-232 Prefix/Suffix Values (Continued)

Prefix/Suffix Value	Full ASCII Code 39 Encode Character	ASCII Character
1072	H	H
1073	I	I
1074	J	J
1075	K	K
1076	L	L
1077	M	M
1078	N	N
1079	O	O
1080	P	P
1081	Q	Q
1082	R	R
1083	S	S
1084	T	T
1085	U	U
1086	V	V
1087	W	W
1088	X	X
1089	Y	Y
1090	Z	Z
1091	%K	[
1092	%L	\
1093	%M]
1094	%N	^
1095	%O	_
1096	%W	`
1097	+A	a
1098	+B	b
1099	+C	c
1100	+D	d
1101	+E	e

Table 7-4 RS-232 Prefix/Suffix Values (Continued)

Prefix/Suffix Value	Full ASCII Code 39 Encode Character	ASCII Character
1102	+F	f
1103	+G	g
1104	+H	h
1105	+I	i
1106	+J	j
1107	+K	k
1108	+L	l
1109	+M	m
1110	+N	n
1111	+O	o
1112	+P	p
1113	+Q	q
1114	+R	r
1115	+S	s
1116	+T	t
1117	+U	u
1118	+V	v
1119	+W	w
1120	+X	x
1121	+Y	y
1122	+Z	z
1123	%P	{
1124	%Q	
1125	%R	}
1126	%S	~
1127		Undefined
7013		ENTER

Chapter 8 USB Interface

Introduction

This chapter provides instructions for programming the scanner to interface with a USB host. The cradle connects directly to a USB host, or a powered USB hub. The USB host can power the cradle and recharge the scanner battery, but this charging method has limitations. See *Using the USB Interface to Supply Power on page 1-6*.

Throughout the programming bar code menus, default values are indicated with asterisks (*).

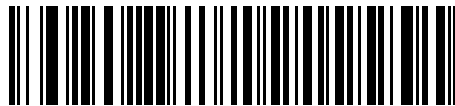

* Indicates Default — ***North American Standard USB Keyboard** — Feature/Option

Connecting a USB Interface

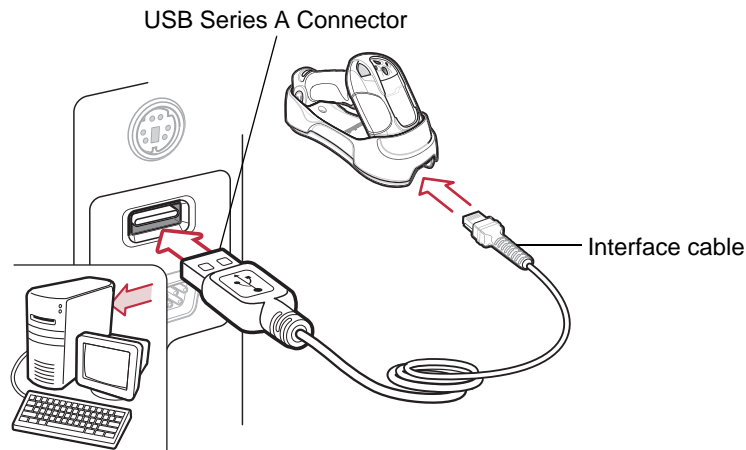

Figure 8-1 USB Connection

The cradle connects with USB-capable hosts including:

- Desktop PCs and notebooks
- Apple™ Macintosh
- IBM SurePOS terminals
- Sun, IBM, and other network computers that support more than one keyboard.

The following operating systems support the scanner through USB:

- Windows® 98, 2000, ME, XP, Vista
- Mac OS 8.5 and above
- IBM 4690 OS.

The cradle also interfaces with other USB hosts which support USB Human Interface Devices (HID).

To connect the cradle to a USB host:

1. Attach the modular connector of the USB interface cable to the cable interface port on the scanner. See *Connecting the Cradle* on page 1-4.
2. Plug the series A connector in the USB host or hub, or plug the Plus Power connector in an available port of the IBM SurePOS terminal.
3. Ensure all connections are secure.
4. Pair the scanner to the cradle by scanning the bar code on the cradle.
5. Select the USB device type by scanning the appropriate bar code from *USB Device Type* on page 8-5.

6. On first installation when using Windows, the software displays a prompt to select or install the *Human Interface Device* driver. To install the Human Interface Device driver provided by Windows, click **Next** through all the choices and click **Finished** on the last choice. The scanner powers up during this installation.
7. To modify any other parameter options, scan the appropriate bar codes in this chapter.
8. Connect an external power supply if desired.

✓ **NOTE** Interface cables vary depending on configuration. The connectors illustrated in [Figure 8-1](#) are examples only. The connectors may be different from those illustrated, but the steps to connect the cradle remain the same.

✓ **NOTE** Disconnect the power supply before changing host cables or the scanner may not recognize the new host.

If problems occur, see *Troubleshooting on page 3-2*.

USB Default Parameters

Table 8-1 lists the defaults for USB host parameters. To change any option, scan the appropriate bar code(s) provided in the parameter descriptions section beginning on [page 8-5](#).

✓ **NOTE** See [Appendix A, Standard Default Parameters](#) for all user preference, host, symbology, and miscellaneous default parameters.

Table 8-1 *USB Host Default Table*

Parameter	Default	Page Number
USB Host Parameters		
USB Device Type	HID Keyboard Emulation	8-5
USB Country Keyboard Types (Country Codes)	North American	8-6
USB Keystroke Delay	No Delay (0 msec)	8-8
USB Caps Lock Override	Disable	8-9
USB Ignore Unknown Characters	Enable	8-9
Emulate Keypad	Disable	8-10
USB Keyboard FN1 Substitution	Disable	8-10
Function Key Mapping	Disable	8-11
Simulated Caps Lock	Disable	8-11
Convert Case	No Case Conversion	8-12

USB Host Parameters

USB Device Type

Select the desired USB device type.



NOTE When changing USB Device Types, the scanner disconnects and reconnects as the cradle re-enumerates on the USB bus.



***HID Keyboard Emulation**

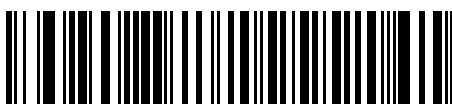

IBM Table Top USB

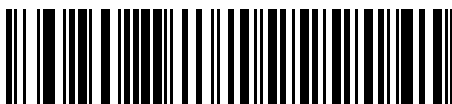

IBM Hand-Held USB



USB OPOS Handheld

USB Country Keyboard Types (Country Codes)

Scan the bar code corresponding to the keyboard type. This setting applies only to the USB HID Keyboard Emulation device.



NOTE When changing USB Country Keyboard Types, the scanner resets and issues the standard startup beep sequences.



***North American Standard USB Keyboard**



German Windows

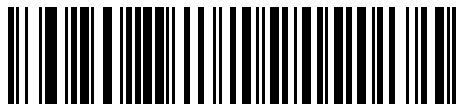

French Windows

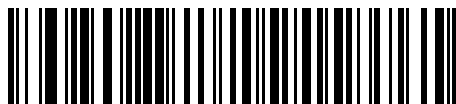

French Canadian Windows 95/98

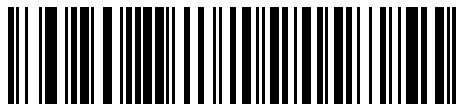
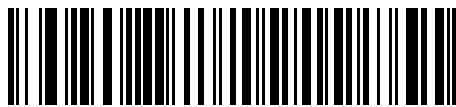
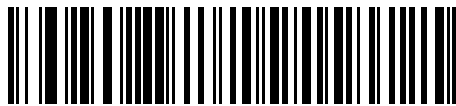
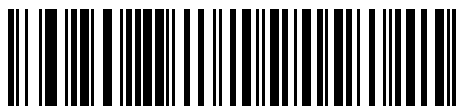
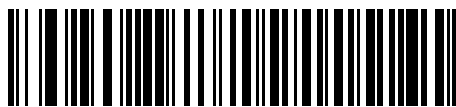
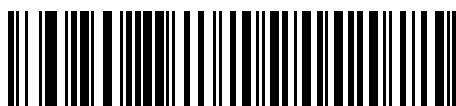

French Canadian Windows 2000/XP

USB Country Keyboard Types (Country Codes) (continued)**French Belgian Windows****Spanish Windows****Italian Windows****Swedish Windows****UK English Windows****Japanese Windows (ASCII)****Brazilian-Portuguese Windows**

USB Keystroke Delay

This parameter sets the delay, in milliseconds, between emulated keystrokes. Scan a bar code below to increase the delay when hosts require slower data transmission.



***No Delay (0 msec)**

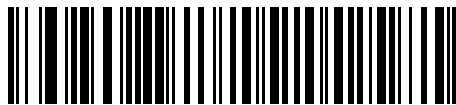

Medium Delay (20 msec)



Long Delay (40 msec)

USB Caps Lock Override

This option applies only to the HID Keyboard Emulation device. When enabled, the case of the data is preserved regardless of the state of the caps lock key. This setting is always enabled for the Japanese, Windows (ASCII) keyboard type and can not be disabled.

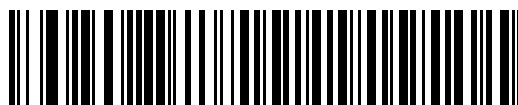

**Override Caps Lock Key
(Enable)**

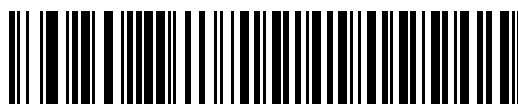

***Do Not Override Caps Lock Key
(Disable)**

USB Ignore Unknown Characters

Unknown characters are characters the host does not recognize. When **Send Bar Codes With Unknown Characters** is selected, all bar code data is sent except for unknown characters, and no error beeps sound. When **Do Not Send Bar Codes With Unknown Characters** is selected, bar codes containing at least one unknown character are not sent to the host, and an error beep sounds.

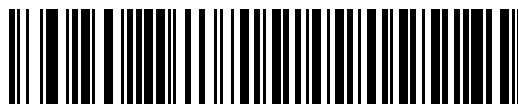

***Send Bar Codes with Unknown Characters
(Enable)**

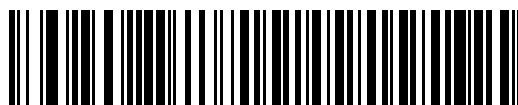

**Do Not Send Bar Codes with Unknown Characters
(Disable)**

Emulate Keypad

When enabled, all characters are sent as ASCII sequences over the numeric keypad. For example ASCII A is sent as “ALT make” 0 6 5 “ALT Break.”



***Disable Keypad Emulation**

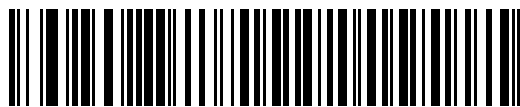

Enable Keypad Emulation

USB Keyboard FN 1 Substitution

This option applies only to the USB HID Keyboard Emulation device. When enabled, this replaces any FN 1 characters in an EAN 128 bar code with a Key Category and a selected value. See *FN1 Substitution Values on page 5-15* to set the Key Category and Key Value.



Enable USB Keyboard FN 1 Substitution

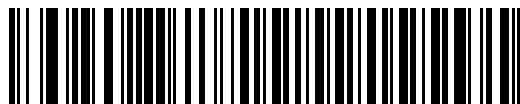

***Disable USB Keyboard FN 1 Substitution**

Function Key Mapping

ASCII values under 32 are normally sent as control-key sequences (see [Table 8-2 on page 8-13](#)). When this parameter is enabled, the keys in bold are sent in place of the standard key mapping. Table entries that do not have a bold entry remain the same regardless of this parameter.

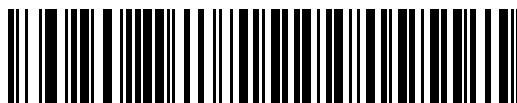

***Disable Function Key Mapping**

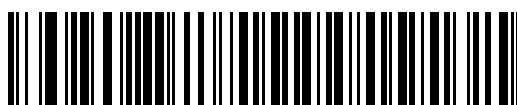

Enable Function Key Mapping

Simulated Caps Lock

When enabled, the scanner inverts upper and lower case characters on the scanner bar code as if the Caps Lock state is enabled on the keyboard. This inversion is done regardless of the keyboard's Caps Lock state.

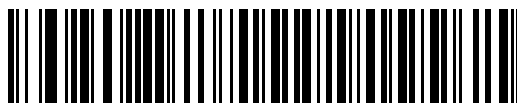

***Disable Simulated Caps Lock**

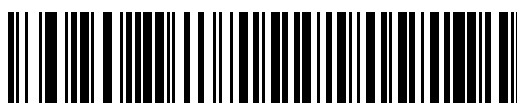

Enable Simulated Caps Lock

Convert Case

When enabled, the scanner converts all bar code data to the selected case.

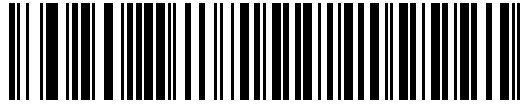

***No Case Conversion**

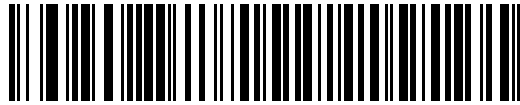

Convert All to Upper Case

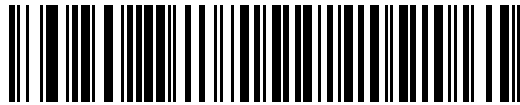

Convert All to Lower Case

ASCII Character Set

Table 8-2 USB Prefix/Suffix Values

Prefix/ Suffix Value	Full ASCII Code 39 Encode Character	Keystroke
1000	%U	CTRL 2
1001	\$A	CTRL A
1002	\$B	CTRL B
1003	\$C	CTRL C
1004	\$D	CTRL D
1005	\$E	CTRL E
1006	\$F	CTRL F
1007	\$G	CTRL G
1008	\$H	CTRL H/ BACKSPACE ¹
1009	\$I	CTRL I / HORIZONTAL TAB ¹
1010	\$J	CTRL J
1011	\$K	CTRL K
1012	\$L	CTRL L
1013	\$M	CTRL M/ ENTER ¹
1014	\$N	CTRL N
1015	\$O	CTRL O
1016	\$P	CTRL P
1017	\$Q	CTRL Q
1018	\$R	CTRL R
1019	\$S	CTRL S
1020	\$T	CTRL T
1021	\$U	CTRL U
1022	\$V	CTRL V
1023	\$W	CTRL W
1024	\$X	CTRL X

¹The keystroke in bold is sent only if the “Function Key Mapping” is enabled. Otherwise, the unbolded keystroke is sent.

Table 8-2 USB Prefix/Suffix Values (Continued)

Prefix/ Suffix Value	Full ASCII Code 39 Encode Character	Keystroke
1025	\$Y	CTRL Y
1026	\$Z	CTRL Z
1027	%A	CTRL [/ ESC ¹
1028	%B	CTRL \
1029	%C	CTRL]
1030	%D	CTRL 6
1031	%E	CTRL -
1032	Space	Space
1033	/A	!
1034	/B	“
1035	/C	#
1036	/D	\$
1037	/E	%
1038	/F	&
1039	/G	‘
1040	/H	(
1041	/I)
1042	/J	*
1043	/K	+
1044	/L	,
1045	-	-
1046	.	.
1047	/O	/
1048	0	0
1049	1	1
1050	2	2
1051	3	3
1052	4	4

¹The keystroke in bold is sent only if the “Function Key Mapping” is enabled. Otherwise, the unbolded keystroke is sent.

Table 8-2 USB Prefix/Suffix Values (Continued)

Prefix/ Suffix Value	Full ASCII Code 39 Encode Character	Keystroke
1053	5	5
1054	6	6
1055	7	7
1056	8	8
1057	9	9
1058	/Z	:
1059	%F	;
1060	%G	<
1061	%H	=
1062	%I	>
1063	%J	?
1064	%V	@
1065	A	A
1066	B	B
1067	C	C
1068	D	D
1069	E	E
1070	F	F
1071	G	G
1072	H	H
1073	I	I
1074	J	J
1075	K	K
1076	L	L
1077	M	M
1078	N	N
1079	O	O
1080	P	P

¹The keystroke in bold is sent only if the “Function Key Mapping” is enabled. Otherwise, the unbolded keystroke is sent.

Table 8-2 USB Prefix/Suffix Values (Continued)

Prefix/ Suffix Value	Full ASCII Code 39 Encode Character	Keystroke
1081	Q	Q
1082	R	R
1083	S	S
1084	T	T
1085	U	U
1086	V	V
1087	W	W
1088	X	X
1089	Y	Y
1090	Z	Z
1091	%K	[
1092	%L	\
1093	%M]
1094	%N	^
1095	%O	_
1096	%W	`
1097	+A	a
1098	+B	b
1099	+C	c
1100	+D	d
1101	+E	e
1102	+F	f
1103	+G	g
1104	+H	h
1105	+I	i
1106	+J	j
1107	+K	k
1108	+L	l

¹The keystroke in bold is sent only if the "Function Key Mapping" is enabled. Otherwise, the unbolded keystroke is sent.

Table 8-2 USB Prefix/Suffix Values (Continued)

Prefix/ Suffix Value	Full ASCII Code 39 Encode Character	Keystroke
1109	+M	m
1110	+N	n
1111	+O	o
1112	+P	p
1113	+Q	q
1114	+R	r
1115	+S	s
1116	+T	t
1117	+U	u
1118	+V	v
1119	+W	w
1120	+X	x
1121	+Y	y
1122	+Z	z
1123	%P	{
1124	%Q	
1125	%R	}
1126	%S	~

¹The keystroke in bold is sent only if the “Function Key Mapping” is enabled. Otherwise, the unbolded keystroke is sent.

Table 8-3 *USB ALT Key Character Set*

ALT Keys	Keystroke
2064	ALT 2
2065	ALT A
2066	ALT B
2067	ALT C
2068	ALT D
2069	ALT E
2070	ALT F
2071	ALT G
2072	ALT H
2073	ALT I
2074	ALT J
2075	ALT K
2076	ALT L
2077	ALT M
2078	ALT N
2079	ALT O
2080	ALT P
2081	ALT Q
2082	ALT R
2083	ALT S
2084	ALT T
2085	ALT U
2086	ALT V
2087	ALT W
2088	ALT X
2089	ALT Y
2090	ALT Z

Table 8-4 USB GUI Key Character Set

GUI Key	Keystroke
3000	Right Control Key
3048	GUI 0
3049	GUI 1
3050	GUI 2
3051	GUI 3
3052	GUI 4
3053	GUI 5
3054	GUI 6
3055	GUI 7
3056	GUI 8
3057	GUI 9
3065	GUI A
3066	GUI B
3067	GUI C
3068	GUI D
3069	GUI E
3070	GUI F
3071	GUI G
3072	GUI H
3073	GUI I
3074	GUI J
3075	GUI K
3076	GUI L
3077	GUI M
3078	GUI N
3079	GUI O
3080	GUI P

Note: GUI Shift Keys - The Apple™ iMac keyboard has an apple key on either side of the space bar. Windows-based systems have a GUI key to the left of the left ALT key, and to the right of the right ALT key.

Table 8-4 USB GUI Key Character Set (Continued)

GUI Key	Keystroke
3081	GUI Q
3082	GUI R
3083	GUI S
3084	GUI T
3085	GUI U
3086	GUI V
3087	GUI W
3088	GUI X
3089	GUI Y
3090	GUI Z

Note: GUI Shift Keys - The Apple™ iMac keyboard has an apple key on either side of the space bar. Windows-based systems have a GUI key to the left of the left ALT key, and to the right of the right ALT key.

Table 8-5 USB F Key Character Set

F Keys	Keystroke
5001	F1
5002	F2
5003	F3
5004	F4
5005	F5
5006	F6
5007	F7
5008	F8
5009	F9
5010	F10
5011	F11
5012	F12
5013	F13
5014	F14
5015	F15

Table 8-5 *USB F Key Character Set (Continued)*

F Keys	Keystroke
5016	F16
5017	F17
5018	F18
5019	F19
5020	F20
5021	F21
5022	F22
5023	F23
5024	F24

Table 8-6 *USB Numeric Keypad Character Set*

Numeric Keypad	Keystroke
6042	*
6043	+
6044	undefined
6045	-
6046	.
6047	/
6048	0
6049	1
6050	2
6051	3
6052	4
6053	5
6054	6
6055	7
6056	8
6057	9
6058	Enter
6059	Num Lock

Table 8-7 *USB Extended Keypad Character Set*

Extended Keypad	Keystroke
7001	Break
7002	Delete
7003	PgUp
7004	End
7005	Pg Dn
7006	Pause
7007	Scroll Lock
7008	Backspace
7009	Tab
7010	Print Screen
7011	Insert
7012	Home
7013	Enter
7014	Escape
7015	Up Arrow
7016	Down Arrow
7017	Left Arrow
7018	Right Arrow

Chapter 9 IBM 468X/469X Interface

Introduction

This chapter provides instructions for programming the scanner to interface with an IBM 468X/469X host computer. Throughout the programming bar code menus, default values are indicated with asterisks (*).

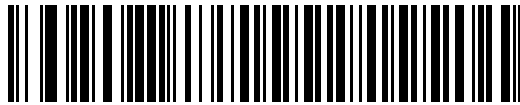

* Indicates Default — ***Disable Convert to** — Feature/Option
Code 39

Connecting to an IBM 468X/469X Host

This connection is made directly from the cradle to the host interface.

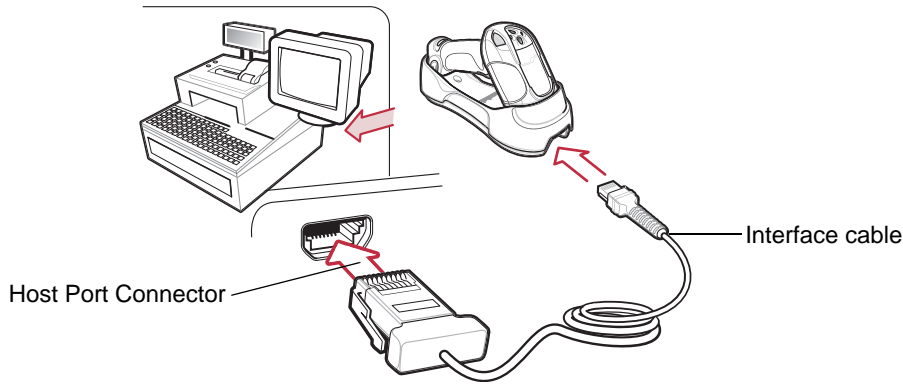

Figure 9-1 IBM Direct Connection

- ✓ **NOTE** Interface cables vary depending on configuration. The connectors illustrated in [Figure 9-1](#) are examples only. The connectors may be different from those illustrated, but the steps to connect the cradle remain the same.

 - ✓ **NOTE** Disconnect the power supply before changing host cables or the scanner may not recognize the new host.
1. Connect the modular connector of the IBM 46XX interface cable to the cable interface port on the cradle. See [Connecting the Cradle on page 1-4](#).
 2. Connect the other end of the IBM 46XX interface cable to the appropriate port on the host (typically Port 9).
 3. Connect an external power supply.
 4. Ensure all connections are secure.
 5. Pair the scanner to the cradle by scanning the bar code on the cradle.
 6. Select the port address by scanning the appropriate bar code from [Port Address on page 9-4](#).
 7. To modify other parameter options, scan the appropriate bar codes in this chapter.
- ✓ **NOTE** The only required configuration is the port address. Most other scanner parameters are typically controlled by the IBM system.

IBM Default Parameters

Table 9-1 lists the defaults for IBM host parameters. To change any option, scan the appropriate bar code(s) provided in the parameter descriptions section beginning on [page 9-4](#).

✓ **NOTE** See [Appendix A, Standard Default Parameters](#) for all user preference, host, symbology, and miscellaneous default parameters.

Table 9-1 *IBM Host Default Table*

Parameter	Default	Page Number
IBM 468X/469X Host Parameters		
Port Address	None Selected	9-4
Convert Unknown to Code 39	Disable	9-4

IBM 468X/469X Host Parameters

Port Address

Use this parameter to set the IBM 468X/469X port.

✓ **NOTE** Scanning one of these bar codes enables the RS-485 interface on the scanner.

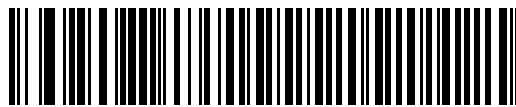

Hand-held Scanner Emulation (Port 9B)



Non-IBM Scanner Emulation (Port 5B)



Table-top Scanner Emulation (Port 17)

Convert Unknown to Code 39

Scan one of the following bar codes to enable or disable the conversion of unknown bar code type data to Code 39.

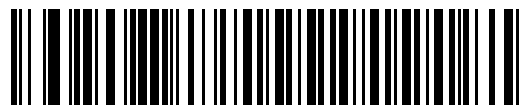

Convert Unknown to Code 39 (Enable)



***Do Not Convert Unknown to Code 39 (Disable)**

Chapter 10 123Scan

Introduction

123Scan is a Windows®-based utility that programs the scanner with all parameters including Advanced Data Formatting (ADF) rules. An ADF rule modifies bar code data before it is sent to the host, ensuring compatibility between bar coded data and the host application without having to modify the host software. Scanners can be programmed via PC download or by scanning a sheet of bar codes generated by 123Scan. Save scanner programming in a file for electronic distribution. 123Scan includes a help file.

Setting Up 123Scan

To communicate with the 123Scan program:

1. Load 123Scan, included in the documentation CD-ROM, onto a host computer running Windows 98, Windows 2000, or Windows XP.
2. Connect the scanner to the host computer using an RS-232 cable. See *Connecting an RS-232 Interface on page 7-2*.
3. Scan the following bar code to enable the 123Scan interface on the scanner. Refer to the 123Scan instructions for programming the scanner.



123Scan Configuration



NOTE Setting defaults unpairs the scanner with the cradle, and you must rescan the pairing bar code.

Chapter 11 Symbologies

Introduction

This chapter describes symbology features and provides the programming bar codes for selecting these features for the scanner. Before programming, follow the instructions in [Chapter 1, Getting Started](#).

The scanner is shipped with the settings shown in the *Symbology Default Table on page 11-2* (also see [Appendix A, Standard Default Parameters](#) for all host device and miscellaneous scanner defaults). If the default values suit requirements, programming is not necessary. Set feature values by scanning single bar codes or short bar code sequences. To return all features to default values, scan the [Default Parameters on page 5-4](#).

If not using a Synapse or USB cable, select the host type (see the specific host chapter) after the scanner emits power-up beeps.

Scanning Sequence Examples

In most cases, scan only one bar code to set a parameter value. For example, to transmit bar code data without the UPC-A check digit, scan the [Do Not Transmit UPC-A Check Digit](#) bar code under *Transmit UPC-A/UPC-E/UPC-E1 Check Digit on page 11-12*. The scanner issues a fast warble beep and the LED turns green, indicating a successful parameter entry.

Other parameters, such as **Set Length(s) for D 2 of 5** require scanning several bar codes in sequence. See the parameter description for this procedure.

Errors While Scanning

Unless otherwise specified, if an error is made during a scanning sequence, re-scan the correct parameter.

Symbology Default Parameters

Table 11-1 lists the defaults for all symbologies parameters. To change any option, scan the appropriate bar code(s) provided in this chapter.



NOTE See [Appendix A, Standard Default Parameters](#) for all user preference, host, symbology, and miscellaneous default parameters.

Table 11-1 *Symbology Default Table*

Parameter	Default	Page Number
UPC/EAN		
UPC-A	Enable	11-5
UPC-E	Enable	11-5
UPC-E1	Disable	11-6
EAN-13/JAN 13	Enable	11-6
EAN-8/JAN 8	Enable	11-7
Bookland EAN	Disable	11-7
Decode UPC/EAN/JAN Supplementals (2 and 5 digits)	Ignore Supplementals	11-8
User-Programmable Supplementals		11-11
UPC/EAN/JAN Supplemental Redundancy	7	11-12
Transmit UPC-A Check Digit	Enable	11-12
Transmit UPC-E Check Digit	Enable	11-12
Transmit UPC-E1 Check Digit	Enable	11-12
UPC-A Preamble	System Character	11-14
UPC-E Preamble	System Character	11-15
UPC-E1 Preamble	System Character	11-16
Convert UPC-E to A	Disable	11-17
Convert UPC-E1 to A	Disable	11-17
EAN-8/JAN-8 Extend	Disable	11-18
Bookland ISBN Format	ISBN-10	11-19
UCC Coupon Extended Code	Disable	11-20

Table 11-1 Symbology Default Table (Continued)

Parameter	Default	Page Number
Code 128		
Code 128	Enable	11-21
UCC/EAN-128	Enable	11-22
ISBT 128	Enable	11-22
Code 39		
Code 39	Enable	11-23
Trioptic Code 39	Disable	11-23
Convert Code 39 to Code 32	Disable	11-24
Code 32 Prefix	Disable	11-24
Set Length(s) for Code 39	2 to 55	11-25
Code 39 Check Digit Verification	Disable	11-26
Transmit Code 39 Check Digit	Disable	11-26
Code 39 Full ASCII Conversion	Disable	11-27
Code 93		
Code 93	Disable	11-28
Set Lengths for Code 93	4 to 55	11-28
Code 11		
Code 11	Disable	11-30
Set Lengths for Code 11	4 to 55	11-31
Code 11 Check Digit Verification	One Check Digit	11-32
Transmit Code 11 Check Digits	Disable	11-33
Interleaved 2 of 5 (I 2 of 5)		
Interleaved 2 of 5 (I 2 of 5)	Enable	11-34
Set Lengths for Interleaved 2 of 5	14	11-34
I 2 of 5 Check Digit Verification	Disable	11-36
Transmit I 2 of 5 Check Digit	Disable	11-36
Convert I 2 of 5 to EAN-13	Disable	11-37
Discrete 2 of 5 (D 2 of 5)		
Discrete 2 of 5	Disable	11-37
Set Lengths for D 2 of 5	12	11-38

Table 11-1 Symbology Default Table (Continued)

Parameter	Default	Page Number
Codabar (NW - 7)		
Codabar	Disable	11-39
Set Lengths for Codabar	5 to 55	11-40
CLSI Editing	Disable	11-41
NOTIS Editing	Disable	11-41
MSI		
MSI	Disable	11-42
Set Lengths for MSI	1 to 55	11-43
MSI Check Digits	One	11-44
Transmit MSI Check Digit(s)	Disable	11-45
MSI Check Digit Algorithm	Mod 10/Mod 10	11-45
GS1 DataBar		
GS1 DataBar-14	Disable	11-46
GS1 DataBar Limited	Disable	11-46
GS1 DataBar Expanded	Disable	11-47
Convert GS1 DataBar to UPC/EAN	Disable	11-47
Symbology - Specific Security Levels		
Redundancy Level	1	11-48
Security Levels	0	11-50
Bi-directional Redundancy	Disable	11-51

UPC/EAN

Enable/Disable UPC-A

To enable or disable UPC-A, scan the appropriate bar code below.

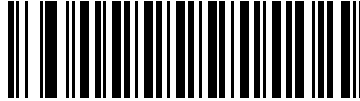

***Enable UPC-A**



Disable UPC-A

Enable/Disable UPC-E

To enable or disable UPC-E, scan the appropriate bar code below.

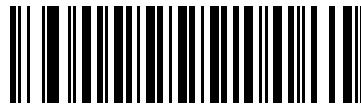

***Enable UPC-E**



Disable UPC-E

Enable/Disable UPC-E1

To enable or disable UPC-E1, scan the appropriate bar code below.

✓ **NOTE** UPC-E1 is not a UCC (Uniform Code Council) approved symbology.



Enable UPC-E1

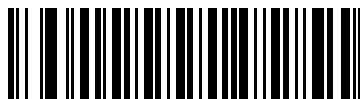

*Disable UPC-E1

Enable/Disable EAN-13

To enable or disable EAN-13, scan the appropriate bar code below.

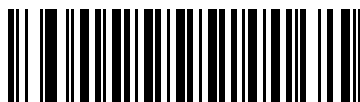

*Enable EAN-13/JAN-13

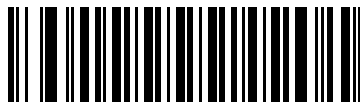

Disable EAN-13/JAN-13

Enable/Disable EAN-8

To enable or disable EAN-8, scan the appropriate bar code below.

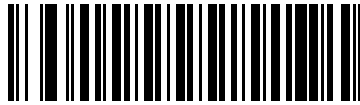

***Enable EAN-8/JAN-8**

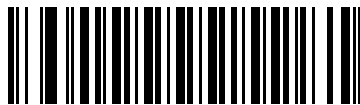

Disable EAN-8/JAN-8

Enable/Disable Bookland EAN

To enable or disable Bookland EAN, scan the appropriate bar code below.



Enable Bookland EAN



***Disable Bookland EAN**

- ✓ **NOTE** If you enable Bookland EAN, select a *Bookland ISBN Format* on page 11-19. Also select either Decode UPC/EAN Supplementals, Autodiscriminate UPC/EAN Supplementals, or Enable 978/979 Supplemental Mode in *Decode UPC/EAN/JAN Supplementals* on page 11-8..

Decode UPC/EAN/JAN Supplementals

Supplementals are bar codes appended according to specific format conventions (e.g., UPC A+2, UPC E+2, EAN 13+2). The following options are available:

- If you select **Ignore UPC/EAN with Supplementals**, and the scanner is presented with a UPC/EAN plus supplemental symbol, the scanner decodes UPC/EAN and ignores the supplemental characters.
- If you select **Decode UPC/EAN with Supplementals**, the scanner only decodes UPC/EAN symbols with supplemental characters, and ignores symbols without supplementals.
- If you select **Autodiscriminate UPC/EAN Supplementals**, the scanner decodes UPC/EAN symbols with supplemental characters immediately. If the symbol does not have a supplemental, the scanner must decode the bar code the number of times set via [UPC/EAN/JAN Supplemental Redundancy](#) on [page 11-12](#) before transmitting its data to confirm that there is no supplemental.
- If you select one of the following **Supplemental Mode** options, the scanner immediately transmits EAN-13 bar codes starting with that prefix that have supplemental characters. If the symbol does not have a supplemental, the scanner must decode the bar code the number of times set via [UPC/EAN/JAN Supplemental Redundancy](#) on [page 11-12](#) before transmitting its data to confirm that there is no supplemental. The scanner transmits UPC/EAN bar codes that do not have that prefix immediately.
 - **Enable 378/379 Supplemental Mode**
 - **Enable 978/979 Supplemental Mode**



NOTE If you select 978/979 Supplemental Mode and are scanning Bookland EAN bar codes, see [Enable/Disable Bookland EAN](#) on [page 11-7](#) to enable Bookland EAN, and select a format using [Bookland ISBN Format](#) on [page 11-19](#).

- **Enable 977 Supplemental Mode**
- **Enable 414/419/434/439 Supplemental Mode**
- **Enable 491 Supplemental Mode**
- **Enable Smart Supplemental Mode** - applies to EAN-13 bar codes starting with any prefix listed previously.
- **Supplemental User-Programmable Type 1** - applies to EAN-13 bar codes starting with a 3-digit user-defined prefix. Set this 3-digit prefix using **Supplemental User-Programmable 1**.
- **Supplemental User-Programmable Type 1 and 2** - applies to EAN-13 bar codes starting with either of two 3-digit user-defined prefixes. Set the 3-digit prefixes using **Supplemental User-Programmable 1** and **Supplemental User-Programmable 2**.
- **Smart Supplemental Plus User-Programmable 1** - applies to EAN-13 bar codes starting with any prefix listed previously or the user-defined prefix set using **Supplemental User-Programmable 1**.
- **Smart Supplemental Plus User-Programmable 1 and 2** - applies to EAN-13 bar codes starting with any prefix listed previously or one of the two user-defined prefixes set using **Supplemental User-Programmable 1** and **Supplemental User-Programmable 2**.
- Select **Supplemental User-Programmable 1** to set a 3-digit prefix. Then select the 3 digits using the numeric bar codes beginning on [page D-1](#).
- Select **Supplemental User-Programmable 2** to set a second 3-digit prefix. Then select the 3 digits using the numeric bar codes beginning on [page D-1](#).



NOTE To minimize the risk of invalid data transmission, select either to decode or ignore supplemental characters.

Decode UPC/EAN/JAN Supplementals (continued)



***Ignore UPC/EAN/JAN With Supplementals**



Decode UPC/EAN/JAN Only With Supplementals



Autodiscriminate UPC/EAN/JAN Supplementals



Enable 378/379 Supplemental Mode



Enable 978/979 Supplemental Mode



Enable 977 Supplemental Mode

Decode UPC/EAN/JAN Supplementals (continued)



Enable 414/419/434/439 Supplemental Mode



Enable 491 Supplemental Mode



Enable Smart Supplemental Mode



Supplemental User-Programmable Type 1



Supplemental User-Programmable Type 1 and 2

Decode UPC/EAN/JAN Supplementals (continued)



Smart Supplemental Plus User-Programmable 1



Smart Supplemental Plus User-Programmable 1 and 2

User-Programmable Supplementals

If you selected a Supplemental User-Programmable option from *Decode UPC/EAN/JAN Supplementals on page 11-8*, select **User-Programmable Supplemental 1** to set the 3-digit prefix. Then select the 3 digits using the numeric bar codes beginning on [page D-1](#). Select **User-Programmable Supplemental 2** to set a second 3-digit prefix. Then select the 3 digits using the numeric bar codes beginning on [page D-1](#)



Supplemental User-Programmable 1



Supplemental User-Programmable 2

UPC/EAN/JAN Supplemental Redundancy

With **Autodiscriminate UPC/EAN/JAN Supplementals** selected, this option adjusts the number of times a symbol without supplementals is decoded before transmission. The range is from two to 30 times. 14 or above is recommended when decoding a mix of UPC/EAN symbols with and without supplementals, and the autodiscriminate option is selected. The default is set at 7.

Scan the following bar code to set a decode redundancy value. Next, scan two numeric bar codes from [Appendix D, Numeric Bar Codes](#). Use a leading zero for single digit numbers. In case of an error, or to change the selection, scan **Cancel** on [page D-3](#).

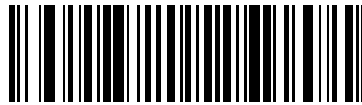

UPC/EAN/JAN Supplemental Redundancy

Transmit UPC-A/UPC-E/UPC-E1 Check Digit

The check digit is the last character of the symbol used to verify the integrity of the data. Scan the appropriate bar code to transmit the bar code data with or without the UPC-A, UPC-E or UPC-E1 check digit. It is always verified to guarantee the integrity of the data.

UPC-A Check Digit

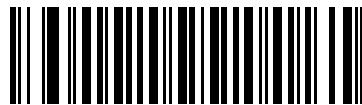

*Transmit UPC-A Check Digit

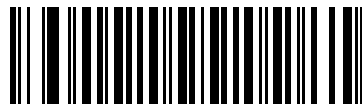

Do Not Transmit UPC-A Check Digit

UPC-E Check Digit

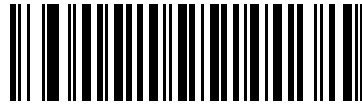

***Transmit UPC-E Check Digit**

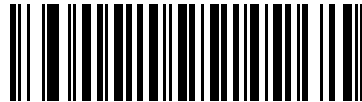

Do Not Transmit UPC-E Check Digit

UPC-E1 Check Digit

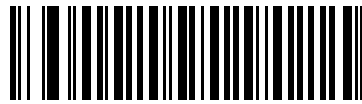

***Transmit UPC-E1 Check Digit**



Do Not Transmit UPC-E1 Check Digit

UPC-A Preamble

Preamble characters are part of the UPC symbol consisting of Country Code and System Character. There are three options for transmitting UPC-A preamble to the host device:

- Transmit System Character only.
- Transmit System Character and Country Code ("0" for USA).
- No preamble transmitted.

Select the appropriate option to match the host system.

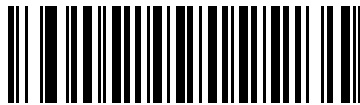

No Preamble
(<DATA>)

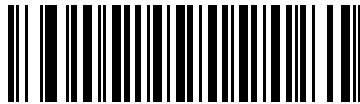

***System Character**
(<SYSTEM CHARACTER> <DATA>)

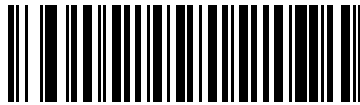

System Character & Country Code
(< COUNTRY CODE> <SYSTEM CHARACTER> <DATA>)

UPC-E Preamble

Preamble characters are part of the UPC symbol consisting of Country Code and System Character. There are three options for transmitting UPC-E preamble to the host device:

- Transmit System Character only.
- Transmit System Character and Country Code ("0" for USA).
- No preamble transmitted.

Select the appropriate option to match the host system.



No Preamble
(<DATA>)

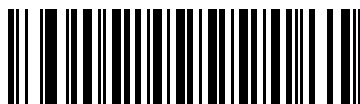

***System Character**
(<SYSTEM CHARACTER> <DATA>)

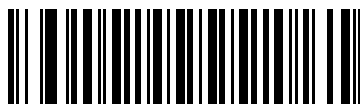

System Character & Country Code
(< COUNTRY CODE> <SYSTEM CHARACTER> <DATA>)

UPC-E1 Preamble

Preamble characters are part of the UPC symbol consisting of Country Code and System Character. There are three options for transmitting UPC-E1 preamble to the host device:

- Transmit System Character only.
- Transmit System Character and Country Code ("0" for USA).
- No preamble transmitted.

Select the appropriate option to match the host system.

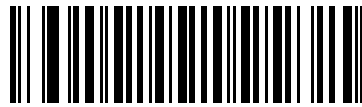

No Preamble
(<DATA>)

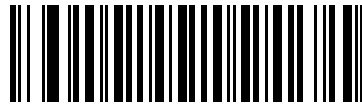

***System Character**
(<SYSTEM CHARACTER> <DATA>)

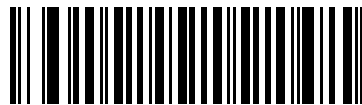

System Character & Country Code
(< COUNTRY CODE> <SYSTEM CHARACTER> <DATA>)

Convert UPC-E to UPC-A

When enabled, UPC-E (zero suppressed) decoded data is converted to UPC-A format before transmission. After conversion, the data follows UPC-A format and is affected by UPC-A programming selections (e.g., Preamble, Check Digit).

When disabled, UPC-E decoded data is transmitted as UPC-E data, without conversion.

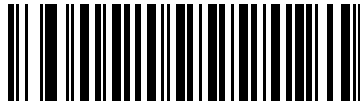

**Convert UPC-E to UPC-A
(Enable)**

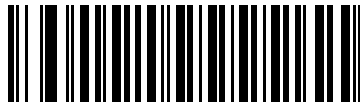

***Do Not Convert UPC-E to UPC-A
(Disable)**

Convert UPC-E1 to UPC-A

When enabled, UPC-E1 decoded data is converted to UPC-A format before transmission. After conversion, the data follows UPC-A format and is affected by UPC-A programming selections (e.g., Preamble, Check Digit).

When disabled, UPC-E1 decoded data is transmitted as UPC-E1 data, without conversion.

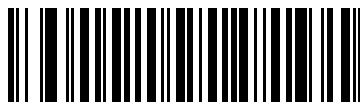

**Convert UPC-E1 to UPC-A
(Enable)**



***Do Not Convert UPC-E1 to UPC-A
(Disable)**

EAN-8/JAN-8 Extend

When enabled, this parameter adds five leading zeros to decoded EAN-8 symbols to make them compatible in format to EAN-13 symbols.

When disabled, EAN-8 symbols are transmitted as is.

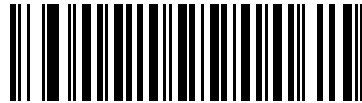

Enable EAN/JAN Zero Extend



***Disable EAN/JAN Zero Extend**

Bookland ISBN Format

If you enabled Bookland EAN using *Enable/Disable Bookland EAN on page 11-7*, select one of the following formats for Bookland data:

- **Bookland ISBN-10** - The scanner reports Bookland data starting with 978 in traditional 10-digit format with the special Bookland check digit for backward-compatibility. Data starting with 979 is not considered Bookland in this mode.
- **Bookland ISBN-13** - The scanner reports Bookland data (starting with either 978 or 979) as EAN-13 in 13-digit format to meet the 2007 ISBN-13 protocol.



***Bookland ISBN-10**



Bookland ISBN-13



NOTE For Bookland EAN to function properly, first enable Bookland EAN using *Enable/Disable Bookland EAN on page 11-7*, then select either Decode UPC/EAN Supplementals, Autodiscriminate UPC/EAN Supplementals, or Enable 978/979 Supplemental Mode in *Decode UPC/EAN/JAN Supplementals on page 11-8*.

UCC Coupon Extended Code

When enabled, this parameter decodes UPC-A bar codes starting with digit '5', EAN-13 bar codes starting with digit '99', and UPC-A/EAN-128 Coupon Codes. UPCA, EAN-13, and EAN-128 must be enabled to scan all types of Coupon Codes.

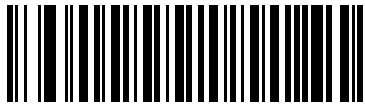

Enable UCC Coupon Extended Code



***Disable UCC Coupon Extended Code**

- ✓ **NOTE** Use the Decode UPC/EAN Supplemental Redundancy parameter to control autodiscrimination of the EAN128 (right half) of a coupon code.

Code 128

Enable/Disable Code 128

To enable or disable Code 128, scan the appropriate bar code below.

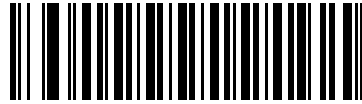

***Enable Code 128**

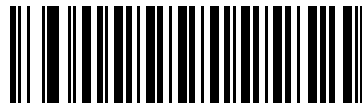

Disable Code 128

Enable/Disable UCC/EAN-128

To enable or disable UCC/EAN-128, scan the appropriate bar code below.

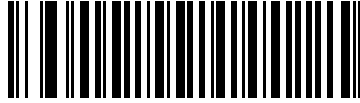

***Enable UCC/EAN-128**

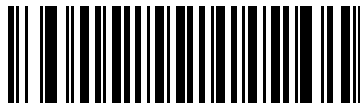

Disable UCC/EAN-128

Enable/Disable ISBT 128

To enable or disable ISBT 128, scan the appropriate bar code below.

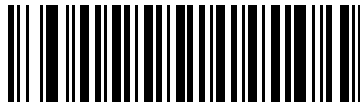

***Enable ISBT 128**



Disable ISBT 128

Code 39

Enable/Disable Code 39

To enable or disable Code 39, scan the appropriate bar code below.

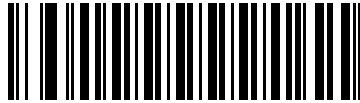

***Enable Code 39**

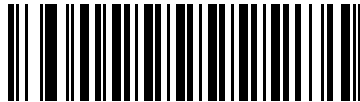

Disable Code 39

Enable/Disable Trioptic Code 39

Trioptic Code 39 is a variant of Code 39 used in the marking of computer tape cartridges. Trioptic Code 39 symbols always contain six characters. To enable or disable Trioptic Code 39, scan the appropriate bar code below.

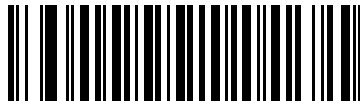

Enable Trioptic Code 39



***Disable Trioptic Code 39**



NOTE Trioptic Code 39 and Code 39 Full ASCII cannot be enabled simultaneously.

Convert Code 39 to Code 32

Code 32 is a variant of Code 39 used by the Italian pharmaceutical industry. Scan the appropriate bar code below to enable or disable converting Code 39 to Code 32.

✓ **NOTE** Code 39 must be enabled for this parameter to function.

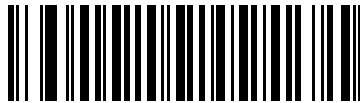

**Convert Code 39 to Code 32
(Enable)**

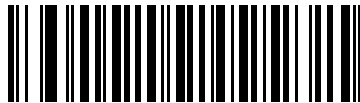

***Do Not Convert Code 39 to Code 32
(Disable)**

Code 32 Prefix

Scan the appropriate bar code to enable or disable adding the prefix character “A” to all Code 32 bar codes.

✓ **NOTE** Convert Code 39 to Code 32 must be enabled for this parameter to function.



Enable Code 32 Prefix



***Disable Code 32 Prefix**

Set Lengths for Code 39

The length of a code refers to the number of characters (i.e., human readable characters), including check digit(s) the code contains. Lengths for Code 39 may be set for any length, one or two discrete lengths, or lengths within a specific range. If Code 39 Full ASCII is enabled, **Length Within a Range** or **Any Length** are the preferred options.

✓ **NOTE** When setting lengths for different bar code types by scanning single digit numbers, the single digit number must always be preceded by a leading zero.

One Discrete Length - This option allows the scanner to decode only those Code 39 symbols containing a selected length. Lengths are selected from the numeric bar codes in [Appendix D, Numeric Bar Codes](#). For example, to decode only Code 39 symbols with 14 characters, scan **Code 39 - One Discrete Length**, then scan **1** followed by **4**. In case of an error, or to change the selection, scan **Cancel** on [page D-3](#).



Code 39 - One Discrete Length

Two Discrete Lengths - This option allows the scanner to decode only those Code 39 symbols containing either of two selected lengths. Lengths are selected from the numeric bar codes in [Appendix D, Numeric Bar Codes](#). For example, to decode only those Code 39 symbols containing either 2 or 14 characters, select **Code 39 - Two Discrete Lengths**, then scan **0, 2, 1**, and then **4**. In case of an error, or to change the selection, scan **Cancel** on [page D-3](#).



Code 39 - Two Discrete Lengths

Length Within Range - This option allows the scanner to decode a Code 39 symbol with a specific length range. The length range is selected from numeric bar codes in [Appendix D, Numeric Bar Codes](#). For example, to decode Code 39 symbols containing between 4 and 12 characters, first scan **Code 39 - Length Within Range**. Then scan **0, 4, 1**, and **2** (insert a leading zero for single digit numbers). In case of an error, or to change the selection, scan **Cancel** on [page D-3](#).



Code 39 - Length Within Range

Any Length - This option allows the scanner to decode Code 39 symbols containing any number of characters within the scanner capability.



Code 39 - Any Length

Code 39 Check Digit Verification

When this feature is enabled, the scanner checks the integrity of all Code 39 symbols to verify that the data complies with a specified check digit algorithm. Only those Code 39 symbols that include a modulo 43 check digit are decoded when this feature is enabled. This feature should only be enabled if the Code 39 symbols contain a Modulo 43 check digit.

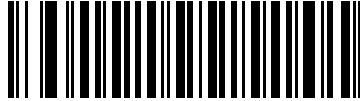

Enable Code 39 Check Digit

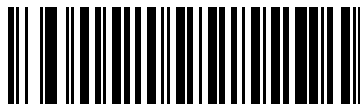

***Disable Code 39 Check Digit**

Transmit Code 39 Check Digit

Scan a bar code below to transmit Code 39 data with or without the check digit.

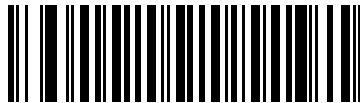

**Transmit Code 39 Check Digit
(Enable)**



***Do Not Transmit Code 39 Check Digit
(Disable)**



NOTE Code 39 Check Digit Verification must be enabled for this parameter to function.

Code 39 Full ASCII Conversion

Code 39 Full ASCII is a variant of Code 39 that pairs characters to encode the full ASCII character set. To enable or disable Code 39 Full ASCII, scan the appropriate bar code below.

See [Table 6-2 on page 6-14](#) and for the mapping of Code 39 characters to ASCII values.

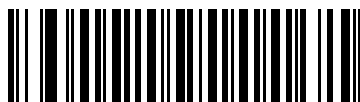

Enable Code 39 Full ASCII



***Disable Code 39 Full ASCII**

- ✓ **NOTE** Trioptic Code 39 and Code 39 Full ASCII cannot be enabled simultaneously.

- ✓ **NOTE** Code 39 Full ASCII to Full ASCII Correlation is host-dependent, and is described in the ASCII Character Set table for the appropriate interface. For keyboard wedge host conversion, see [Table 6-2 on page 6-14](#). For RS-232 host conversion, see [Table 7-4 on page 7-20](#). For USB host conversion, see [Table 8-2 on page 8-13](#).

Code 93

Enable/Disable Code 93

To enable or disable Code 93, scan the appropriate bar code below.

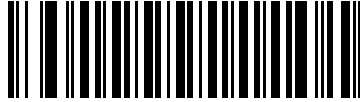

Enable Code 93

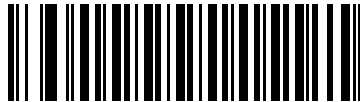

***Disable Code 93**

Set Lengths for Code 93

The length of a code refers to the number of characters (i.e., human readable characters), including check digit(s) the code contains. Lengths for Code 93 may be set for any length, one or two discrete lengths, or lengths within a specific range.

One Discrete Length - This option allows the scanner to decode only those Code 93 symbols containing a selected length. Lengths are selected from the numeric bar codes in [Appendix D, Numeric Bar Codes](#). For example, to decode only Code 93 symbols with 14 characters, scan **Code 93 - One Discrete Length**, then scan **1** followed by **4**. In case of an error, or to change the selection, scan **Cancel** on [page D-3](#).



Code 93 - One Discrete Length

Set Lengths for Code 93 (continued)

Two Discrete Lengths - This option allows the scanner to decode only those Code 93 symbols containing either of two selected lengths. Lengths are selected from the numeric bar codes in [Appendix D, Numeric Bar Codes](#). For example, to decode only those Code 93 symbols containing either 2 or 14 characters, select **Code 93 - Two Discrete Lengths**, then scan **0, 2, 1**, and then **4**. In case of an error, or to change the selection, scan **Cancel** on [page D-3](#).



Code 93 - Two Discrete Lengths

Length Within Range - This option allows the scanner to decode a Code 93 symbol with a specific length range. The length range is selected from numeric bar codes in [Appendix D, Numeric Bar Codes](#). For example, to decode Code 93 symbols containing between 4 and 12 characters, first scan **Code 93 - Length Within Range**. Then scan **0, 4, 1**, and **2** (insert a leading zero for single digit numbers). In case of an error, or to change the selection, scan **Cancel** on [page D-3](#).



Code 93 - Length Within Range

Any Length - This option allows the scanner to decode Code 93 symbols containing any number of characters within the scanner's capability.



Code 93 - Any Length

Code 11

Code 11

To enable or disable Code 11, scan the appropriate bar code below.

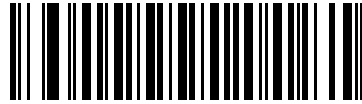

Enable Code 11

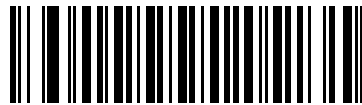

***Disable Code 11**

Set Lengths for Code 11

The length of a code refers to the number of characters (i.e., human readable characters), including check digit(s) the code contains. Lengths for Code 11 may be set for any length, one or two discrete lengths, or lengths within a specific range.

One Discrete Length - This option allows the scanner to decode only those Code 11 symbols containing a selected length. Lengths are selected from the numeric bar codes in [Appendix D, Numeric Bar Codes](#). For example, to decode only Code 11 symbols with 14 characters, scan **Code 11 - One Discrete Length**, then scan **1** followed by **4**. In case of an error, or to change the selection, scan **Cancel** on [page D-3](#).



Code 11 - One Discrete Length

Two Discrete Lengths - This option allows the scanner to decode only those Code 11 symbols containing either of two selected lengths. Lengths are selected from the numeric bar codes in [Appendix D, Numeric Bar Codes](#). For example, to decode only those Code 11 symbols containing either 2 or 14 characters, select **Code 11 - Two Discrete Lengths**, then scan **0, 2, 1**, and then **4**. In case of an error, or to change the selection, scan **Cancel** on [page D-3](#).



Code 11 - Two Discrete Lengths

Length Within Range - This option allows the scanner to decode a Code 11 symbol with a specific length range. The length range is selected from numeric bar codes in [Appendix D, Numeric Bar Codes](#). For example, to decode Code 11 symbols containing between 4 and 12 characters, first scan **Code 11 - Length Within Range**. Then scan **0, 4, 1**, and **2** (insert a leading zero for single digit numbers). In case of an error, or to change the selection, scan **Cancel** on [page D-3](#).



Code 11 - Length Within Range

Any Length - This option allows the scanner to decode Code 11 symbols containing any number of characters within the scanner capability.



Code 11 - Any Length

Code 11 Check Digit Verification

This feature allows the scanner to check the integrity of all Code 11 symbols to verify that the data complies with the specified check digit algorithm. This selects the check digit mechanism for the decoded Code 11 bar code. The options are to check for one check digit, check for two check digits, or disable the feature.

To enable this feature, scan the bar code below corresponding to the number of check digits encoded in the Code 11 symbols.

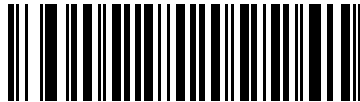

Disable

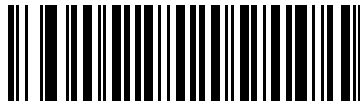

*** One Check Digit**



Two Check Digits

Transmit Code 11 Check Digits

This feature selects whether or not to transmit the Code 11 check digit(s).

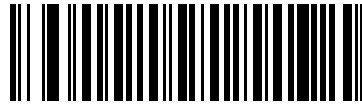

**Transmit Code 11 Check Digit(s)
(Enable)**

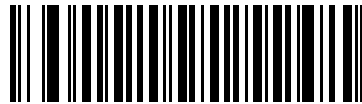

***Do Not Transmit Code 11 Check Digit(s)
(Disable)**



NOTE Code 11 Check Digit Verification must be enabled for this parameter to function.

Interleaved 2 of 5 (I 2 of 5)

Enable/Disable Interleaved 2 of 5

To enable or disable Interleaved 2 of 5, scan the appropriate bar code below, and select an Interleaved 2 of 5 length from the following pages.

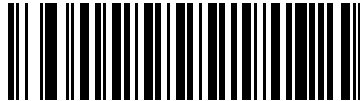

*Enable Interleaved 2 of 5

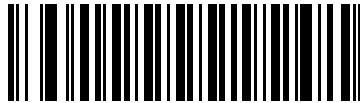

Disable Interleaved 2 of 5

Set Lengths for Interleaved 2 of 5

The length of a code refers to the number of characters (i.e., human readable characters), including check digit(s) the code contains. Lengths for I 2 of 5 may be set for any length, one or two discrete lengths, or lengths within a specific range.

One Discrete Length - This option allows the scanner to decode only those I 2 of 5 symbols containing a selected length. Lengths are selected from the numeric bar codes in [Appendix D, Numeric Bar Codes](#). For example, to decode only I 2 of 5 symbols with 14 characters, scan **I 2 of 5 - One Discrete Length**, then scan **1** followed by **4**. In case of an error, or to change the selection, scan **Cancel** on [page D-3](#).



I 2 of 5 - One Discrete Length

Two Discrete Lengths - This option allows the scanner to decode only those I 2 of 5 symbols containing either of two selected lengths. Lengths are selected from the numeric bar codes in [Appendix D, Numeric Bar Codes](#). For example, to decode only those I 2 of 5 symbols containing either 2 or 14 characters, select **I 2 of 5 - Two Discrete Lengths**, then scan **0, 2, 1**, and then **4**. In case of an error, or to change the selection, scan **Cancel** on [page D-3](#).



I 2 of 5 - Two Discrete Lengths

Set Lengths for Interleaved 2 of 5 (continued)

Length Within Range - This option allows the scanner to decode an I 2 of 5 symbol with a specific length range. The length range is selected from numeric bar codes in [Appendix D, Numeric Bar Codes](#). For example, to decode I 2 of 5 symbols containing between 4 and 12 characters, first scan **I 2 of 5 - Length Within Range**. Then scan **0, 4, 1, and 2** (insert a leading zero for single digit numbers). In case of an error, or to change the selection, scan **Cancel** on [page D-3](#).



I 2 of 5 - Length Within Range

Any Length - This option allows the scanner to decode I 2 of 5 symbols containing any number of characters within the scanner capability.

- ✓ **NOTE** Due to the construction of the I 2 of 5 symbology, it is possible for a scan line covering only a portion of the code to be interpreted as a complete scan, yielding less data than is actually encoded in the bar code. To prevent this from happening, select specific lengths (**I 2 of 5 - One Discrete Length - Two Discrete Lengths**) for I 2 of 5 applications.



I 2 of 5 - Any Length

I 2 of 5 Check Digit Verification

When this feature is enabled, the scanner checks the integrity of all I 2 of 5 symbols to verify that the data complies with either the specified Uniform Symbology Specification (USS), or the Optical Product Code Council (OPCC) check digit algorithm.



***Disable**



USS Check Digit



OPCC Check Digit

Transmit I 2 of 5 Check Digit

Scan the appropriate bar code below to transmit I 2 of 5 data with or without the check digit.



**Transmit I 2 of 5 Check Digit
(Enable)**



***Do Not Transmit I 2 of 5 Check Digit
(Disable)**

Convert I 2 of 5 to EAN-13

This parameter converts a 14 character I 2 of 5 code into EAN-13, and transmits to the host as EAN-13. In order to accomplish this, the I 2 of 5 code must be enabled, and the code must have a leading zero and a valid EAN-13 check digit.

Scanning a single bar code below, **Convert I 2 of 5 to EAN-13 (Enable)**, accomplishes this function.

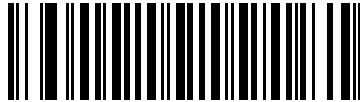

**Convert I 2 of 5 to EAN-13
(Enable)**

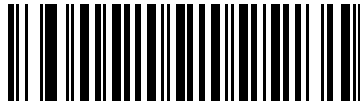

***Do Not Convert I 2 of 5 to EAN-13
(Disable)**

Discrete 2 of 5 (D 2 of 5)

Enable/Disable Discrete 2 of 5

To enable or disable Discrete 2 of 5, scan the appropriate bar code below.

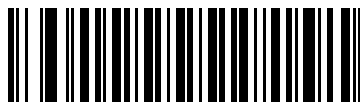

Enable Discrete 2 of 5



***Disable Discrete 2 of 5**

Set Lengths for Discrete 2 of 5

The length of a code refers to the number of characters (i.e., human readable characters), including check digit(s) the code contains. Lengths for D 2 of 5 may be set for any length, one or two discrete lengths, or lengths within a specific range.

One Discrete Length - This option allows the scanner to decode only those D 2 of 5 symbols containing a selected length. Lengths are selected from the numeric bar codes in [Appendix D, Numeric Bar Codes](#). For example, to decode only D 2 of 5 symbols with 14 characters, scan **D 2 of 5 - One Discrete Length**, then scan **1** followed by **4**. In case of an error, or to change the selection, scan **Cancel** on [page D-3](#).



D 2 of 5 - One Discrete Length

Two Discrete Lengths - This option allows the scanner to decode only those D 2 of 5 symbols containing either of two selected lengths. Lengths are selected from the numeric bar codes in [Appendix D, Numeric Bar Codes](#). For example, to decode only those D 2 of 5 symbols containing either 2 or 14 characters, select **D 2 of 5 - Two Discrete Lengths**, then scan **0, 2, 1**, and then **4**. In case of an error, or to change the selection, scan **Cancel** on [page D-3](#).



D 2 of 5 - Two Discrete Lengths

Length Within Range - This option allows the scanner to decode a D 2 of 5 symbol with a specific length range. The length range is selected from numeric bar codes in [Appendix D, Numeric Bar Codes](#). For example, to decode D 2 of 5 symbols containing between 4 and 12 characters, first scan **D 2 of 5 - Length Within Range**. Then scan **0, 4, 1**, and **2** (insert a leading zero for single digit numbers). In case of an error, or to change the selection, scan **Cancel** on [page D-3](#).



D 2 of 5 - Length Within Range

Any Length - This option allows the scanner to decode D 2 of 5 symbols containing any number of characters within the scanner capability.

- ✓ **NOTE** Due to the construction of the D 2 of 5 symbology, it is possible for a scan line covering only a portion of the code to be interpreted as a complete scan, yielding less data than is actually encoded in the bar code. To prevent this from happening, select specific lengths (**D 2 of 5 - One Discrete Length - Two Discrete Lengths**) for D 2 of 5 applications.



D 2 of 5 - Any Length

Codabar (NW - 7)

Enable/Disable Codabar

To enable or disable Codabar, scan the appropriate bar code below.

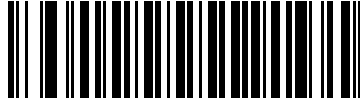

Enable Codabar

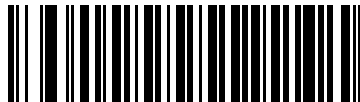

*Disable Codabar

Set Lengths for Codabar

The length of a code refers to the number of characters (i.e., human readable characters), including check digit(s) the code contains. Lengths for Codabar may be set for any length, one or two discrete lengths, or lengths within a specific range.

One Discrete Length - This option allows the scanner to decode only those Codabar symbols containing a selected length. Lengths are selected from the numeric bar codes in [Appendix D, Numeric Bar Codes](#). For example, to decode only Codabar symbols with 14 characters, scan **Codabar - One Discrete Length**, then scan **1** followed by **4**. In case of an error, or to change the selection, scan **Cancel** on [page D-3](#).



Codabar - One Discrete Length

Two Discrete Lengths - This option allows the scanner to decode only those Codabar symbols containing either of two selected lengths. Lengths are selected from the numeric bar codes in [Appendix D, Numeric Bar Codes](#). For example, to decode only those Codabar symbols containing either 2 or 14 characters, select **Codabar - Two Discrete Lengths**, then scan **0, 2, 1**, and then **4**. In case of an error, or to change the selection, scan **Cancel** on [page D-3](#).



Codabar - Two Discrete Lengths

Length Within Range - This option allows the scanner to decode a Codabar symbol with a specific length range. The length range is selected from numeric bar codes in [Appendix D, Numeric Bar Codes](#). For example, to decode Codabar symbols containing between 4 and 12 characters, first scan **Codabar - Length Within Range**. Then scan **0, 4, 1**, and **2** (insert a leading zero for single digit numbers). In case of an error, or to change the selection, scan **Cancel** on [page D-3](#).



Codabar - Length Within Range

Any Length - This option allows the scanner to decode Codabar symbols containing any number of characters within the scanner capability.



Codabar - Any Length

CLSI Editing

When enabled, this parameter strips the start and stop characters and inserts a space after the first, fifth, and tenth characters of a 14-character Codabar symbol. Enable this feature if the host system requires this data format.

✓ **NOTE** Symbol length does not include start and stop characters.

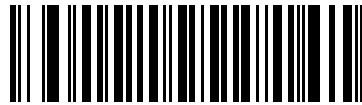

Enable CLSI Editing

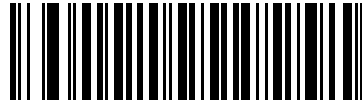

*Disable CLSI Editing

NOTIS Editing

When enabled, this parameter strips the start and stop characters from a decoded Codabar symbol. Enable this feature if the host system requires this data format.

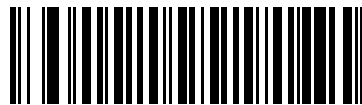

Enable NOTIS Editing

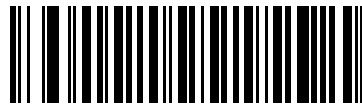

*Disable NOTIS Editing

MSI

Enable/Disable MSI

To enable or disable MSI, scan the appropriate bar code below.

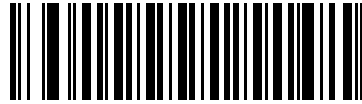

Enable MSI

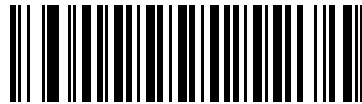

***Disable MSI**

Set Lengths for MSI

The length of a code refers to the number of characters (i.e., human readable characters), including check digit(s) the code contains. Lengths for MSI may be set for any length, one or two discrete lengths, or lengths within a specific range.

One Discrete Length - This option allows the scanner to decode only those MSI symbols containing a selected length. Lengths are selected from the numeric bar codes in [Appendix D, Numeric Bar Codes](#). For example, to decode only MSI symbols with 14 characters, scan **MSI - One Discrete Length**, then scan **1** followed by **4**. In case of an error, or to change the selection, scan **Cancel** on [page D-3](#).



MSI - One Discrete Length

Two Discrete Lengths - This option allows the scanner to decode only those MSI symbols containing either of two selected lengths. Lengths are selected from the numeric bar codes in [Appendix D, Numeric Bar Codes](#). For example, to decode only those MSI symbols containing either 2 or 14 characters, select **MSI - Two Discrete Lengths**, then scan **0, 2, 1**, and then **4**. In case of an error, or to change the selection, scan **Cancel** on [page D-3](#).



MSI - Two Discrete Lengths

Length Within Range - This option allows the scanner to decode an MSI symbol with a specific length range. The length range is selected from numeric bar codes in [Appendix D, Numeric Bar Codes](#). For example, to decode MSI symbols containing between 4 and 12 characters, first scan **MSI - Length Within Range**. Then scan **0, 4, 1**, and **2** (insert a leading zero for single digit numbers). In case of an error, or to change the selection, scan **Cancel** on [page D-3](#).



MSI - Length Within Range

Set Lengths for MSI (continued)

Any Length - This option allows the scanner to decode MSI symbols containing any number of characters within the scanner capability.

- ✓ **NOTE** Due to the construction of the MSI symbology, it is possible for a scan line covering only a portion of the code to be interpreted as a complete scan, yielding less data than is actually encoded in the bar code. To prevent this from happening, select specific lengths (**MSI - One Discrete Length - Two Discrete Lengths**) for MSI applications.



MSI - Any Length

MSI Check Digits

With MSI symbols, one check digit is mandatory and always verified by the reader. The second check digit is optional. If the MSI codes include two check digits, enable the verification of the second check digit by scanning the bar code below.

See [MSI Check Digit Algorithm on page 11-45](#) for the selection of second digit algorithms.



***One MSI Check Digit**



Two MSI Check Digits

Transmit MSI Check Digit(s)

Scan a bar code below to transmit MSI data with or without the check digit.



**Transmit MSI Check Digit(s)
(Enable)**



***Do Not Transmit MSI Check Digit(s)
(Disable)**

MSI Check Digit Algorithm

Two algorithms are possible for the verification of the second MSI check digit. Select the bar code below corresponding to the algorithm used to encode the check digit.



MOD 10/MOD 11



***MOD 10/MOD 10**

GS1 DataBar

The variants of GS1 DataBar are GS1 DataBar-14, GS1 DataBar Expanded, and GS1 DataBar Limited. The limited and expanded versions have stacked variants. Scan the appropriate bar code below to enable or disable each variant of GS1 DataBar.

GS1 DataBar-14

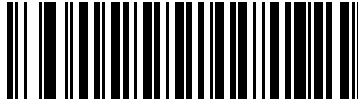

Enable GS1 DataBar-14

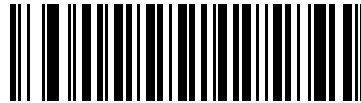

*Disable GS1 DataBar-14

GS1 DataBar Limited

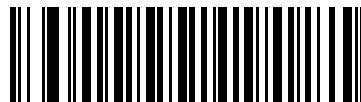

Enable GS1 DataBar Limited



*Disable GS1 DataBar Limited

GS1 DataBar Expanded

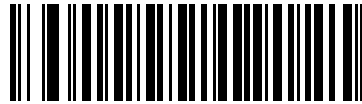

Enable GS1 DataBar Expanded



***Disable GS1 DataBar Expanded**

Convert GS1 DataBar to UPC/EAN

This parameter only applies to GS1 DataBar-14 and GS1 DataBar Limited symbols not decoded as part of a composite symbol. When this conversion is enabled, GS1 DataBar-14 and GS1 DataBar Limited symbols encoding a single zero as the first digit have the leading '010' stripped and the bar code reported as EAN-13.

Bar codes beginning with two or more zeros but not six zeros have the leading '0100' stripped and the bar code reported as UPC-A. The UPC-A Preamble parameter to transmit the system character and country code applies to converted bar codes. Note that neither the system character nor the check digit can be stripped.



Enable Convert GS1 DataBar to UPC/EAN



***Disable Convert GS1 DataBar to UPC/EAN**

Redundancy Level

The scanner offers four levels of decode redundancy. Select higher redundancy levels for lower quality bar codes. As redundancy levels increase, the scanner's aggressiveness decreases.

Select the redundancy level appropriate for the bar code quality.

Redundancy Level 1

The following code types must be successfully read twice before being decoded:

Code Type	Code Length
Codabar	8 characters or less
MSI	4 characters or less
D 2 of 5	8 characters or less
I 2 of 5	8 characters or less



***Redundancy Level 1**

Redundancy Level 2

All code types must be successfully read twice before being decoded.



Redundancy Level 2

Redundancy Level 3

Code types other than the following must be successfully read twice before being decoded. The following codes must be read three times:

Code Type	Code Length
MSI Plessey	4 characters or less
D 2 of 5	8 characters or less
I 2 of 5	8 characters or less
Codabar	8 characters or less

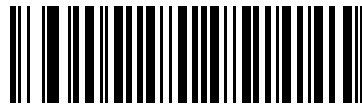

Redundancy Level 3

Redundancy Level 4

All code types must be successfully read three times before being decoded.

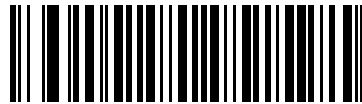

Redundancy Level 4

Security Level

The scanner offers four levels of decode security for UPC/EAN bar codes. Select higher security levels for lower quality bar codes. There is an inverse relationship between security and scanner decode speed, so be sure to choose only that level of security necessary for any given application.

Security Level 0

This default setting allows the scanner to operate fastest, while providing sufficient security in decoding “in-spec” UPC/EAN bar codes.

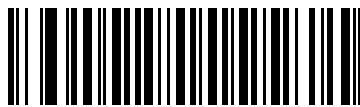

***Security Level 0**

Security Level 1

As bar code quality levels diminish, certain characters become prone to misdecodes before others (i.e., 1, 2, 7, 8). If the scanner is misdecoding poorly printed bar codes, and the misdecodes are limited to these characters, select this security level.

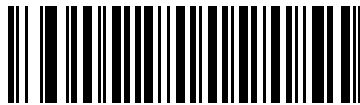

Security Level 1

Security Level 2

If the scanner is misdecoding poorly printed bar codes, and the misdecodes are not limited to characters 1, 2, 7, and 8, select this security level.

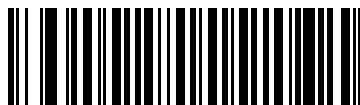

Security Level 2

Security Level 3

If the scanner is still misdecoding, select this security level. Be advised, selecting this option is an extreme measure against misdecoding severely out of spec bar codes. Selecting this level of security can significantly impair the decoding ability of the scanner. If this level of security is necessary, try to improve the quality of the bar codes.

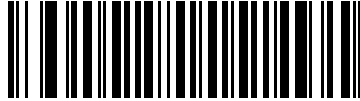

Security Level 3

Bi-directional Redundancy

Use Bi-directional Redundancy for added security for linear code type security levels. When enabled, a bar code must be successfully scanned in both directions (forward and reverse) before reporting a good decode.

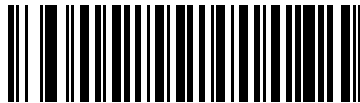

Enable Bi-directional Redundancy



***Disable Bi-directional Redundancy**

Chapter 12 Advanced Data Formatting

Introduction

Advanced Data Formatting (ADF) is a means of customizing data before transmission to the host device. Scan data can be edited to suit particular requirements.

ADF can be implemented through scanning a related series of bar codes, which begin on [page 12-5](#), or by installing the 123Scan utility (see [Chapter 10, 123Scan](#)) which allows the digital imager scanner to be setup and programmed with Advanced Data Formatting (ADF) Rules.

Avoid using ADF formatting with bar codes containing more than 60 characters. To add a prefix or suffix value for such bar codes, use Add Prefix/Suffix setting. Using ADF with longer bar codes transmits the bar code in segments of length 252 or less (depending on the host selected), and applies the rule to each segment

Rules: Criteria Linked to Actions

In ADF, data is customized through **rules**. These rules perform detailed actions when the data meets certain criteria. One rule may consist of single or multiple criteria applied to single or multiple actions.

For instance, a data formatting rule could be the following:

- Criteria:** *When scan data is Code 39, length 12, and data at the start position is the string "129",*
- Actions:** *pad all sends with zeros to length 8,
send all data up to X,
send a space.*

If a Code 39 bar code of 1299X1559828 is scanned, the following is transmitted: 00001299<space>. If a Code 39 bar code of 1299X15598 is scanned, this rule is ignored because the length criteria has not been met.

The rule specifies the editing conditions and requirements before data transmission occurs.

Using ADF Bar Codes

When programming a rule, make sure the rule is logically correct. Plan ahead before scanning.

To program each data formatting rule:

- **Start the Rule.** Scan the [Begin New Rule bar code on page 12-5](#).
- **Criteria.** Scan the bar codes for all pertinent criteria. Criteria can include code type (e.g., Code 128), code length, or data that contains a specific character string (e.g., the digits "129"). These options are described in [Criteria on page 12-8](#).
- **Actions.** Scan all actions related to, or affecting, these criteria. The actions of a rule specify how to format the data for transmission. These options are described in [ADF Bar Code Menu Example on page 12-2](#).
- **Save the Rule.** Scan the *Save Rule* bar code on [page 12-5](#). This places the rule in the "top" position in the rule buffer.
- Some special-purpose bar codes can be useful to correct errors during this process:
Erase Criteria and Start Again, Erase Actions and Start Again, Erase Previously Saved Rule, etc.

Criteria, actions, and entire rules may be erased by scanning the appropriate bar code (see [page 12-6](#)).

Beeper Definitions on page 2-1 guide through the programming steps.

ADF Bar Code Menu Example

This section provides an example of how ADF rules are entered and used for scan data.

An auto parts distribution center wants to encode manufacturer ID, part number, and destination code into their own Code 128 bar codes. The distribution center also has products that carry UPC bar codes, placed there by the manufacturer. The Code 128 bar codes have the following format:

MMMMMPPPPDD

Where: M = Manufacturer ID
 P = Part Number
 D = Destination Code

The distribution center uses a PC with dedicated control characters for manufacturer ID <CTRL M>, part number <CTRL P>, and destination code <CTRL D>. At this center the UPC data is treated as manufacturer ID code.

The following rules need to be entered:

When scanning data of code type Code 128, send the next 5 characters, send the manufacturer ID key <CTRL M>, send the next 5 characters, send the part number key <CTRL P>, send the next 2 characters, send the destination code key <CTRL D>.

When scanning data of code type UPC/EAN, send all data, send the manufacturer ID key <CTRL M>.

To enter these rules, follow the steps below:

Rule 1: The Code 128 Scanning Rule

Step	Bar Code	On Page	Beep Indication
1	Begin New Rule	12-5	High High
2	Code 128	12-8	High High
3	Send next 5 characters	12-22	High High
4	Send <CTRL M>	12-44	High High
5	Send next 5 characters	12-22	High High
6	Send <CTRL P>	12-44	High High
7	Send next 2 characters	12-21	High High
8	Send <CTRL D>	12-42	High High
9	Save Rule	12-5	High Low High Low

Rule 2: The UPC Scanning Rule

Step	Bar Code	On Page	Beep Indication
1	Begin New Rule	12-5	High High
2	UPC/EAN	12-9	High High
3	Send all remaining data	12-21	High High
4	Send <CTRL M>	12-44	High High
5	Save Rule	12-5	High Low High Low

To correct any errors made while entering this rule, scan the *Quit Entering Rules* bar code on [page 12-6](#). If the rule is already saved, scan the *Erase Previously Saved Rule* bar code on [page 12-6](#).

Alternate Rule Sets

ADF rules may be grouped into one of four alternate sets which can be turned on and off when needed. This is useful to format the same message in different ways. For example, a Code 128 bar code contains the following information:

Class (2 digits), Stock Number (8) digits, Price (5 digits)

The bar code might look like this:

245671243701500

where:

Class = 24

Stock Number = 56712437

Price = 01500

Ordinarily, data is sent as follows:

24 (class key)

56712437 (stock key)

01500 (enter key)

But, when there is a sale, send only the following:

24 (class key)

56712437 (stock key)

and the cashier will key the price manually.

To implement this, first enter an ADF rule that applies to the normal situation, such as:

Scan Rule Belongs to Set 1. When scanning a bar code of length 15, send the next 2 characters, send the class key, send the next 8 characters, send the stock key, send the data that remains, send the Enter key.

The “sale” rule may look like this:

Scan Rule Belongs to Set 2. When scanning a bar code of length 15, send the next 2 characters, send the class key, send the next 8 characters, send the stock key.

To switch between the two sets of rules, a “switching rule” must be programmed. This rule specifies what type of bar code must be scanned to switch between the rule sets. For example, in the case of the “sale” rule above, the rule programmer wants the cashier to scan the bar code “M” before a sale. To do this, a rule can be entered as follows:

When scanning a bar code of length 1 that begins with “M”, select rule set number 1.

Another rule could be programmed to switch back.

When scanning a bar code of length 1 that begins with “N”, turn off rule set number 1.

The switching back to normal rules can also be done in the “sale” rule. For example, the rule may look like this:

When scanning a bar code of length 15, send the next 2 characters, send the class key, send the next 8 characters, send the stock key, turn off rule set 1.

For optimal results, scan the *Disable All Rule Sets* bar code on [page 12-7](#) after programming a rule belonging to an alternate rule set.

In addition to enabling and disabling rule sets within the rules, enable or disable them by scanning the appropriate bar codes on [page 12-7](#).

Rules Hierarchy (in Bar Codes)

The order of programming individual rules is important. The most general rule should be programmed first.

All programmed rules are stored in a buffer. As they are programmed, they are stored at the “top” of a rules list. If three rules have been created, the list would be configured as follows:

Third Rule
Second Rule
First Rule

When data is scanned, the rules list is checked from top to bottom to determine if the criteria matches (and therefore, if the actions should occur). Input is modified into the data format specified by the first matching set of criteria it finds. Be sure to program the most general rule last.

For example, if the THIRD rule states:

When scanning a bar code of any length, send all data, then send the ENTER key.

And the SECOND rule states:

When scanning a Code 128 bar code of length 12, send the first four characters, then send the ENTER key, then send all remaining data.

If a Code 128 bar code of length 12 were scanned, the THIRD rule would be in effect. The SECOND rule would appear to not function.

Note also that ADF rules are actually created when using the standard data editing functions. Scan options are entered as ADF rules, and the hierarchy mentioned above also applies to them. For the digital imager scanner, this applies to prefix/suffix programming in the parameter *Scan Data Transmission Format*.

These rules reside in the same “rule list” as ADF Rules, so the order of their creation is also important.

Default Rules

Every unit has a default rule to send all scan data. Units with custom software may have one or more default rules burned in. The rules hierarchy checks user programmable rules first, then the default rules. Default rules can be disabled by entering the following general rule in the user programmable buffer:

When receiving scan data, send all data.

Since this rule always applies, ADF will never go into the default rules.

Special Commands

Pause Duration

This parameter, along with the Send Pause parameter on [page 12-25](#), allows a pause to be inserted in the data transmission. Pauses are set by scanning a two-digit number (i.e., two bar codes), and are measured in 0.1 second intervals. For example, scanning bar codes “0” and “1” inserts a 0.1 second pause; “0” and “5” inserts a 0.5 second delay. See [Appendix D, Numeric Bar Codes](#). To correct an error or change a selection, scan *Cancel on page D-3*.



Pause Duration

Begin New Rule

Scan the bar code below to start entering a new rule



Begin New Rule

Save Rule

Scan the bar code below to save the rule.



Save Rule

Erase

Use these bar codes to erase criteria, actions, or rules.



Erase Criteria And Start Again



Erase Actions And Start Again



Erase Previously Saved Rule



Erase All Rules

Quit Entering Rules

Scan the bar code below to quit entering rules.



Quit Entering Rules

Disable Rule Set

Use these bar codes to disable rule sets.



Disable Rule Set 1



Disable Rule Set 2



Disable Rule Set 3



Disable Rule Set 4



Disable All Rule Sets

Criteria

Code Types

Select any number of code types to be affected. All selected codes must be scanned in succession, prior to selecting other criteria. *To select all code types, do not scan any code type.*

Scan the bar codes for all code types desired before selecting other criteria.



Code 39



Codabar



GS1 DataBar-14



GS1 DataBar Limited

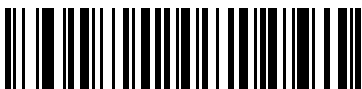

GS1 DataBar Expanded



Code 128



D 2 OF 5

Code Types (continued)



IATA 2 OF 5



I 2 OF 5



Code 93



UPC-A



UPC-E



EAN-8



EAN-13

Code Types (continued)



MSI



UCC/EAN 128



UPC-E1



Bookland EAN



Trioptic Code 39



Code 11



ISBT 128

Code Types (continued)



ISBT 128



Coupon Code

Code Lengths

Define the number of characters the selected code type must contain. *Do not select any code length to select code types of any length.*

Scan these bar codes to define the number of characters the selected code types must contain. Select one length per rule only.



1 Character



2 Characters



3 Characters



4 Characters



5 Characters



6 Characters

Code Lengths (continued)



7 Characters



8 Characters



9 Characters



10 Characters



11 Characters



12 Characters



13 Characters

Code Lengths (continued)



14 Characters



15 Characters



16 Characters



17 Characters



18 Characters



19 Characters



20 Characters

Code Lengths (continued)



21 Characters



22 Characters



23 Characters



24 Characters



25 Characters



26 Characters



27 Characters

Code Lengths (continued)



28 Characters



29 Characters



30 Characters

Message Containing A Specific Data String

Use this feature to select whether the formatting affects data that begins with a specific character or data string, or contains a specific character or data string.

There are 4 features:

- Specific String at Start
- Specific String, Any Location
- Any Message OK
- Rule Belongs to Set

Specific String at Start

Scan the bar code below, then scan the bar codes representing the desired character or characters (up to a total of 8) in the *Alphanumeric Keyboard* on page 12-86.

After scanning the following bar code:

1. Enter a string using the *Alphanumeric Keyboard* on page 12-86.
2. Scan *End of Message* bar code on [page 12-95](#).



Specific String At Start

Specific String, Any Location

Scan the bar code below, then, using the *Numeric Keypad on page 12-18*, scan a two-digit number representing the **position** (use a leading “zero” if necessary). Then scan the desired character or characters (up to a total of 8) on the *Alphanumeric Keyboard on page 12-86*, followed by the *End of Message* bar code on [page 12-95](#).

After scanning the following bar code:

1. Enter a location using the *Numeric Keypad on page 12-18*.
2. Enter a string using the *Alphanumeric Keyboard on page 12-86*.
3. Scan *End of Message* bar code on [page 12-95](#).



Specific String Any Location

Any Message OK

By not scanning any bar code, all selected code types are formatted, regardless of information contained.

Numeric Keypad

Bar codes on this page should not be confused with those on the alphanumeric keyboard.



0



1



2



3



4



5



6

Numeric Keypad (continued)



7



8



9



Cancel

Rule Belongs To Set

Select the set a rule belongs to. (There are four possible rule sets.) See *Alternate Rule Sets* on page 12-3 for more information about rule sets.

Scan a bar code below to select which set a rule belongs to.



Rule Belongs To Set 1



Rule Belongs To Set 2



Rule Belongs To Set 3



Rule Belongs To Set 4

Actions

Select how to format the data for transmission.

Send Data

Send all data that follows, send all data up to a specific character selected from the *Alphanumeric Keyboard on page 12-86*, or send the next *X* characters. Note that only bar codes for **Send Next 1 to 20** appear here, and can be scanned multiple times to send values greater than 20. For instance, to send the next 28 characters, scan **Send Next 20 Characters**, then **Send Next 8 Characters**.



Send Data Up To Character



Send All Data That Remains



Send Next Character



Send Next 2 Characters



Send Next 3 Characters



Send Next 4 Characters

Send Data (continued)



Send Next 5 Characters



Send Next 6 Characters



Send Next 7 Characters



Send Next 8 Characters



Send Next 9 Characters



Send Next 10 Characters



Send Next 11 Characters

Send Data (continued)



Send Next 12 Characters



Send Next 13 Characters



Send Next 14 Characters



Send Next 15 Characters



Send Next 16 Characters



Send Next 17 Characters



Send Next 18 Characters

Send Data (continued)**Send Next 19 Characters****Send Next 20 Characters****Setup Field(s)****Table 12-1** *Setup Field(s) Definitions*

Parameter	Description	Page
Move Cursor		
Move Cursor To a Character	Scan the <i>Move Cursor To Character</i> on page 12-25, then any printable ASCII character from the <i>Alphanumeric Keyboard</i> on page 12-86. When this is used, the cursor moves to the position after the matching character. If the character is not there, the rule fails and ADF tries the next rule.	12-25
Move Cursor to Start of Data	Scan this bar code to move cursor to the beginning of the data.	12-25
Move Cursor Past a Character	This parameter moves the cursor past all sequential occurrences of a selected character. For example, if the selected character is 'A', then the cursor moves past 'A', 'AA', 'AAA', etc. Scan the <i>Move Cursor Past Character</i> on page 12-25, then select a character from the <i>Alphanumeric Keyboard</i> on page 12-86. If the character is not there, the cursor does not move (i.e., has no effect).	12-25
Skip Ahead "N" Characters	Scan one of these bar codes to select the number of positions ahead to move the cursor.	12-26
Skip Back "N" Characters	Scan one of these bar codes to select the number of positions back to move the cursor.	12-28
Send Preset Value	Send Values 1 through 6 by scanning the appropriate bar code. These values must be set using the prefix/suffix values in Table 7-4 on page 7-20 . Value 1 = Scan Suffix Value 2 = Scan Prefix Values 3-6 are not applicable	12-28

Move Cursor

Scan a bar code below to move the cursor in relation to a specified character. Then enter a character by scanning a bar code from the *Alphanumeric Keyboard on page 12-86*.

✓ **NOTE** If there is no match when the rule is interpreted and the rule fails, the next rule is checked.



Move Cursor To Character



Move Cursor To Start



Move Cursor Past Character

Send Pause

Scan the bar code below to insert a pause in the transmission of data. The length of this pause is controlled by the value of the Pause Duration parameter.



Send Pause

Skip Ahead

Use the following bar codes to skip ahead characters.



Skip Ahead 1 Character



Skip Ahead 2 Characters



Skip Ahead 3 Characters



Skip Ahead 4 Characters



Skip Ahead 5 Characters



Skip Ahead 6 Characters

Skip Ahead (continued)



Skip Ahead 7 Characters



Skip Ahead 8 Characters



Skip Ahead 9 Characters



Skip Ahead 10 Characters

Skip Back

Use the following bar codes to skip back characters.



Skip Back 1 Character



Skip Back 2 Characters



Skip Back 3 Characters



Skip Back 4 Characters



Skip Back 5 Characters

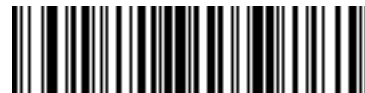

Skip Back 6 Characters

Skip Back (continued)**Skip Back 7 Characters****Skip Back 8 Characters****Skip Back 9 Characters****Skip Back 10 Characters****Send Preset Value**

Use these bar codes to send preset values. These values must be set using the Scan Prefix and Scan Suffix bar codes on [page 5-12](#).

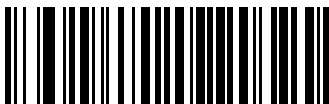
**Send Prefix****Send Suffix**

Modify Data

Modify data in the ways listed. The following actions work for all send commands that follow it within a rule. Programming *pad zeros to length 6, send next 3 characters, stop padding, send next 5 characters*, adds three zeros to the first send, and the next send is unaffected by the padding. These options do not apply to the **Send Keystroke** or **Send Preset Value** options.

Remove All Spaces

To remove all spaces in the send commands that follow, scan the bar code below.



Remove All Spaces

Crunch All Spaces

To leave one space between words, scan the bar code below. This also removes all leading and trailing spaces.



Crunch All Spaces

Stop Space Removal

Scan the bar code below to disable space removal.



Stop Space Removal

Remove Leading Zeros

Scan the bar code below to remove all leading zeros.



Remove Leading Zeros

Stop Zero Removal

Scan the bar code below to disable the removal of zeros.



Stop Zero Removal

Pad Data with Spaces

To pad data to the left, scan the bar code containing the desired number of spaces. This parameter is activated by Send commands.



Pad Spaces To Length 1



Pad Spaces To Length 2



Pad Spaces To Length 3



Pad Spaces To Length 4



Pad Spaces To Length 5



Pad Spaces To Length 6



Pad Spaces To Length 7

Pad Data with Spaces (continued)



Pad Spaces To Length 8



Pad Spaces To Length 9



Pad Spaces To Length 10



Pad Spaces To Length 11



Pad Spaces To Length 12



Pad Spaces To Length 13



Pad Spaces To Length 14

Pad Data with Spaces (continued)



Pad Spaces To Length 15



Pad Spaces To Length 16



Pad Spaces To Length 17



Pad Spaces To Length 18



Pad Spaces To Length 19



Pad Spaces To Length 20



Pad Spaces To Length 21

Pad Data with Spaces (continued)



Pad Spaces To Length 22



Pad Spaces To Length 23



Pad Spaces To Length 24



Pad Spaces To Length 25



Pad Spaces To Length 26



Pad Spaces To Length 27



Pad Spaces To Length 28

Pad Data with Spaces (continued)



Pad Spaces To Length 29



Pad Spaces To Length 30



Stop Pad Spaces

Pad Data with Zeros

To pad data to the left, scan the bar code containing the desired number of zeros. This parameter is activated by Send commands.



Pad Zeros To Length 1



Pad Zeros To Length 2



Pad Zeros To Length 3



Pad Zeros To Length 4



Pad Zeros To Length 5



Pad Zeros To Length 6

Pad Data with Zeros (continued)



Pad Zeros To Length 7



Pad Zeros To Length 8



Pad Zeros To Length 9



Pad Zeros To Length 10

Pad Data with Zeros (continued)



Pad Zeros To Length 11



Pad Zeros To Length 12



Pad Zeros To Length 13



Pad Zeros To Length 14



Pad Zeros To Length 15



Pad Zeros To Length 16



Pad Zeros To Length 17

Pad Data with Zeros (continued)



Pad Zeros To Length 18



Pad Zeros To Length 19



Pad Zeros To Length 20



Pad Zeros To Length 21



Pad Zeros To Length 22



Pad Zeros To Length 23



Pad Zeros To Length 24

Pad Data with Zeros (continued)



Pad Zeros To Length 25



Pad Zeros To Length 26



Pad Zeros To Length 27



Pad Zeros To Length 28



Pad Zeros To Length 29



Pad Zeros To Length 30



Stop Pad Zeros

Beeps

Select a beep sequence for each ADF rule.



Beep Once



Beep Twice



Beep Three Times

Send Keystroke (Control Characters and Keyboard Characters)

Control Characters

Scan the “Send ___” bar code for the keystroke to send



Send Control 2



Send Control A



Send Control B



Send Control C



Send Control D



Send Control E

Control Characters (continued)



Send Control F



Send Control G



Send Control H



Send Control I



Send Control J



Send Control K

Control Characters (continued)



Send Control L



Send Control M



Send Control N



Send Control O



Send Control P



Send Control Q

Control Characters (continued)



Send Control R



Send Control S



Send Control T



Send Control U



Send Control V



Send Control W

Control Characters (continued)



Send Control X



Send Control Y



Send Control Z



Send Control [



**Send Control **



Send Control]

Control Characters (continued)



Send Control 6



Send Control -

Keyboard Characters

Scan the "Send ___" bar code for the keyboard characters to send.



Send Space



Send !



Keyboard Characters (continued)



Send \$



Send %



Send &



Send '



Send (



Send)



Send *

Keyboard Characters (continued)



Send +



Send ,



Send -



Send .



Send /



Send 0



Send 1

Keyboard Characters (continued)



Send 2



Send 3



Send 4



Send 5



Send 6



Send 7



Send 8

Keyboard Characters (continued)



Send 9



Send :



Send ;



Send <



Send =



Send >



Send ?

Keyboard Characters (continued)



Send @



Send A



Send B



Send C



Send D



Send E



Send F

Keyboard Characters (continued)



Send G



Send H



Send I



Send J



Send K



Send L



Send M

Keyboard Characters (continued)



Send N



Send O



Send P



Send Q



Send R



Send S



Send T

Keyboard Characters (continued)



Send U



Send V



Send W



Send X



Send Y



Send Z



Send [

Keyboard Characters (continued)



**Send **



Send]



Send ^



Send _



Send `



Send a



Send b

Keyboard Characters (continued)



Send c



Send d



Send e



Send f



Send g



Send h



Send i

Keyboard Characters (continued)



Send j



Send k



Send l



Send m



Send n



Send o



Send p

Keyboard Characters (continued)



Send q



Send r



Send s



Send t



Send u



Send v



Send w

Keyboard Characters (continued)



Send x



Send y



Send z



Send {



Send |



Send }



Send ~

Send ALT Characters



Send Alt 2



Send Alt A



Send Alt B



Send Alt C



Send Alt D



Send Alt E



Send Alt F

Send ALT Characters (continued)



Send Alt G



Send Alt H



Send Alt I



Send Alt J



Send Alt K



Send Alt L



Send Alt M

Send ALT Characters (continued)



Send Alt N



Send Alt O



Send Alt P



Send Alt Q



Send Alt R



Send Alt S



Send Alt T

Send ALT Characters (continued)



Send Alt U



Send Alt V



Send Alt W



Send Alt X



Send Alt Y



Send Alt Z

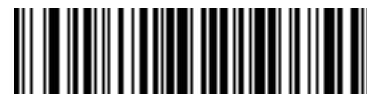

Send Alt [

Send ALT Characters (continued)



**Send Alt **



Send Alt]

Send Keypad Characters



Send Keypad *



Send Keypad +



Send Keypad -



Send Keypad .



Send Keypad /



Send Keypad 0



Send Keypad 1

Send Keypad Characters (continued)



Send Keypad 2



Send Keypad 3



Send Keypad 4



Send Keypad 5



Send Keypad 6



Send Keypad 7



Send Keypad 8

Send Keypad Characters (continued)



Send Keypad 9



Send Keypad Enter



Send Keypad Numlock



Send Break Key



Send Delete Key



Send Page Up Key



Send End Key

Send Keypad Characters (continued)



Send Page Down Key



Send Pause Key



Send Scroll Lock Key



Send Backspace Key



Send Tab Key



Send Print Screen Key



Send Insert Key

Send Keypad Characters (continued)



Send Home Key



Send Enter Key



Send Escape Key



Send Up Arrow Key



Send Down Arrow Key



Send Left Arrow Key



Send Right Arrow Key

Send Function Key



Send F1 Key



Send F2 Key



Send F3 Key



Send F4 Key



Send F5 Key



Send F6 Key



Send F7 Key

Send Function Key (continued)



Send F8 Key



Send F9 Key



Send F10 Key



Send F11 Key



Send F12 Key



Send F13 Key



Send F14 Key

Send Function Key (continued)



Send F15 Key



Send F16 Key



Send F17 Key



Send F18 Key



Send F19 Key



Send F20 Key



Send F21 Key

Send Function Key (continued)



Send F22 Key



Send F23 Key



Send F24 Key



Send PF1 Key



Send PF2 Key



Send PF3 Key



Send PF4 Key

Send Function Key (continued)



Send PF5 Key



Send PF6 Key



Send PF7 Key



Send PF8 Key



Send PF9 Key



Send PF10 Key



Send PF11 Key

Send Function Key (continued)



Send PF12 Key



Send PF13 Key



Send PF14 Key



Send PF15 Key



Send PF16 Key



Send PF17 Key



Send PF18 Key

Send Function Key (continued)



Send PF19 Key



Send PF20 Key



Send PF21 Key



Send PF22 Key



Send PF23 Key



Send PF24 Key



Send PF25 Key

Send Function Key (continued)



Send PF26 Key



Send PF27 Key



Send PF28 Key



Send PF29 Key



Send PF30 Key

Send Right Control Key

The “Send Right Control Key” action will send a tap (press and release) of the Right Control Key.



Send Right Control Key

Send Graphic User Interface (GUI) Characters

The “Send Graphic User Interface Character” actions will tap the specified key while holding the System Dependent Graphic User Interface (GUI) Key. The definition of the Graphic User Interface key is dependant upon the attached system:

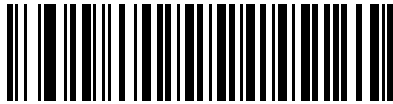

Send GUI 0

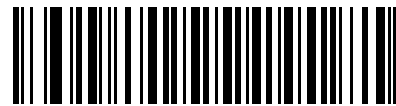

Send GUI 1

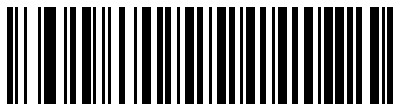

Send GUI 2



Send GUI 3

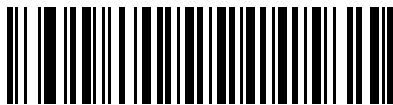

Send GUI 4

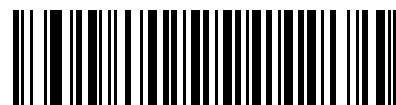

Send GUI 5

Send Graphic User Interface (GUI) Characters (continued)



Send GUI 6



Send GUI 7

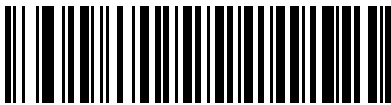

Send GUI 8

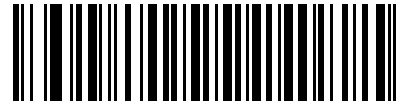

Send GUI 9

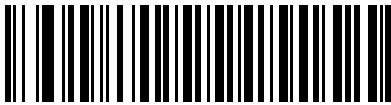

Send GUI A

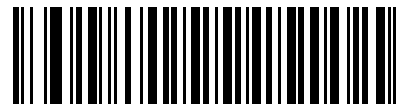

Send GUI B



Send GUI C

Send Graphic User Interface (GUI) Characters (continued)



Send GUI D

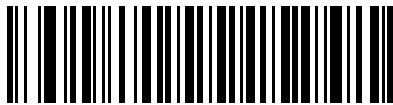

Send GUI E

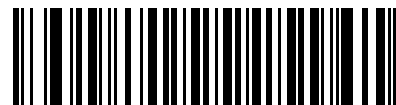

Send GUI F



Send GUI G

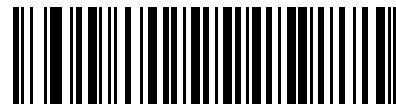

Send GUI H



Send GUI I

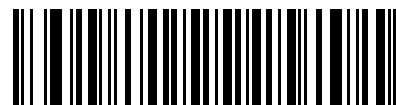

Send GUI J

Send Graphic User Interface (GUI) Characters (continued)



Send GUI K



Send GUI L

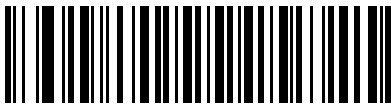

Send GUI M

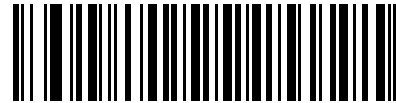

Send GUI N

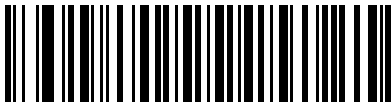

Send GUI O

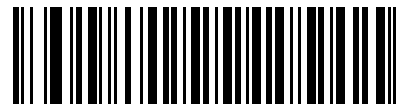

Send GUI P



Send GUI Q

Send Graphic User Interface (GUI) Characters (continued)



Send GUI R

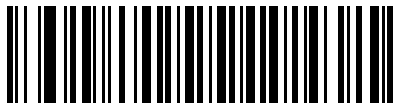

Send GUI S

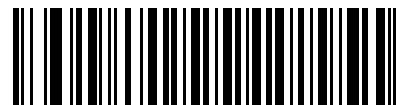

Send GUI T



Send GUI U

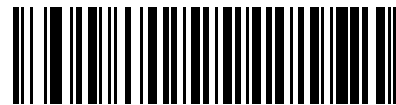

Send GUI V



Send GUI W

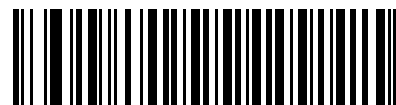

Send GUI X

Send Graphic User Interface (GUI) Characters (continued)



Send GUI Y



Send GUI Z

Turn On/Off Rule Sets

Use these bar codes to turn rule sets on and off.



Turn On Rule Set 1



Turn On Rule Set 2



Turn On Rule Set 3



Turn On Rule Set 4

Turn On/Off Rule Sets (continued)

Use these bar codes to turn rule sets on and off.



Turn Off Rule Set 1



Turn Off Rule Set 2



Turn Off Rule Set 3



Turn Off Rule Set 4

Alphanumeric Keyboard



Space



#



\$



%



*



+



-
(Dash)

Alphanumeric Keyboard (continued)

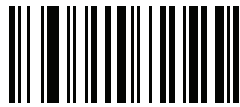

,



.



!



/



“



&



'



(

Alphanumeric Keyboard (continued)



)



:



;



<



=



>



?

Alphanumeric Keyboard (continued)



@



[



\



]



^



(Underscore)



,

Alphanumeric Keyboard (continued)

✓ **NOTE** Numeric bar codes below should not be confused with those on the numeric keypad.



0



1



2



3



4



5

Alphanumeric Keyboard (continued)



6



7



8



9



A



B



C

Alphanumeric Keyboard (continued)



E



D



F



G



H



I



J

Alphanumeric Keyboard (continued)



K



L



M



N



O



P



Q

Alphanumeric Keyboard (continued)



S



R



T



U



V



W



X

Alphanumeric Keyboard (continued)



Y



Z



Cancel



End of Message



a



b



c

Alphanumeric Keyboard (continued)



e



d



f



g



h



i



j

Alphanumeric Keyboard (continued)



k



l



m



n



o



p



q

Alphanumeric Keyboard (continued)



s



r



t



u



v



w



x

Alphanumeric Keyboard (continued)



y



z



{



|



}



~

Appendix A Standard Default Parameters

Table A-1 Standard Default Parameters Table

Parameter	Default	Page Number
Radio Communications		
Bluetooth Host (Host Type)	Cradle Host	4-5
Bluetooth Friendly Name	Scanner name and serial number	4-7
Discoverable Mode	General	4-7
Country Keyboard Types (Country Code)	North American	4-9
HID Keyboard Keystroke Delay	No Delay (0 msec)	4-11
CAPS Lock Override	Disable	4-11
Ignore Unknown Characters	Enable	4-12
Emulate Keypad	Disable	4-12
Keyboard FN1 Substitution	Disable	4-13
Function Key Mapping	Disable	4-13
Simulated Caps Lock	Disable	4-14
Convert Case	No Case Conversion	4-14
Beep on Reconnect Attempt	Disable	4-15
Reconnect Attempt Interval	30 sec	4-16
Auto-reconnect in Bluetooth Keyboard Emulation (HID Slave) Mode	On Bar Code Data	4-18
Modes of Operation (Point-to-Point/Multipoint-to-Point)	Point-to-Point	4-20

¹User selection is required to configure this interface and this is the most common selection.

Table A-1 Standard Default Parameters Table (Continued)

Parameter	Default	Page Number
Parameter Broadcast (Cradle Host Only)	Enable	4-21
Pairing Modes	Unlocked	4-22
Pairing on Contacts	Disable	4-23
Connection Maintenance Interval	15 min	4-24
Authentication	Disable	4-27
Pin Code	Static	4-28
Encryption	Disable	4-29
User Preferences		
Default Parameters	Restore Defaults	5-4
Beeper Tone	Medium	5-5
Beeper Volume	High	5-6
Laser On Time	3.0 sec	5-7
Beep After Good Decode	Enable	5-7
Trigger Mode	Level	5-8
Aim Duration	0.0 sec	5-9
Beep on Insertion	Enable	5-9
Time Delay to Reduced Power Mode	1 Second	5-10
Transmit Code ID Character	None	5-11
Scan Angle	Normal Angle	5-11
Prefix Value	7013 <CR><LF>	5-12
Suffix Value	7013 <CR><LF>	5-12
Scan Data Transmission Format	Data As Is	5-13
FN1 Substitution Values	Set FN1 Substitution Value	5-15
Transmit "No Read" Message	Disable No Read	5-15
Synapse Interface	Standard Synapse Connection	5-16
Batch Mode	Normal (Do Not Batch Data)	5-17
Report Scanner Version		5-19

¹User selection is required to configure this interface and this is the most common selection.

Table A-1 Standard Default Parameters Table (Continued)

Parameter	Default	Page Number
Report Scan Engine Version		5-19
Report MIMIC Version		5-19
Report Synapse Cable		5-19
Keyboard Wedge Host Parameters		
Keyboard Wedge Host Type	IBM PC/AT& IBM PC Compatibles ¹	6-4
Keyboard Wedge Country Types (Country Codes)	North American	6-5
Ignore Unknown Characters	Enable	6-7
Keystroke Delay	0 msec (No Delay)	6-7
Intra-Keystroke Delay	Disable	6-8
Alternate Numeric Keypad Emulation	Disable	6-8
Caps Lock On	Disable	6-9
Caps Lock Override	Disable	6-9
Convert Wedge Data	Do Not Convert Wedge Data	6-10
Function Key Mapping	Disable	6-10
FN1 Substitution	Disable	6-11
Send Make and Break	Send Make and Break Scan Codes	6-11
RS-232 Host Parameters		
RS-232 Host Types	Standard RS-232 ¹	7-6
Baud Rate	9600	7-7
Parity	None	7-9
Check Receive Errors	Enable	7-10
Stop Bit Select	1 Stop Bit	7-11
Data Bits	8-Bit	7-11
Hardware Handshaking	None	7-12
Software Handshaking	None	7-14
Host Serial Response Time-out	Minimum: 2 Sec	7-16

¹User selection is required to configure this interface and this is the most common selection.

Table A-1 Standard Default Parameters Table (Continued)

Parameter	Default	Page Number
RTS Line State	Host: Low RTS	7-17
Beep on <BEL>	Disable	7-17
Intercharacter Delay	Minimum: 0 msec	7-18
Nixdorf Mode A/B and OPOS/JPOS Beep/LED Options	Normal Operation	7-19
Ignore Unknown Characters	Send Bar Code	7-20
USB Host Parameters		
USB Device Type	HID Keyboard Emulation	8-5
USB Country Keyboard Types (Country Codes)	North American	8-6
USB Keystroke Delay	No Delay (0 msec)	8-8
USB CAPS Lock Override	Disable	8-9
USB Ignore Unknown Characters	Enable	8-9
Emulate Keypad	Disable	8-10
USB Keyboard FN1 Substitution	Disable	8-10
Function Key Mapping	Disable	8-11
Simulated Caps Lock	Disable	8-11
Convert Case	No Case Conversion	8-12
IBM 468X/469X Host Parameters		
Port Address	None Selected	9-4
Convert Unknown to Code 39	Disable	9-4
123Scan Configuration Tool		
123Scan Configuration	None ¹	10-1
UPC/EAN		
UPC-A	Enable	11-5
UPC-E	Enable	11-5
UPC-E1	Disable	11-6
EAN-13/JAN 13	Enable	11-6
EAN-8/JAN 8	Enable	11-7
Bookland EAN	Disable	11-7

¹User selection is required to configure this interface and this is the most common selection.

Table A-1 Standard Default Parameters Table (Continued)

Parameter	Default	Page Number
Decode UPC/EAN/JAN Supplementals (2 and 5 digits)	Ignore Supplementals	11-8
User-Programmable Supplementals		11-11
UPC/EAN/JAN Supplemental Redundancy	7	11-12
Transmit UPC-A Check Digit	Enable	11-12
Transmit UPC-E Check Digit	Enable	11-12
Transmit UPC-E1 Check Digit	Enable	11-12
UPC-A Preamble	System Character	11-14
UPC-E Preamble	System Character	11-15
UPC-E1 Preamble	System Character	11-16
Convert UPC-E to A	Disable	11-17
Convert UPC-E1 to A	Disable	11-17
EAN-8/JAN-8 Extend	Disable	11-18
Bookland ISBN Format	10	11-19
UCC Coupon Extended Code	Disable	11-20
Code 128		
Code 128	Enable	11-21
UCC/EAN-128	Enable	11-22
ISBT 128	Enable	11-22
Code 39		
Code 39	Enable	11-23
Trioptic Code 39	Disable	11-23
Convert Code 39 to Code 32	Disable	11-24
Code 32 Prefix	Disable	11-24
Set Length(s) for Code 39	2 to 55	11-25
Code 39 Check Digit Verification	Disable	11-26
Transmit Code 39 Check Digit	Disable	11-26
Code 39 Full ASCII Conversion	Disable	11-27

¹User selection is required to configure this interface and this is the most common selection.

Table A-1 Standard Default Parameters Table (Continued)

Parameter	Default	Page Number
Code 93		
Code 93	Disable	11-28
Set Lengths for Code 93	4 to 55	11-28
Code 11		
Code 11	Disable	11-30
Set Lengths for Code 11	4 to 55	11-31
Code 11 Check Digit Verification	One Check Digit	11-32
Transmit Code 11 Check Digits	Disable	11-33
Interleaved 2 of 5 (I 2 of 5)		
Interleaved 2 of 5 (I 2 of 5)	Enable	11-34
Set Lengths for Interleaved 2 of 5	14	11-34
I 2 of 5 Check Digit Verification	Disable	11-36
Transmit I 2 of 5 Check Digit	Disable	11-36
Convert I 2 of 5 to EAN-13	Disable	11-37
Discrete 2 of 5 (D 2 of 5)		
Discrete 2 of 5	Disable	11-37
Set Lengths for D 2 of 5	12	11-38
Codabar (NW - 7)		
Codabar	Disable	11-39
Set Lengths for Codabar	5 to 55	11-40
CLSI Editing	Disable	11-41
NOTIS Editing	Disable	11-41
MSI		
MSI	Disable	11-42
Set Lengths for MSI	1 to 55	11-43
MSI Check Digits	One	11-44
Transmit MSI Check Digit(s)	Disable	11-45
MSI Check Digit Algorithm	Mod 10/Mod 10	11-45

¹User selection is required to configure this interface and this is the most common selection.

Table A-1 Standard Default Parameters Table (Continued)

Parameter	Default	Page Number
GS1 DataBar		
GS1 DataBar-14	Disable	11-46
GS1 DataBar Limited	Disable	11-46
GS1 DataBar Expanded	Disable	11-47
Convert GS1 DataBar to UPC/EAN	Disable	11-47
Symbology - Specific Security Levels		
Redundancy Level	1	11-48
Security Levels	0	11-50
Bi-directional Redundancy	Disable	11-51
¹User selection is required to configure this interface and this is the most common selection.		

Appendix B Programming Reference

Symbol Code Identifiers

Table B-1 *Symbol Code Characters*

Code Character	Code Type
A	UPC/EAN
B	Code 39, Code 39 Full ASCII, Code 32
C	Codabar
D	Code 128, ISBT 128
E	Code 93
F	Interleaved 2 of 5
G	Discrete 2 of 5, or Discrete 2 of 5 IATA
H	Code 11
J	MSI
K	UCC/EAN-128
L	Bookland EAN
M	Trioptic Code 39
R	GS1 DataBar Family

AIM Code Identifiers

Each AIM Code Identifier contains the three-character string **Jcm** where:

- J = Flag Character (ASCII 93)
- c = Code Character (see [Table B-2](#))
- m = Modifier Character (see [Table B-3](#))

Table B-2 *Aim Code Characters*

Code Character	Code Type
A	Code 39, Code 39 Full ASCII, Code 32
C	Code 128 (all variants)
E	UPC/EAN
e	GS1 DataBar Family
F	Codabar
G	Code 93
H	Code 11
I	Interleaved 2 of 5
M	MSI
S	Discrete 2 of 5, IATA 2 of 5
X	Code 39 Trioptic, Bookland EAN

The modifier character is the sum of the applicable option values based on [Table B-3](#).

Table B-3 *Modifier Characters*

Code Type	Option Value	Option
Code 39	0	No check character or Full ASCII processing.
	1	Reader has checked one check character.
	3	Reader has checked and stripped check character.
	4	Reader has performed Full ASCII character conversion.
	5	Reader has performed Full ASCII character conversion and checked one check character.
	7	Reader has performed Full ASCII character conversion and checked and stripped check character.
	Example: A Full ASCII bar code with check character W, A+I+MI+DW , is transmitted as JA7AIMID where 7 = (3+4).	
Trioptic Code 39	0	No option specified at this time. Always transmit 0.
	Example: A Trioptic bar code 412356 is transmitted as JX0412356 .	
Code 128	0	Standard data packet, no Function code 1 in first symbol position.
	1	Function code 1 in first symbol character position.
	2	Function code 1 in second symbol character position.
	Example: A Code (EAN) 128 bar code with Function 1 character ^{FNC1} in the first position, AIMID is transmitted as JC1AIMID .	
I 2 of 5	0	No check digit processing.
	1	Reader has validated check digit.
	3	Reader has validated and stripped check digit.
	Example: An I 2 of 5 bar code without check digit, 4123, is transmitted as JI04123 .	
Codabar	0	Standard Codabar.
	1	ABC Codabar.
	3	Reader has stripped check digit before transmission.
	Example: A Codabar bar code without check digit, 4123, is transmitted as JF04123	
Code 93	0	No options specified at this time. Always transmit 0.
	Example: A Code 93 bar code 012345678905 is transmitted as JG0012345678905 .	

Table B-3 *Modifier Characters (Continued)*

Code Type	Option Value	Option
MSI	0	Check digits are sent.
	1	No check digit is sent.
	Example: An MSI bar code 4123, with a single check digit checked, is transmitted as JM1 4123.	
D 2 of 5	0	No options specified at this time. Always transmit 0.
	Example: A D 2 of 5 bar code 4123, is transmitted as JS0 4123	
UPC/EAN	0	Standard packet in full EAN country code format, which is 13 digits for UPC-A, UPC-E, and EAN-13 (not including supplemental data).
	1	Two-digit supplement data only.
	2	Five-digit supplement data only.
	3	Combined data packet comprising 13 digits from a UPC-A, UPC-E, or EAN-13 symbol and 2 or 5 digits from a supplemental symbol.
	4	EAN-8 data packet.
	Example: A UPC-A bar code 012345678905 is transmitted as JE000 12345678905.	
Bookland EAN	0	No options specified at this time. Always transmit 0.
	Example: A Bookland EAN bar code 123456789X is transmitted as JX0 123456789X.	
Code 11	0	Single check digit
	1	Two check digits
	3	Check characters validated but not transmitted.
	Example: A Code 11 bar code 12345678901, with one check digit enabled and transmit check digit enabled, is transmitted as JH0 12345678901.	

Appendix C Sample Bar Codes

UPC-A



UPC-E



UPC-E1



EAN-13



EAN-8



Code 39



Trioptic Code 39



456123

Code 93



12345ABCDE

Code 11



Æ1234567890Æ

Codabar



A1234567890A

MSI



Interleaved 2 of 5



Appendix D Numeric Bar Codes

0, 1, 2, 3

For parameters requiring specific numeric values, scan the appropriately numbered bar code(s).



0



1

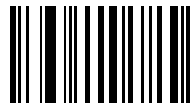

2



3

4, 5, 6, 7

For parameters requiring specific numeric values, scan the appropriately numbered bar code(s).



4



5



6



7

8, 9

For parameters requiring specific numeric values, scan the appropriately numbered bar code(s).

**8****9**

Cancel

In case of an error or to change the selection, scan the bar code below.

**Cancel**

Appendix E Alphanumeric Bar Codes

Alphanumeric Keyboard



Space

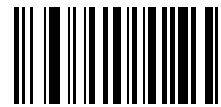

#



\$

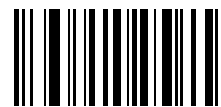

%

Alphanumeric Keyboard (continued)



*

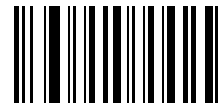

+



-

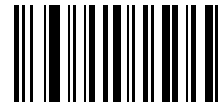

.



/



!

Alphanumeric Keyboard (continued)

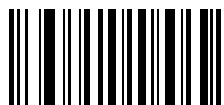

“



&

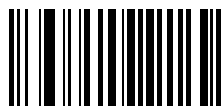

’



(

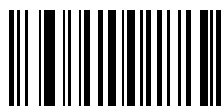

)



:

Alphanumeric Keyboard (continued)



;

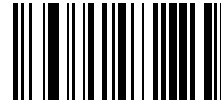

<



=

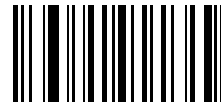

>

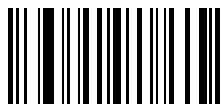

?



@

Alphanumeric Keyboard (continued)

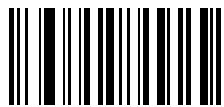

[



\



]



^

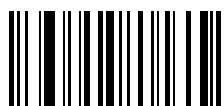

_



~

Alphanumeric Keyboard (continued)



NOTE Do not confuse the bar codes that follow with those on the numeric keypad.

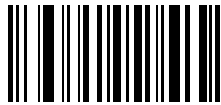

0

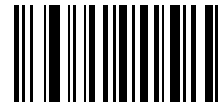

1



2

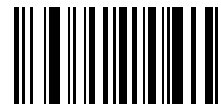

3



4

Alphanumeric Keyboard (continued)



5



6



7

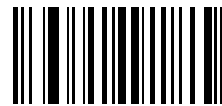

8



9



End of Message



Cancel

Alphanumeric Keyboard (continued)



A

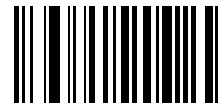

B

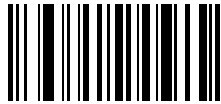

C

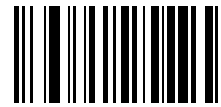

D

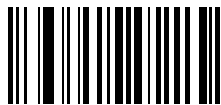

E

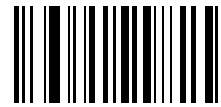

F

Alphanumeric Keyboard (continued)

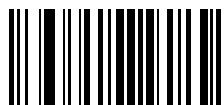

G



H



I



J



K



L

Alphanumeric Keyboard (continued)



M



N



O

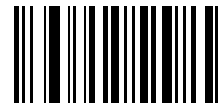

P

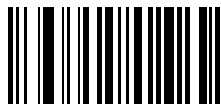

Q



R

Alphanumeric Keyboard (continued)

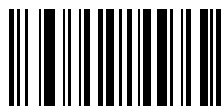

S



T

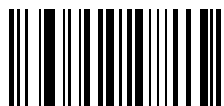

U

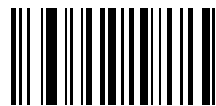

V

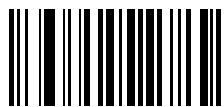

W

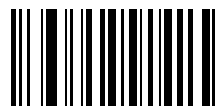

X

Alphanumeric Keyboard (continued)



Y

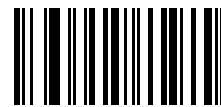

Z

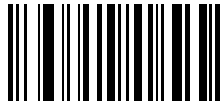

a

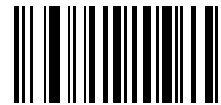

b



c



d

Alphanumeric Keyboard (continued)

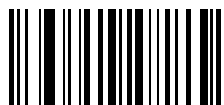

e



f

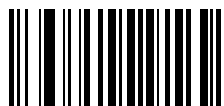

g



h

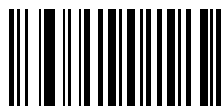

i



j

Alphanumeric Keyboard (continued)



k

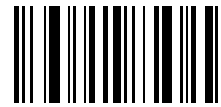

l



m

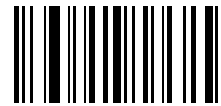

n



o

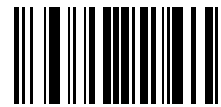

p

Alphanumeric Keyboard (continued)



q



r

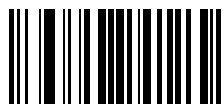

s



t



u



v

Alphanumeric Keyboard (continued)



w

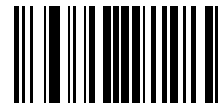

x

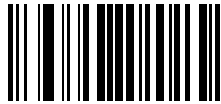

y

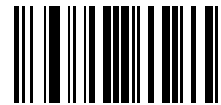

z



{



|

Alphanumeric Keyboard (continued)



}



~

Glossary

A

Aperture. The opening in an optical system defined by a lens or baffle that establishes the field of view.

ASCII. American Standard Code for Information Interchange. A 7 bit-plus-parity code representing 128 letters, numerals, punctuation marks and control characters. It is a standard data transmission code in the U.S.

Autodiscrimination. The ability of an interface controller to determine the code type of a scanned bar code. After this determination is made, the information content is decoded.

B

Bar. The dark element in a printed bar code symbol.

Bar Code. A pattern of variable-width bars and spaces which represents numeric or alphanumeric data in machine-readable form. The general format of a bar code symbol consists of a leading margin, start character, data or message character, check character (if any), stop character, and trailing margin. Within this framework, each recognizable symbology uses its own unique format. See **Symbology**.

Bar Code Density. The number of characters represented per unit of measurement (e.g., characters per inch).

Bar Height. The dimension of a bar measured perpendicular to the bar width.

Bar Width. Thickness of a bar measured from the edge closest to the symbol start character to the trailing edge of the same bar.

Bit. Binary digit. One bit is the basic unit of binary information. Generally, eight consecutive bits compose one byte of data. The pattern of 0 and 1 values within the byte determines its meaning.

Bits per Second (bps). Bits transmitted or received.

Bluetooth. A technology that provides a way to connect and exchange information between devices such as scanners, mobile phones, laptops, PCs, and printers over a secure, globally unlicensed short-range radio frequency.

Boot or Boot-up. The process a computer goes through when it starts. During boot-up, the computer can run self-diagnostic tests and configure hardware and software.

bps. See **Bits Per Second**.

Byte. On an addressable boundary, eight adjacent binary digits (0 and 1) combined in a pattern to represent a specific character or numeric value. Bits are numbered from the right, 0 through 7, with bit 0 the low-order bit. One byte in memory is used to store one ASCII character.

C

CDRH. Center for Devices and Radiological Health. A federal agency responsible for regulating laser product safety. This agency specifies various laser operation classes based on power output during operation.

CDRH Class 1. This is the lowest power CDRH laser classification. This class is considered intrinsically safe, even if all laser output were directed into the eye's pupil. There are no special operating procedures for this class.

CDRH Class 2. No additional software mechanisms are needed to conform to this limit. Laser operation in this class poses no danger for unintentional direct human exposure.

Character. A pattern of bars and spaces which either directly represents data or indicates a control function, such as a number, letter, punctuation mark, or communications control contained in a message.

Character Set. Those characters available for encoding in a particular bar code symbology.

Check Digit. A digit used to verify a correct symbol decode. The scanner inserts the decoded data into an arithmetic formula and checks that the resulting number matches the encoded check digit. Check digits are required for UPC but are optional for other symbologies. Using check digits decreases the chance of substitution errors when a symbol is decoded.

Codabar. A discrete self-checking code with a character set consisting of digits 0 to 9 and six additional characters: (- \$: / , +).

Code 128. A high density symbology which allows the controller to encode all 128 ASCII characters without adding extra symbol elements.

Code 3 of 9 (Code 39). A versatile and widely used alphanumeric bar code symbology with a set of 43 character types, including all uppercase letters, numerals from 0 to 9 and 7 special characters (- . / + % \$ and space). The code name is derived from the fact that 3 of 9 elements representing a character are wide, while the remaining 6 are narrow.

Code 93. An industrial symbology compatible with Code 39 but offering a full character ASCII set and a higher coding density than Code 39.

Code Length. Number of data characters in a bar code between the start and stop characters, not including those characters.

Cold Boot. A cold boot restarts a computer and closes all running programs.

COM Port. Communication port; ports are identified by number, e.g., COM1, COM2.

Continuous Code. A bar code or symbol in which all spaces within the symbol are parts of characters. There are no intercharacter gaps in a continuous code. The absence of gaps allows for greater information density.

Cradle. A cradle is used for charging the terminal battery and for communicating with a host computer, and provides a storage place for the terminal when not in use.

D

Dead Zone. An area within a scanner's field of view, in which specular reflection may prevent a successful decode.

Decode. To recognize a bar code symbology (e.g., UPC/EAN) and then analyze the content of the specific bar code scanned.

Decode Algorithm. A decoding scheme that converts pulse widths into data representation of the letters or numbers encoded within a bar code symbol.

Decryption. Decryption is the decoding and unscrambling of received encrypted data. Also see, **Encryption** and **Key**.

Depth of Field. The range between minimum and maximum distances at which a scanner can read a symbol with a certain minimum element width.

Discrete Code. A bar code or symbol in which the spaces between characters (intercharacter gaps) are not part of the code.

Discrete 2 of 5. A binary bar code symbology representing each character by a group of five bars, two of which are wide. The location of wide bars in the group determines which character is encoded; spaces are insignificant. Only numeric characters (0 to 9) and START/STOP characters may be encoded.

E

EAN. European Article Number. This European/International version of the UPC provides its own coding format and symbology standards. Element dimensions are specified metrically. EAN is used primarily in retail.

Element. Generic term for a bar or space.

Encoded Area. Total linear dimension occupied by all characters of a code pattern, including start/stop characters and data.

ENQ (RS-232). ENQ software handshaking is also supported for the data sent to the host.

ESD. Electro-Static Discharge

H

HID. Human Interface Device. A Bluetooth host type.

Host Computer. A computer that serves other terminals in a network, providing such services as computation, database access, supervisory programs and network control.

Hz. Hertz; A unit of frequency equal to one cycle per second.

I

IEC. International Electrotechnical Commission. This international agency regulates laser safety by specifying various laser operation classes based on power output during operation.

IEC (825) Class 1. This is the lowest power IEC laser classification. Conformity is ensured through a software restriction of 120 seconds of laser operation within any 1000 second window and an automatic laser shutdown if the scanner's oscillating mirror fails.

Intercharacter Gap. The space between two adjacent bar code characters in a discrete code.

Interleaved 2 of 5. A binary bar code symbology representing character pairs in groups of five bars and five interleaved spaces. Interleaving provides for greater information density. The location of wide elements (bar/spaces) within each group determines which characters are encoded. This continuous code type uses no intercharacter spaces. Only numeric (0 to 9) and START/STOP characters may be encoded.

Interleaved Bar Code. A bar code in which characters are paired together, using bars to represent the first character and the intervening spaces to represent the second.

Input/Output Ports. I/O ports are primarily dedicated to passing information into or out of the terminal's memory. Series 9000 mobile computers include Serial and USB ports.

I/O Ports. interface The connection between two devices, defined by common physical characteristics, signal characteristics, and signal meanings. Types of interfaces include RS-232 and PCMCIA.

K

Key. A key is the specific code used by the algorithm to encrypt or decrypt the data. Also see, **Encryption** and **Decrypting**.

L

LASER. Light Amplification by Stimulated Emission of Radiation. The laser is an intense light source. Light from a laser is all the same frequency, unlike the output of an incandescent bulb. Laser light is typically coherent and has a high energy density.

Laser Diode. A gallium-arsenide semiconductor type of laser connected to a power source to generate a laser beam. This laser type is a compact source of coherent light.

Laser Scanner. A type of bar code reader that uses a beam of laser light.

LED Indicator. A semiconductor diode (LED - Light Emitting Diode) used as an indicator, often in digital displays. The semiconductor uses applied voltage to produce light of a certain frequency determined by the semiconductor's particular chemical composition.

Light Emitting Diode. See **LED**.

M

MIL. 1 mil = 1 thousandth of an inch.

MIN. Mobile Identification Number. The unique account number associated with a cellular device. It is broadcast by the cellular device when accessing the cellular system.

Misread (Misdecode). A condition which occurs when the data output of a reader or interface controller does not agree with the data encoded within a bar code symbol.

MRD. Minimum reflective difference. A measurement of print contrast.

N

Nominal. The exact (or ideal) intended value for a specified parameter. Tolerances are specified as positive and negative deviations from this value.

Nominal Size. Standard size for a bar code symbol. Most UPC/EAN codes are used over a range of magnifications (e.g., from 0.80 to 2.00 of nominal).

O

ODI. See **Open Data-Link Interface**.

Open Data-Link Interface (ODI). Novell's driver specification for an interface between network hardware and higher-level protocols. It supports multiple protocols on a single NIC (Network Interface Controller). It is capable of understanding and translating any network information or request sent by any other ODI-compatible protocol into something a NetWare client can understand and process.

Open System Authentication. Open System authentication is a null authentication algorithm.

P

PAN . Personal area network. Using Bluetooth wireless technology, PANs enable devices to communicate wirelessly. Generally, a wireless PAN consists of a dynamic group of less than 255 devices that communicate within about a 33-foot range. Only devices within this limited area typically participate in the network.

Parameter. A variable that can have different values assigned to it.

Percent Decode. The average probability that a single scan of a bar code would result in a successful decode. In a well-designed bar code scanning system, that probability should approach near 100%.

Print Contrast Signal (PCS). Measurement of the contrast (brightness difference) between the bars and spaces of a symbol. A minimum PCS value is needed for a bar code symbol to be scannable. $PCS = (RL - RD) / RL$, where RL is the reflectance factor of the background and RD the reflectance factor of the dark bars.

Programming Mode. The state in which a scanner is configured for parameter values. See **Scanning Mode**.

Q

Quiet Zone. A clear space, containing no dark marks, which precedes the start character of a bar code symbol and follows the stop character.

QWERTY. A standard keyboard commonly used on North American and some European PC keyboards. "QWERTY" refers to the arrangement of keys on the left side of the third row of keys.

R

Reflectance. Amount of light returned from an illuminated surface.

Resolution. The narrowest element dimension which is distinguished by a particular reading device or printed with a particular device or method.

RF. Radio Frequency.

RS-232. An Electronic Industries Association (EIA) standard that defines the connector, connector pins, and signals used to transfer data serially from one device to another.

S

Scan Area. Area intended to contain a symbol.

Scanner. An electronic device used to scan bar code symbols and produce a digitized pattern that corresponds to the bars and spaces of the symbol. Its three main components are: 1) Light source (laser or photoelectric cell) - illuminates a bar code;; 2) Photodetector - registers the difference in reflected light (more light reflected from spaces); 3) Signal conditioning circuit - transforms optical detector output into a digitized bar pattern.

Scanning Mode. The scanner is energized, programmed and ready to read a bar code.

Scanning Sequence. A method of programming or configuring parameters for a bar code reading system by scanning bar code menus.

Self-Checking Code. A symbology that uses a checking algorithm to detect encoding errors within the characters of a bar code symbol.

Space. The lighter element of a bar code formed by the background between bars.

Specular Reflection. The mirror-like direct reflection of light from a surface, which can cause difficulty decoding a bar code.

SPP. Serial Port Profile.

Start/Stop Character. A pattern of bars and spaces that provides the scanner with start and stop reading instructions and scanning direction. The start and stop characters are normally to the left and right margins of a horizontal code.

Substrate. A foundation material on which a substance or image is placed.

Symbol. A scannable unit that encodes data within the conventions of a certain symbology, usually including start/stop characters, quiet zones, data characters and check characters.

Symbol Aspect Ratio. The ratio of symbol height to symbol width.

Symbol Height. The distance between the outside edges of the quiet zones of the first row and the last row.

Symbol Length. Length of symbol measured from the beginning of the quiet zone (margin) adjacent to the start character to the end of the quiet zone (margin) adjacent to a stop character.

Symbology. The structural rules and conventions for representing data within a particular bar code type (e.g. UPC/EAN, Code 39, PDF417, etc.).

T

Tolerance. Allowable deviation from the nominal bar or space width.

U

UPC. Universal Product Code. A relatively complex numeric symbology. Each character consists of two bars and two spaces, each of which is any of four widths. The standard symbology for retail food packages in the United States.

V

Visible Laser Diode (VLD). A solid state device which produces visible laser light.

Index

Numerics

123Scan 10-1

A

actions 12-2
ADF 12-1
 actions 12-1, 12-21
 move cursor 12-25
 send data 12-21
 setup fields 12-24
alphanumeric keyboard 12-86
alternate rule sets 12-3
bar code menu example 12-2
beep 12-41
code lengths 12-12
code types 12-8
criteria 12-1, 12-8
default rules 12-5
move cursor past a character 12-24
move cursor to a character 12-24
move cursor to start of data 12-24
numeric keypad 12-18, 12-19
pad spaces 12-31
pad zeros 12-36
rules 12-1
rules hierarchy 12-4
send alt characters 12-61
send control characters 12-42
send function key 12-71
send keyboard characters 12-47
send keypad characters 12-66
send preset value 12-24
send value 12-29
skip ahead "n" characters 12-24
skip ahead characters 12-26

skip back "n" characters 12-24
skip back characters 12-28
space removal 12-30
special commands 12-5
specific data string 12-16
specific string
 any location 12-17
 any message ok 12-17
 at start 12-16
 rule belongs to set 12-20
turn off rule sets 12-84, 12-85
zero removal 12-30
advanced data formatting 12-1
actions 12-1, 12-21
alphanumeric keyboard 12-86
alternate rule sets 12-3
bar code menu example 12-2
beep 12-41
code lengths 12-12
code types 12-8
criteria 12-1, 12-8
default rules 12-5
numeric keypad 12-18, 12-19
pad spaces 12-31
pad zeros 12-36
rules 12-1
rules hierarchy 12-4
send alt characters 12-61
send control characters 12-42
send function key 12-71
send keyboard characters 12-47
send keypad characters 12-66
send preset value 12-29
setup fields 12-24
skip ahead characters 12-26
skip back characters 12-28
space removal 12-30

- special commands 12-5
- specific data string 12-16
- turn off rule sets 12-84, 12-85
- zero removal 12-30
- AIM code identifiers B-2
- aiming 2-6
- ASCII character set 6-14, 7-20, 8-13
- ASCII values 7-20
- authentication 4-3, 4-27, A-2
- auto-reconnect 4-4, 4-15, 4-21, 4-24

B

- bar code defaults
 - radio communication 4-2
- bar codes
 - 123Scan 10-1
 - aim duration 5-9
 - authentication 4-27
 - auto-reconnect in Bluetooth
 - keyboard emulation (HID slave) mode 4-18
 - auto-reconnect interval 4-15
 - batch mode 5-17, 5-18
 - beep after good decode 5-7
 - beep on insertion 5-9
 - beeper tone 5-5
 - beeper volume 5-6
 - bluetooth friendly name 4-7
 - Bluetooth technology support 4-8
 - cancel D-3
 - connection maintenance interval 4-24
 - convert case 4-14
 - data options
 - pause duration 12-5
 - prefix/suffix values 5-12
 - transmit code ID character 5-11
 - discoverable mode 4-7
 - emulate keypad 4-12
 - encryption 4-29
 - FN1 substitution values 5-15
 - HID CAPS lock override 4-11
 - HID country codes 4-9
 - HID function key mapping 4-13
 - HID ignore unknown characters 4-12
 - HID keyboard FN1 substitution 4-13
 - HID keyboard keystroke delay 4-11
 - IBM 468X/469X 9-4
 - convert unknown to code 39 9-4
 - default parameters 9-3
 - port address 9-4
 - interleaved 2 of 5 11-34
 - keyboard wedge 6-4
 - alternate numeric keypad emulation 6-8

- caps lock on 6-9
- caps lock override 6-9
- convert wedge data 6-10
- country keyboard types 6-5
- default table 6-3
- FN1 substitution 6-11
- function key mapping 6-10
- host types 6-4
- ignore unknown characters 6-7
- intra-keystroke delay 6-8
- keystroke delay 6-7
 - send make and break 6-11
- laser on time 5-7
- lock override 4-22
- miscellaneous
 - FN1 substitution values 5-15
 - prefix/suffix values 5-12
 - scan angle 5-11
 - scan data options 5-13
 - Synapse interface 5-16
 - transmit code ID 5-11
 - transmit no read message 5-15
- numeric bar codes D-1
- pairing modes 4-22
- parameter broadcast 4-21
- PIN code 4-28
- prefix/suffix values 5-12
- radio communication 4-4, 4-5
 - host types 4-4, 4-5
 - pairing 4-21
- radio output power 4-21
- reconnect attempt beep 4-15
- reconnect attempt interval 4-16
- report MIMIC version 5-19
- report scan engine version 5-19
- report scanner version 5-19
- report synapse cable 5-19
- RS-232
 - baud rate 7-7
 - beep on BEL 7-17
 - beep on bel 7-17
 - check receive errors 7-10
 - data bits 7-11
 - default table 7-3
 - hardware handshaking 7-12
 - host serial response time-out 7-16
 - host types 7-6
 - ignore unknown characters 7-20
 - intercharacter delay 7-18
 - Nixdorf mode 7-19
 - parity 7-9
 - RTS line state 7-17
 - stop bits 7-11
- RS-232 parameters

- software handshaking 7-14
- sample C-1
- scan angle 5-11
- scan data options 5-13
- scanner to cradle support 4-20
- set defaults 5-4
- simulated caps lock 4-14
- symbolologies
 - bi-directional redundancy 11-51
 - bookland EAN 11-7
 - bookland ISBN 11-19
 - codabar 11-39
 - codabar CLSI editing 11-41
 - codabar lengths 11-40
 - codabar NOTIS editing 11-41
 - code 11 11-30
 - code 11 check digit verification 11-32
 - code 11 lengths 11-31
 - code 128 11-21
 - code 32 prefix 11-24
 - code 39 11-23
 - code 39 check digit verification 11-26
 - code 39 full ASCII 11-27
 - code 39 lengths 11-25
 - code 39 transmit check digit 11-26
 - code 93 11-28
 - code 93 lengths 11-28
 - convert code 39 to code 32 11-24
 - convert GS1 DataBar to UPC/EAN 11-47
 - convert UPC-E to UPC-A 11-17
 - convert UPC-E1 to UPC-A 11-17
 - default table 11-2
 - discrete 2 of 5 11-37
 - discrete 2 of 5 lengths 11-38
 - EAN zero extend 11-18
 - EAN-13 11-6
 - EAN-8 11-7
 - GS1 DataBar 11-46
 - GS1 DataBar expanded 11-47
 - GS1 DataBar limited 11-46
 - GS1 DataBar-14 11-46
 - I 2 of 5 check digit verification 11-36
 - I 2 of 5 convert to EAN-13 11-37
 - I 2 of 5 transmit check digit 11-36
 - interleaved 2 of 5 lengths 11-34
 - ISBT 128 11-22
 - MSI 11-42
 - MSI check digit algorithm 11-45
 - MSI check digits 11-44
 - MSI lengths 11-43
 - MSI transmit check digit 11-45
 - redundancy level 11-48
 - security level 11-50
 - supplementals 11-8
 - transmit code 11 check digits 11-33
 - trioptic code 39 11-23
 - UCC/EAN-128 11-22
 - UPC/EAN/JAN supp redundancy 11-12
 - UPC-A 11-5
 - UPC-A preamble 11-14
 - UPC-A/E/E1 check digit 11-12
 - UPC-E 11-5
 - UPC-E preamble 11-15
 - UPC-E1 11-6
 - UPC-E1 preamble 11-16
 - Synapse interface 5-16
 - time delay to reduced power mode 5-10
 - transmit code ID 5-11
 - transmit no read message 5-15
 - trigger mode 5-8
 - UCC coupon extended code 11-20
 - unpair 4-23
 - UPC/EAN
 - coupon code 11-20
 - USB
 - caps lock override 8-9
 - convert case 8-12
 - country keyboard types 8-6
 - default table 8-4
 - device type 8-5
 - emulate keypad 8-10
 - function key mapping 8-11
 - keyboard FN 1 substitution 8-10
 - keystroke delay 8-8
 - simulated caps lock 8-11
 - unknown characters 8-9
 - variable PIN code 4-28
 - batch mode stored data 5-17
 - battery
 - charging 1-8
 - charging problems 1-8
 - inserting 1-7
 - removing 1-8
 - beeper
 - setting tone 5-5
 - setting volume 5-6
 - beeper definitions 2-1
 - pairing 4-3
 - wireless 4-3
 - Bluetooth 1-2, 1-10
 - security 4-27
 - bluetooth keyboard emulation 4-4
 - bullets xiv

C

 - cables
 - installing 1-4

- character set 7-20, 8-13
- charging 1-8
 - LEDs 1-8
 - problems 1-8
 - via USB 1-6
- cleaning 3-1
- codabar bar codes
 - CLSI editing 11-41
 - codabar 11-39
 - lengths 11-40
 - NOTIS editing 11-41
- code 11 bar codes
 - code 11 11-30
 - lengths 11-31
- code 128 bar codes
 - code 128 11-21
 - UCC/EAN-128 11-22
- code 39 bar codes
 - check digit verification 11-26
 - code 39 11-23
 - full ASCII 11-27
 - lengths 11-25
 - transmit check digit 11-26
- code 93 bar codes
 - code 93 11-28
 - lengths 11-28
- code identifiers
 - AIM code identifiers B-2
 - Symbol code identifiers B-1
- code types
 - ADF 12-8
- configuring scanner 1-10
 - 123Scan 10-1
- connecting
 - IBM host 9-2
 - keyboard wedge 6-2
 - lost connection 1-10
 - RS-232 7-2
 - Synapse interface 1-6
 - USB 8-2
- conventions
 - notationalxiv
- cradle 1-2
 - connecting 1-4
 - diagram 1-3, 1-4
 - inserting scanner 1-9
 - mounting 1-6
 - pinouts 3-8
 - supply power 1-6

D

- decode zone 2-7
- default parameters 5-2

- IBM 468X/469X 9-3
 - keyboard wedge 6-3
 - radio communication 4-2
 - RS-232 7-3
 - standard default table A-1
 - symbologies 11-2
 - USB 8-4
 - user preferences 5-2
- discrete 2 of 5 bar codes
 - discrete 2 of 5 11-37
 - lengths 11-38

E

- encryption 4-3, 4-29, A-2
- error indications
 - miscellaneous scanner options 4-1

H

- HID Profile 4-6
- HID slave 4-4
- host types
 - keyboard wedge 6-4
 - RS-232 7-6

I

- IBM 468X/469X connection 9-2
- IBM 468X/469X default parameters 9-3
- ID 4-11
- inserting battery 1-7
- interfaces supported 1-2
- interleaved 2 of 5 bar codes
 - check digit verification 11-36
 - convert to EAN-13 11-37
 - transmit check digit 11-36
- ISBT 128 bar codes
 - ISBT 128 11-22

K

- keyboard maps 6-12
- keyboard wedge connection 6-2
- keyboard wedge default parameters 6-3

L

- LED
 - charging 1-8
 - definitions 2-4
- lock override 4-22
- locked pairing mode 4-22, 4-24
- low power mode 4-15

M

maintenance	3-1
master	4-4, 4-6, 4-15, 4-21
mounting	
cradle	1-6
MSI bar codes	
check digit algorithm	11-45
check digits	11-44
lengths	11-43
MSI	11-42
transmit check digit	11-45
multipoint-to-point communication	4-20

N

notational conventions	xiv
------------------------	-----

O

out of range indicator	4-19
------------------------	------

P

pairing	1-10
address	4-15
bar code	4-3
bar code format	4-24
beeper definitions	4-3
connection maintenance interval	4-24
cradle host	4-4
lock override	4-22
master/slave setup	4-6
methods	4-23
modes	4-2, 4-21, A-2
multipoint-to-point	4-20
on contacts	4-2, A-2
pin codes	4-28
point-to-point	4-20
radio communication	1-10
SPP	4-4
unpair	4-23
parameter defaults	
radio communication	4-2
PIN code	4-28
static	4-28
variable	4-28
pinouts	3-7
point-to-point communication	4-20
power	1-6
via USB	1-6

R

radio communication	
bar codes	4-4, 4-5
Bluetooth	1-2
Bluetooth Technology Profile support	1-10
defaults	4-2
multipoint-to-point	4-20
pairing	1-10
point-to-point	4-20
reconnect attempt	4-16
reconnect attempt beep	4-15
range indicator	4-19
reconnect attempt	4-16
beep	4-15
removing battery	1-8
RS-232	
connection	7-2
default parameters	7-3
host types	7-6
parameters	7-4

S

sample bar codes	C-1
scanner defaults	5-2
scanner to cradle support	4-20
scanning	2-5
aiming	2-5, 2-6
errors	5-2, 11-1
parameters	5-2
radio communications sequence example	4-1
selecting angle	5-11
sequence example	11-1
security level bar codes	
bi-directional redundancy	11-51
Serial Port Profile	4-6
master	4-4, 4-15, 4-21
slave	4-4
service information	xv
setup	
123Scan	10-1
connecting a USB interface	8-2
connecting an RS-232 interface	7-2
connecting keyboard wedge interface	6-2
connecting to an IBM 468X/469X host	9-2
cradle	1-2
inserting scanner in cradle	1-9
installing the cable	1-4
lost host connection	1-10
mounting cradle	1-6
scanner	1-2
supplying power	1-6
unpacking	1-2

- signal descriptions 3-7
- slave 4-4, 4-6
- specifications 3-5
- SPP 4-6
 - master 4-4, 4-15, 4-21
 - slave 4-4
- standard default parameters A-1
- standard defaults 5-2
- stored data
 - batch mode 5-17
- support xv
- Symbol code identifiers B-1
- symbology default parameters 11-2
- Synapse 1-6
 - selecting interface 5-16

T

- technical specifications 3-5
- Motorola Solutions Global
 - Customer Support Center xv
- troubleshooting 3-2

U

- unlocked pairing mode 4-22
- unpacking 1-2
- unpairing
 - bar codes 4-23
- UPC/EAN bar codes
 - bookland EAN 11-7
 - bookland ISBN 11-19
 - check digit 11-12
 - convert UPC-E to UPC-A 11-17
 - convert UPC-E1 to UPC-A 11-17
 - EAN zero extend 11-18
 - EAN-13 11-6
 - EAN-8 11-7
 - supplementals 11-8
 - UCC coupon extended code 11-20
 - UPC-A 11-5
 - UPC-A preamble 11-14
 - UPC-E 11-5
 - UPC-E preamble 11-15
 - UPC-E1 11-6
- USB
 - connection 8-2
 - default parameters 8-4
 - parameters 8-5
- user preferences bar codes
 - batch mode 5-17, 5-18
 - beep on insertion 5-9
 - time delay to reduced power mode 5-10
- user preferences parameters 5-2

Tell Us What You Think...

We'd like to know what you think about this Manual. Please take a moment to fill out this questionnaire and fax this form to: (631) 627-7184, or mail to:

Motorola Solutions, Inc.
One Motorola Plaza M/S B-10
Holtsville, NY 11742-1300
Attention: Technical Publications Manager
Data Capture Solutions Division

IMPORTANT: If you need product support, please call the appropriate customer support number provided. Unfortunately, we cannot provide customer support at the fax number above.

Manual Title: _____
(please include revision level)

How familiar were you with this product before using this manual?

- Very familiar Slightly familiar Not at all familiar

Did this manual meet your needs? If not, please explain.

What topics need to be added to the index, if applicable?

What topics do you feel need to be better discussed? Please be specific.

What can we do to further improve our manuals?

Thank you for your input—We value your comments.



MOTOROLA

Motorola Solutions, Inc.
One Motorola Plaza
Holtsville, New York 11742, USA
1-800-927-9626
<http://www.motorolasolutions.com>

MOTOROLA, MOTO, MOTOROLA SOLUTIONS and the Stylized M Logo are trademarks or registered trademarks of Motorola Trademark Holdings, LLC and are used under license. All other trademarks are the property of their respective owners.
© 2012 Motorola Solutions, Inc. All Rights Reserved



72E-93911-03 Revision A - November 2012